



2024 CATALOG



CALL TOLL FREE:

888-274-5562

WWW.BRILLMAN.COM





January 2024 Catalog

Due to volatility in both the red metal and oil markets, The Brillman Company reserves the right to adjust prices according to market conditions.

Please call toll free: 888-274-5562 for our latest pricing.

TABLE OF CONTENTS

TOOLS & SUPPLIES

SPARK PLUGS _____	2	PVC SPARK PLUG WIRE _____	23
SPARK PLUG ADAPTERS _____	2	SUPPRESSION SPARK PLUG WIRE _____	24
SPARK PLUG THUMB NUTS _____	2	BATTERY CABLE _____	24
MAGNETO THUMB NUTS _____	3	GROUND STRAPS _____	25
IGNITION BOOTS _____	3	BONDING STRAPS _____	25
SPARK PLUG TERMINALS _____	4	WIRE LOOM/CONDUIT _____	26
RAJAH TERMINALS _____	6	Asphaltic, Expandable, Split, Galvanize, Steel, & Stainless Steel Wire Loom/Conduit	
BATTERY TERMINALS _____	8	GAUGES _____	27
BATTERY CABLE LUGS _____	8	SWITCHES & KNOBS _____	28
Standard, Flag, & GM Old Style		STARTER SWITCHES _____	30
BATTERY TERMINAL/LUG ACCESORIES _____	9	SOLENOIDS _____	31
Bolt/Nuts, Terminal Covers, Lug Covers, Harness Assemblies		MASTER SWITCHES _____	37
HEAT SHRINK/ HOOK-UP TERMINALS _____	10	DASH LAMPS _____	37
FAHNESTOCK CLIPS/ Packard 56 Terminals _____	11	FLASHERS _____	38
FUSE HOLDERS _____	12	AUXILIARY PLUGS _____	38
SEMI-TAILORED SPARK PLUG WIRE SETS _____	13	REPAIR KIT _____	38
COTTON BRAIDED PRIMARY WIRE _____	14	IDENTIFICATION TAGS _____	38
ARMOR COVERED PRIMARY WIRE _____	19	ALTERNATORS _____	39
PVC PRIMARY WIRE _____	19	ALTERNATOR PULLEYS _____	41
COTTON BRAIDED SPARK PLUG WIRE _____	23	ALT. BRACKETS/ FUEL ACCESSORIES _____	43
		IGNITION COILS _____	44

TRACTOR & INDUSTRIAL

ALLIS CHALMERS _____	45	JOHN BLUE _____	223
AVERY, B.F. AVERY & SONS _____	66	JOHN DEERE _____	224
BEST _____	73	JOHN DEERE LAWN & GARDEN _____	304
BOBCAT _____	73	KOHLER _____	305
BRIGGS & STRATTON _____	73	LEADER _____	306
BUDA ENGINES _____	73	LEYLAND _____	306
CASE _____	74	LINCOLN WELDER _____	307
CASE SKID STEER _____	94	LONG _____	310
CATERPILLAR _____	95	MASSEY FERGUSON _____	311
CENTAUR _____	103	MASSEY HARRIS _____	326
CHRYSLER INDUSTRIAL _____	103	MAYTAG _____	342
CLETRAC _____	104	MINNEAPOLIS MOLINE _____	343
COCKSHUTT/ CO-OP _____	106	MUSTANG _____	361
CONTINENTAL ENGINES _____	118	NUFFIELD _____	361
CUSTOM _____	122	OLIVER _____	362
EMPIRE _____	125	ROCK ISLAND/ HEIDER _____	384
FORD TRACTOR _____	126	RUMELY OIL PULL _____	384
GIBSON _____	144	SHAW DO-ALL _____	384
GRAHAM BRADLEY _____	145	SILVER KING _____	384
GRAVELY _____	147	STANDARD TWIN _____	387
GRAY MARINE ENGINES _____	148	TWIN CITY _____	388
HART PARR _____	148	WALLIS _____	388
HERCULES ENGINES _____	149	WATERLOU BRONCO _____	388
HOUGH PAYLOADER _____	150	WAUKESHA ENGINES _____	389
HUBER _____	151	WICO EK MAGNETOS _____	389
IHC/FARMALL/McCORMICK DEERING _____	152	WISCONSIN _____	390
IHC GAS ENGINES _____	218	WORTHINGTON _____	403
IHC CUB CADET/ LAWN & GARDEN _____	219		

AUTOMOTIVE & TRUCK

AMERICAN LAFRANCE	404
AUBURN	405
AUTOCAR TRUCK	407
BANTAM (AMERICAN & AUSTIN)	409
BUICK CAR	410
BUICK TRUCK	416
CADILLAC	416
CAMERON	421
CHECKER	421
CHEVROLET CAR	422
CHEVROLET TRUCK	429
CHRYSLER & IMPERIAL	434
CLEVELAND	443
CORBITT TRUCK	443
CROFTON BUG	444
CROSLEY	444
DESOTO	446
DIAMOND T	451
DODGE CAR	452
DODGE TRUCK	462
DORRIS	468
DURANT	468
ESSEX	468
FEDERAL TRUCK	468
FORD CAR	470
FORD TRUCK	477
FRANKLIN	480
FRAZER	482
GMC TRUCK	482
GRAHAM/ GRAHAM-PAIGE	487
HENRY J.	490

HUDSON CAR	492
HUDSON TRUCK	496
HUPMOBILE	497
IHC TRUCK	499
JEWETT	505
KAISER-FRAZER	506
LAFAYETTE	507
LASALLE	508
LINCOLN	509
MACK TRUCK	510
MARMON	515
MARQUETTE	515
MERCURY	515
METROPOLITAN	519
MG	520
NASH	520
OAKLAND	528
OLDSMOBILE	531
OVERLAND	536
PACKARD	537
PIERCE ARROW	545
PLYMOUTH	546
PONTIAC	553
REO CAR & TRUCK	559
ROCKNE	560
ROLLS ROYCE	560
SCRIPPS-BOOTH	561
STUDEBAKER	562
WILLYS & JEEP	566
WILLYS KNIGHT	569
WILLYS OVERLAND WHIPPET	569

MOTORCYCLE & SCOOTER

HARLEY-DAVIDSON	570
INDIAN	571
VINCENT	571

MARINE

INBOARD & OUTBOARD ENGINES

ELGIN (CHRYSLER) OUTBOARD	572
FORD	572
OMC	572

WARRANTY

Terms and Conditions	1
----------------------	---

MAIL ORDERS

ORDER FORM	573
------------	-----

Our Mission

At the Brillman Company, we specialize in wiring & electrical components for your antique farm tractors & automotive vehicles.

We offer a wide selection of wire harnesses, battery cables, spark plug wire sets, proudly made in the USA, & most anything electrical for farm equipment manufacturers, such as **Allis Chalmers, Case, Cockshutt/Co-op, Ford, IHC/Farmall, John Deere, Massey Fergusson, Massey Harris, & Oliver**, along with automotive manufacturers that include **Buick, Cadillac, Chevrolet, Dodge, Ford, GMC, Mack, Pontiac, & Plymouth**.

We believe that a job well done ends with a satisfied customer. Therefore, we offer many custom services to better suit your restoration purposes. Call our toll free number for more information on custom services, such as custom braided wire.

We are dedicated to getting your electrical repair or restoration project completed.

We even offer after-the-sale technical expertise for products that were purchased from us.

With over 200 years combined experience, our knowledge & help are second to none.

Please Note

**Due to volatility in both the red metal and oil markets,
The Brillman Company reserves the right
to adjust prices according to market conditions.
Please call toll free: 888-274-5562 for our latest pricing.**

Warranty

Terms and Conditions

--Shipping & Handling Charge: All Shortages Must Be Reported Within 10 Days of Receipt! 20% Restocking Fee on Returned Items. No Returns after 90 Days Unless Defective, No Returns on Cut Wire, Wire Loom, Installed Parts, or Custom-Made Parts. Warranties are limited 1 replacement within the warranty period. THE BRILLMAN COMPANY Makes No Warranty of Merchantability or of Fitness for any Particular Purpose and Makes No or Implied Warranties in Selling the Products Described Herein. A Buyer's Recovery for Damages Resulting from any and all Whatsoever, Including but not Limited to, Breach of Contract, Breach of Warranty, Negligence, or Strict Product Liability, Will be Exclusively Limited to the Replacement of the Products with Respect to which Losses or Damages are Claimed or to a Refund of any Purchase Price Paid for the Products. In No Event Will The Brillman Company be Liable to any Buyer or User of the Products for Incidental or Consequential Damages or for any Other Damages to the Property or Person of the Buyer or User. Buyer Specifically Acknowledges that He has not Relied Upon, Nor has Seller Made any Representations that this Product as Suitable for any Particular Application or Use

SPARK PLUGS



1/2" Pipe Thread

Part #	Description	Price
I-25	Auburn 1/2" pipe thread (1.72" reach)	\$54.25
I-64-4	Auburn 1/2" pipe thread (1.12" reach)	\$48.00
X (425)	Champion 1/2" pipe thread (Original old style 2 piece take apart with black finish & brass top)	\$48.75
#25	Champion 1/2" pipe thread	\$21.75
F11	Motorcraft 1/2" pipe thread	\$7.00
3095	Autolite 1/2" pipe thread	\$4.50

7/8" SAE Thread

Part #	Description	Price
3X	Champion 7/8" SAE thread (Original old style 2 piece take apart with black finish & brass top)	\$48.75
W14	Champion 7/8" SAE thread	\$9.50
W16Y	Champion 7/8" SAE thread	\$10.75
W18	Champion 7/8" SAE thread, 3/4" Reach	\$9.50
W20	Champion 7/8" SAE thread, .625" Reach	\$10.50
W89D	Champion 7/8" SAE thread, long electrode	\$12.50
TT10	Motorcraft 7/8" SAE thread	\$19.75
3076	Autolite 7/8" SAE thread	\$4.50

18mm Thread

Part #	Description	Price
D14	Champion 18mm thread	\$4.25
D16	Champion 18mm thread	\$4.25
UD16	Champion 18mm thread	\$6.30
D18Y	Champion 18mm thread Projected Tip	\$4.25
D21	Champion 18mm thread	\$4.25
D23	Champion 18mm thread, 5/8" Reach	\$10.25
D89D	Champion 18mm thread, 1.03" Reach	\$19.00
C87	AC Delco 18mm thread	\$4.94
C88L	AC Delco 18mm thread, 9/16" Reach	\$6.75
386	Autolite 18mm thread	\$3.50
3116	Autolite 18mm thread Projected Tip	\$4.50
388	Autolite 18mm thread 9/16" Reach	\$3.25

CT481	Spark Plug Gap Gauge	\$4.50
-------	----------------------	--------

14mm Thread

Part #	Description	Price
H10C	Champion 14mm thread	\$3.25
H12	Champion 14mm thread	\$3.85
J8C	Champion 14mm thread	\$3.00
J11C	Champion 14mm thread	\$3.00
RH18Y	Champion 14mm thread	\$3.25
RJ12C	Champion 14mm thread	\$3.25
RJ18YC	Champion 14mm thread (#58)	\$3.25
C45L	A-C 14mm thread	\$3.00
R43XLS	AC Delco 14mm thread	\$3.00
R44XLS	AC Delco 14mm thread	\$2.75
R45XLS	AC Delco 14mm thread	\$3.00
216	Autolite 14mm thread	\$3.50
295	Autolite 14mm thread	\$3.50
306	Autolite 14mm thread	\$3.00
458	Autolite 14mm thread	\$3.00

10mm Thread

Part #	Description	Price
UY6	Champion 10mm thread	\$6.50
M8	A-C 10mm thread	\$4.75
3136	Autolite 10mm thread	\$3.00

SPARK PLUG ADAPTERS



Made of Solid Brass

Part #	Description	Price
B9005-001	1/2" Pipe to 14mm Gasket Seat	\$10.75
B9005-002	18mm to 14mm Gasket Seat	\$13.50
B9005-003	7/8" SAE to 14mm Gasket Seat	\$15.50
B9005-004	3/4" Pipe to 1/2" Pipe	\$11.75



SPARK PLUG THUMB NUTS

8-32S	Brass Spark Plug Thumb Nut	(See prices below)	
Replacement Nuts for Champion X & 3x Plugs. Used On All Champion 7/8" & 1/2" Spark Plugs, As Well As Older Plugs			
M4S	Brass Spark Plug Thumb Nut	(See prices below)	
For Modern Type Spark Plugs such as Autolite #3076, 3077, 3095, Motorcraft #T10, F-11 & Many Other New Manufacture Spark Plugs. Made To Look Like Exact Replacement Nuts For Champion X & 3x			
8-32B	Large Brass Thumb Nut	(See prices below)	
For Buzz Coils & Battery Boxes 8-32 Thread 7/16" Diameter			
Qty 1-9	\$0.83	Qty 100-499	\$0.50
Qty 10-25	\$0.67	Qty. 500-999	\$0.44
Qty 26-99	\$0.53	Qty. 1000+	\$0.39

MAGNETO THUMB NUTS

	#8-32BN	Bakelite Magneto Nut #8-32 Thread	\$6.95
	#10-32BN	Bakelite Magneto Nut #10-32 Thread	\$2.00

IGNITION BOOTS

For Spark Plugs, Distributors, Magnets, & Coils

Spark Plug Boots

	B9003-001 Straight Spark Plug Boot for 7 & 8 mm Wire	
	Qty 1-9	\$1.25
	Qty 10-25	\$1.00
	Qty 26-99	\$0.85
	Qty 100-499	\$0.77
	Qty. 500-999`	\$0.67
	Qty. 1000+	\$0.62

	B9003-002 Right Angle Spark Plug / Distributor Boot With Ribs for 7 & 8 mm Wire	
	Qty 1-9	\$1.25
	Qty 10-25	\$1.00
	Qty 26-99	\$0.85
	Qty 100-499	\$0.77
	Qty. 500-999`	\$0.67
	Qty. 1000+	\$0.62

	B9003-003 \$2.00	
	Old Style Small Right Angle Spark Plug Boot Includes Spring Type Ignition Terminal. Old Style "Sparky" Ignition Terminal & Boot Assembly For 7mm Wire. Commonly used on Small Engines such as Chain Saws & Lawn mowers.	

	B9003-009 Right Angle Spark Plug Boot For 7 & 8 mm Wire	
	Qty 1-9	\$1.25
	Qty 10-25	\$1.00
	Qty 26-99	\$0.85
	Qty 100-499	\$0.77
	Qty. 500-999`	\$0.67
	Qty. 1000+	\$0.62

	B9003-010 115° Degree Spark Plug Boot	
	Qty 1-9	\$2.30
	Qty 10-25	\$1.96
	Qty 26-99	\$1.73
	Qty 100-499	\$1.61
	Qty. 500-999`	\$1.50
	Qty. 1000+	\$1.38

Distributor/Magneto Boots

	B9003-004 Old Style Rajah Type Straight Distributor/Magneto Boot (Antique Design)	
	Qty 1-9	\$1.25
	Qty 10-25	\$1.00
	Qty 26-99	\$0.85
	Qty 100-499	\$0.77
	Qty. 500-999`	\$0.67
	Qty. 1000+	\$0.62

	B9003-005 Straight Distributor/Magneto Boot	
	Qty 1-9	\$1.25
	Qty 10-25	\$1.00
	Qty 26-99	\$0.85
	Qty 100-499	\$0.77
	Qty. 500-999`	\$0.67
	Qty. 1000+	\$0.62

	B9003-008 Right Angle Distributor/Magneto Boot	
	Qty 1-9	\$1.25
	Qty 10-25	\$1.00
	Qty 26-99	\$0.85
	Qty 100-499	\$0.77
	Qty. 500-999`	\$0.67
	Qty. 1000+	\$0.62

	B9003-002 Right Angle Spark Plug / Distributor Boot With Ribs for 7 & 8 mm Wire	
	Qty 1-9	\$1.25
	Qty 10-25	\$1.00
	Qty 26-99	\$0.85
	Qty 100-499	\$0.77
	Qty. 500-999`	\$0.67
	Qty. 1000+	\$0.62

Coil Boots







	B9003-007 Old Style Rajah Type Straight Coil Boot (Antique Design)	
	Qty 1-9	\$1.25
	Qty 10-25	\$1.00
	Qty 26-99	\$0.85
	Qty 100-499	\$0.77
	Qty. 500-999`	\$0.67
	Qty. 1000+	\$0.62

	B9003-006 Straight Coil Boot	
	Qty 1-9	\$1.25
	Qty 10-25	\$1.00
	Qty 26-99	\$0.85
	Qty 100-499	\$0.77
	Qty. 500-999`	\$0.67
	Qty. 1000+	\$0.62

B9003-011	Modern Style Straight Coil Boot with Neck	
	Qty 1-9	\$1.25
	Qty 10-25	\$1.00
	Qty 26-99	\$0.85
	Qty 100-499	\$0.77
	Qty. 500-999`	\$0.67
	Qty. 1000+	\$0.62
B9003-013	90 Degree HEI type Distributor Boot With Latch for Wire Retainer	
	Qty 1-9	\$1.25
	Qty 10-25	\$1.00
	Qty 26-99	\$0.85
	Qty 100-499	\$0.77
	Qty. 500-999`	\$0.67
	Qty. 1000+	\$0.62
B9003-012	135 Degree LS type Coil Boot	
	Qty 1-9	\$2.30
	Qty 10-25	\$1.96
	Qty 26-99	\$1.73
	Qty 100-499	\$1.61
	Qty. 500-999`	\$1.50
	Qty. 1000+	\$1.38
B9003-014	90 Degree LS type Coil Boot	
	Qty 1-9	\$2.30
	Qty 10-25	\$1.96
	Qty 26-99	\$1.73
	Qty 100-499	\$1.61
	Qty. 500-999`	\$1.50
	Qty. 1000+	\$1.38
B9003-015	Right Angle Coil Boot	
	Qty 1-9	\$1.25
	Qty 10-25	\$1.00
	Qty 26-99	\$0.85
	Qty 100-499	\$0.77
	Qty. 500-999`	\$0.67
	Qty. 1000+	\$0.62
B9003-016	Ford Distributor Boot For 3-Cylinder Models, 1965 and newer. Replaces: DHPN12259A (spark plug wire set)	
	Qty 1-9	\$2.30
	Qty 10-25	\$1.96
	Qty 26-99	\$1.73
	Qty 100-499	\$1.61
	Qty. 500-999`	\$1.50
	Qty. 1000+	\$1.38

SPARK PLUG TERMINALS

7mm Ignition Terminals

OHT	Old Style Straight High Tension Distributor/Coil Terminal	
	Qty 1-9	\$0.45
	Qty 10-25	\$0.35
	Qty 26-99	\$0.20
	Qty 100-499	\$0.18
	Qty. 500-999`	\$0.17
	Qty. 1000+	\$0.16
SHT	Solder Type High Tension Distributor/Coil Terminal	
	Qty 1-9	\$0.50
	Qty 10-25	\$0.40
	Qty 26-99	\$0.25
	Qty 100-499	\$0.23
	Qty. 500-999`	\$0.22
	Qty. 1000+	\$0.21
BHT	Modern (Better) Distributor/Coil Terminal	
	Qty 1-9	\$0.45
	Qty 10-25	\$0.35
	Qty 26-99	\$0.30
	Qty 100-499	\$0.27
	Qty. 500-999`	\$0.23
	Qty. 1000+	\$0.21
B9019-004	Modern Right Angle Distributor/Coil Terminal	
	Qty 1-9	\$0.45
	Qty 10-25	\$0.35
	Qty 26-99	\$0.30
	Qty 100-499	\$0.27
	Qty. 500-999`	\$0.23
	Qty. 1000+	\$0.21
	Works with 7mm Wire & 8mm Wire	
STCRPLT	Old Style Straight Crimp Spark Plug Terminal	
	Qty 1-9	\$0.45
	Qty 10-25	\$0.35
	Qty 26-99	\$0.30
	Qty 100-499	\$0.27
	Qty. 500-999`	\$0.23
	Qty. 1000+	\$0.21
BSTCRPLT	Better Straight Crimp Spark Plug Terminal	
	Qty 1-9	\$0.45
	Qty 10-25	\$0.35
	Qty 26-99	\$0.30
	Qty 100-499	\$0.27
	Qty. 500-999`	\$0.23
	Qty. 1000+	\$0.21

RACRPLT	Old Style Right Angle Crimp Spark Plug Terminal	
	Qty 1-9	\$0.45
	Qty 10-25	\$0.35
	Qty 26-99	\$0.30
	Qty 100-499	\$0.27
	Qty. 500-999	\$0.23
	Qty. 1000+	\$0.21

BRACRPLT	Better Right Angle Crimp Spark Plug Terminal	
	Qty 1-9	\$0.45
	Qty 10-25	\$0.35
	Qty 26-99	\$0.30
	Qty 100-499	\$0.27
	Qty. 500-999	\$0.23
	Qty. 1000+	\$0.21

135CRPLT	135° Crimp Spark Plug Terminal	
	Qty 1-9	\$0.45
	Qty 10-25	\$0.35
	Qty 26-99	\$0.30
	Qty 100-499	\$0.27
	Qty. 500-999	\$0.23
	Qty. 1000+	\$0.21

SP116	Copper Straight Ford Type Spark Plug Terminal	
	Qty 1-9	\$1.00
	Qty 10-25	\$0.71
	Qty 26-99	\$0.62
	Qty 100-499	\$0.56
	Qty. 500-999	\$0.49
	Qty. 1000+	\$0.45

SP119	Brass Solder Type Thrust (Forked) Spark Plug Terminal	
	Qty 1-9	\$1.00
	Qty 10-25	\$0.71
	Qty 26-99	\$0.62
	Qty 100-499	\$0.56
	Qty. 500-999	\$0.49
	Qty. 1000+	\$0.45

SP120	Brass Thrust (Forked) Spark Plug Terminal	
	Qty 1-9	\$1.00
	Qty 10-25	\$0.71
	Qty 26-99	\$0.62
	Qty 100-499	\$0.56
	Qty. 500-999	\$0.49
	Qty. 1000+	\$0.45

SP120A	Nickel Plated Brass Thrust (Forked) Spark Plug Terminal	
	Qty 1-9	\$1.00
	Qty 10-25	\$0.71
	Qty 26-99	\$0.62
	Qty 100-499	\$0.56
	Qty. 500-999	\$0.49
	Qty. 1000+	\$0.45

SP121A	Nickel Plated Brass Ring Spark Plug Terminal	
	Qty 1-9	\$1.00
	Qty 10-25	\$0.71
	Qty 26-99	\$0.62
	Qty 100-499	\$0.56
	Qty. 500-999	\$0.49
	Qty. 1000+	\$0.45

SP121	Brass Ring Spark Plug Terminal	
	Qty 1-9	\$1.00
	Qty 10-25	\$0.71
	Qty 26-99	\$0.62
	Qty 100-499	\$0.56
	Qty. 500-999	\$0.49
	Qty. 1000+	\$0.45









SP104	Brass Eye Spark Plug Terminal	
	Qty 1-9	\$1.00
	Qty 10-25	\$0.71
	Qty 26-99	\$0.62
	Qty 100-499	\$0.56
	Qty. 500-999	\$0.49
	Qty. 1000+	\$0.45

BEE	Brass Ring Crimp Spark Plug / Magneto Terminal	
	Qty 1-9	\$0.45
	Qty 10-25	\$0.35
	Qty 26-99	\$0.30
	Qty 100-499	\$0.27
	Qty. 500-999	\$0.23
	Qty. 1000+	\$0.21

8mm Ignition Terminals

B9019-001	(Better) Straight Crimp Spark Plug Terminal	
	Qty 1-9	\$0.45
	Qty 10-25	\$0.35
	Qty 26-99	\$0.30
	Qty 100-499	\$0.27
	Qty. 500-999	\$0.23
	Qty. 1000+	\$0.21

B9019-002	(Better) Right Angle Crimp Spark Plug Terminal	
	Qty 1-9	\$0.45
	Qty 10-25	\$0.35
	Qty 26-99	\$0.30
	Qty 100-499	\$0.27
	Qty. 500-999	\$0.23
	Qty. 1000+	\$0.21
B9019-003	135° Crimp Spark Plug Terminal	
	Qty 1-9	\$0.45
	Qty 10-25	\$0.35
	Qty 26-99	\$0.30
	Qty 100-499	\$0.27
	Qty. 500-999	\$0.23
	Qty. 1000+	\$0.21
B9019-004	Modern Right Angle Distributor/Coil Terminal	
	Qty 1-9	\$0.45
	Qty 10-25	\$0.35
	Qty 26-99	\$0.30
	Qty 100-499	\$0.27
	Qty. 500-999	\$0.23
	Qty. 1000+	\$0.21
	Works with 7mm Wire & 8mm Wire	
B9019-005	LS Type Crimp Coil Terminal used with Our LS Boots # B9003-012 (135 deg), B9003-014 (90 deg)	
	Qty 1-9	\$0.45
	Qty 10-25	\$0.35
	Qty 26-99	\$0.30
	Qty 100-499	\$0.27
	Qty. 500-999	\$0.23
	Qty. 1000+	\$0.21

	R2	\$1.50
	Nickel Plated Brass Rajah Ring Terminal	
	R2B	\$2.00
	Brass Rajah Ring Terminal	
	SR	\$1.50
	Split Ring Rajah Terminal	
	HTS	\$3.75
	Nickel Plated Brass Rajah Hook	
	HTSB	\$3.75
	Brass Rajah Hook Terminal	
	SS	\$1.50
	Nickel Plated Brass Rajah Straight Snap Cage Terminal	
	ASS	\$1.50
	Nickel Plated Brass Rajah Angle Snap Cage Terminal	
	RAC	\$1.50
	Nickel Plated Brass Rajah Right Angle Cage Terminal	

RAJAH TERMINALS

Rajah Crimp Style Terminals

For 7mm Wire. *Note:* cannot be used with #B9938-xxx, 7.8mm Cotton Braid Spark Plug Wire

	TT	\$1.50
	Nickel Plated Brass Rajah Thrust (Forked) Terminal	
	TTB	\$2.00
	Brass Rajah Thrust (Forked) Terminal	

	CT	\$1.50
	Nickel Plated Brass Rajah Straight Cage Terminal (Ford Type)	

Rajah Screw Type Terminals

For 7mm Wire. Note: cannot be used with Suppression wire

Rajah Screw Type Terminals (*Prices for All*)			
Qty 1-9	\$4.20	Qty 100-499	\$2.73
Qty 10-25	\$3.36	Qty. 500-999	\$2.42
Qty 26-99	\$3.05	Qty. 1000+	\$2.10

	T-SOS	(See prices above)
	Thrust (Forked) Nickel Plated Brass With Bakelite Barrel Screw Together Terminal	

	TSN	(See prices above)
	Thrust (Forked) Nickel Plated Brass Screw Together Terminal	

	R-SOS	(See prices above)
	Ring Nickel Plated Brass With Bakelite Barrel Screw Together Terminal	

	RSN	(See prices above)
	Ring Nickel Plated Brass Screw Together Terminal	

	SS-SOS	(See prices above)
	Straight Snap Cage Nickel Plated Brass With Bakelite Barrel Screw Together Terminal	

	SSN	(See prices above)
	Straight Snap Cage Nickel Plated Brass Screw Together Terminal	

	AS-SOS	(See prices above)
	Right Angle Snap Cage Nickel Plated Brass With Bakelite Barrel Screw Together Terminal	

	ASN	(See prices above)
	Right Angle Snap Cage Nickel Plated Brass Screw Together Terminal	

	HTS-SOS	(See prices above)
	Hook Brass With Bakelite Barrel Screw Together Terminal	

	EBF	(See prices above)
	Straight Snap Cage Nickel Plated Brass With Bakelite Cover Screw Together Terminal	

	AEBF	(See prices above)
	Right Angle Snap Cage Nickel Plated Brass with Bakelite Cover Screw Together Terminal	

9mm Ignition Terminals

B9019-006	Old Style Straight High Tension			
	Qty 1-9	\$1.00	Qty 100-499	\$0.56
	Qty 10-25	\$0.71	Qty. 500-999	\$0.49
	Qty 26-99	\$0.62	Qty. 1000+	\$0.45

T5026T	Ford Model T Ring Spark Plug Terminal			
	Qty 1-9	\$1.00	Qty 100-499	\$0.56
	Qty 10-25	\$0.71	Qty. 500-999	\$0.49
	Qty 26-99	\$0.62	Qty. 1000+	\$0.45

SP111	Brass Solder Type Thrust (Locking) Spark Plug Terminal			
	Qty 1-9	\$1.00	Qty 100-499	\$0.56
	Qty 10-25	\$0.71	Qty. 500-999	\$0.49
	Qty 26-99	\$0.62	Qty. 1000+	\$0.45

SP112	Brass Solder Type Thrust (Forked) Spark Plug Terminal			
	Qty 1-9	\$1.00	Qty 100-499	\$0.56
	Qty 10-25	\$0.71	Qty. 500-999	\$0.49
	Qty 26-99	\$0.62	Qty. 1000+	\$0.45

SP104	Brass Eye Spark Plug Terminal			
	Qty 1-9	\$1.00	Qty 100-499	\$0.56
	Qty 10-25	\$0.71	Qty. 500-999	\$0.49
	Qty 26-99	\$0.62	Qty. 1000+	\$0.45

BEE	Brass Ring Crimp Spark Plug / Magneto Terminal			
	Qty 1-9	\$0.45	Qty 100-499	\$0.27
	Qty 10-25	\$0.35	Qty. 500-999	\$0.23
	Qty 26-99	\$0.30	Qty. 1000+	\$0.21

BATTERY TERMINALS



Straight Battery Terminals

Tin-Plated, Cast Copper.
Can Be Soldered Or Crimped.

4 GA Battery Cable Terminals

B2102T	Straight Universal	\$5.75
B2103T	Straight Negative	\$5.75
B2104T	Straight Positive	\$5.75

1 & 2 GA Battery Cable Terminals

B2106T	Straight Universal	\$5.75
B2108T	Straight Positive	\$5.75
B2107T	Straight Negative	\$5.75

1/0 GA Battery Cable Terminals

B2110T	Straight Positive	\$5.75
B2109T	Straight Negative	\$5.75

2/0 GA Battery Cable Terminals

B2112T	Straight Positive	\$5.75
B2111T	Straight Negative	\$5.75

3/0 GA Battery Cable Terminals

B2114T	Straight Positive	\$5.75
B2113T	Straight Negative	\$5.75



Flag Battery Terminals (Right Hand Shown)

Tin-Plated, Cast Copper.
Can Be Soldered Or Crimped.

1 & 2 GA Battery Terminals

B2407T	Left Hand Flag Universal	\$5.75
B2307T	Right Hand Flag Universal	\$5.75

1/0 GA Battery Cable Terminals

B2410T	Left Hand Flag Positive	\$5.75
B2409T	Left Hand Flag Negative	\$5.75
B2310T	Right Hand Flag Positive	\$5.75
B2309T	Right Hand Flag Negative	\$5.75

2/0 GA Battery Cable Terminals

B2412T	Left Hand Flag Positive	\$5.75
B2411T	Left Hand Flag Negative	\$5.75
B2312T	Right Hand Flag Positive	\$5.75
B2311T	Right Hand Flag Negative	\$5.75

3/0 GA Battery Cable Terminals

B2414T	Left Hand Flag Positive	\$5.75
B2413T	Left Hand Flag Negative	\$5.75
B2314T	Right Hand Flag Positive	\$5.75
B2313T	Right Hand Flag Negative	\$5.75



Tee Type Battery Terminal

Tin-Plated, Cast Copper.
Can Be Soldered Or Crimped.

1/0 GA Battery Cable Terminals

B2210T	Tee Positive	\$7.00
B2209T	Tee Negative	\$7.00

2/0 GA Battery Cable Terminals

B2212T	Tee Positive	\$7.00
B2211T	Tee Negative	\$7.00

3/0 GA Battery Cable Terminals

B2214T	Tee Positive	\$7.00
B2213T	Tee Negative	\$7.00

Lead Battery Terminals

	1401	\$1.50
Temporary Top Post Battery Terminal for 8 GA to 2/0 GA Cable		

	1411	\$2.25
Temporary Top Post Battery Terminal for 2 GA to 4/0 GA Cable		

	1506	\$1.25
Temporary Top Post Marine Battery Terminal		

	B05317	\$2.50
Ordinance (Military) Battery Terminal		

BATTERY CABLE LUGS



Standard Type

All Terminals Are Made of Copper &
Can Be Soldered or Crimped.

6 GA Battery Cable Lug

B1812	5/16" Hole	\$0.75
B1813	3/8" Hole	\$0.75

4 GA Battery Cable Lug

B1821	1/4" Hole	\$0.75
B1822	5/16" Hole	\$0.75
B1823	3/8" Hole	\$0.75
B1824	1/2" Hole	\$0.75

2 GA Battery Cable Lug

B1842	5/16" Hole	\$1.50
B1843	3/8" Hole	\$1.50
B1844	1/2" Hole	\$1.50

1 GA Battery Cable Lug

B1832	5/16" Hole	\$1.50
B1833	3/8" Hole	\$1.50
B1834	1/2" Hole	\$1.50

1/0 GA Battery Cable Lug

B1852	5/16" Hole	\$1.75
B1853	3/8" Hole	\$1.75
B1854	1/2" Hole	\$1.75

2/0 GA Battery Cable Lug

B1862	5/16" Hole	\$2.25
B1863	3/8" Hole	\$2.25
B1864	1/2" Hole	\$2.25

3/0 GA Battery Cable Lug

B1873	3/8" Hole	\$2.50
B1874	1/2" Hole	\$2.50

GM Type Old Style

2 GA Battery Cable Lug

	B9012-001	\$4.50
Early GM Style Battery Cable Lug (3/8" Hole)		



Flag Type

All Terminals Are Made of Tin-Plated Copper & Can Be Soldered or Crimped

4 GA Battery Cable Lug

BF-38-F	3/8" Hole	\$3.00
----------------	-----------	---------------

2 GA Battery Cable Lug

BG-38-F	3/8" Hole	\$3.25
----------------	-----------	---------------

1/0 GA Battery Cable Lug

BH-38-F	3/8" Hole	\$4.50
----------------	-----------	---------------

2/0 GA Battery Cable Lug

BJ-38-F	3/8" Hole	\$5.75
----------------	-----------	---------------

BATTERY TERMINAL BOLTS

	B2501-001	\$0.40
Battery Terminal Bolt/Nut		

	B2501-002	\$3.25
Battery Bolt Extender		

Battery Terminal/ Boot Covers



Straight

B06102	Black 1/2 GA	\$2.25
B06103	Red 1/2 GA	\$2.25
B06104	Black 1/0-2/0 GA	\$2.25
B06105	Red 1/0-2/0 GA	\$2.25



Flag (T)

B06106	Black 2/0 GA	\$2.75
B06107	Red 2/0 GA	\$2.75



Elbow

B06108	Black 2/0 GA Right	\$2.75
B06109	Red 2/0 GA Right	\$2.75
B06110	Black 2/0 GA Left	\$2.75
B06111	Red 2/0 GA Left	\$2.75

B06115	Red 2 GA Right	\$2.75
B06116	Black 2 GA Left	\$2.75
B06119	Red 4-8 GA Right	\$2.75
B06121	Red 4-8 GA Left	\$2.75

Battery Lug Covers



THSDS-1B	Black #1/2 GA	\$2.25
THSDS-1R	Red #1/2 GA	\$2.25
THSDS-100B	Black #1/0 GA	\$2.25
THSDS-100R	Red #1/0 GA	\$3.75

THSDS-4B	Black #4/0 GA	\$2.25
-----------------	---------------	---------------

B37701	Red Connector Cover, 50 Series	\$2.00
---------------	--------------------------------	---------------

Battery Harness Assemblies



2-Battery Harness, 7"

B04362	Red (Group 31)	\$16.52
B04363	Black (Group 31)	\$16.52



3-Battery Harness, 14"

B04364	Red (Group 31)	\$30.81
B04365	Black (Group 31)	\$30.81



4-Battery Harness, 21"

B04662	Red (Group 31)	\$41.00
B04663	Black (Group 31)	\$41.00

Solder Pellets Used to Solder Battery Cable



B36230	#4 GA Cable	\$0.75
B36231	#2 GA Cable	\$1.25
B36232	#1 GA Cable	\$1.50
B36233	#1/0 GA Cable	\$2.00
B36234	#2/0 GA Cable	\$2.25
B36235	#3/0 GA Cable	\$2.50

Heat Shrink



.3" Inside Diameter Heat Shrink

Used to Seal 10 thru 16 GA Wire

Cut to 3/4" Length		
B9999.75	Black	\$0.40
B9999.75R	Red	\$0.40

(Bulk) Sold By The Foot		
B999912	Black	\$4.75
B999912R	Red	\$4.75

.75" Inside Diameter Heat Shrink

Used to Seal Battery Cable

Cut To 1.25" Length		
B22212.75	Black	\$0.50
B22212.75R	Red	\$0.50

(Bulk) Sold By The Foot		
B2221212	Black	\$4.75
B2221212R	Red	\$4.75

HOOK-UP TERMINALS & CONNECTORS FOR PRIMARY WIRE



Ring Terminals

Non-Insulated, Tin-Plated Copper

14/16 GA Ring Terminals		(#6 thru 3/8") \$0.20	
B9004-001	#6 Terminal	B9004-004	1/4" Terminal
B9004-002	#8 Terminal	B9004-005	5/16" Terminal
B9004-003	#10 Terminal	B9004-006	3/8" Terminal
B9004-007	1/2" Terminal	\$0.40	

10/12 GA Ring Terminals		(#8 thru 3/8") \$0.20	
B9004-008	#8 Terminal	B9004-011	5/16" Terminal
B9004-009	#10 Terminal	B9004-012	3/8" Terminal
B9004-010	1/4" Terminal	\$0.40	
B9004-013	1/2" Terminal	\$0.40	

8 GA Ring Terminals		(#10 thru 3/8") \$0.60	
B9004-038	#10 Terminal	B9004-051	5/16" Terminal
B9004-039	1/4" Terminal	B9004-040	3/8" Terminal
B9004-041	1/2" Terminal	\$0.80	

6 GA Ring Terminals		(#10 thru 1/4") \$0.80	
B9004-046	#10 Terminal	B9004-047	1/4" Terminal

B9004-048	3/8" Terminal	(#3/8 thru 5/16") \$0.90	
B9004-049	1/2" Terminal	B9004-050	5/16" Terminal

Flag (Right Angle) Ring Terminals

	B9004-014	\$0.40
	14/16 GA x #10 Flag Ring Terminal	
	B9004-015	\$0.40
	10/12 GA x #10 Flag Ring Terminal	



Spade Terminals

Non-Insulated, Tin-Plated Copper

Spade Terminals

	B9004-016	14/16 GA x #10	\$0.20
	B9004-071	14/16 GA x #6	\$0.20
	B9004-017	10/12 GA x #10	\$0.20

Locking Spade Terminals

	B9004-018	\$0.20
	14/16 GA x #10 Locking Spade Terminal	
	B9004-019	\$0.20
	10/12 GA x #10 Locking Spade Terminal	

Flag (Right Angle) Spade Terminals

	B9004-021	\$0.40
	10/12 GA x #10 Flag Spade Terminal	
	B9004-020	\$0.40
	14/16 GA x #10 Flag Spade Terminal	
B9004-070	18/22 GA x #10 Flag Terminal	\$0.40

1/4" Quick Disconnect Terminals

	B9004-022	\$0.20
	14/16 GA x 1/4" Male Quick Disconnect	
	B9004-023	\$0.20
	10/12 GA x 1/4" Male Quick Disconnect	

B9004-043	GM Quick Disconnect			
	Qty 1-9	\$4.20	Qty 100-499	\$2.73
	Qty 10-25	\$3.36	Qty. 500-999	\$2.42
	Qty 26-99	\$3.05	Qty. 1000+	\$2.10

	B9004-056	\$0.75
	1/4" 2-Way Male Quick Disconnect	

	B9004-057	\$3.50
	1/4" 3-Way Male Quick Disconnect	

	B9004-024	\$0.20
	14/16 GA x 1/4" Female Quick Disconnect	
	B9004-025	\$0.20
	10/12 GA x 1/4" Female Quick Disconnect	

	B9004-026	\$0.20
	14/16 GA x 1/4" Female Flag Quick Disconnect	
	B9004-027	\$0.20
10/12 GA x 1/4" Female Flag Quick Disconnect		



1/4" Quick Disconnect Terminal Adaptor

	B9004-042	\$0.20
	1/4" Male Disconnect #10 Stud Adaptor	

Bullet Terminals

.156 Male Bullet Terminals

Top Quality, Machined From Solid Brass

B9004-028	14/16 GA x .156 Male Bullet Terminal			
	Qty 1-9	\$0.83	Qty 100-499	\$0.50
	Qty 10-25	\$0.67	Qty. 500-999	\$0.44
	Qty 26-99	\$0.56	Qty. 1000+	\$0.39
B9004-029	12 GA x .156 Male Bullet Terminal			
	Qty 1-9	\$1.31	Qty 100-499	\$0.77
	Qty 10-25	\$1.05	Qty. 500-999	\$0.67
	Qty 26-99	\$0.87	Qty. 1000+	\$0.59

.156 Female Bullet Connectors

B9004-035	for Single Wire, Original Type			
	Qty 1-9	\$3.25	Qty 100-499	\$1.95
	Qty 10-25	\$2.54	Qty. 500-999	\$1.66
	Qty 26-99	\$2.17	Qty. 1000+	\$1.52
	B9004-036			\$0.50
	for Single Wire, Modern Type			
	B9004-037			\$5.25
	for 1 Into 2 Wire			
B9004-055	Triple Female Connector			
	Qty 1-9	\$6.82	Qty 100-499	\$4.10
	Qty 10-25	\$5.33	Qty. 500-999	\$3.50
	Qty 26-99	\$4.55	Qty. 1000+	\$3.20

.180 Male Bullet Terminals

Top Quality, Machined From Solid Brass

B9004-030	14/16 GA x .180 Male Bullet Terminal			
	Qty 1-9	\$0.83	Qty 100-499	\$0.50
	Qty 10-25	\$0.67	Qty. 500-999	\$0.44
	Qty 26-99	\$0.56	Qty. 1000+	\$0.39

.180 Female Bullet Connectors Insulated, Ford Type

B9004-031	for Single Wire			
B9004-032	for 2 Into 2 Wire			
	Qty 1-9	\$1.31	Qty 100-499	\$0.77
	Qty 10-25	\$1.05	Qty. 500-999	\$0.67
	Qty 26-99	\$0.87	Qty. 1000+	\$0.59

Uninsulated Butt Connectors

	B9004-044	\$0.20
	14/16 Gauge Uninsulated Butt Connector	
	B9004-045	\$0.20
10/12 Gauge Uninsulated Butt Connector		

Fahnestock Clips

B9004-053	Small Fahnestock Clip (Bronze)			
	Qty 1-9	\$1.75	Qty 100-499	\$1.05
	Qty 10-25	\$1.36	Qty. 500-999	\$0.90
	Qty 26-99	\$1.16	Qty. 1000+	\$0.81
B9004-054	Large Fahnestock Clip (Bronze)			
	Qty 1-9	\$3.25	Qty 100-499	\$1.95
	Qty 10-25	\$2.54	Qty. 500-999	\$1.66
	Qty 26-99	\$2.17	Qty. 1000+	\$1.52

Wire Separators

B9034-006	7mm or 8mm Wire (Set of 6)	\$9.75
------------------	----------------------------	---------------

Packard 56 Series Terminals

Delphi / Aptiv: All are 56 Series unless otherwise stated.

B9004-058	14/16 GA Male	Replaces: #2971962		
B9004-059	12 GA Male	Replaces:#2971859		
	Qty 1-9	\$0.83	Qty 100-499	\$0.50
	Qty 10-25	\$0.67	Qty. 500-999	\$0.44
	Qty 26-99	\$0.56	Qty. 1000+	\$0.39
B9004-060	14/16 GA Female (56 Series) Replaces: #2965142, 2965867			
B9004-095	14/16 GA Female (*59 Series*) Replaces: #2973216			
B9004-061	12 GA Female Replaces: #2965143, 2989877			
	Qty 1-9	\$1.00	Qty 100-499	\$0.56
	Qty 10-25	\$0.71	Qty. 500-999	\$0.49
	Qty 26-99	\$0.62	Qty. 1000+	\$0.45
B9004-063	10 GA Female Replaces:#6288913			
	Qty 1-9	\$2.30	Qty 100-499	\$1.61
	Qty 10-25	\$1.96	Qty. 500-999	\$1.50
	Qty 26-99	\$1.73	Qty. 1000+	\$1.38

Packard 56 Series Connectors

B9004-064	1-Cavity Female Replaces: #2977253			
B9004-065	1-Cavity Female (Long) Replaces: #2973453			
B9004-097	1-Cavity Male Replaces: #2984528			
B9004-072	2-Cavity Male Replaces: #2984883, Mates w/ #B9004-067			
	Qty 1-9	\$1.00	Qty 100-499	\$0.56
	Qty 10-25	\$0.71	Qty. 500-999	\$0.49
	Qty 26-99	\$0.62	Qty. 1000+	\$0.45

B9004-073	2-Cavity Male (Parallel) Replaces: #2973431, Mates w/ #B9004-074			
	Qty 1-9	\$5.88	Qty 100-499	\$3.67
	Qty 10-25	\$4.90	Qty. 500-999	\$3.30
	Qty 26-99	\$4.18	Qty. 1000+	\$3.00

B9004-076	2-Cavity for Delco 10DN Alternators Replaces: #2977373			
	Qty 1-9	\$0.83	Qty 100-499	\$0.50
	Qty 10-25	\$0.67	Qty. 500-999	\$0.44
	Qty 26-99	\$0.56	Qty. 1000+	\$0.39

B9004-075	2-Cavity for Delco 10SI Alternators Replaces: #6294493			
	Qty 1-9	\$1.00	Qty 100-499	\$0.56
	Qty 10-25	\$0.71	Qty. 500-999	\$0.49
	Qty 26-99	\$0.62	Qty. 1000+	\$0.45

	B9004-091			\$8.50
	2-Cavity Female (Separated) Replaces: #2965809			

B9004-066	2-Cavity Female (Flasher) Replaces: #2973385 (*See Prices Below*)			
------------------	---	--	--	--

B9004-067	2-Cavity Female (Mated) Replaces: #2973781, Mates w/ #B9004-072			
------------------	---	--	--	--

B9004-074	2-Cavity Female (Parallel) Replaces: #2973407, Mates w/ #B9004-073			
------------------	--	--	--	--

B9004-092	2-Cavity Female (Stacked) Replaces: #2973872			
------------------	--	--	--	--

B9004-093	3-Cavity Female (Packard 59 Series) Replaces: #2965810			
	Qty 1-9	\$0.83	Qty 100-499	\$0.50
	Qty 10-25	\$0.67	Qty. 500-999	\$0.44
	Qty 26-99	\$0.56	Qty. 1000+	\$0.39

B9004-078	3-Cavity Female (with Long Clip) Replaces: #2984378, Mates w/ #B9004-077			
------------------	--	--	--	--

B9004-081	3-Cavity Female (Parallel) Replaces: #2984958			
	Qty 1-9	\$2.30	Qty 100-499	\$1.61
	Qty 10-25	\$1.96	Qty. 500-999	\$1.50
	Qty 26-99	\$1.73	Qty. 1000+	\$1.38

	B9004-079			\$8.75
	3-Cavity Female for Voltage Regulators Replaces: #2965164			

B9004-080	3-Cavity Female (Triangular) Replaces: #2962510, Mates w/ #B9004-096			
------------------	--	--	--	--

B9004-077	3-Cavity Male (Triangular) Replaces: #2984678, Mates w/ #B9004-078			
	Qty 1-9	\$1.31	Qty 100-499	\$0.77
	Qty 10-25	\$1.05	Qty. 500-999	\$0.67
	Qty 26-99	\$0.87	Qty. 1000+	\$0.59

	B9004-082			\$8.75
	3-Cavity Male (with Long Clip) Replaces: #2984887			

B9004-083	4-Cavity Female Replaces: #2977048			
	Qty 1-9	\$1.75	Qty 100-499	\$1.05
	Qty 10-25	\$1.36	Qty. 500-999	\$0.90
	Qty 26-99	\$1.16	Qty. 1000+	\$0.81

B9004-096	3-Cavity Male Replaces: #2973172, Mates w/ #B9004-080			
------------------	---	--	--	--

B9004-068	4-Cavity Male Replaces: #6294544			
	Qty 1-9	\$2.30	Qty 100-499	\$1.61
	Qty 10-25	\$1.96	Qty. 500-999	\$1.50
	Qty 26-99	\$1.73	Qty. 1000+	\$1.38

B9004-086	4-Cavity for 10DN Alternators Replaces: #2977607			
	Qty 1-9	\$3.25	Qty 100-499	\$1.95
	Qty 10-25	\$2.54	Qty. 500-999	\$1.66
	Qty 26-99	\$2.17	Qty. 1000+	\$1.52

B9004-087	5-Cavity Female Replaces: #2973422			
------------------	---	--	--	--

B9004-088	6-Cavity Female Replaces: #2977607			
	Qty 1-9	\$1.31	Qty 100-499	\$0.77
	Qty 10-25	\$1.05	Qty. 500-999	\$0.67
	Qty 26-99	\$0.87	Qty. 1000+	\$0.59



B9004-084	6-Cavity Female (Angled) Replaces: #2984017			
	Qty 1-9	\$2.30	Qty 100-499	\$1.61
	Qty 10-25	\$1.96	Qty. 500-999	\$1.50
	Qty 26-99	\$1.73	Qty. 1000+	\$1.38

B9004-089	6-Cavity Male Replaces: #2977042			
------------------	--	--	--	--

B9004-090	8-Cavity Female Replaces: #2965977			
	Qty 1-9	\$1.75	Qty 100-499	\$1.05
	Qty 10-25	\$1.36	Qty. 500-999	\$0.90
	Qty 26-99	\$1.16	Qty. 1000+	\$0.81

B9004-085	8-Cavity Male Replaces: #2965972			
	Qty 1-9	\$2.30	Qty 100-499	\$1.61
	Qty 10-25	\$1.96	Qty. 500-999	\$1.50
	Qty 26-99	\$1.73	Qty. 1000+	\$1.38

Fuse Holders

	B9004-033	\$7.50
	Panel Fuse Holder	
	B9004-034	\$2.50
	Bakelite Inline Fuse Holder without Wire for Inserting Custom Color Wire	

SEMI-TAILORED SPARK PLUG WIRE SETS



Original Type is Cotton Braid Wire with a Copper Core.
Modern Type (M) is PVC Wire with a Copper Core.
EPDM Wire (E) is a Hi Performance Premium Copper Conductor with a Tinned Copper Core and EPDM Silicone Insulation.
Suppression Wire (S) is for Electronic Ignition and is Spiral Wound, Low-Ohm, with EPDM Silicone Insulation.
Cotton Braid Suppression Wire (CS) is also for Electronic Ignition and is Spiral Wound, Low-Ohm, with EPDM Silicone Insulation.

1-Cylinder Semi-Tailored Set		
Cable #1 Length: 30", Coil Length: 18"		
B1000-006	Original Type (Satin Black)	\$7.25
B1000-006M	Modern Type	\$9.00
B1000-006E	EPDM Wire	\$9.00
B1000-006S	Suppression Wire	\$9.00
B1000-006CS	Cotton Braid Suppression Wire	\$13.75

2-Cylinder Semi-Tailored Set		
Cable #1 Length: 30", Cable #2 Length: 21", Coil Length: 13"		
B1000-001	Original Type (Satin Black)	\$13.25
B1000-001M	Modern Type	\$16.00
B1000-001E	EPDM Wire	\$16.00
B1000-001S	Suppression Wire	\$16.00
B1000-001CS	Cotton Braid Suppression Wire	\$25.50

3-Cylinder Semi-Tailored Set		
Cable #1 Length: 30", Cable #2 Length: 21", Cable #3 Length: 18", Coil Length: 18"		
B1000-002	Original Type (Satin Black)	\$21.00
B1000-002M	Modern Type	\$25.50
B1000-002E	EPDM Wire	\$25.50
B1000-002S	Suppression Wire	\$25.50
B1000-002CS	Cotton Braid Suppression Wire	\$40.00

4-Cylinder Semi-Tailored Set		
Cable #1 Length: 30", Cable #2 Length: 24", Cable #3 Length: 18", Cable #4 Length: 18", Coil Length: 18"		
B1000-003	Original Type (Satin Black)	\$25.50
B1000-003M	Modern Type	\$30.75
B1000-003E	EPDM Wire	\$30.75
B1000-003S	Suppression Wire	\$30.75
B1000-003CS	Cotton Braid Suppression Wire	\$48.25

6-Cylinder Semi-Tailored Set, Right Angle Terminals		
Cable #1 Length: 30.5", Cable #2 Length: 30.5", Cable #3 Length: 24.5", Cable #4 Length: 24.5", Cable #5 Length: 18.5", Cable #6 Length: 18.5", Coil Length: 18"		
B1000-004	Original Type (Glossy Black)	\$42.50
B1000-004M	Modern Type	\$51.00
B1000-004E	EPDM Wire	\$51.00
B1000-004S	Suppression Wire	\$51.00
B1000-004CS	Cotton Braid Suppression Wire	\$80.75

6-Cylinder Semi-Tailored Set, Straight Terminals		
Cable #1 Length: 30.5", Cable #2 Length: 30.5", Cable #3 Length: 24.5", Cable #4 Length: 24.5", Cable #5 Length: 18.5", Cable #6 Length: 18.5", Coil Length: 18"		
B1000-014	Original Type (Glossy Black)	\$42.50
B1000-014M	Modern Type	\$51.00
B1000-014E	EPDM Wire	\$51.00
B1000-014S	Suppression Wire	\$51.00
B1000-014CS	Cotton Braid Suppression Wire	\$80.75

8-Cylinder Semi-Tailored Set, Right Angle Terminals		
Cable 1 Length: 48", Cable 2 Length: 48", Cable 3 Length: 30.5", Cable 4 Length: 30.5", Cable 5 Length: 24.5", Cable 6 Length: 24.5", Cable 7 Length: 18.5", Cable 8 Length: 18.5", Coil Length: 12"		
B1000-005	Original Type (Glossy Black)	\$62.25
B1000-005M	Modern Type	\$75.00
B1000-005E	EPDM Wire	\$75.00
B1000-005S	Suppression Wire	\$75.00
B1000-005CS	Cotton Braid Suppression Wire	\$118.25

8-Cylinder Semi-Tailored Set, Straight Terminals		
Cable 1 Length: 48", Cable 2 Length: 48", Cable 3 Length: 30.5", Cable 4 Length: 30.5", Cable 5 Length: 24.5", Cable 6 Length: 24.5", Cable 7 Length: 18.5", Cable 8 Length: 18.5", Coil Length: 12"		
B1000-015	Original Type (Glossy Black)	\$62.25
B1000-015M	Modern Type	\$75.00
B1000-015E	EPDM Wire	\$75.00
B1000-015S	Suppression Wire	\$75.00
B1000-015CS	Cotton Braid Suppression Wire	\$118.25

COPPER WIRE



We proudly produce all of our cloth-covered wire & cable entirely in the US.

COTTON BRAID PRIMARY WIRE (HOOK UP WIRE)

Lacquer Covered Cotton Braid over PVC Insulation to Look Like Old Stock!

Rated at 60 Volts DC. For Automotive and Tractor use only.



#B9901-xxx 18 Ga. Cotton Braid Primary Wire

10 Feet = \$10.00	25 Feet = \$15.25	50 Feet = \$26.75	100 Feet = \$39.25	500 Feet = \$184.00
-----------------------------	-----------------------------	-----------------------------	------------------------------	-------------------------------

Choose Color From List Below

B9901-001	Natural (White)
B9901-006	Natural (White) with (2) Black Parallel Tracers
B9901-120	Natural (White) with (2) Green Parallel Tracers
B9901-009	Gray
B9901-011	Yellow
B9901-018	Yellow with (2) Black Parallel Tracers
B9901-026	Orange (Oak) with Red & Black Cross Tracers
B9901-110	Orange (Oak) with (1) Black Tracer
B9901-029	Blue
B9901-031	Blue with (2) White Tracers
B9901-036	Green
B9901-121	Green with (2) White Parallel Tracers

B9901-040	Green with (2) Black Parallel Tracers
B9901-039	Green with (1) Orange Tracer
B9901-042	Red
B9901-044	Red with (2) White Parallel Tracers
B9901-046	Red with (2) Yellow Parallel Tracers
B9901-049	Red with (2) Black Parallel Tracers
B9901-050	Brown
B9901-052	Brown with (2) Black Parallel Tracers
B9901-053	Brown with (2) White Parallel Tracers
B9901-056	Brown with Red & Black Cross Tracers
B9901-058	Black
B9901-060	Black with (2) White Parallel Tracers
B9901-072	Black with (2) Red Parallel Tracers



#B9902-xxx 16 Ga. Cotton Braid Primary Wire

10 Feet = \$11.50	25 Feet = \$18.00	50 Feet = \$31.25	100 Feet = \$46.25	500 Feet = \$216.00
----------------------	----------------------	----------------------	-----------------------	------------------------

Choose Color From List Below

B9902-001	Natural (White)
B9902-160	Natural (White) with (1) Blue Tracer
B9902-002	Natural (White) with Blue Cross Tracers
B9902-116	Natural (White) with (1) Green Tracer
B9902-120	Natural (White) with (2) Green Parallel Tracers
B9902-003	Natural (White) with Green Cross Tracers
B9902-115	Natural (White) with (1) Red Tracer
B9902-004	Natural (White) with Red Cross Tracers
B9902-119	Natural (White) with (2) Red Parallel Tracers
B9902-117	Natural (White) with (2) Brown Parallel Tracers
B9902-005	Natural (White) with (1) Black Tracer
B9902-006	Natural (White) with (2) Black Parallel Tracers
B9902-007	Natural (White) with Black Cross Tracers
B9902-114	Natural (White) with Black & Green Cross Tracers
B9902-008	Natural (White) with Red & Black Cross Tracers
B9902-009	Gray
B9902-010	Gray with (2) Black Parallel Tracers
B9902-011	Yellow
B9902-012	Yellow with (2) Blue Parallel Tracers
B9902-013	Yellow with (1) Green Tracer
B9902-014	Yellow with (2) Green Parallel Tracers
B9902-016	Yellow with (2) Red Parallel Tracers
B9902-074	Yellow with Red & Black Cross Tracers
B9902-017	Yellow with (1) Black Tracer
B9902-018	Yellow with (2) Black Parallel Tracers
B9902-020	Yellow with Black Cross Tracers
B9902-021	Yellow with Blue & Red Cross Tracers
B9902-022	Yellow with Blue & Black Cross Tracers
B9902-151	Lemon Yellow
B9902-112	Lemon Yellow with (1) Black Tracer
B9902-023	Orange (Oak)
B9902-024	Orange (Oak) with (2) Black Parallel Tracers
B9902-026	Orange (Oak) with Red & Black Cross Tracers
B9902-027	Pink
B9902-028	Purple (Violet)
B9902-029	Blue
B9902-030	Blue with (1) White Tracer
B9902-031	Blue with (2) White Parallel Tracers
B9902-032	Blue with (1) Yellow Tracer
B9902-033	Blue with (2) Yellow Parallel Tracers

B9902-034	Blue with (2) Red Parallel Tracers
B9902-035	Dark Blue
B9902-036	Green
B9902-037	Green with (1) White Tracer
B9902-121	Green with (2) White Parallel Tracers
B9902-038	Green with (2) Yellow Parallel Tracers
B9902-039	Green with (1) Orange Tracer
B9902-040	Green with (2) Black Parallel Tracers
B9902-149	Olive Green
B9902-130	Olive Green with (1) White Tracer
B9902-042	Red
B9902-043	Red with (1) White Tracer
B9902-044	Red with (2) White Parallel Tracers
B9902-132	Red with (1) Yellow Tracer
B9902-046	Red with (2) Yellow Parallel Tracers
B9902-047	Red with (2) Blue Parallel Tracers
B9902-048	Red with (2) Green Parallel Tracers
B9902-133	Red with (1) Black Tracer
B9902-049	Red with (2) Black Parallel Tracers
B9902-050	Brown
B9902-051	Brown with (1) Black Tracer
B9902-052	Brown with (2) Black Parallel Tracers
B9902-053	Brown with (2) White Parallel Tracers
B9902-054	Brown with (2) Green Parallel Tracers
B9902-055	Brown with (2) Red Parallel Tracers
B9902-056	Brown with Red & Black Cross Tracers
B9902-057	Brown with Black & White Cross Tracers
B9902-058	Black
B9902-059	Black with (1) White Tracer
B9902-060	Black with (2) White Parallel Tracers
B9902-061	Black with (3) White Parallel Tracers
B9902-062	Black with White Cross Tracers
B9902-063	Black with (1) Yellow Tracer
B9902-064	Black with (2) Yellow Parallel Tracers
B9902-075	Black with Yellow Cross Tracers
B9902-065	Black with (2) Orange Parallel Tracers
B9902-066	Black with (2) Blue Parallel Tracers
B9902-069	Black with (2) Green Parallel Tracers
B9902-070	Black with Green Cross Tracers
B9902-071	Black with (1) Red Tracer
B9902-072	Black with (2) Red Parallel Tracers
B9902-073	Black with Red Cross Tracers



#B9903-xxx 14 Ga. Cotton Braid Primary Wire

10 Feet = \$14.25	25 Feet = \$22.50	50 Feet = \$39.25	100 Feet = \$57.25	500 Feet = \$268.50
----------------------	----------------------	----------------------	-----------------------	------------------------

Choose Color From List Below

B9903-001	Natural (White)
B9903-002	Natural (White) with Blue Cross Tracers
B9903-003	Natural (White) with Green Cross Tracers
B9903-120	Natural (White) with (2) Green Parallel Tracers
B9903-004	Natural (White) with Red Cross Tracers
B9903-119	Natural (White) with (2) Red Parallel Tracers
B9903-005	Natural (White) with (1) Black Tracer
B9903-006	Natural (White) with (2) Black Parallel Tracers
B9903-007	Natural (White) with Black Cross Tracers
B9903-008	Natural (White) with Red & Black Cross Tracers
B9903-009	Gray
B9903-011	Yellow
B9903-012	Yellow with (2) Blue Parallel Tracers
B9903-013	Yellow with (1) Green Tracer
B9903-014	Yellow with (2) Green Parallel Tracers
B9903-016	Yellow with (2) Red Parallel Tracers
B9903-074	Yellow with Red & Black Cross Tracers
B9903-018	Yellow with (2) Black Parallel Tracers
B9903-021	Yellow with Blue & Red Cross Tracers
B9903-023	Orange (Oak)
B9903-024	Orange (Oak) with (2) Black Parallel Tracers
B9903-025	Orange (Oak) with (3) Black Parallel Tracers
B9903-026	Orange (Oak) with Red & Black Cross Tracers
B9903-028	Purple (Violet)
B9903-029	Blue
B9903-031	Blue with (2) White Parallel Tracers
B9903-033	Blue with (2) Yellow Parallel Tracers
B9903-034	Blue with (2) Red Parallel Tracers
B9903-035	Dark Blue
B9903-036	Green
B9903-037	Green with (1) White Tracer
B9903-038	Green with (2) Yellow Parallel Tracers
B9903-121	Green with (2) White Parallel Tracers
B9903-040	Green with (2) Black Parallel Tracers
B9903-161	Olive Green with (2) White Parallel Tracers

B9903-042	Red
B9903-043	Red with (1) White Tracer
B9903-044	Red with (2) White Parallel Tracers
B9903-046	Red with (2) Yellow Parallel Tracers
B9903-047	Red with (2) Blue Parallel Tracers
B9903-048	Red with (2) Green Parallel Tracers
B9903-049	Red with (2) Black Parallel Tracers
B9903-050	Brown
B9903-052	Brown with (2) Black Parallel Tracers
B9903-053	Brown with (2) White Parallel Tracers
B9903-054	Brown with (2) Green Parallel Tracers
B9903-055	Brown with (2) Red Parallel Tracers
B9903-056	Brown with Red & Black Cross Tracers
B9903-057	Brown with Black & White Cross Tracers
B9903-058	Black
B9903-059	Black with (1) White Tracer
B9903-060	Black with (2) White Parallel Tracers
B9903-061	Black with (3) White Parallel Tracers
B9903-062	Black with White Cross Tracers
B9903-063	Black with (1) Yellow Tracer
B9903-064	Black with (2) Yellow Parallel Tracers
B9903-075	Black with Yellow Cross Tracers
B9903-065	Black with (2) Orange Parallel Tracers
B9903-066	Black with (2) Blue Parallel Tracers
B9903-067	Black with Blue Cross Tracers
B9903-068	Black with (1) Green Tracer
B9903-069	Black with (2) Green Parallel Tracers
B9903-070	Black with Green Cross Tracers
B9903-071	Black with (1) Red tracer
B9903-072	Black with (2) Red Parallel Tracers
B9903-073	Black with Red Cross Tracers



#B9904-xxx 12 Ga. Cotton Braid Primary Wire

10 Feet = \$18.75	25 Feet = \$29.25	50 Feet = \$49.00	100 Feet = \$76.75	500 Feet = \$360.00
----------------------	----------------------	----------------------	-----------------------	------------------------

Choose Color From List Below

B9904-001	Natural (White)
B9904-003	Natural (White) with Green Cross Tracers
B9904-004	Natural (White) with Red Cross Tracers
B9904-005	Natural (White) with (1) Black Tracer
B9904-006	Natural (White) with (2) Black Parallel Tracers
B9904-007	Natural (White) with Black Cross Tracers
B9904-008	Natural (White) with Red & Black Cross Tracers
B9904-009	Gray
B9904-011	Yellow
B9904-013	Yellow with (1) Green Tracer
B9904-014	Yellow with (2) Green Parallel Tracers
B9904-015	Yellow with (1) Red Tracer
B9904-074	Yellow with Red & Black Cross Tracers
B9904-017	Yellow with (1) Black Tracer
B9904-018	Yellow with (2) Black Parallel Tracers
B9904-019	Yellow with (3) Black Parallel Tracers
B9904-023	Orange (Oak)
B9904-024	Orange (Oak) with (2) Black Parallel Tracers
B9904-025	Orange (Oak) with (3) Black Parallel Tracers
B9904-026	Orange (Oak) with Red & Black Cross Tracers
B9904-029	Blue
B9904-030	Blue with (1) White Tracer
B9904-143	Blue with (3) White Tracers

B9904-036	Green
B9904-040	Green with (2) Black Parallel Tracers
B9904-076	Green with (3) White Parallel Tracers
B9904-042	Red
B9904-044	Red with (2) White Parallel Tracers
B9904-045	Red with (3) White Parallel Tracers
B9904-046	Red with (2) Yellow Parallel Tracers
B9904-049	Red with (2) Black Parallel Tracers
B9904-050	Brown
B9904-163	Brown with (3) White Parallel Tracers
B9904-054	Brown with (2) Green Parallel Tracers
B9904-055	Brown with (2) Red Parallel Tracers
B9904-056	Brown with (1) Black Tracer
B9904-057	Brown with Black & White Cross Tracers
B9904-058	Black
B9904-060	Black with (2) White Parallel Tracers
B9904-061	Black with (3) White Parallel Tracers
B9904-062	Black with White Cross Tracers
B9904-064	Black with (2) Yellow Parallel Tracers
B9904-065	Black with (2) Orange Parallel Tracers
B9904-066	Black with (2) Blue Parallel Tracers
B9904-070	Black with Green Cross Tracers
B9904-073	Black with Red Cross Tracers



#B9905-xxx 10 Ga. Cotton Braid Primary Wire

10 Feet = \$26.50	25 Feet = \$41.75	50 Feet = \$70.75	100 Feet = \$107.75	500 Feet = \$504.00
-----------------------------	-----------------------------	-----------------------------	-------------------------------	-------------------------------

Choose Color From List Below

B9905-001	Natural (White)
B9905-004	Natural (White) with Red Cross Tracers
B9905-007	Natural (White) with Black Cross Tracers
B9905-008	Natural (White) with Black & Red Cross Tracers
B9905-011	Yellow
B9905-016	Yellow with (2) Red Parallel Tracers
B9905-074	Yellow with Red & Black Cross Tracers
B9905-017	Yellow with (1) Black Tracer
B9905-018	Yellow with (2) Black Parallel Tracers
B9905-024	Orange (Oak) with (2) Black Parallel Tracers
B9905-026	Orange (Oak) with Red & Black Cross Tracers
B9905-036	Green

B9905-040	Green with (2) Black Parallel Tracers
B9905-041	Green with Red Cross Tracers
B9905-042	Red
B9905-049	Red with (2) Black Parallel Tracers
B9905-050	Brown
B9905-051	Brown with (1) Black Tracer
B9905-058	Black
B9905-065	Black with (2) Orange Parallel Tracers
B9905-072	Black with (2) Red Parallel Tracers
B9905-148	Black with (4) White Parallel Tracers



#B9906-xxx 8 Ga. Cotton Braid Primary Wire

10 Feet = \$48.75	25 Feet = \$69.50	50 Feet = \$117.75	100 Feet = \$180.00	500 Feet = \$843.75
-----------------------------	-----------------------------	------------------------------	-------------------------------	-------------------------------

Choose Color From List Below

B9906-036	Green
B9906-042	Red

B9906-058	Black
------------------	--------------



#B9907-xxx 6 Ga. Cotton Braid Primary Wire

10 Feet = \$64.75	25 Feet = \$103.00	50 Feet = \$176.50	100 Feet = \$267.25	500 Feet = \$1256.25
-----------------------------	------------------------------	------------------------------	-------------------------------	--------------------------------

Choose Color From List Below

B9907-042	Red
------------------	------------

B9907-058	Black
------------------	--------------



ARMOR COVERED PRIMARY WIRE

Spiral Wound, Carbon Steel Wrapped, Lacquer Covered Cotton Braid Over PVC;
Insulated To Look Like Old Stock.

Call for Availability

B9908-001 16 GA Single Conductor					B9908-002 16 GA Double Conductor				
10 Feet = \$28.50	25 Feet = \$62.00	50 Feet = \$100.50	100 Feet = \$151.00	500 Feet = \$709.75	10 Feet = \$39.50	25 Feet = \$87.25	50 Feet = \$139.50	100 Feet = \$209.00	500 Feet = \$982.30
B9908-003 16 GA Triple Conductor					B9909-001 14 GA Single Conductor				
10 Feet = \$54.40	25 Feet = \$120.00	50 Feet = \$192.00	100 Feet = \$288.00	500 Feet = \$1353.60	10 Feet = \$40.50	25 Feet = \$90.00	50 Feet = \$144.00	100 Feet = \$221.00	500 Feet = \$1038.70
B9909-002 14 GA Double Conductor					B9910-001 12 GA Single Conductor				
10 Feet = \$44.50	25 Feet = \$97.50	50 Feet = \$167.50	100 Feet = \$250.00	500 Feet = \$1175.00	10 Feet = \$43.60	25 Feet = \$95.50	50 Feet = \$164.00	100 Feet = \$245.00	500 Feet = \$1151.50

PVC PRIMARY WIRE

PVC SAE1128 primary hook up wire

Rated at 60 Volts DC. For Automotive and Tractor use only.



B9911-xxx, 18 GA PVC PRIMARY WIRE

10 Feet = \$11.50	25 Feet = \$14.25	50 Feet = \$16.50	100 Feet = \$21.50	500 Feet = \$76.75
--------------------------	--------------------------	--------------------------	---------------------------	---------------------------

Choose Color From List Below

B9911-001	Natural (White)
B9911-005	White with Black Spiral Tracer
B9911-009	Gray
B9911-080	Gray with Black Spiral Tracer
B9911-011	Yellow
B9911-015	Yellow with Red Spiral Tracer
B9911-017	Yellow with Black Spiral Tracer
B9911-023	Orange

B9911-027	Pink
B9911-028	Purple (Violet)
B9911-029	Blue
B9911-035	Dark Blue
B9911-036	Green
B9911-096	Dark Green
B9911-042	Red
B9911-100	Red with Black Spiral Tracer
B9911-043	Red with White Spiral Tracer

B9911-050	Brown
B9911-101	Brown with White Spiral Tracer
B9911-058	Black
B9911-059	Black with White Spiral Tracer
B9911-103	Black with Yellow Spiral Tracer
B9911-071	Black with Red Spiral Tracer
B9911-085	Tan



B9912-xxx, 16 GA PVC PRIMARY WIRE

10 Feet = \$13.75	25 Feet = \$18.25	50 Feet = \$23.25	100 Feet = \$29.75	500 Feet = \$115.50
--------------------------	--------------------------	--------------------------	---------------------------	----------------------------

Choose Color From List Below

B9912-001	Natural (White)
B9912-075	Natural (White) with Blue Spiral Tracer
B9912-116	Natural (White) with Green Spiral Tracer
B9912-077	Natural (White) with Purple Spiral Tracer
B9912-005	Natural (White) with Black Spiral Tracer
B9912-115	Natural (White) with Red Spiral Tracer
B9912-144	Natural (White) with Brown Spiral Tracer
B9912-009	Gray
B9912-080	Gray with Black Spiral Tracer
B9912-011	Yellow
B9912-013	Yellow with Green Spiral Tracer
B9912-015	Yellow with Red Spiral Tracer
B9912-017	Yellow with Black Spiral Tracer
B9912-023	Orange
B9912-082	Orange with White Spiral Tracer
B9912-083	Orange with Yellow Spiral Tracer

B9912-084	Orange with Black Spiral Tracer
B9912-027	Pink
B9912-087	Pink with White Spiral Tracer
B9912-088	Pink with Green Spiral Tracer
B9912-089	Pink with Black Spiral Tracer
B9912-028	Purple (Violet)
B9912-090	Purple with White Spiral Tracer
B9912-091	Purple with Red Tracer
B9912-029	Blue
B9912-032	Blue with Yellow Spiral Tracer
B9912-094	Blue with Red Spiral Tracer
B9912-156	Blue with Black Spiral Tracer
B9912-035	Dark Blue
B9912-036	Green
B9912-095	Green with Black Spiral Tracer
B9912-037	Green with White Spiral Tracer
B9912-107	Green with Blue Spiral Tracer

B9912-096	Dark Green
B9912-042	Red
B9912-043	Red with White Spiral Tracer
B9912-098	Red with Green Spiral Tracer
B9912-099	Red with Blue Spiral Tracer
B9912-100	Red with Black Spiral Tracer
B9912-050	Brown
B9912-101	Brown with White Spiral Tracer
B9912-146	Brown with Green Spiral Tracer
B9912-058	Black
B9912-059	Black with White Spiral Tracer
B9912-103	Black with Yellow Spiral Tracer
B9912-104	Black with Green Spiral Tracer
B9912-071	Black with Red Spiral Tracer
B9912-085	Tan
B9912-086	Tan with Green Spiral Tracer



B9913-xxx, 14 GA PVC PRIMARY WIRE

10 Feet = \$15.00	25 Feet = \$20.50	50 Feet = \$25.75	100 Feet = \$33.00	500 Feet = \$131.00
--------------------------	--------------------------	--------------------------	---------------------------	----------------------------

Choose Color From List Below

B9913-001	Natural (White)
B9913-116	Natural (White) with Green Spiral Tracer
B9913-115	Natural (White) with Red Spiral Tracer
B9913-005	Natural (White) with Black Spiral Tracer
B9913-145	Natural (White) with Yellow Spiral Tracer
B9913-009	Gray
B9913-011	Yellow
B9913-017	Yellow with Black Spiral Tracer
B9913-023	Orange
B9913-083	Orange with Yellow Spiral Tracer

B9913-084	Orange with Black Spiral Tracer
B9913-027	Pink
B9913-028	Purple (Violet)
B9913-029	Blue
B9913-030	Blue with White Spiral Tracer
B9913-035	Dark Blue
B9913-036	Green
B9913-096	Dark Green
B9913-042	Red
B9913-043	Red with White Spiral Tracers
B9913-099	Red with Blue Spiral Tracer

B9913-100	Red with Black Spiral Tracer
B9913-050	Brown
B9913-101	Brown with White Spiral Tracer
B9913-146	Brown with Green Spiral Tracer
B9913-058	Black
B9913-059	Black with White Spiral Tracer
B9913-104	Black with Green Spiral Tracer
B9913-085	Tan



B9914-xxx, 12 GA PVC PRIMARY WIRE

10 Feet = \$19.00	25 Feet = \$27.25	50 Feet = \$35.50	100 Feet = \$46.25	500 Feet = \$193.25
--------------------------	--------------------------	--------------------------	---------------------------	----------------------------

Choose Color From List Below

B9914-001	Natural (White)
B9914-115	Natural (White) with Red Spiral Tracer
B9914-125	Natural (White) with (1) Red Spiral & (1) Black Spiral Tracer
B9914-005	Natural (White) with Black Spiral Tracer
B9914-009	Gray
B9914-011	Yellow
B9914-017	Yellow with Black Spiral Tracer

B9914-023	Orange
B9914-027	Pink
B9914-028	Purple (Violet)
B9914-029	Blue
B9914-035	Dark Blue
B9914-036	Green
B9914-096	Dark Green
B9914-042	Red

B9914-043	Red with White Spiral Tracer
B9914-100	Red with Black Spiral Tracer
B9914-050	Brown
B9914-147	Brown with Red Spiral Tracer
B9914-146	Brown with Green Spiral Tracer
B9914-058	Black



B9915-xxx, 10 GA PVC PRIMARY WIRE

10 Feet = \$25.75	25 Feet = \$39.75	50 Feet = \$51.25	100 Feet = \$69.50	500 Feet = \$301.75
-------------------	-------------------	-------------------	--------------------	---------------------

Choose Color From List Below

B9915-001	Natural (White)
B9915-115	Natural (White) With Red Spiral Tracer
B9915-009	Gray

B9915-011	Yellow
B9915-023	Orange
B9915-029	Blue
B9915-036	Green

B9915-042	Red
B9915-050	Brown
B9915-058	Black



B9916-xxx, 8 GA PVC PRIMARY WIRE

10 Feet = \$38.50	25 Feet = \$60.00	50 Feet = \$81.00	100 Feet = \$110.75	500 Feet = \$495.75
-------------------	-------------------	-------------------	---------------------	---------------------

Choose Color From List Below

B9916-001	Natural (White)
B9916-036	Green

B9916-042	Red
B9916-050	Brown

B9916-058	Black
------------------	-------

AUTOMOTIVE DUPLEX



Available in Multiple Colors.

- Two-Conductor PVC Insulated Primary Wire
- Comes Covered in Gray PVC to Protect Against Weathering, Abrasion, & Chemicals
- Heavy Duty Cable Used with Various Applications on Motorized Vehicles (Particularly Service Vehicles)
- Rated for 60 Volt or Less Systems & Meets SAEJ1128 Standards

#B9933-xxx, 16 Gauge Automotive Duplex

10 Feet = \$23.25	25 Feet = \$32.25	50 Feet = \$41.25	100 Feet = \$53.00	500 Feet = \$240.75
-------------------	-------------------	-------------------	--------------------	---------------------

Choose Color

B9933-001	Red & Black
B9933-002	Green & Yellow
B9933-003	Black & White

#B9940-xxx, 14 Gauge Automotive Duplex

10 Feet = \$26.50	25 Feet = \$40.50	50 Feet = \$57.75	100 Feet = \$86.00	500 Feet = \$330.00
-------------------	-------------------	-------------------	--------------------	---------------------

Choose Color

B9940-001	Red & Black
B9940-003	Black & White

COPPER SPARK PLUG WIRE

COTTON BRAID SPARK PLUG WIRE

Lacquer covered cotton braid, over PVC copper wire;
Insulated to look like old stock.

#B9917-xxx, 7mm Cotton Braid Spark Plug Wire



10 Feet = \$21.00	50 Feet = \$87.00
15 Feet = \$31.50	100 Feet = \$152.25
25 Feet = \$48.50	500 Feet = \$715.25

B9917-009	Gray
B9917-162	Gray with (2) Red Parallel Tracers
B9917-050	Brown
B9917-105	Satin Black (without Tracers)
B9917-106	Glossy Black (without Tracers)
B9917-059	Black with (1) White Tracer
B9917-107	Black with Yellow Cross Tracers
B9917-137	Black with (2) Yellow Cross Tracers (Authentic Ford Color)
B9917-067	Black with Blue Cross Tracers
B9917-135	Black with (2) Blue Cross Tracers (Authentic Ford Color)
B9917-070	Black with Green Cross Tracers
B9917-136	Black with (2) Green Cross Tracers (Authentic Ford Color)
B9917-073	Black with Red Cross Tracers
B9917-134	Black with (2) Red Cross Tracers (Authentic Ford Color)
B9917-108	Black with (2) Orange Cross Tracers
B9917-109	Red with Black & Yellow Cross Tracers
B9917-123	Red with Black Cross Tracers
B9917-110	Orange with Black Tracers (Original Pattern For 1931 & Earlier GM)
B9917-026	Orange (Oak) with Red & Black Cross Tracers
B9917-111	Yellow (Lemon Yellow) with Red & Black Cross Tracers
B9917-112	Yellow (Lemon Yellow) with (1) Black Tracer
B9917-113	Green with Yellow Parallel Tracers

#B9919-xxx, 9mm Cotton Braid Spark Plug Wire



10 Feet = \$28.25	50 Feet = \$110.00
15 Feet = \$42.00	100 Feet = \$185.25
25 Feet = \$60.50	500 Feet = \$820.00

B9919-105	Satin Black (without Tracers)
B9919-110	Orange (Oak) with (1) Black Tracer
B9919-026	Orange (Oak) with Black & Red Cross Tracers

PVC SPARK PLUG WIRE

#B9920-xxx, 7mm PVC

Spark Plug Wire Insulated with a copper core



#B9920-058, Black PVC

10 Feet = \$10.00	50 Feet = \$33.00
15 Feet = \$14.75	100 Feet = \$51.75
25 Feet = \$20.25	500 Feet = \$243.25

#B9920-002, Clear PVC

10 Feet = \$10.50	50 Feet = \$45.50
15 Feet = \$15.75	100 Feet = \$79.50
25 Feet = \$24.75	500 Feet = \$373.75

#B9920-003, Red Translucent PVC

10 Feet = \$10.50	50 Feet = \$45.50
15 Feet = \$15.75	100 Feet = \$79.50
25 Feet = \$24.75	500 Feet = \$373.75

#B9939-058, 9mm Black PVC

Spark Plug Wire

Insulated with a copper core



10 Feet = \$13.00	50 Feet = \$57.50
15 Feet = \$19.75	100 Feet = \$99.25
25 Feet = \$31.25	500 Feet = \$467.25

#B9922-058, 7mm Black Packard 440 (AC Delco) Spark Plug Wire



Original Type OEM General Motors Product. Made With Tinned Copper Core & EPDM, Silicone Insulation

10 Feet = \$123.00	50 Feet = \$395.75
15 Feet = \$182.75	100 Feet = \$709.75
25 Feet = \$262.50	500 Feet = \$3335.75

#B9921-xxx, 7mm EPDM

Spark Plug Wire



Silicone Insulated With Tinned Copper Core- An Economical Replacement For Packard 440 Spark Plug Wire

10 Feet = \$10.50	50 Feet = \$45.50
15 Feet = \$15.75	100 Feet = \$79.50
25 Feet = \$24.75	500 Feet = \$373.75

B9921-058	Black	B9921-029	Blue
B9921-009	Gray	B9921-042	Red
B9921-011	Yellow		

SUPPRESSION CORE SPARK PLUG WIRE

#B9938-xxx, 7.8mm Cotton Braid Suppression Spark Plug Wire

Lacquer covered cotton braid, over EPDM Silicone, Insulated with Spiral Wound Suppression Core to look like old stock.



10 Feet = \$34.50	50 Feet = \$142.75
15 Feet = \$51.75	100 Feet = \$250.75
25 Feet = \$80.00	500 Feet = \$1178.75

B9938-050	Brown
B9938-009	Gray
B9938-162	Gray with (2) Red Parallel Tracers
B9938-105	Satin Black (without Tracers)
B9938-106	Glossy Black (without Tracers)
B9938-059	Black with (1) White Tracer
B9938-107	Black with Yellow Cross Tracers
B9938-137	Black with (2) Yellow Cross Tracers
B9938-067	Black with Blue Cross Tracers
B9938-135	Black with (2) Blue Cross Tracers
B9938-070	Black with Green Cross Tracers
B9938-136	Black with (2) Green Cross Tracers
B9938-073	Black with Red Cross Tracers
B9938-134	Black with (2) Red Cross Tracers
B9938-108	Black with (2) Orange Cross Tracers
B9938-109	Red with Black & Yellow Cross Tracers
B9938-110	Orange with Black Tracers (Original Pattern For 1931 & Earlier GM)
B9938-026	Orange (Oak) with Red & Black Cross Tracers

Table continues at top of next column.

B9938-111	Yellow (Lemon Yellow) with Red & Black Cross Tracers
B9938-112	Yellow (Lemon Yellow) with (1) Black Tracer
B9938-113	Green with Yellow Parallel Tracers

7mm EPDM Spiral Wound Suppression Ignition Cable

#B9946-058, Low Ohm (1100 Ohms)

#B9952-xxx, Ultra Low Ohm (500 Ohms)



Graphite Core with a Spiral Wound Stainless Steel Spring for Protection. Economical Replacement for Packard Suppression Ignition Cable.

10 Feet = \$16.00	50 Feet = \$44.50
15 Feet = \$24.00	100 Feet = \$79.50
25 Feet = \$29.50	500 Feet = \$373.75

B9952-058	Black	B9952-029	Blue
B9952-009	Gray	B9952-042	Red
B9952-011	Yellow		

#B9936-xxx, 7mm Packard Spiral Wound Suppression Ignition Cable



Black EPDM Silicone Insulated with Spiral Wound Suppression Core. Original Type

10 Feet = \$23.00	50 Feet = \$63.25
15 Feet = \$34.25	100 Feet = \$112.75
25 Feet = \$41.75	500 Feet = \$530.25

BATTERY CABLE



Cotton Braid Battery Cable

Lacquer covered Cotton Braid over PVC; Insulated to look like old stock.

#B9937-xxx, #6 Gauge

2 Feet = \$11.50	5 Feet = \$28.75
10 Feet = \$57.50	15 Feet = \$86.25

25 Feet = \$143.75

B9937-042 = Red	B9937-058 = Black
-----------------	-------------------

B9923-xxx, #4 Gauge

2 Feet = \$13.50	5 Feet = \$33.75	
10 Feet = \$67.50	15 Feet = \$101.25	25 Feet = \$168.75
B9923-042 = Red		B9923-058 = Black

B9924-058, #2 Gauge Black

2 Feet = \$17.50	5 Feet = \$43.75	
10 Feet = \$87.50	15 Feet = \$131.25	25 Feet = \$218.75

B9925-058, #1 Gauge Black

2 Feet = \$19.00	5 Feet = \$47.50	
10 Feet = \$95.00	15 Feet = \$142.50	25 Feet = \$237.50

B9926-058, #1/0 Gauge Black

2 Feet = \$22.50	5 Feet = \$56.25	
10 Feet = \$112.50	15 Feet = \$168.75	25 Feet = \$281.25

B9927-058, #2/0 Gauge Black

2 Feet = \$26.00	5 Feet = \$65.00	
10 Feet = \$130.00	15 Feet = \$195.00	25 Feet = \$325.00

PVC Battery Cable



#B9954-xxx, #6 Gauge

2 Feet = \$7.50	5 Feet = \$18.75
10 Feet = \$37.50	15 Feet = \$56.25
25 Feet = \$93.75	

B9954-042 = Red	B9954-058 = Black
-----------------	-------------------

#B9928-xxx, #4 Gauge

2 Feet = \$7.50	5 Feet = \$18.75
10 Feet = \$37.50	15 Feet = \$56.25
25 Feet = \$93.75	

B9928-042 = Red	B9928-058 = Black
-----------------	-------------------

#B9929-xxx, #2 Gauge

2 Feet = \$11.50	5 Feet = \$28.75	
10 Feet = \$57.50	15 Feet = \$86.25	25 Feet = \$143.75

B9929-042 = Red	B9929-058 = Black
-----------------	-------------------

#B9930-xxx, #1 Gauge

2 Feet = \$13.00	5 Feet = \$32.50	
10 Feet = \$65.00	15 Feet = \$97.50	25 Feet = \$162.50

B9930-042 = Red	B9930-058 = Black
-----------------	-------------------

#B9931-xxx, #1/0 Gauge

2 Feet = \$16.00	5 Feet = \$40.00	
10 Feet = \$80.00	15 Feet = \$120.00	25 Feet = \$200.00

B9931-042 = Red	B9931-058 = Black
-----------------	-------------------

#B9932-xxx, #2/0 Gauge

2 Feet = \$19.50	5 Feet = \$48.75	
10 Feet = \$97.50	15 Feet = \$146.25	25 Feet = \$243.75

B9932-042 = Red	B9932-058 = Black
-----------------	-------------------

EPR Welding Cable

Rated: Up to 600 Volts / -50°C (-58°F) to 105°C (221°F)

B9955-xxx	#4 Gauge	\$3.25/FT
B9955-042 = Red		B9955-058 = Black

B9941-xxx	#2 Gauge	\$4.25/FT
B9941-042 = Red		B9941-058 = Black

B9942-xxx	#1 Gauge	\$4.50/FT
B9942-042 = Red		B9942-058 = Black

B9943-xxx	#1/0 Gauge	\$5.75/FT
B9943-042 = Red		B9943-058 = Black

B9944-xxx	#2/0 Gauge	\$6.75/FT
B9944-042 = Red		B9944-058 = Black

B9945-xxx	#3/0 Gauge	\$7.25/FT
B9945-042 = Red		B9945-058 = Black

Note: We Can Custom Make Battery Cables From The Materials Listed Above! (\$3.00 Per End To Assemble - All Connections Are Soldered & Heat Sealed, Not Crimped)

BATTERY GROUND STRAPS (HEAVY DUTY)



#B2000-xxx, #2 GA Wire Flat Braided, Heavy Duty Battery Ground Strap

Good for 6-Volt Systems, Measured from Center Hole to Center Hole, Made in the USA

B2000-001	5 1/2"	\$9.00
B2000-002	7"	\$9.50
B2000-004	9"	\$10.50
B2000-005	11"	\$12.50
B2000-006	14"	\$13.50
B2000-007	16 1/2"	\$14.50
B2000-008	19"	\$15.50
B2000-009	24"	\$17.00
B2000-010	27"	\$21.75

BONDING STRAPS



#B9006-xxx, #4 GA Wire Flat Braided Bonding Strap Measured from Center Hole to Center Hole

B9006-001	5"	\$7.00
B9006-002	6.5"	\$7.50
B9006-003	8"	\$8.00
B9006-004	12 1/2"	\$9.50
B9006-005	18"	\$12.50 *Call for availability

NON-METALLIC WIRE LOOM



#B9007-xxx, Asphaltic- Coated Conduit

Old Fashioned Wire Loom

B9007-001	5/32" Inside Diameter
5 Feet = \$4.00	10 Feet = \$6.75
15 Feet = \$10.00	25 Feet = \$15.00
100 Feet = \$47.50	

B9007-002	3/16" Inside Diameter
5 Feet = \$4.00	10 Feet = \$6.75
15 Feet = \$10.00	25 Feet = \$15.00
100 Feet = \$47.50	

B9007-003	1/4" Inside Diameter
5 Feet = \$4.75	10 Feet = \$7.75
15 Feet = \$11.75	25 Feet = \$17.50
100 Feet = \$55.75	

B9007-004	5/16" Inside Diameter
5 Feet = \$5.50	10 Feet = \$9.00
15 Feet = \$13.25	25 Feet = \$20.00
100 Feet = \$63.75	

B9007-005	3/8" Inside Diameter
5 Feet = \$6.25	10 Feet = \$10.00
15 Feet = \$15.00	25 Feet = \$22.50
100 Feet = \$71.50	

B9007-006	7/16" Inside Diameter
5 Feet = \$6.75	10 Feet = \$11.00
15 Feet = \$16.50	25 Feet = \$24.75
100 Feet = \$79.25	

B9007-007	1/2" Inside Diameter
5 Feet = 7.25	10 Feet = \$12.25
15 Feet = \$18.25	25 Feet = \$27.25
100 Feet = \$87.25	

B9007-008	9/16" Inside Diameter
5 Feet = \$8.00	10 Feet = \$13.25
15 Feet = \$20.00	25 Feet = \$29.75
100 Feet = \$95.25	

B9007-009	5/8" Inside Diameter
5 Feet = \$10.00	10 Feet = \$14.00 15.50
15 Feet = \$24.75	25 Feet = \$37.25
100 Feet = \$119.00	

B9007-010	3/4" Inside Diameter
5 Feet = \$11.75	10 Feet = \$19.25
15 Feet = \$29.00	25 Feet = \$43.50
100 Feet = \$139.25	

B9007-011	1" Inside Diameter
5 Feet = \$12.00 13.25	10 Feet = \$20.00 22.00
15 Feet = \$30.00 33.00	25 Feet = \$45.00 49.50
100 Feet = \$158.50	



#B9008-xxx, Expandable Plastic Conduit

Modern Type Wire Loom

B9008-001	1/8" working range 3/32" to 1/8"	\$0.40/FT
B9008-002	1/4" working range 1/8" to 3/8"	\$0.50/FT
B9008-003	1/2" working range 1/4" to 3/4"	\$0.75/FT
B9008-004	3/4" working range 1/2" to 1 1/4"	\$1.00/FT



#B9009-xxx, Split Plastic Conduit

Modern Type Wire Loom

B9009-001	1/4" Inside Diameter	\$0.50/FT
B9009-002	3/8" Inside Diameter	\$0.60/FT
B9009-003	1/2" Inside Diameter	\$0.75/FT
B9009-004	5/8" Inside Diameter	\$0.90/FT
B9009-005	3/4" Inside Diameter	\$1.00/FT

METALLIC WIRE LOOM



#B9010-xxx, Galvanized Steel Conduit

Old Fashioned Armored Loom, Like the Original Type

B9010-001	3/16" Inside Diameter
5 Feet = \$9.00	10 Feet = \$15.00
15 Feet = \$22.50	25 Feet = \$33.75

B9010-002	1/4" Inside Diameter
5 Feet = \$9.00	10 Feet = \$15.00
15 Feet = \$22.50	25 Feet = \$33.75

B9010-003	5/16" Inside Diameter
5 Feet = \$10.50	10 Feet = \$17.50
15 Feet = \$26.25	25 Feet = \$39.50

B9010-004	3/8" Inside Diameter
5 Feet = \$12.00	10 Feet = \$20.00
15 Feet = \$30.00	25 Feet = \$45.00

B9010-005	1/2" Inside Diameter
5 Feet = \$13.50	10 Feet = \$22.50
15 Feet = \$33.75	25 Feet = \$50.50

B9010-006	5/8" Inside Diameter
5 Feet = \$15.00	10 Feet = \$25.00
15 Feet = \$37.50	25 Feet = \$56.25

B9010-007	1" Inside Diameter
5 Feet = \$21.00	10 Feet = \$35.00
15 Feet = \$52.50	25 Feet = \$78.75

#B9011-xxx, 304 Stainless Steel Conduit

Old Fashioned Armored Loom Like the Original Type

B9011-008	5/32" Inside Diameter	
5 Feet = \$16.50	10 Feet = \$27.75	
15 Feet = \$41.25	25 Feet = \$62.00	
B9011-001	3/16" Inside Diameter	
5 Feet = \$18.00	10 Feet = \$30.00	
15 Feet = \$45.00	25 Feet = \$67.50	
B9011-002	1/4" Inside Diameter	
5 Feet = \$19.50	10 Feet = \$32.50	
15 Feet = \$48.75	25 Feet = \$73.00	
B9011-003	5/16" Inside Diameter	
5 Feet = \$21.00	10 Feet = \$35.00	
15 Feet = \$52.50	25 Feet = \$78.75	
B9011-004	3/8" Inside Diameter	
5 Feet = \$22.50	10 Feet = \$37.50	
15 Feet = \$56.25	25 Feet = \$84.50	
B9011-005	1/2" Inside Diameter	
5 Feet = \$25.50	10 Feet = \$42.50	
15 Feet = \$63.75	25 Feet = \$95.50	
B9011-006	5/8" Inside Diameter	
5 Feet = \$31.50	10 Feet = \$52.50	
15 Feet = \$78.75	25 Feet = \$118.00	



#B9020-xxx, 304 Stainless Steel Conduit Ferrule

Fits Galvanized or Stainless Steel Conduit Above

B9020-001	Fits 5/16" Inside Diameter	\$8.50
------------------	----------------------------	---------------

GAUGES

Ammeters, Universal

B9025-002	Ammeter 20-0-20	\$19.99
	No logo included. Fits in 2" Diameter Hole 1.850" From Post to Bottom of Bezel	
B9025-005	Ammeter 30-0-30	\$19.99
	No logo included. Fits in a 2" Diameter Hole 1.740" From Top of Post to Bottom of Bezel	

B9025-008	Ammeter 60-0-60	\$19.99
	Has threaded terminals and is dash mounted Used with 12-Volt Alternator Systems Fits in 2" Diameter Hole Measures 1.765" from Top of Post to Bottom of Bezel	

For Applications & Gauges with Manufacturer Logos, check the Machinery/Vehicle sections of the catalog



Oil Pressure Gauges, Universal

B9025-004	Universal Oil Pressure Gauge (0-50 PSI)	\$21.99
	Has 1/8" NPT male threads, studs, & a bracket. No logo included. Dash mounted, it requires a 2" diameter hole.	
B9025-001	Universal Oil Pressure Gauge (0-80 PSI)	\$24.99
	Has 1/8" NPT male threads, studs, & a bracket. No logo included. Dash mounted, it requires a 2" diameter hole.	

Oil Pressure Gauge, Line Kit

B9026-001	Oil Pressure Gauge Line Kit	\$29.99
	6 FT copper 1/8" line Kit includes: (x2) 5/16 - 24 UNF nuts, (x2) compression sleeves, (x1) 1/8 - 27 NPTF female to 5/16" - 24 UNF male adapter Note: Depending on application, customer may be required to purchase other fittings.	

Water Temperature Gauges, Universal

B9025-006	Water Temperature Gauge	\$34.99
	Includes an Aluminum Sealing Washer to Seal Probe Has White, Green, Red Zones 1/2" NPT Pipe Bushing and Probe Length of 1.279" 60" Capillary Lead	
B9025-007	Universal Water Temperature Gauge	\$34.99
	Measures from 100 degrees to 220 degrees Dash-mounted (parts included) 72" long heavy duty capillary tube included (check length before ordering) Fits into a 2" diameter hole, 90 degree pointer sweep, 5/8" - 18 UF thread with 1/2" NPT pipe bushing Probe length to fitting measures 1.515", 0.383" probe diameter	

SWITCHES & KNOBS

Knobs

B5001-001	Black Bakelite Knob with "LIGHTS" Imprinted			
	Qty 1-9	\$4.20	Qty 100-499	\$2.73
	Qty 10-25	\$3.36	Qty. 500-999	\$2.42
	Qty 26-99	\$3.05	Qty. 1000+	\$2.10
#10/32 Threads. Interchangeable knob with all our available Push/Pull Switch Products.				
B5001-002	Plain Black Bakelite Knob	\$5.99		
	#10/32 Threads Interchangeable knob with all our available Push/Pull Switch Products			
B5001-003	Chrome Plated Solid Brass Knob	\$3.50		
	#10/32 Threads Interchangeable knob with all our available Push/Pull Switch Products			

B5001-004	Push/Pull Knob	\$7.99
	#10/32 Threads Interchangeable knob with #B5002-008, B5002-009	

B5001-005	Push/Pull Knob	\$6.75
	Black Knob Used With #B9016-018, #B9016-021, #B9016-032, #B9016-033. Replaces - IHC/Farmall: #359773R91 Fits - IHC/Farmall: [A, A1, AV, B, BN, C, Cub, H, HV, M, MD, MTA, Super A, Super C, Super H, Super HV, Super M, Super WD9, WDR9, WR9S, 100, 130, 140, 200, 230, 240, 300, 330, 340, 400, 450, 600, 650 (OEM STYLE)], 350 (Rowcrop, OEM STYLE), [Wheatland: 400, 450 (OEM STYLE)], Cub LoBoy: Cub Loboy (OEM STYLE) Cockshutt (Co-Op): 20, 30, 35, 40, 50, 560, 570, Co-Op with Continental F124: E2, Co-Op with Buda Over Head Valve Engine: E3, E4, E5	

Push/Pull Switches

Universal Battery Ignition/Lights

B5002-001	2 Position Push/Pull Switch	\$7.75
	Universal, 2-Position Push/Pull 2 Screw Terminals Mounting Stem 3/8"-32 Thread Knob #10/32 Thread	
B5002-002	2-Position Push/Pull Switch	\$11.75
	Universal, 2-Position Push/Pull 2 Screw Terminals Mounting Stem 1/2"-20 Thread Knob #10/32 Thread	
B5002-003	2-Position Push/Pull Switch with Fuse Holder	\$10.75
	Knob: #10-32 Threads Mounting Threads: 1/2"-20 Treads OFF/ON 6-36 Volt 20 Amp Fuse Installed Replaces Cole Hersee #5067	

B5002-013	Light Switch	\$13.75
	Substitute for #B5002-002 above Includes Fuse	

B5002-014	Knurled Knob Light Switch	\$15.75
	Substitute for #B5002-002 above Includes Fuse	

Magneto Ignition Switches

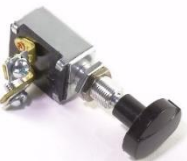
B5002-004	Heavy Duty Push/Pull Magneto Switch	\$8.25
	ON/OFF, 2-Position Push/Pull Magneto Switch 2 Screw Terminals Mounting Stem 3/8"-32 Thread Knob #10/32 Thread Allis Chalmers -Replaces: #213140, 70213140 White -Replaces: #BAS-884	

Light Switches

B5002-005	3-Position Push/ Pull Switch	\$29.75
	Low Charge/High Charge/Lights 3-Position Switch, 3 Screw Type Mounting Stem .8" Thread Knob #10/32 Thread Premium Quality Made by an OEM Manufacturer Replaces: Delco - 479G, 1994011 Allis Chalmers - #208197, 70208197 Avery - #AT61 Case - #VTA463 Cockshutt - #TO7524 John Deere - #AL2857T, AF708R, AF687R, AB2687R Massey Harris - #15199A, 837078M91, 850449M1, 851674M1 Minneapolis Moline - #UT2374C, UT2374 White - #H7345A	

B5002-006	3-Position Push/Pull Switch with Circuit Breaker	\$34.75
	OFF/Park&Tail/Head&Tail 3-Position Push/Pull Switch 3 Screw Terminals Includes 30 Amp Circuit Breaker Knob #10/32 Thread Mounting Stem 7/16"-28 Thread	

Key Switches

Battery Ignition

B5003-001	2-Position Battery Key Switch	\$14.75
	Universal OFF/ON 2-Position Key Switch 2 Screw Terminals Mounting Stem 3/4"-20 Thread	

B5003-002	4-Position Battery Key Switch	\$14.75
	ACC/ OFF/ IGN(ACC)/ IGN(Start) Universal 4-Position Key Switch 4 Screw Terminals Mounting Stem 3/4"-20 Thread	

B5003-003	3-Position Battery Key Switch	\$29.75
	*Call for Availability* OFF/IGN/IGN(Start) 3 Position Key Switch 3 Screw Terminals Mounting Stem 3/4"-20 Thread 10 Amp	

Battery Ignition & Lights

B5003-004	4-Position Battery Key Switch	\$22.99
	Includes 2 keys, OFF/IGN/IGN Lights/Lights (4 Position) Key Switch 3 Screw Terminals Mounting Stem 5/8"-32 Thread Replaces: Massey Ferguson - #180681M93 Massey Harris - #851846M1 Fits: Massey Ferguson - TO-20, TO-30, TO-35, 65, 85, 88, 202, 204, 302, 304, 35, 40, 50 (Gas up to SN: 528971) Massey Harris - Pacer (16), Pony (1953 and up), 50	

B5003-023	Ignition Key	\$5.99
	Key for Part Above, #B5003-004. Original Style Plastic Knob. Verify style before ordering, since more than one style could be used. Massey Ferguson Replaces: #180292M1, 192427M1	

For Applications, check the Machinery/Vehicle sections of the catalog

B5003-005	4-Position Ignition Key Switch	\$39.99
	2 battery terminals, 5 Spade Terminals, OEM Style Delco Remy 995" Diameter Threaded End. Includes 2 Keys & Jam Nut Replaces – Allis Chalmers: #235785, 70235785, 229201, 234356, 233320 Case: #D75657, L17820, A11373 International: #300557R91, 1116629, 361998R93 Minneapolis Moline: #20-7101027 Oliver: #K7354B, 100423ASA, 105232AS White: #20-7101027, 721146A, 611064AS	

B5003-006	Ignition Key	\$4.99
	Key for Part Above, #B5003-005. Brass Finish Fits Listed Models Using Delco Switch Allis Chalmers - Replaces: #231713, 70231713, 72162639 Case - Replaces: #A20346 Cockshutt - Replaces: #MAO836 White - Replaces: #105678A, 72162639, 611105A	

Magneto Ignition

B5003-010	3-Position Magneto Key Switch	\$34.25
	Universal OFF/ Run/ Accessories/ Start (3 Position) Key Switch (For Magneto Ignition) (4 Screw Terminals) Mounting Stem 3/4"-20 Thread	

Momentary Switches

B5004-001	Momentary Push Switch	\$14.00
	Manual Push Button Solenoid Switch (2 Screw Terminals) Mounting Stem 5/8"-32 Thread	

B5004-002	Momentary Push Switch	\$31.75
	Manual Pull Button Solenoid Switch 2 Screw Terminals Mounting Stem 5/8"-32 Thread John Deere – Replaces: #AB1837	

B5004-003	Momentary Push Switch	\$15.75
	Manual Push Button Solenoid Switch with Rubber Protected Cap 2 Screw Terminals Mounting Stem 5/8"-32 Thread	

Dimmer & Stop Lamp Switches

B5005-001	Headlamp Dimmer Switch	\$17.25
	3 Screw Terminals Mounting Stem 1/4"-20 Thread	

STARTER SWITCHES (Mechanical)

B5006-001	Starter Switch (Long Shaft)	\$12.75
	6 or 12 Volt Panel Mounted Manual Push Start Switch Replaces: Case - #04981-AB, VT3588, Caterpillar - #2Y-6417, 7929, Chrysler - #PL2302, Delco - #192119, D900, 450C Ford - #9N11450A International Harvester (Farmall) - #131332-C2, 313331-C1, 313332-C1 John Deere - #AE13467, AE13467E, AE13547, AE13547E, Massey Ferguson - #1816-79-M1, RO1327, Massey Harris - #1816-79-M1, RO1327 Prestolite - #15-121, 15-122, 15-409, 15-45, 15-47, 15-50, 15-51, SW-2916, SW-4001, SW-4002, SW-4005, SW-4010, SW-4013, SW-4015, SW-4017, SW-4101, SWX-47	

****For Applications, check the Machinery/Vehicle section of the catalog****

SOLENOIDS

B5006-002	Starter Switch	\$15.75
	Replaces: Autolite - #SW-4012 (15-49) Delco - #1996478 Massey Ferguson - #829960M31	
B5006-003	Saddle Mount Lever Switch	\$11.75
	Lever or Rod operated, 6 or 12 Volt, Starter Mounted Manual Push Button Starter Switch Has Bracket for Rocker Lever Replaces: Allis Chalmers - #226128 Delco - #1872403, 1872405, 1882323, 1918405, 1919576, 1919600, 1925781, 1918405, 1919578, 1919600, 1923480, 1925781, 1932131, 1940047, D903, D904, D905, D908, D909, IHC/Farmall - #593292C1, 70249D, John Deere - #1882323, AT21265 Oliver - #1E7392, 1918405, 1918409	
B5006-004	Starter Switch	\$11.75
	6 or 12 Volt Starter Mounted Manual Push Button Starter Switch	
B5006-005	12 Volt Manual Push Starter Switch	\$17.50
	12 Volt Starter Mounted Manual Push Switch with Side Terminal for Bypass Start Fits starters: #1107188, 1107634, 1113004, 1113005, 1113041, 1113304 Replaces: John Deere - #1934779, AR11115R, 1928209, AR11006R Delco - #D906, 1930496, 1930505	

****For Applications, check Machinery/Vehicle section of catalog****

B5007-001	6 Volt Solenoid	\$17.50
	3 Terminal Solenoid with Curved Bracket.	
B5007-002	12 Volt Solenoid	\$17.50
	12 Volt, 3 Terminal Solenoid With A Curved Mounting Bracket Replaces: Autolite - SAE-4005, 15-60, SAW-4201	
B5007-010	12 Volt Solenoid (Manual Push Button)	\$20.00
	12 Volt, 3 Terminal Solenoid With A Curved Mounting Bracket & Manual Push Button. Replaces: Autolite - SAE-4005, 15-60, SAW-4201	
B5007-003	12 Volt Solenoid	\$17.50
	3 Terminal with Flat Bracket Replaces: Autolite/ Prestolite - #15-134, 15-136, 15-189, 15-250, SAE4001, SAE4005, SAE4005T, SAE4006, SAT4005, SAS4203, SAS4203M, SAS4205, SAW4204, SAW4207 Ford - SWX118 IHC/Farmall - #121613C1 John Deere - #AM53945, AR54484	
B5007-004	12 Volt Solenoid	\$23.75
	Has a Curved Bracket & 4 Terminals (Used with 30 & 35 MT Delco Starters) Replaces: Delco - #1119890, 1119912, 1119885, 1119877, 1119935, 1119882, 1119906, D953, D985, 1119833, 1119883, 1115537, 1119978, 1115582, 1119778, 1115508, 1115529, 1115540, 1115501 IHC/Farmall - #65479C2, 585618C91	

B5007-005	6 Volt Isolated Base Solenoid	\$17.75
	Has a Flat Bracket & 3 Terminal Post. Works with 6 Volt Systems. With Push Button. Isolated base/ isolated ground. Replaces: Autolite/ Prestolite - #SW1, SW219 Delco - #DR1494, U925, U928 Ford - #NCA11450A, 21A-11450	
B5007-006	6 Volt Continuous Duty Solenoid	\$21.75
	Has a Flat Mounting Bracket, 4 Terminal Post, & Steel Housing. Works with 6 Volt Systems. Replaces: Prestolite - #15-144, 15-5, SAS4601	
B5007-007	6 Volt Internal Ground Solenoid	\$17.50
	Has a Flat Bracket & 3 Terminal Post. Works with 6 Volt Systems. Replaces: Autolite - #SST-4006 (15-29), SST-4007 (15-30)	
B5007-008	12 Volt Solenoid with Bakelite Case	\$17.75
	Has a Flat Mounting Bracket & is 12 Volts. It has 4 Terminals with a Bakelite Housing. It has 5/16-24 Thread for Battery and Motor Post and a 10-32 Post for the Terminal Switch. Replaces: Delco - #1972255, 1974921 Prestolite - #15-394, 15-406, 15-411, 15-444, 15-486, SAS-4217Y, SAZ-4201BBY, SAZ-4201BW, SAZ-4201CPY, SAZ-4201EW Ford Car/Truck - #B6AZ-11450-A, DZAF-11450-AA, SW-3	
B5007-009	6 Volt Solenoid with Bakelite Case	\$17.75
	Has a Flat Mounting Bracket & is 6 Volts. It has 4 Terminals with a Bakelite Housing & Isolated Base/ Isolated Ground. Replaces: Delco - #1114542, 1111451, 1111460, 1111469, 1972147, F902 Prestolite - #15-159, 15-188, SAW-4606, SAW-4606T, SAW-4608 Ford - #311007, SW217	

B5007-011	12 Volt Continuous Duty Solenoid	\$17.50
	Continuous Duty Rated at 12 Volts with a Flat Mounting Bracket. It has 4 Terminal Post with a Metal Housing. Designed for Low Current Draw. Replaces: Autolite/ Prestolite - #15-88, 15-133, 15-236, 15-311, 15-316, SAS-4201, SAS-4202, SAS-5201A, SAS5203, SAS-5203A, SWX-88 Delco - #1114208, 1114218, 1114283, 1114223, 1114534, 1114547	
B5007-012	6 Volt Ford 8N Solenoid	\$17.50
	6 Volt Rated Solenoid with Special Curved Base Mounting Bracket & 3 Terminal Post. Replaces: Delco - #U938 Ford - #8N-11450, SW218, SW355	
B5007-014	12 Volt Solenoid for Lucas M50 Starters	\$33.50
	12 Volt Rated Solenoid with 4 Terminals and Mounted to Lucas M50 Direct Drive Starters. Replaces: Lucas - #77004, 77089, TOB175 Massey Ferguson - #1052442M91, 3473296M91	
B5007-015	12 Volt Solenoid for Lucas M50 Starters	\$34.25
	12 Volt Rated Solenoid with 4 Terminals and Mounted to Lucas M50 Direct Drive Starters. Replaces: Lucas - #60933087, 76906, 76937, 77123, 77123A, TOB118, TPB100 Allis Chalmers - #256898, 256948, 70273901 Massey Ferguson - #1447-586-M91, 8972-69-M1	
B5007-016	12 Volt Bosch Solenoid	\$31.75
	12 Volt Rated Solenoid for Bosh Starters with 2 Terminals. Has a Crimped Cap & 3 Hole Mount. Replaces: Bosch - #0331401011, 0331401013, 0331401026, 0331401035, 0331401038, 0331401040, 0331402001, 0331402016, 0331402019, 0331402023, 0331402030, 0331402035, 0331402039, 0331402087, 0331402205, 0331402501, 0331402504, 0331402519, 0331402535, 0331402539, 2339402150 John Deere - #AL41524, AL25266, AL55046	

B5007-017	12 Volt Lucas Solenoid	\$29.75
	<p>12 Volt Rated Solenoid with 4 Terminals for Lucas M45G, M127, M418G Starters. 2 Hole Mount Stud & Removable Plunger. Replaces: Lucas - #76755, 76763, 76786, 76796, 76800, 76803, 76804, 76815, 76816, 76820, 76821, 76823, 76824, 76826, 76827, 76837, 76850, 76852, 76855, 76871, 76885, 76891, 76892, 76894, 76895, 76896, 76897, 76899, 76902, 76908, 76940, 76961, 76982, 76983, 77034, 77035, 77058, 77157, 77160, TOB109, TOB113, TOB121, TOB128, TOB134, TOB162, TPB107 Case - #K963825 Massey Ferguson - #3475771M91</p>	

B5007-018	Lucas M50 12-Volt Starter Solenoid	\$40.75
	<p>12 Volt Rated Solenoid for Lucas M50 Direct Drive Starters. Has 4 Terminals. Replaces: Lucas - #27228A, 76740, 76753, 76756, 76781, 76825, 76833, 76834, 76835, 76836, 76854, 76862, 76864, 76865, 76869, 76881, 76900, 76905, 76910, 76911, 76912, 76913, 76928, 76956, 77010, 77014, 77025, 77032, 77052, 77109, TOB108, TOB110, TOB111, TOB114, TOB129, TOB133, TOB179, TOB184, TOB199 Case - #320518R2, K964215 Ford - #D7NN11390B, 2701E11390A Massey Ferguson - #390119M1</p>	

B5007-019	Denso 12-Volt Starter Solenoid	\$47.25
	<p>12 Volt Rated Solenoid for Denso Direct Drive Starters with 3 Terminals. Replaces: Denso - #046500-0010, 053400-1560, 053400-1720, 053400-2740, 053400-2870, 053400-3450, 053400-3490, 053400-3570, 053400-4530, 053400-6030, LA046500-0010 John Deere - #AR54991, AR55498, AR71256, AR90070, AR90074, RE13732</p>	

B5007-020	John Deere Bosch 12-Volt Solenoid	\$41.25
	<p>12 Volt Rated Solenoid with 3 Terminals for Bosch Starters. Used on John Deere Tractor Applications. Replaces: Bosch: #0331400023, 0331401001, 0331401003, 0331401004, 0331401012, 0331401029, 0331401046, 0331401051, 0331401501, 0331401503, 0331401504, 0331402073, 0331402074 John Deere: #AL19192</p>	

B5007-021	6-Volt Ford 8N Solenoid	\$75.50
	<p>24 Volt Rated Solenoid for Delco 40MT & 50MT Direct Drive Starters with 4 Terminals. Replaces: Delco - #1115526, 1119804, 1119832, 1119848, 1119849 Caterpillar - #4M-1812, 4R-7057, 7T-8858 Chrysler - #1889600 Ford - #C4TZ-11390A, John Deere - #AR-11075</p>	

B5007-022	Delco 24-Volt Solenoid	\$109.50
	<p>24 Volt Rated Solenoid for Delco 40MT & 50MT Direct Drive Starters with 4 Terminals & Threaded Plunger. Replaces: Delco - #1115504, 1115572, 1118053, 1118082, 1118173, 1118175, 1119803, 1119811, 1119813, 1119815, 1119951 Caterpillar - #1M-9982, 2L-6703, 2L-7920 John Deere - #AR11023</p>	

B5007-023	12-Volt Delco Starter Solenoid	\$69.75
	<p>12 Volt Rated Solenoid for Delco Starters with 4 Terminals. Replaces: Caterpillar - #661273 Delco - #1115569, 1118033, 1118051, 1118090, 1118171, 1118174, 1119805, 1119806, 1119812, 1119851, 1119950, 1119952 Fits: Delco Starters - (various applications) Fits Prestolite Starter - #MS2-503</p>	

B5007-024	Delco 12-Volt Solenoid	\$109.50
	<p>12 Volt Rated Solenoid for Delco 40MT & 50MT Direct Drive Starters with 4 Terminals. Replaces: Delco - #1119835, 1119853, 1119862, 1119879, 1119895 Case - #A47931 Caterpillar - #2N1973, 3T5045, 7L6586, 9X8236 Massey Ferguson - #1022662M91, 1055740M91 Mineapolis Moline - #30-3090892 Oliver - #30-3090892, 30-3370895</p>	

****For Applications, check the Machinery/Vehicle sections of the catalog****

B5007-025	12-Volt Isolated Base Solenoid	\$31.50
	<p>Has a Flat Bracket & 3 Terminal Post. Works with 12 Volt Systems. Isolated base/ isolated ground. Replaces: Autolite/ Prestolite - #SW1, SW219 Delco - #DR1494, U925, U928 Ford - #NCA11450A, 21A-11450 Fits: Ford - 600, 620, 630, 640, 650, 660, 700, 740, 800, 820, 840, 850, 860, 900, 950, 960, 501, 541, 601, 611, 621, 631, 641, 651, 661, 671, 681, 701, 741, 771, 801, 811, 821, 841, 851, 861, 871, 881, 901, 941, 951, 961, 971, 981 with 4 cylinder gas)</p>	

B5007-026	12-Volt Delco 37MT Solenoid	\$50.00
	<p>12 Volt Rated Solenoid for Delco 37 MT Starters with 3 Terminals. Has a 3 Hole Mount. Additional Mounting Parts Included. Replaces: Delco - #1115609, 1115613, D904A, D914A Ford - #E7HZ-11390-B, SW2157 Fits: Delco Starters: (various applications) Ford Starters: #F3HT-11001-BA, F3HT-11001-BA, F3HZ-11002-C, F3HZ-11002-C, F3HZ-11002-CRM, F3HZ-11V002-CRM, F6HT-11001-CB, F6HZ-11002-CB, F8HZ-11002-AA</p>	

B5007-027	12-Volt Intermittent Duty Cycle Delco 42MT Solenoid	\$35.50
	<p>12 Volt Rated Intermittent Duty Cycle Solenoid for 42MT Starters with 4 Terminals. Replaces: Delco - #10456393, 1115593, 1115645 Ford - #E6HZ-11390-C, SW2195 Fits: Delco Starters – (various applications) Ford Starters – (various applications) Prestolite Starters – (various applications)</p>	

B5007-028	24-Volt Delco Starter Solenoid	\$49.75
	<p>24 Volt Rated Solenoid for Delco Starters with 4 Terminals. Replaces: Delco - #1114322, 1115513, 1115543, 1115583, 1115855, 1115888, 1119855, 1119888 Fits: Delco Starters - #1108612, 1108668, 1113130, 1113135, 1113147, 1113148, 1113162, 1113163, 1113190, 1113205, 1113210, 1113210, 1113242, 1114661, 1114671, 1114672, 12301359 John Deere Starters - #AR11138, AR28053, AR40134, SE501445, TY1470, TY2622, TY2666, TY6703 John Deere Tractors - 500, 600, 3010D, 3020D (up to Serial #122,999), 4010D, 4020D (up to Serial #200,999)</p>	

B5007-029	12 Volt Delco 35MT Solenoid	\$30.50
	<p>12 Volt Rated Solenoid for Delco Starters with 4 Terminals. Replaces: Caterpillar - #690814 Delco - #1115518, 1115522, 1115528, 1115530, 1115531, 1115541, 1115553, 1115584, 1115585 Fits: Delco Starters - (various applications) Prestolite Starter - #2500LC</p>	

B5007-030	24-Volt Delco Solenoid 42MT	\$50.75
	<p>24 Volt Rated Solenoid for Delco 42MT Starters with 4 Terminals. Replaces: Delco - #1115625, D919A Fits: Delco Starters - (various applications) Prestolite Starters - MS1-401A, MS1-401A, MS1-401A, MS1-401A, MS1-410A, MS1-410A, MS1-410A, MS1-410A, MS1-410A, MS1-410A, MS1-410A, MS1-410A</p>	

B5007-031	12-Volt Autolite/ Prestolite Starter Solenoid	\$32.75
	<p>24 Volt Rated Solenoid for Prestolite Starters with 3 Terminals. Note: color of solenoid may vary. Replaces: Chrysler - #1692659, 1889799 Prestolite - #15-1, 15-325, 15-4, 15-57, 15-61, 15-62, 15-63, 15-64, SAD-4401, SAD-4403, SAD-4501, SAD-4502 Fits: Chrysler Starters - #1642140, 1689342, 1770712, 1922641, 1941119 Ford Starter - B8C-11002-A Prestolite Starters - (various applications)</p>	

B5007-032	12-Volt Delco Solenoid	\$27.50
	<p>12 Volt Rated Solenoid for Delco Starters with 4 Terminals. Face-Mounted. Additional Mounting Parts Included. Replaces: Allis Chalmers - #1186987-2, 1306454-8, 243857, 4912314-4 Case - #104290A2R Caterpillar - #15116, 2L0775, 372501, 656576, 83011, 83091 Chrysler - #33202630, 33205022, 38130938, 8130938, DR-2302 Delco - #1114247, 1114251, 1114252, 1114253, 1114255, 1114256, 1114257, 1114262, 1114263, 1114264, 1114266, 1114268, 1114270, 1114271, 1114272, 1114273, 1114276, 1114277, 1114278, 1114279, 1114281, 1114282, 1114283, 1114287, 1114289, 1114290, 1114291, 1114294, 1114295, 1114297, 1114299, 1114303, 1114304, 1114306, 1114324, 1114325, 1114326, 1114328, 1114330, 1114331, 1114333, 1114334, 1114335, 1114336, 1114337, 1114339, 1114340, 1114341, 1114342, 1114343, 1114344, 1114345, 1114346, 1114347, 1114348, 1114349, 1114350, 1114351, 1114353...</p>	

...1114354, 1114355, 1114356, 1114357, 1114358, 1114359, 1114362, 1114364, 1114367, 1114369, 1114370, 1114376, 1114377, 1114378, 1114379, 1114380, 1114381, 1114388, 1114391, 1114394, 1114395, 1114396, 1114397, 1114398, 1114399, 1114430, 1114458, 1114459, 1114460, 1114461, 1114462, 1114464, 1114465, 1114466, 1114468, 1114474, 1114487, 1114488, 1114489, 1114493, 1114494, 1114495, 1114496, 1114499, 1114500, 1114502, 1114504, 1114505, 1114508, 1114510, 1114558, 1114565, 1114567, 1116481, 1116624, 1117271, 1118810, 1118811, 1118816, 1118821, 1119781, 1119798, 1119910, 1119919, 1119923, 1119936, 1119946, 1119967, 1119974, 1119980, 1119981, 1119986, 1119989, 1119998, 1119999, D1145, D1323, D1456, D914, D930, D931, D932, D933, D934, D942, D943, D948, D952, D956, D958, D960, D965, D966, D967, D968, D969, D974, D975, D977, D978, D979, D981, D982, D992

John Deere – AT11342T

Massey Ferguson - #1025-381-M91, 1047-083-M91, 1902-937-M91, 1903-175-M91

Prestolite - #15-235, 15-40, 15-4D, 90-178D

Fits:

Chrysler Starters - #3236659, 8982775002, 9896659, JR775002

Delco Starters – (various applications)

Ford Starters – #E2JL-11001-AA

Prestolite Starters - #20500190, 20513003, 20513003, 20513003, 20513003, 20513003, 20513530TBA, 35259620, 35261180

B5007-033 12-Volt Delco Solenoid \$19.75



12-Volt Rated Solenoid for Delco Starters with 4 Terminals. Has a 2 Hole Mount. Additional Mounting Parts Included. Replaces:
Delco - #1114557, 1114569, D907A, D991

Fits Delco Starters:

#10455008, 10455009, 10455045, 10455046, 10455058, 10465030, 10465039, 10465099, 10465100, 10495524, 10496524, 1109546, 19136207, 19136207, 19136216, 19136216, 1998476, 1998509, 1998512, 1998534, 1998542, 1998550

B5007-034 Premium 12-Volt Starter Solenoid \$39.75



12-Volt Solenoid for Hitachi Starters, Premium Quality Includes Additional Mounting Parts Replaces:
Hitachi - #2114-17616, 2114-27501, 2114-27602, 2114-37503, 2114-47503, 2114-67505, 2114-87504, 2114-87505, 23343M8000

Fits: **Delco** – 19085002

Hitachi – (various applications)

Prestolite - #20513064, 20513073

B5007-035 12-Volt Solenoid \$40.25



Premium 12-Volt Solenoid for Delco Starters with 3 Terminals. Fits:
Delco - (various applications)
Replaces:
Delco Starters- #10457055, 10478614

B5007-036 Premium 12-Volt Delco Starter Solenoid \$22.75



12-Volt Rated Premium Solenoid for Delco Starters with 4 Terminals. Additional Mounting Parts Included. Replaces:
Chrysler - #38133925, 83500937
Delco - #1114514, 1114515, 1114517, 1114518, 1114519, 1114520, 1114523, 1114525, 1114527, 1114529, 1114531,

1114570, 1114571, 1114576, D911A, D913A, D983, D984

Ford - #E3PZ-11390-A, SWG1957

Fits:

Chrysler Starters - #8134193, 8982775000, 8982775013, 8982775013, JR775000, JR775013

Delco Starters – (various applications)

Ford Starters – #E3TF-11000-AA, E3TZ-11002-B, E4TF-11000-AA

Prestolite Starters – #20513003, 20513530TBA, 35259620

B5007-037 12-Volt Delco Solenoid \$34.75



12-Volt Rated Solenoid for Delco Starters with 4 Terminals. Replaces:
Delco - #10457151, D937A
Fits:
Delco Starters – (various applications)
Ford Starters – (various applications)

B5007-039 12-Volt Bosch Starter Solenoid \$33.25





12-Volt Rated Solenoid for Bosch Starters with 3 Terminals. Has a Crimped Cap & 3 Hole Mount. Additional Mounting Parts Included. Replaces:
Bosch - #233940213
Ford - #F0NN-11390-AA
Fits:

Bosch Starter: #0001369020

B5007-043	12-Volt Solenoid for Lucas M50 Starters	\$34.00
	<p>12-Volt Rated Solenoid with 4 Terminals and Mounted to Lucas M50 Direct Drive Starters. Replaces: Lucas - #60933073, 60933080, 76943, 77015, TOB168, TOB177 Massey Ferguson - #579-488-M91</p>	
<p>Fits: Lucas Starters- #26369, 26369A/H, 26369D, 26403, 26404, 26404A, 26404A/D, 26420, 27536, 27536A Prestolite Starters- #20500968, 20500969 Massey Ferguson - (1956-2003)</p>		

B5007-045	Delco 24-Volt Starter Solenoid	\$41.75
	<p>24-Volt Rated Solenoid for Delco 42MT Direct Drive Starters with 4 Terminals. Replaces: Delco - #1115595, 1115601, 1115608 Caterpillar - #7T0258</p>	

B5007-046	Bosch 12-Volt Starter Solenoid	\$26.50
	<p>12-Volt Rated Solenoid for Bosch Starters. Replaces: Bosch - #0331301002, 0331301004, 0331301013, 0331301015, 0331303002, 0331303004, 0331303009, 0331303013, 0331303018, 0331303023, 0331303026, 0331303028, 0331303032, 0331303034, 0331303055, 0331303066, 0331303073, 31075, 31110 Ford - #84AB11000AC</p>	

B5007-047	12-Volt Prestolite Solenoid	\$21.50
	<p>12-Volt Rated Solenoid for Prestolite Starters with 4 Terminals. Additional Mounting Parts Included. Replaces: John Deere - AT40955, AT68973, RE170320, RE38391 Prestolite - 15-274, 15-360, 15-391, 15-418, 15-441, SAZ4201AW, SAZ4201BR, SAZ4201CJ, SAZ4201R</p>	
<p>Fits: John Deere - (various applications)</p>		



B5007-048	Premium 12-Volt Bosch Starter Solenoid	\$34.75
	<p>12-Volt Rated Solenoid for Bosch Starters with 3 Terminals, Premium Quality. Additional Mounting Parts Included. Replaces: Bosch - #2339402149 John Deere - #RE503357 Fits: Bosch Starters - #0001230002, 0001230018</p>	

B5007-050	12-Volt Bosch Starter Solenoid	\$17.75
	<p>12-Volt Rated Solenoid for Bosch Starters with 3 Terminals. Spring Included. Replaces: Bosch - #0 331 400 014, 0 331 400 016, 0 331 400 017, 0 331 400 022, 0 331 401 007, 0 331 401 507, 0 331 402 076 Fits: Bosch Starters - #0 001 358 017, 0 001 358 018, 0 001 358 026, 0 001 358 033, 0 001 358 035, 0 001 358 038, 0 001 358 044, 0 001 358 046, 0 001 358 047 John Deere Starters - #AR70436 John Deere Tractors - 820 (German built)</p>	

B5007-051	12-Volt Delco Starter Solenoid	\$34.75
	<p>12-Volt Rated Solenoid for Delco Starters with 4 Terminals. Replaces: Delco - 1119968, D941, D944, D945, D946, D947, D949, D950, D951 Ford - SWX229 Prestolite - 90-174D, SAM-4101T Fits: Delco Starters - 1107252, 1107309, 1107511, 1107518, 1107532, 1107535, 1107609, 1107610, 1107619, 1107620, 1107621, 1107622, 1107623, 1107626, 1107627, 1107629, 1107631, 1107632, 1107633, 1107635, 1107638, 1107639, 1107640, 1107642, 1107643, 1107644, 1107645, 1107646, 1107648, 1107648, 1107649, 1107653, 1107656, 1107670, 1107672, 1107673, 1107674, 1107675, 1107677, 1107684, 1107725, 1107737, 1107764, 1107772, 1107779, 1108621, 1108640, 1108641, 1108643, 1108643, 1108644, 1108648, 1108653, 1108658, 1108671</p>	

B5007-052	12-Volt Solenoid with Bakelite Case for Ford Tractors	\$17.75
	<p>Has a Flat Mounting Bracket & is 12 Volts. It has 4 Terminals with a Bakelite Housing. It has 5/16-24 Thread for Battery and Motor Post and a 10-32 Post for the Terminal Switch. Replaces: Prestolite - #15-104 Ford/ Motorcraft - #311006, SW220 Fits: Ford Tractor- 2000, 2110 (with 3-158 Gas/Diesel Engine), 3000, 3400, 3550, 4000 (with 3-201 Diesel Engine), 4110, 4400, 4410 (with 3/192 Gas Engine 3-201 Diesel), 5000, 6600, 6700, 7000 (Gas or Diesel)</p>	

MASTER SWITCHES

B5008-002	Battery Master Switch	\$30.00
	Premium Quality, Made in the USA	
B5008-003	Battery Master Switch Face Plate	\$3.50
	For use with B5008-002 master switch	

DASH LAMPS





B9016-013	Chrome Finish Dash Lamp	\$19.75
	6 or 12 Volt, Chrome Finished Dash Lamp. Bulb not included. 6 Volt Use Bulb #B9017-046 12 Volt Use Bulb #B9017-049 Replaces: John Deere - #AD2835R, AR26757R, B1728R, AR1563R, AR20447R, AD2834R, AD1855R, AD2082R Massey Ferguson - #762269M91 Massey Harris - #762269M91 Minneapolis Moline - #JT1380B, JT1380A	
B9016-014	Black Finish Dash Lamp	\$19.75
	6 or 12 Volt, Black Finished Dash Lamp. Bulb not included. 6 Volt Use Bulb #B9017-046 12 Volt Use Bulb #B9017-049 Replaces: John Deere - #AD2835R, AR26757R, B1728R, AR1563R, AR20447R, AD2834R, AD1855R, AD2082R Massey Ferguson - #762269M91 Massey Harris - #762269M91 Minneapolis Moline - #JT1380B, JT1380A	

****For Applications, check Machinery/Vehicle section of catalog****

Light Bulbs

B9017-046	6 Volt Bulb	\$1.25
B9017-049	12 Volt Bulb	\$1.25
	Light bulbs for products #B9016-013, B9016-014	

Light Contact Leads

B9017-079	Universal Double Contact Lamp Socket Pigtail for 5/8" Bulb Base	\$2.00
	Used for various 2 contact lamps (Park/Turn & Stop/Turn Lights) 0.600" washer	
B9017-111	Universal Single Contact Lamp Socket Pigtail for 5/8" Bulb Base	\$2.00
	Generic Wire Lead Replacement 0.600" washer	
B9017-087	Single Lead Miniature Lamp Socket Pigtail for 5/8" Hole	\$4.75
	Warning Light/ Tell-Lite Socket for Charge Indicator Lights Replaces: 2505 Fits: (various)	
B9017-096	Isolated Lamp Pigtail for 5/8" Hole	\$6.75
	Warning Light/ Tell-Lite Socket for Charge Indicator Lights Fits: Case - 200, 300, 400, 500, 600, 700, 800 series, 970 Ford - 501, 541, 601, 611, 621, 631, 641, 651, 661, 671, 671, 681, 701, 741, 771, 801, 811, 821, 841, 851, 861, 871, 881, 901, 941, 951, 961, 971, 981, 1801, 1811, 1821, 1841, 1871, 1881, 2000, 2030, 2031, 2110, 2111, 2120, 2130, 2131, 4000, 4030, 4031, 4040, 4120, 4121, 4130, 4131, 4140, (2000, 3000, 4000- 3 cyl. Prefix C with Generator), 6000 IHC/Farmall - 600, 606, 656, 664, 666, 706, 756, 766, 806, 826, 856, 966, 1026, 1066, 1206, 1256, 1456, 1466, 1468 John Deere - Diesel 70, 80, 720, 820, 730, 830, 840, 2020, 2030, 2240, 2520, 3020, 4020, 4520, 5020 Oliver - 440, 550, 770, 880	

Lamp Contacts

B9017-110	Small Lamp Contact	
	Qty 1-9	\$0.45
	Qty 10-25	\$0.35
	Qty 26-99	\$0.30
	Qty 100-499	\$0.27
	Qty. 500-999	\$0.23
	Qty. 1000+	\$0.21

FLASHERS

B9017-040	6-Volt Thermal Flasher	\$9.75
	6-Volt Thermal Flasher, Three Terminal Replaces: #535 Fits: Cadillac - 1940-52, Chevrolet - 1948-54 Chrysler - 1941-55, Ford - 1949-52 Jeep - 1933-60, Oldsmobile - 1946-52, Pontiac - 1946-54	

AUXILIARY PLUGS

B9032-001	2 Pole Auxiliary Plug	\$23.75
	**For Applications, Check Machinery/Vehicle Section of Catalog**	
B9032-002	2 Pole Auxiliary Connector	\$19.75
	(Used With B9032-001)	

REPAIR KITS

B4017-052	Wico Basic Repair Kit	\$49.00
	Includes: Cover gasket, Points, Condenser, Felt wiper package, 6 Screws for points & condenser, Bearing seal, Oil slinger, and more. Replaces: John Deere - #AR12012R, Wico - #390-5068, K9358 Fits Wico XH Magnetos XH10, XH11, XH16, XH17, XH19, XH20, XH22, XH23, XH29, XH32, XH41, XH55, XH79, XH81, XH113, XH115, XH131, XH139, XH145, XH150, XH156, XH157, XH169, XH175, XH184, XH192, XH212, XH241, XH246, XH257, XH261, XH264, XH274, XH305, XH307, XH404, XH414, XH438, XH456, XH457, XH469, XH473, XH477, XH494, XH514, XH520, XH522, XH524, XH556, XH557, XH564, XH565, XH623, XH631, XH633, XH635, XH636, XH731, XH732, XH733, XH734, XH787, XH791, XH870, XH873, XH887, XH894, XH909, XH926, XH936, XH951, XH960, XH962, XH970, XH973, XH977, XH980, XH1007, XH1022, XH1023, XH1042, XH1053, XH1059, XH1072, XH1088, XH1113, XH1128, XH1131, XH1137, XH1140, XH1141, 1141B, XH1142, XH1163, XH1166, XH1180, XH1215, XH1222, XH1261, XH1263, XH1277, XH1280, XH1283, XH1292, XH1295, XH1295B, XH1295Y, XH1297, XH1300, XH1308, XH1309, XH1310, XH1325, XH1343, XH1344, XH1354, XH1438, XH1449, XH1454, XH1515, XH1535, XH1572, XH1593, XH1604, XH1648, XH1686, XH1714,	

XH1733, XH1748, XH1769, XH1806, XH1869, XH1886, XH1906, XH1907, XH1908, XH1909, XH1916, XH1917, XH1921, XH1950, XH1951, XH1993, XH1994, XH2002, XH2006, XH2012, XH2023, XH2043, XH2059, XH2075, XH2081, XH2092, XH2098, XH2108, XH2113, XH2114, XH2115, XH2138, XH2148, XH2168, XH2175, XH2207, XH2208, XH2239, XH2279, XH2286, XH2302, XH2392, XH2500, XH3000, XH3001
--

B9030-002	12 Volt Cigarette Lighter	\$29.99
	With Anodized Aluminum Knob Engraved with the word Lighter Replaces: Allis Chalmers - #230228, 232810, 230236, 70230236, 229502, 228343, 70229502, 70232810, 70230228, 70228343 Case - #A24134, G13345, A24082, G13344 Cockshutt - #T17846, TO16481, T17847, 31-1647093 International - #367904R91, 12 Volt: 362000R91 John Deere - #AT26407, AR60937, AA5734R, AR21327, AR20438R, AA5787R, AR30052, AR34556, AR48643, AR46079 Massey Harris - #765433M91 **For Applications, Check Machinery/Vehicle Section of Catalog**	

IDENTIFICATION TAGS

Autolite



B9013-001	Small Autolite I.D. Tag (Blank)	\$7.00
	Small Autolite I.D. Tag (Stamped)	\$14.25
	2 5/16" Long, Black I.D. Tag for Distributors, Starters, & Generators with Rivets	
B9013-002	Large Autolite I.D. Tag (Blank)	\$7.00
	Large Autolite I.D. Tag (Stamped)	\$14.25
	2 15/16" Long, Black I.D. Tag for Distributors, Starters, & Generators with Rivets	

Delco Remy

B9013-003	Large Delco Remy I.D. Tag (Blank)	\$9.00
	Large Delco Remy I.D. Tag (Stamped)	\$16.25
	Large Black Delco-Remy I.D. Tag for Distributors, 6 Volt Starters, & 6 Volt Generators with Rivets, 1 1/4" X 2 7/8"	
B9013-004	Delco Remy I.D. Tag (Blank)	\$7.00
	Delco Remy I.D. Tag (Stamped)	\$14.25
	Black Delco-Remy I.D. Tag for Distributors, 6 Volt Starters, & 6 Volt Generators with Rivets, 3/4" 2 5/16"	

B9013-005	Red Delco Remy I.D. Tag (Blank)	\$7.00
	Red Delco Remy I.D. Tag (Stamped)	\$14.25
		Red Delco-Remy I.D. Tag for 12 Volt Starters & 12 Volt Generators with Rivets, 3/4" 2 5/16"
B9013-006	Orange Delco Remy I.D. Tag (Blank)	\$7.00
	Orange Delco Remy I.D. Tag (Stamped)	\$14.25
		Orange Delco-Remy I.D. Tag for 24 Volt Starters, & 24 Volt Generators with Rivets, 3/4" 2 5/16
B9013-013	Delco Remy I.D. Tag (Blank)	\$7.00
	Delco Remy I.D. Tag (Stamped)	\$14.25
		Black Delco-Remy I.D. Tag for Distributors, 6 Volt Starters, & 6 Volt Generators with Rivets, 3/4" 2 5/16"

IHC/Farmall

B9013-007	IHC I.D. Tag	\$21.99
		IHC/Farmall Serial Number Tag (Size 2 1/4" x 4") Fits: CUB, A, B, C, H & M (Early Style 1939-49)
B9013-008	IHC I.D. Tag	\$21.99
		IHC/Farmall Serial Number Tag (Size 2 1/4" x 4") Fits: CUB, A, B, C, H & M (Later Style 1950 & Up)
B9013-015	IHC I.D. Tag	\$21.99
		IHC/Farmall Serial Number Tag (Size 2 1/4" x 4") Fits: [Cub, Super W9, Super WD9, Super WDR9, T340, TD340, WR9S, 100, 130, 140, 200, 230, 240, 300, 330, 340, 350, 400, 404, 450, 460, 560, 600, 650, 660 (YEAR 1956 AND UP)], [424, 504, 606, 656 (THRU 1964)], Cub LoBoy: Cub Loboy (YEAR 1956 AND UP, EXCEPT 154, 184, 185), Wheatland: 400, 450 (YEAR 1956 AND UP)

Massey-Harris Ferguson

B9013-014	Massey Harris/ Ferguson Tag	\$32.99
		Massey Harris/ Ferguson Serial Number Tag (Size 3 5/16" x 1 15/16") Fits: Massey Harris, 50 Series/ Massey Ferguson 40, TO-35, 50, 202, 204, 2135, 135, 35

WICO

B9013-009	WICO EK Nameplate	\$9.00
		Fits the WICO EK Magneto (Rivets included)
B9013-010	WICO Series C Nameplate	\$7.00
		Fits the WICO Series C Magneto (Rivets included)
B9013-011	WICO Series X Nameplate	\$7.00
		Fits the WICO Series X Magneto (Rivets included)
B9013-012	WICO B4027 Nameplate	\$7.00
		Fits the WICO B4027 Distributor (Rivets included)

ALTERNATORS

Note: all our 1-Wire Alternators are Self-Exciting.

Also, our Alternators have 3/8" Belt Width Pulleys unless otherwise stated. All 10SI type and Small ND type alternators are Internally Regulated.

Delco 10SI Type

B6001-001	12-Volt, Low Speed Alternator (1 Wire, Negative Ground)	\$112.75
		Low Cut In, 63 Amp, Negative Ground. Specially Built For Tractors, Forklifts, & Other Low Engine Speed Applications. Will also work well with normal speed applications. Note: Will not allow the warning lamp to function.

B6001-002	12 Volt, 1 Wire/ 3 Wire Alternator	\$118.75
	63 Amp, Negative Ground Used For Warning Lamp On Automobiles & Trucks. Can be used as a 10SI Delco type (3-Wire) alternator or as a 1-Wire alternator. Can also allow the warning lamp to function.	
	B6001-003	\$158.50
	12-Volt Alternator 100 Amp, Negative Ground 1 Wire. Can also use the warning lamp/excite plug to allow the warning lamp to function.	
	B6001-004	\$123.50
	12-Volt Chrome Alternator 100 Amp, Negative Ground 1-Wire. Note: Will not allow the warning lamp to function. Chrome-plated.	
	B6001-005	\$166.50
	6-Volt Alternator 40 Amp, Positive Ground, 1-Wire	
	B6001-006	\$166.50
	6-Volt Alternator 40 Amp, Negative Ground, 1-Wire	
	B6001-007	\$159.75
	12-Volt Alternator 63 Amp, Positive Ground, 1-Wire	
	B6001-008	\$139.50
	24-Volt Alternator 40 Amp, Negative Ground, 1-Wire	
	B6001-009	\$199.75
	24-Volt Alternator 40 Amp, Isolated Ground, 1-Wire	

	B6001-010	\$191.00
	12-Volt Alternator 100 Amp, Positive Ground, 1-Wire	
	B6001-011	\$129.75
	12-Volt Alternator with Mechanical Tachometer Drive 63 Amp, Negative Ground, 1-Wire, Internally Regulated, 1/2" Groove Pulley	
	B6001-012	\$111.25
	12 Volt Alternator Low Cut In, 1/2" Pulley As B6001-001 above, but has a 1/2" Pulley.	
	B6001-013	\$113.75
	12 Volt Alternator Low Cut In, 5/8" to 3/4" Pulley As B6001-001 above, but has a 5/8" to 3/4" Pulley.	
	B6001-014	\$129.75
	12 Volt Alternator 1 Wire/3 Wire, 1/2" Pulley As B6001-002 above, but has a 1/2" Pulley.	
	B6001-015	\$129.75
	12 Volt Alternator 1-Wire/3-Wire, 5/8" to 3/4" Pulley As B6001-002 above, but has a 5/8" to 3/4" Pulley.	

Small ND/ Denso Type

B6002-003	12 Volt Small Alternator (1-Wire)	\$119.75
	40 Amp, 1 Wire Internal Regulator Will Start Charging with a Much Lower Engine Speed. Comes with a 4 1/2" Housing Diameter, 3/8 To 1/2" Belt width & a 2 1/2" Pulley Diameter. Perfect for the Machine that Requires a Smaller Alternator & for Converting 6 - to 12-Volt. Negative Ground Only & is Self-Excited.	

Delco 10DN Type

	B6003-001	\$139.75
	12-Volt Alternator 63 Amps Not internally regulated	

ALTERNATOR COMPONENTS

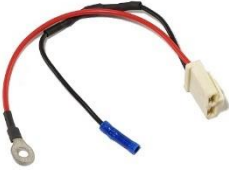
B3000-001	Delco 10SI Alternator Adaptor Plug	\$14.75
	Connects to the back of 10SI Delco alternators, such as B6001-002 . Includes diode to prevent voltage feedback. Doesn't work with 1-wire alternators.	

ALTERNATOR PULLEYS

1-Groove Alternator/Generator Pulleys

B9028-018	Alternator/Generator Pulley	\$10.50
	3/8" (10mm) Belt Width, 2.89" Outside Diameter, 17mm Inside Diameter, 1.33" Offset, Includes 2 Shims Can Be Used On #B6001 Series (17mm Shaft) Alternators	
B9028-020	Alternator/Generator Pulley	\$12.50
	3/8" (10mm) Belt Width, 2.933" Outer Diameter, 17mm Inside Diameter Fits: Hitachi Alternators Can Be Used On #B6001 Series (17mm Shaft) Alternators	
B9028-003	Alternator/Generator Pulley	\$5.75
	3/8" Belt Width, 2 5/8" Outside Diameter, 17mm Inside Diameter Replaces Delco : #10476394, #10495192, #1893675, #192, #1939845, #1949355, #1949356, #1949357, #1970757 Ford : #C5AZ-10344-K, #C9AF-10A352-B, #E87F-10A352-AA, #E8TZ-10344-A, #GP493, #GP652 Can Be Used On #B6001 Series (17mm Shaft) Alternators	
B9028-023	Alternator/Generator Pulley	\$7.75
	7/16" Belt Width 2.5" Outside Diameter 17mm Inside Diameter Can Be Used On #B6001 Series (17mm Shaft) Alternators	
B9028-001	Alternator/Generator Pulley	\$6.75
	1/2" Belt Width, 2 5/8" Outside Diameter, 17mm Inside Diameter Replaces: Delco - #1939886, #1961291 Can Be Used On #B6001 Series (17mm Shaft) Alternators	

B9028-005	Alternator/Generator Pulley	\$12.75
	1/2" Belt Width, 3" Outside Diameter, 17mm Inside Diameter Replaces Allis Chalmers : #70250599 Can Be Used On #B6001 Series (17mm Shaft) Alternators	
B9028-006	Alternator/Generator Pulley	\$9.84
	1/2" Belt Width, 3 3/16" Outside Diameter, 17mm Inside Diameter Replaces John Deere : #R52159 Can Be Used On #B6001 Series (17mm Shaft) Alternators	
B9028-021	Alternator/Generator Pulley	\$12.50
	1/2" Belt Width, 3.37" Outer Diameter, 17mm Inside Diameter Replaces Ford : D3JL-10130-D1 Delco : #1961988 Can Be Used On #B6001 Series (17mm Shaft) Alternators	
B9028-022	Alternator/Generator Pulley	\$17.75
	1/2" Belt Width, 3.467" Outer Diameter, 15mm Inside Diameter Replaces Ford : #C5NF10196B Lucas : #81812544 Can Be Used On #B6002 Series (15mm Shaft) Alternators	
B9028-026	Denso Alternator Pulley	\$16.50
	1/2" Belt Width, 2.93" Outside Diameter, 15mm Inside Diameter Can Be Used on #B6002 Series (15mm Shaft) Alternators	
B9028-029	Denso Alternator Pulley	\$14.00
	1/2" Belt Width, 2.717" Outside Diameter, 15mm Inside Diameter, Offset - .31" (8mm), (Does not have a keyway) Used On #B6002 Series (15mm Shaft) Alternators	
B9028-024	Alternator/Generator Pulley	\$72.94
	1/2" Belt Width, 3.22" Outside Diameter, 5/8" 15.88mm Inside Diameter, Replaces John Deere : #R15019 Can Be Used On #B6002 Series (15mm Shaft) Alternators	

B9028-037	Denso Alternator Pulley	\$19.75
	One V Groove, 15 mm Belt Width, 15 mm Inner Diameter Replaces: Denso – #021041-7340 John Deere – #R105245	
B9028-004	Alternator/Generator Pulley	\$12.25
	5/8" Belt Width, 3 1/16" Outside Diameter, 17mm Inside Diameter Replaces Prestolite : #34-388, #PU-598G Case : #A45231 Delco : #1846529 Can Be Used On #B6001 Series (17mm Shaft) Alternators	
B9028-010	Threaded Generator Pulley	\$16.75
	5/8" Belt Width, 3.69" Outside Diameter, Threaded Bore Replaces Ford : #9N10130, #9N10130A Used on Generators	
B9028-011	Alternator/Generator Pulley	\$25.75
	5/8" Belt Width, 2.717" Outside Diameter, 15mm Inside Diameter Can Be Used On #B6002 Series (15mm Shaft) Alternators	
B9028-017	Alternator/Generator Pulley	\$16.52
	5/8" Belt Width, 3.69" Outer Diameter, 17mm Inside Diameter Replaces Ford : #8N-10130, 8N-10130A Can Be Used On #B6001 Series (17mm Shaft) Alternators	
B9028-002	Alternator/Generator Pulley w/ Hex Nut	\$9.75
	5/8- 3/4" Belt Width, 2 1/2" Outside Diameter, 17mm Inside Diameter Includes Hex Nut Can Be Used On #B6001 Series (17mm Shaft) Alternators	
B9028-013	Alternator/Generator Pulley	\$27.75
	3/4" Belt Width, 2.717" Outside Diameter, 15mm Inside Diameter Can Be Used On #B6002 Series (15mm Shaft) Alternators	

2-Groove Alternator/Generator Pulleys

B9028-008	2 Groove Alternator/Generator Pulley	\$8.50
	3/8" Belt Width, 2 5/8" Outside Diameter, 17mm Inside Diameter Replaces Delco : #1846787, #1964758, #1968354, #1970830, Ford : #C5AZ-10344-L, #C5TF-10A352-K2, #C9AF-10A352-C, #E4TZ-10344-B, #E6SF-10A352-AA, #E6SZ-10344-A, #GP494, #GP617, #GP629 Can Be Used On #B6001 Series (17mm Shaft) Alternators	
B9028-014	2 Groove Alternator/Generator Pulley	\$14.75
	1/2" & 3/8" Belt Width, 3 3/8" Outside Diameter, 17mm Inside Diameter Replaces Ford : #E3TF-10A352-AA, #E3TZ-10344-A, #E9TF-10A352-AA, #E9TZ-10344-A, #GP609, #GP609A Can Be Used On #B6001 Series (17mm Shaft) Alternators	
B9028-034	2-Groove Delco Alternator/Generator Pulley	\$12.75
	10mm Belt Width, 69.9mm Outside Diameter, 17mm Shaft Diameter, V-Grooves Replaces: Delco - #1938093, 1940345, 1960536, 1961408, 1962998, 1966002, 1970830 Ford - #C5AZ10344L, GP421, GP464, GP472, GP494 John Deere - #AT17054 Can Be Used On #B6001 Series (17mm Shaft) Alternators	
B9028-038	Denso 2-Groove Alternator Pulley	\$19.75
	Two V Grooves, 11 mm Belt Width, 15 mm Inner Diameter Replaces - Denso – #021041-7890	
B9028-009	Alternator/Generator Pulley	\$13.75
	1/2" Belt Width, 3 1/4" Outside Diameter, 17mm Inside Diameter Replaces Delco : #1949916 Caterpillar : #86387 John Deere : #R11189 Can Be Used On #B6001 Series (17mm Shaft) Alternators	
B9028-012	2 Groove Alternator/Generator Pulley	\$14.50
	1/2" Belt Width, 2 13/16" Outside Diameter, 17mm Inside Diameter Replaces Delco : #1877007, #3947125 Can Be Used On #B6001 Series (17mm Shaft) Alternators	

B9028-036	2 Groove Prestolite Alternator Pulley	\$21.49
	16mm Belt Width, 0.807" Outside Diameter, 22.2mm Inside Diameter Replaces – Case: #A44442 Prestolite: #34-399, PU-697 Can Be Used On #B6001 Series (17mm Shaft) Alternators	
B9028-015	2 Groove Alternator/Generator Pulley	\$12.75
	1/2" Belt Width, 3 3/16" Outside Diameter, 17mm Inside Diameter Replaces John Deere: #R81507 Can Be Used On #B6001 Series (17mm Shaft) Alternators	
B9028-016	2 Groove Alternator/Generator Pulley	\$7.00
	1/2" Belt Width, 2 15/16" Outside Diameter, 17mm Inside Diameter Replaces Ford: #F1HU-10A352-AB, #F1HZ-10344-A, #GP688 Can Be Used On #B6001 Series (17mm Shaft) Alternators	
B9028-019	2 Groove Alternator/Generator Pulley	\$13.25
	1/2" Belt Width, 3" Outer Diameter, 7/8" Inside Diameter Used on Delco 30SI/TR Series Alternators	
B9028-030	2-Groove Alternator Pulley	\$22.25
	1/2" Belt Width, 3 1/2" Outside Diameter, 7/8" Inside Diameter Fits: Delco - #1117880, 1117894, 1117930, 1117931, 1117954, 1117955, 1117956 Ford - #F3HT-10300-AA, F3HT-10300-BA, F3HT-10300-CA, F4HT-10300-DA, F4HT-10300-EA, F4HT-10300-FA, F4HT-10300-KA, F5HZ-10346-A	
B9028-032	Motorola/ Prestolite 2-Groove Alternator Pulley	\$16.75
	1/2" Belt Width, 3.11" Outside Diameter, 5/8" Inside Diameter Replaces: Motorola - #7-43, Prestolite - #107-43 Fits: Motorola - (various) Prestolite - #110-146, 110-148, 110-170, 110-216, 110-240, 110-241, 110-479, 110-60	
B9028-035	2-Groove Cummins/Delco Alternator Pulley	\$21.50
	1/2" Belt Width, 3.50" Diameter, 7/8" Bore with Keyway Replaces: Cummins - #213326 Delco - #1938553 Prestolite - #34-111	

B9028-031	Delco 2-Groove Alternator Pulley	\$14.50
	0.512" Belt Width, 3.126" Outside Diameter, 0.874" Inside Diameter Replaces: Delco - #1953071, 1962567 Fits: Delco - #1101251	
B9028-007	2 Groove Alternator/Generator Pulley	\$27.25
	5/8" Belt Width, 4 3/8" Outside Diameter, 17mm Inside Diameter Replaces IHC/Farmall: #537070-R1 Used On #B6001 Series (17mm Shaft) Alt.	
B9028-025	2-Groove Alternator Pulley	\$28.75
	0.866" (22mm) Belt Width, 3.752" (95.3mm) Outside Diameter, 0.874" (22.2mm) Inside Diameter, 0.157" (4mm) Keyway Width. Fits Delco 20SI & Prestolite ANB Series Alternators on Caterpillar Applications. For V-Groove Type Belts.	
B9028-033	2-Groove Delco Alternator/Generator Pulley	\$19.75
	16mm Belt Width, 79mm Outside Diameter, 17mm Shaft Diameter Replaces Case: #L59716 Can Be Used On #B6001 Series (17mm Shaft) Alternators	

ALTERNATOR BRACKETS

B9014-001	Universal Alternator Mounting Bracket	\$49.75
	Universal Alternator Mounting Bracket that converts from a generator to an alternator. Does Not Include Top Adjusting Arm	

FUEL SYSTEM ACCESSORIES

B9038-022	Side-Vented Fuel Cap	\$11.99
	Side vent, 2.725" inside diameter, 2.886" outside diameter, 5/8" height, includes gasket See our website for more dimensions and fits.	
B9038-021	Rubberized Cork Fuel Cap Gasket	\$2.59
Used with B9038-022 above.		

COMPLETE CARBURETORS

B6200-001	New Zenith Universal Replacement Carburetor	\$286.99
	Appearance may vary from original carburetor. For some applications, the length of the throttle shaft may need to be trimmed. See our website for fits. Note: This item is not returnable if installed or has had fuel put in it.	

IGNITION COILS

The Brillman Company Coils



**Premium Quality
Super-Hot, 60,000 Volt**
Our Super Stinger Ignition Coils
Are Custom Made & Are The Hottest
Available. Will Produce The Most
Horse Power, Faster Starts, & Longer
Plug Life By Reducing Plug Fouling.

EB1SS	1.5 OHM Black Coil, 6 Volt Does Not Need A Ballast Resistor Can Be Wired Directly to 6 Volts	\$47.75
EB30SS	1.5 OHM Black Coil, 12 Volt	\$47.75
EB40SS	3.0 OHM Black Coil, 12 Volt Does Not Need A Ballast Resistor Can Be Wired Directly to 12 Volts	\$47.75



**Premium Quality
Hot, 55,000 Volt**

EB1	1.5 OHM Black Coil, 6 Volt Does Not Need A Ballast Resistor Can Be Wired Directly to 6 Volts	\$37.50
EB30	1.5 OHM Black Coil, 12 Volt	\$37.50
EB40	3.0 OHM Black Coil, 12 Volt Does Not Need A Ballast Resistor Can Be Wired Directly to 12 Volts	\$37.50



**Standard Quality
30,000 Volt**

EB1E	1.5 OHM Black Coil, 6 Volt Does Not Need A Ballast Resistor Can Be Wired Directly to 6 Volts	\$19.75
EB30E	1.5 OHM Black Coil, 12 Volt	\$19.75
EB40E	3.0 OHM Black Coil, 12 Volt Does Not Need A Ballast Resistor Can Be Wired Directly to 12 Volts	\$19.75

Pertronix Flame Thrower Coils

	40,000 Volt		
	B40001	1.5 OHM Chrome Coil	\$52.45
	B40011	1.5 OHM Black Coil	\$49.95
	B40111	1.5 OHM Black Epoxy Coil	\$59.95
	B40501	3.0 OHM Chrome Coil	457.95
	B40511	3.0 OHM Black Coil	\$49.95
B40611	3.0 OHM Black Epoxy Coil	\$59.95	
B45011	45,000 Volt, 0.6 Ohms, Low Resistance For 6-volt, 8 cyl. systems		\$59.45

Ignition Coil Accessories

	B4008-014	\$3.50
	Coil Bracket Fits All Standard Automotive & Tractor Distributor Coils. Clear Zinc Finish.	
	B4008-006	\$8.25
	Ballast Resistor Offers .6 to 1.5 Ohms Resistance Used with EB30 & EB30E Coils	

***Also see the inside of the back cover to determine which ignition coils you should buy.**

ALLIS CHALMERS

TABLE OF CONTENTS

Spark Plug Wire Sets	45
Battery Cables	46
Wire Harnesses	47
Tune Up Parts for Battery Ignition	49
Electronic Ignition Conversion Kits	51
Tune Up Parts for Magneto Ignition	51
Replacement Magnetos	54
Gauges	54
Switches	56
Cutout Relays & Voltage Regulators	57
Generator Bearing & Brush Sets	58
Starter Switches & Solenoids	59
Starter Brush Sets & Bearings	59
Identification Tags	59
Alternators	60
Alternator Brackets	60
Lights & Light Parts	60
Auxiliary Plugs & Sockets	63
Cigarette Lighter	63
Carburetor Rebuild Kits	63
Carburetor Floats	64
Carburetor Accessories	65
Fuel Sediment Bowls	65
Complete Distributors	65

Allis Chalmers A

4 Cyl. Tailored Spark Plug Wire Set

B1001-019	Original Type Cotton Braid Wire	\$25.25
B1001-019E	EPDM Wire	\$27.25

Allis Chalmers B, C, RC with Magneto

4 Cyl. Tailored Spark Plug Wire Set

B1001-002	Original Type Cotton Braid Wire	\$20.75
B1001-002E	EPDM Wire	\$22.75

Allis Chalmers B, C, CA with Distributor

4 Cyl. Tailored Spark Plug Wire Set

B1001-004	Original Type Cotton Braid Wire	\$22.00
B1001-004E	EPDM Wire	\$24.00
B1001-004S	Suppression Wire	\$24.00
B1001-004CS	Cotton Suppression Wire	\$37.75

Allis Chalmers D10, D12, D14, D15, I60

4 Cyl. Tailored Spark Plug Wire Set

B1001-005	Original Type PVC Wire	\$22.00
B1001-005E	EPDM Wire	\$24.00
B1001-005S	Suppression Wire	\$24.00

Allis Chalmers D17

4 Cyl. Tailored Spark Plug Wire Set

B1001-020	Original Type PVC Wire	\$20.50
B1001-020E	EPDM Wire	\$24.50
B1001-020S	Suppression Wire	\$24.50

Allis Chalmers D19 Gas

6 Cyl. Tailored Spark Plug Wire Set

B1001-018	Original Type PVC Wire	\$30.25
B1001-018E	EPDM Wire	\$36.50
B1001-018S	Suppression Wire	\$36.50

Allis Chalmers G

4 Cyl. Tailored Spark Plug Wire Set

B1001-010	Original Type Cotton Braid Wire	\$25.25
B1001-010E	EPDM Wire	\$27.25
B1001-010S	Suppression Wire	\$27.25
B1001-010CS	Cotton Suppression Wire	\$43.00

Allis Chalmers I60 (See B1001-005 above)

Allis Chalmers M, U with Magneto

4 Cyl. Tailored Spark Plug Wire Set

B1001-012	Original Type Cotton Braid Wire	\$25.25
B1001-012E	EPDM Wire	\$27.25

Allis Chalmers WC, WD, WF with Magneto

4 Cyl. Tailored Spark Plug Wire Set

B1001-014	Original Type Cotton Braid Wire	\$22.75
B1001-014E	EPDM Wire	\$24.50

SPARK PLUG WIRE SETS

Our Spark Plug Wire Sets Come Fully Assembled with the Proper Type Wire & Terminals.

They are Custom Tailored to Look & Fit Like Original Factory Equipment.

Varieties include:

Cotton Braid Wire: Copper Core with a Cotton Jacket.

PVC Wire: Copper Core with a Rubber Jacket.

EPDM Wire (E): Hi Performance Premium Conductor with a Tinned Copper Core, EPDM Silicone Insulation, and a Rubber Jacket.

Suppression Wire (S): for Electronic Ignition and is Spiral Wound, Ultra Low-Ohm, with EPDM Silicone Insulation and a Rubber Jacket.

Cotton Braid Suppression Wire (CS): also for Electronic Ignition, as Suppression Wire, but has an additional layer of Cotton Braid & Lacquer to replicate the vintage look, as well.



Allis Chalmers 20-35E 1929 & Late

with Magneto

4 Cyl. Tailored Spark Plug Wire Set

B1001-001	Original Type Cotton Braid Wire	\$25.25
B1001-001E	EPDM Wire	\$27.25

Allis Chalmers WC, WD, WD45, WF

with Distributor

4 Cyl. Tailored Spark Plug Wire Set

B1001-015	Original Type Cotton Braid Wire	\$22.75
B1001-015E	EPDM Wire	\$24.50
B1001-015S	Suppression Wire	\$24.50
B1001-015CS	Cotton Suppression Wire	\$39.00

Allis Chalmers G226 Engine

4 Cyl. Tailored Spark Plug Wire Set

B1001-021	Original Type EPDM Wire	\$24.50
B1001-021S	Suppression Wire	\$24.50

Allis Chalmers 190

6 Cyl. Tailored Spark Plug Wire Set

B1001-022	Original Type EPDM Wire	\$41.00
B1001-022S	Suppression Wire	\$41.00

BATTERY CABLES



Our Battery Cables are made from the Proper Gauge Copper, as either Black Cotton Braided Wire or PVC Wire (whichever is correct for the application), using Soldered & Heat Sealed Brass or Copper Terminals.

Allis Chalmers B, IB, C, CA

B2001-001	Negative Battery Cable	\$39.50
B2000-002	Positive Ground Strap	\$9.50

Allis Chalmers D10, D12

B2001-005	Negative Battery Cable	\$56.75
B2000-007	Positive Ground Strap	\$14.50

Allis Chalmers D14, D15

B2001-007	Negative Battery Cable	\$34.50
B2000-007	Positive Ground Strap	\$14.50

Allis Chalmers D17 Gas

B2001-009	Negative Battery Cable	\$30.75
B2000-004	Positive Ground Strap	\$10.50
B2001-010	Switch to Starter	\$25.00

Allis Chalmers D17 Diesel, D19 Diesel

B2001-011	Negative Battery Cable	\$34.50
B2001-012	Positive Battery Cable	\$39.25
B2001-013	Switch to Starter	\$31.25
B2001-014	Battery to Battery Jumper (2 Required- Each Sold Separately)	\$31.50

Allis Chalmers D19 Gas

B2001-015	Negative Battery Cable	\$23.00
B2001-016	Positive Battery Cable	\$28.50
B2001-017	Switch to Starter Cable	\$28.25

Allis Chalmers D21 Diesel

B2000-004	Negative Battery Strap	\$10.50
------------------	------------------------	---------

Allis Chalmers G

B2001-022	Negative Battery Cable	\$34.50
B2000-001	Positive Battery Strap	\$9.00

Allis Chalmers R, RC

B2001-023	Negative Battery Cable	\$39.50
B2000-002	Positive Battery Strap	\$9.50

Allis Chalmers RD

B2001-023	Negative Battery Cable	\$39.50
B2000-004	Positive Battery Strap	\$10.50

Allis Chalmers W, WC, WF

B2001-026	Negative Battery Cable	\$54.75
B2000-005	Positive Battery Strap	\$12.50

Allis Chalmers WD, WD45 (Gas)

B2001-028	Negative Battery Cable Replaces: #70,222,600	\$36.75
B2000-005	Positive Battery Strap	\$12.50

Allis Chalmers WD-45 Diesel

B2001-030	Negative Battery Cable	\$72.75
B2000-007	Positive Battery Strap	\$14.50
B2001-042	Manifold Switch To Heater Cable	\$31.25
B2001-044	Battery to Battery Jumper	\$38.75

Allis Chalmers 170 Gas

B2001-032	Negative Battery Cable	\$28.50
B2001-033	Positive Battery Cable	\$24.50
B2001-034	Switch to Starter	\$29.50

Allis Chalmers 175 Diesel

B2001-043	Positive Battery Cable	\$55.25
------------------	------------------------	---------

Allis Chalmers 180 Diesel

B2001-035	Negative Battery Cable	\$34.50
B2001-036	Positive Battery Cable	\$44.00
B2001-037	Switch to Starter	\$36.50

Allis Chalmers 190 Gas

B2001-038	Negative Battery Cable	\$26.50
B2001-039	Positive Battery Cable	\$51.50

Allis Chalmers 190 Diesel

B2001-040	Negative Battery Cable	\$39.25
B2001-041	Switch to Starter	\$31.00



WIRING HARNESSSES

Our Wire Harnesses are made with our **premium cotton braid and/or PVC wire**.

They have the **correct gauge, color, wire, & fuse holders** (if needed).

All terminals are **soldered according to the original**.

(Harnesses do not include Battery Cables & Spark Plug Wires; however, we can supply these as separate products.)

NO HIDDEN COSTS, NOTHING EXTRA TO BUY!

Allis Chalmers B, C, CA

Complete Wire Harness

B3001-001	Original Design with Generator & Cutout Relay	Replaces Allis Chalmers: #70,225,591, #225,591, #224,635, #210,949 <i>with Cutout Relay</i>	\$151.50
B3001-032	Modified for Voltage Regulator on Generator	See #B3001-001 above	\$151.50
B3001-024	Modified for 1 Wire Alternator	See #B3001-001 above	\$151.50
B3001-020	Modified for a Delco 10SI Alternator (3 Wire Alternator)	See #B3001-001 above	\$151.50

Allis Chalmers D10 Series I, II Gas (Up to Serial #9000)

Complete Wire Harness

B3001-011	Original Design with Generator	Replaces Allis Chalmers: #70231702, 231702, 70231701, 231701	\$209.50
B3001-041	Modified for 1 Wire Alternator	See #B3001-011 above	\$209.50

Allis Chalmers D12 Series I, II Gas (Up to Serial #9000)

Complete Wire Harness

B3001-011	Original Design with Generator	Replaces Allis Chalmers: #70231702, 231702, 70231701, 231701	\$209.50
B3001-041	Modified for 1 Wire Alternator	See #B3001-011 above	\$209.50

Allis Chalmers D10 Series III Gas (Serial #9001 & Up)

Complete Wire Harness

B3001-036	Original Design		\$263.25
B3001-042	Modified for 1 Wire Alternator		\$263.25

Allis Chalmers D12 Series III Gas (Serial #9001 & Up)

Complete Wire Harness

B3001-036	Original Design		\$263.25
B3001-042	Modified for 1 Wire Alternator		\$263.25

Allis Chalmers D14 Gas

Complete Wire Harness

B3001-013	Original Design	Replaces Allis Chalmers: #70228375, 702234320, 70228523	\$209.50
B3001-030	Modified for 1 Wire Alternator	See #B3001-013 above	\$209.50
B3001-038	Modified for a Delco 10SI Alternator (3 Wire Alternator)	See #B3001-013 above	\$209.50

Allis Chalmers D15 Gas Series I (Up To Serial #9,000)

Complete Wire Harness

B3001-013	Original Design	Replaces Allis Chalmers: #70228375, 702234320, 70228523	\$209.50
B3001-030	Modified for 1 Wire Alternator	See #B3001-013 above	\$209.50
B3001-038	Modified for a Delco 10SI Alternator (3 Wire Alternator)	See #B3001-013 above	\$209.50

Allis Chalmers D15 Gas Series II (Serial #9,001 & Up)

Complete Wire Harness

B3001-019	Original Design	Replaces Allis Chalmers: #70228375, 702234320, 70228523	\$209.50
B3001-027	Modified for a Delco 10SI Alternator (3 Wire Alternator)	See #B3001-019 above	\$209.50
B3001-031	Modified for a 1 Wire Alternator	See #B3001-019 above	\$209.50
B3001-037	Lighting Harness (Part of Harnesses Listed Above)		\$61.75

Allis Chalmers D17 (Series I & II) Gas (Up To Serial #41,540)

Complete Wire Harness

B3001-029	Original Design with Generator & Voltage Regulator	Replaces Allis Chalmers: #70229495, 229495, 70230195, 230195, 70229497, 229497	\$229.50
B3001-039	Modified for a Delco 10SI (3 Wire) Alternator	See #B3001-029 above	\$229.50
B3001-048	Modified for a 1 Wire Alternator	See #B3001-029 above	\$229.50

Allis Chalmers D17 Series III Gas (Serial #42,000 to 72,768)

Complete Wire Harness

B3001-040	Original Design with Generator & Voltage Regulator		\$229.50
B3001-047	Modified for a Delco 10SI (3 Wire) Alternator		\$229.50

Allis Chalmers D17 Series IV Gas

Complete Wire Harness

B3001-016	Original Design with Generator & Voltage Regulator	Replaces Allis Chalmers: #70236681, 236681, 70240175, 240175, 70228470, 228470	\$229.50
B3001-045	Modified for a 1 Wire Alternator	See #B3001-016 above	\$229.50
B3001-028	Modified for a Delco 10SI (3 Wire) Alternator	See #B3001-016 above	\$229.50

Allis Chalmers D17 Series IV Diesel (Serial #75,001 & Up)

Complete Wire Harness

B3001-017	Original Design with Generator & Voltage Regulator	Replaces Allis Chalmers: #70236681, 236681, 70240175, 240175, 70228470, 228470	\$229.50
B3001-053	Modified for a 1 Wire Alternator	See #B3001-017 above	\$229.50

Allis Chalmers D19 (Gas & LP) (Up To Serial #14,697)

Complete Wire Harness

B3001-035	Original Design with Generator & Voltage Regulator		\$229.50
------------------	--	--	-----------------

Allis Chalmers D19 Diesel (All)

Complete Wire Harness

B3001-017	Original Design with Generator & Voltage Regulator	Replaces Allis Chalmers: #70236681, 236681, 70240175, 240175, 70228470, 228470	\$229.50
B3001-053	Modified for a 1 Wire Alternator	See #B3001-017 above	\$229.50

Allis Chalmers D21 Diesel (All)

Complete Wire Harness

B3001-050	Original Design with Generator & Voltage Regulator	Replaces Allis Chalmers: Engine # 70239800, Instrument # 70240923, Main # 70248591, Lamp LH # 70248671, Lamp RH 70248672	\$748.50
B3001-055	Modified for a 1 Wire Alternator	See #B3001-050 above	\$748.50

Allis Chalmers G Tractor

Complete Wire Harness

B3001-004	Original Design with Generator & Cutout Relay	Replaces Allis Chalmers: #70,900,136, #900,136	\$103.75
B3001-043	Modified for a 1-Wire Alternator	See #B3001-004	\$103.75
B3001-033	Modified for an ND Alternator	See #B3001-004	\$103.75

Allis Chalmers I400 Gas

B3001-036	Complete Wire Harness		\$263.25
------------------	-----------------------	--	-----------------

Allis Chalmers RC, WC, WF Tractors

Complete Wire Harness

B3001-005	Original Design	Replaces Allis Chalmers: Tail Light Wire - #224,633, #70,224,633; Main Harness - #208,322, #70,208,322; Junction to Switch - #209,288, #70,209,288; Ammeter to Light Switch - #208,337, #70,208,337; Amp Meter to Starting Motor - #208,333, #70,208,333; 2-Headlight Wires - # 224,635, #70,224,635	\$145.50
B3001-034	Modified for Voltage Regulator on Generator	See #B3001-005	\$145.50
B3001-049	Modified for a 1 Wire Alternator	See #B3001-005	\$145.50

Allis Chalmers Speed Patrol (WC, WF) Tractors

B3001-054	Extension Harness , Original Design with Cutout Relay		\$56.75
B3001-052	Extension Harness , Modified for Regulator on Generator		\$56.75

Allis Chalmers WD, WD45 (Gas) Tractors

Complete Wire Harness

B3001-007	Original Design with Generator & Cutout Relay	Replaces Allis Chalmers: - #70,224,635, #70,208,635, #224,635, #208,532 Main Harness - #70,222,532, #222,532	\$151.50
B3001-044	Modified for Generator & Voltage Regulator	See # B3001-007	\$151.50
B3001-023	Modified for 1 Wire Alternator	See # B3001-007	\$151.50
B3001-026	Modified for a Delco 10SI (3 Wire) Alternator	See # B3001-007	\$151.50
B3001-051	Main Harness , Modern Type	(Part of Harnesses Listed Above)	\$75.50

Allis Chalmers WD45 Diesel Tractor

B3001-009	Complete Wire Harness	Replaces Allis Chalmers: #70227024, 227024	\$151.50
------------------	------------------------------	---	-----------------

Allis Chalmers 160

B3001-025	Complete Wire Harness	Replaces Allis Chalmers: #72073769, 72074253, 72073768, 72073770, 72073990, 72073905, 72073906	\$589.25
------------------	------------------------------	---	-----------------

Allis Chalmers 180 Diesel

B3001-046	Complete Wire Harness	Replaces Allis Chalmers: #70271808, 70249151, 70255194, 70249145, 70249150	\$596.00
------------------	------------------------------	---	-----------------

*Some Harnesses were originally made with PVC Wire & Braided; others were made with PVC Wire & Taped.
In those cases, we build them the Original Way.

TUNE UP PARTS FOR BATTERY IGNITION

Allis Chalmers CA, D10, D12, D14, D15, D17, WD, WD45, [G, WC, WF (with Delco Distributor #1111411, 1111745 & Others)]		
	B4001-001	\$4.75
	Points Replaces: #D100HP, 1855720	
	B4002-001	\$4.75
	Condenser Replaces: #1928111, D-203, 1869704, D-200	
	B4004-001	\$10.50
	Rotor Replaces: #1921285	
	B4003-001	\$13.50
	Distributor Cap Premium Grade, Made in the USA (Brass Contacts) Replaces: #811735, D300	
	B4006-001	\$9.99
	Dust Cover Replaces: #1900119	



	B4007-001	\$11.95
	Cap Clip Short Mount, 1 Used Replaces: #1889967, 1847289, 453844, 453461	
	B4007-002	\$11.95
	Cap Clip Long Mount, 1 Used Replaces: #1889967, 1889999, 453844, 453461	
	B4008-001	\$14.99
	Distributor Insulator Replaces: #1904376	
	B4009-001	\$25.99
	Distributor Bushing & Shim Kit	

*For 6- or 12-Volt Ignition Coils & Accessories, see p.44

Allis Chalmers D19 with Delco Distributor #1112615		
	B4100-001	\$10.50
	PCR Kit Includes: Points (#B4001-001), Condenser (#B4002-001), Rotor (#B4004-002) Replaces: Points - #D100HP, 1855720 Condenser - #1928111, D-203, 1869704, D-200 Rotor - #820445, D400	
	B4004-002	\$5.75
Rotor Replaces: #820445, D400		
	B4003-002	\$20.25
Distributor Cap Premium Grade, Made in the USA (Brass Contacts) Replaces: #824735, D301		
	B4006-001	\$9.99
Dust Cover Replaces: #1900119		
	B4007-001	\$11.95
Cap Clip Short Mount, 1 Used Replaces: #1889967, 1847289, 453844, 453461		
	B4007-002	\$11.95
Cap Clip Long Mount, 1 Used Replaces: #1889967, 1889999, 453844, 453461		
	B4008-001	\$14.99
Distributor Insulator Replaces: #1904376		
	B4009-001	\$25.99
Distributor Bushing & Shim Kit		

*For 6- or 12-Volt Ignition Coils & Accessories, see p.44

Allis Chalmers All Models with Continental F-163 Engine, Autolite/Prestolite Distributor #IBT-4701C		
	B4001-017	\$6.50
	Points Replaces: #IBP-2040L, IBP-3028BS, 1- 33, 147V, 1-48	
	B4002-006	\$7.50
Condenser Replaces: #2-31, 2-38, 2-42, 2-95, IAT-1125S, IAT-3076BS, IBB- 2042SS-1, IBB-2042-SS3, IG-3927F, IG- 3927G, IG-3927K, IG-3927R,		
	B4003-074	\$26.25
Cap Replaces: #3-128, IBT1111		
	B4004-012	\$7.25
Rotor Premium Grade, Made in the USA Replaces: #4-86, 4-93		

Allis Chalmers All Models with Continental F Engine & Autolite/Prestolite Distributor #IBT-6705		
	B4002-001	\$4.75
	Condenser Replaces: #1928111, D-203, 1869704, D-200	
	B4004-012	\$7.25
Rotor Premium Grade, Made in the USA Replaces: #4-86, 4-93		
	B4003-065	\$34.75
Distributor Cap Replaces: #3-127, IBT-1112, IBT- 1112B, IBT-11128		

*For 12-Volt Ignition Coils & Accessories, see p.44

Allis Chalmers All Models with Continental F Engine, Autolite/Prestolite Distributor #IBT-6701D		
	B4001-017	\$6.50
Points Replaces: #IBP-2040L, IBP-3028BS, 1-33, 147V, 1-48		
	B4002-006	\$7.50
Condenser Replaces: #2-31, 2-38, 2-42, 2-95, IAT-1125S, IAT-3076BS, IBB-2042SS-1, IBB-2042-SS3, IG-3927F, IG-3927G, IG-3927K, IG-3927R,		
	B4004-012	\$7.25
Rotor Premium Grade, Made in the USA Replaces: #4-86, 4-93		
	B4003-065	\$34.75
Distributor Cap Replaces: #3-127, IBT-1112, IBT-1112B, IBT-11128		

*For 12-Volt Ignition Coils & Accessories, see p.44

ELECTRONIC IGNITION CONVERSION KITS

Replaces Points & Condenser



Allis Chalmers B, C, CA, D10, D12, D14, D15, D17, G, WC, WD, WD45, WF with Delco Distributor #1111708, 1111411, 1111745, 1112593, & with Clip On Cap		
B9600-006	12 Volt Negative Ground	\$147.45
B9600-006P12	12 Volt Positive Ground	\$165.45
B9600-006P6	6 Volt Positive Ground	\$165.45
Allis Chalmers D19 with Delco Distributor #1112615, (Clip on Cap)		
B9600-255LS	12 Volt Negative Ground	\$162.45
B9600-255LSP12	12 Volt Positive Ground	\$175.45
Allis Chalmers 170 with Delco Distributor & Screw On Cap		
B9600-009A	12 Volt Negative Ground	\$124.95
B9600-009AP12	12 Volt Positive Ground	\$139.95

Allis Chalmers 170, 175 with Delco Distributor #1112688		
B9600-010A	12 Volt Negative Ground	\$124.95



***For Ignition Coils & Accessories, see p.44**

TUNE UP PARTS FOR MAGNETO IGNITION

Allis Chalmers Tractors with Fairbanks Morse Magneto #FMJ-4B3		
	B4110-004	\$33.95
PCR Kit Includes: Points (#B4011-002), Condenser (#B4012-001), Rotor (#B4014-001) Replaces: Points - #R2437 Condenser - #AXMR2433 Rotor - #M2765		
	B4013-001	\$49.75
Cap Replaces: #C800		
	B4013-002	\$49.75
Cap (Inner) Replaces: #A2430C		
	B4017-062	\$12.75
High Tension Rod Replaces: J983A		
	B4015-002	\$39.75
Coil Replaces: #R2477C		
	B4016-001	\$2.75
Cap Gasket (Outer) Replaces: #B682		
	B4016-002	\$2.75
Cap Gasket (Inner) Replaces: #H2498		











	B4016-003	\$14.75
	Complete Gasket Set Includes # H2498 (B4016-002), B682 (B4016-001), G2501, G3861, A2492A, Replaces: #GK17	
	B4016-005	\$1.75
	Flange Gasket Replaces: #SAE	
	B4017-049	\$93.75
	Service Repair Kit Replaces: #SK3, AXMR2433, R2437, E2460B, M2765, A5931B, 10S14D, A2492A, B682, G2501, G3861, H2498	
	B4017-001	\$2.75
	Coil Lead Replaces: #FMJL	
	B4017-036	\$14.75
	Distributor Shaft and Gear Replaces: #N5939	
B4017-058	FMJ Distributor Shaft Clip	\$2.25
B4017-059	FMJ Distributor Shaft Washer	\$2.25
B4017-060	FMJ Distributor Shaft Felt Seal	\$1.75
	B4017-037	\$21.25
	Rotor Pinion Gear Replaces: #F5952	
	B4017-002	\$11.75
	Rear Ball Bearing Replaces: #C5949	
	B4017-041	\$16.00
	Coupling Impulse Spring Replaces: #D2565	

Allis Chalmers with Fairbanks-Morse Magneto #FM-OR6B, FM-R6A, FM-XOR6A, FM-XOR6B, FM-XR6A, FM-XR6B, FM-Z6A, FM-Z6B

	B4014-017	\$36.50
	Rotor Replaces: #Z2765	
	B4013-036	\$87.50
	Cap Replaces: #Q800 Includes Cap Brush	

Allis Chalmers Tractors

with Fairbanks Morse Magneto #FMX-4B3

	B4110-005	\$39.50
	PCR Kit Includes: Points (#B4011-003), Condenser (#B4012-001), Rotor (#B4014-001) Replaces: Points - #A2437A Condenser - #AXMR2433 Rotor - #M2765	
	B4013-001	\$49.75
	Cap Replaces: #C800	
	B4013-003	\$38.75
	Cap (Inner) Replaces: #AZ2430C	
	B4015-002	\$39.75
	Coil Replaces: #R2477C	
	B4016-001	\$2.75
	Cap Gasket (Outer) Replaces: #B682	
	B4016-002	\$2.75
	Cap Gasket (Inner) Replaces: #H2498	
	B4016-003	\$14.75
	Complete Gasket Set Includes # H2498 (B4016-002), B682 (B4016-001), G2501, G3861, A2492A, Replaces: #GK17	
	B4016-005	\$1.75
	Flange Gasket Replaces: #SAE	
	B4017-038	\$80.25
	Service Repair Kit Replaces: #SK17, AXMR2433, A2437A, E2460B, M2765, A5931B, 10S14D, A2492A, B682, G2501, G3861, H2498	
	B4017-001	\$2.75
	Coil Lead Replaces: #FMJL	
	B4017-050	\$12.75
	High Tension Rod Replaces: A983A	

	B4014-009 Rotor Gear Replaces: #Y5939	\$29.75
	B4017-035 Rotor Gear (timing gear) Replaces: #Q5952	\$29.75
	B4017-002 Rear Ball Bearing Replaces: #C5949	\$11.75
	B4017-041 Coupling Impulse Spring Replaces: #D2565	\$16.00

	B4017-003 Coil Clamp 2 used, each sold separately Replaces: #94-5080	\$2.25
	B4017-004 Coil Bar Replaces: #94-5066	\$8.50
	B4017-005 Inner Bearing Replaces: #24-5000	\$3.50
	B4017-006 Outer Bearing Replaces: #25-5000	\$9.75
	B4017-046 Bearing Cage Snap Ring Replaces: #43-5055	\$2.75
	B4017-007 Impulse Spring Replaces: #94-5016	\$12.50
	B4017-008 Stop Button Assembly Includes #B4017-009 Replaces: #90-5042 For the version with a Ground Wire, use #B4017-063 (\$7.26) instead.	\$6.25
	B4017-051 WICO Impulse Catch Plate Replaces: #94-5070, FXH-210S-1	\$10.25
	B4017-009 Stop Button Replaces: #94-5079	\$2.25
	B4016-005 Flange Gasket Replaces: #SAE	\$1.75
	B4016-012 Striker Plate Gasket Replaces: #94-5154	\$2.25
	B9013-011 WICO Series X Nameplate Fits the WICO Series X magneto (Rivets included)	\$7.00

Allis Chalmers Tractors with WICO Magnetos #XH184, XH894, XH1023, XH1714, XHD3200		
	B4011-004 Points Replaces: #1-5008, 1-5111, FXH-2100B, FXH-2400B, X5996	\$17.75
	B4012-002 Condenser Replaces: #2-5007, X5614, X6916	\$13.75
	B4017-040 Condenser Clamp Replaces: #94-5167	\$2.75
	B4013-004 Cap Includes #B4016-004 Replaces: #3-5014	\$36.75
	B4014-002 Rotor Replaces: #4-5010	\$23.50
	B4016-004 Cap Gasket Replaces: #94-5076	\$2.25
	B4015-003 Coil (Hot Coil) Replaces: #5-5011, AR12006, FXH2403, X5700, X5700B, X5700C	\$39.75

REPLACEMENT MAGNETOS

Rebuilt Magnetos

Our Rebuilt Magnetos are completely torn down, cleaned, & inspected. They will (at the minimum) have the following new parts: Points, Condenser, Coil, Coil Insulators, Lead-out Tower, & Outside Covers, plus any additional parts that are needed to make the unit look & perform like new.

They come with a 1-Year Limited Warranty.

Notes:

1. Unless otherwise specified, cost is exchange price.
2. A core charge (see below) will be charged to your credit card until we receive your good core.
3. A good core is considered a complete magneto with no cracks or weld repairs. Only good cores will be credited.

Magnetos must be used with copper ignition wire. Use of any other type will Void the Warranty.

FMJ4B3R	Exchange	\$475.00
	Outright	\$625.00
	Rebuilt Fairbanks Morse FMJ-4B3 Magneto 4 Cyl. Flange Mount Allis Chalmers Fits: B, C, CA, R, WC, WD, WD45, WF Core Charge: \$150.00	
FMX4B3R	Exchange	\$475.00
	Outright	\$725.00
	Rebuilt Original Fairbanks Morse FMX4B3 Magneto 4 Cyl. Flange Mount Fits: Allis Chalmers – B, B15, BE, C, CE, R, RC, W, WC, WD, WF, W2 Core Charge: \$250.00	

	XH184R	Exchange	\$445.00
		Outright	\$645.00
Rebuilt WICO Magneto 4 Cyl. Base Mount Core Charge: \$200.00			
	XH894R	Exchange	\$445.00
		Outright	\$645.00
Rebuilt WICO Magneto 4 Cyl. Flange Mount Allis Chalmers Replaces: Fairbank Morse FMJ-4B3 Fits: B, C, CA, R, WC, WD, WD45, WF Core Charge: \$200.00			

GAUGES

Ammeters, Universal

B9025-002	Ammeter 20-0-20	\$19.99
	Has a chrome bezel. Allis Chalmers Fits: B, C, CA, G, IB, RC, WC, WD, WD45, WD45 (Diesel), WF Replaces: #208302, 70208302	
B9025-005	Ammeter 30-0-30	\$19.99
	Has a chrome bezel. Allis Chalmers Fits: 190XT, B, C, CA, D10, D12, D14, D15, D17, D19, D21, H3, HD3, I40, I400, I60, I600, WC WD, WD45, WF, 170, 175, 180, 185, 190 Replaces: 70254407, 240987, 254407, 70240987	
B9025-008	Ammeter 60-0-60	\$19.99
	Has a black face with white lettering & a chrome bezel Uses threaded terminals and is dash mounted Used with 12-Volt Alternator Systems Dimensions: Fits in 2" Diameter Hole Measures 1.765" from Top of Post to Bottom of Bezel	

Ammeters, Allis Chalmers

B9025-012	Ammeter 30-0-30	\$29.99
	Includes the Allis Chalmers logo. Fits 2" diameter hole Allis Chalmers Replaces: 70240987, 70254407, 220987, 70228717, 70208302, 228717, 240987, 254407, 208302 Fits Models: 190XT, 190XT (Series III), 4W220, B, C, CA, D10, D12, D14, D15, D17, D19, D21, G, H3, HD3, RC, WC, WD, WD45 (Diesel), WD45, WF, 170, 175, 180, 185, 190, 200, 210, 220	

Oil Pressure Gauges, Universal

B9025-004	Universal Oil Pressure Gauge (0-50 PSI)	\$21.99
	Has 1/8" NPT Male Threads, studs, & a bracket. No logo included, has a black face with white letters & chrome bezel. Dash-mounted, requires 2" diameter hole. Allis Chalmers Replaces: 228719 Fits: D10, D12, D14, D15, D17 (Series I & II), H3, I40, I400, I60, I600, WD45 (Diesel)	

B9025-001	Universal Oil Pressure Gauge (0-80 PSI)	\$24.99
	Has 1/8" NPT Male Threads, studs, & a bracket. No logo included, has a black face with white letters & chrome bezel. Dash-mounted, requires 2" diameter hole. Allis Chalmers Replaces: 228719, 70228719 Fits: 190XT, D19, D21, 170, 175, 180, 185, 190, 210, 220, D15, D17, WD45 WD45D, U, UC (To Sn: 51344)	

Oil Pressure Gauges, Allis Chalmers

B9025-011	Allis Chalmers Oil Pressure Gauge (0-30PSI)	\$32.99
	Includes Allis Chalmers logo on face of Gauge, chrome bezel, engine mounted (0-30 PSI) 1/8"NPT Male Thread Allis Chalmers Replaces: U3805, 70203805, 70207834, 207834 Fits Models: B, C, CA, G, IB, RC, [U, UC (with Engine Mounted Oil Pressure Gauge & SN: 15345 & up)], WC, WD, WD45, WF	

B9025-063	Allis Chalmers Oil Pressure Gauge (0-45PSI)	\$32.99
	Restoration Quality Oil Pressure Gauge includes a bracket and mounting washers & nuts. Has a white face with black lettering, a chrome bezel, & Allis Chalmers logo. Fits 2" Diameter Holes. 1/8" Pipe Thread. Allis Chalmers Replaces: #228719, 70228718, 70228719 Fits: D10, D12, D14, D15, D17, I40, I400, I60 (Gas & LP Only)	

Oil Pressure Gauge, Line Kit

B9026-001	Oil Pressure Gauge Line Kit	\$29.99
	6 FT copper 1/8" line --- Kit includes: (2) 5/16 - 24 UNF nut, (2) compression sleeves, (1) 1/8 - 27 NPTF female to 5/16" - 24 UNF male adapter. Note: Depending on application customer may be required to purchase other fittings.	

B9026-004	Oil Pressure Gauge 1/4" to 1/8" NPT Adapter Fitting	\$15.99
	Adapter Fitting for Oil Gauges Allis Chalmers Fits (1/4" tubing only): A, [D10, D12, D14, D15, D17, D19 (Using Mechanical Gauge)]	

Water Temperature Gauges, Universal

B9025-006	Water Temperature Gauge	\$34.99
	Includes an Aluminum Sealing Washer to Seal Probe. Has a Chrome Bezel with White, Green, Red Zones on a Black Gauge Face. 1/2" NPT Pipe Bushing and Probe Length of 1.279". Allis Chalmers Fits: D10, D12, D14, D15, D17, H3, H4, HD3, HD4, I40, I400, I60, I600 (And Other Models Using 60" Capillary Lead)	

B9025-007	Universal Water Temperature Gauge	\$34.99
	Dash-mounted (parts included), 72" long heavy duty capillary tube included (check length before ordering) Allis Chalmers Fits: [D10, D12, D14, H3, H4, HD3, HD4, I40, I400 (And Others Using 72" Or Shorter Capillary Lead)], [D15, D17, D19, I60, I600 (Gas, Diesel, And Others Using 72" Or Shorter Capillary Lead)], WD45 (Diesel, And Others Using 72" Or Shorter Capillary Lead)	

Water Temperature Gauges, Allis Chalmers

B9025-009	Allis Chalmers Water Temperature Gauge	\$29.99
	Has a white face & includes the Allis Chalmers logo. Threads into the radiator neck. Brass stem length is 2.048". Measures 2.765" from the top of the nut to the end of the stem with a .373" stem diameter & 4" of overall length Allis Chalmers Replaces: 70213675, 213675 Fits Models: B, C, CA, IB, RC, WC, WD, WD45, WF	

B9025-013	Allis Chalmers Water Temperature Gauge	\$49.99
	<p>This Allis Chalmers Gauge has the Allis Chalmers logo on a White Face with White, Green, and Red Zones with a Normal Operation (Green) Range Between 160° to 220° F. Fits in a 2" Diameter Hole. 5/8" – 18 U.F. End with 1/2" NPT Pipe Bushing. Has a 72" Capillary Lead. Probe length is 1.496".</p> <p>Allis Chalmers Replaces: 226966, 228334, 229870, 231378, 235724, 70235724 Fits: D10, D12, D14, [D15, D17 (Gas/Diesel)], WD45 (Diesel)</p>	

Traction Booster Gauge

B9025-010	Allis Chalmers Traction Booster Gauge	\$108.99
	<p><i>This Gauge Is A Fully Functioning Gauge.</i> (Traction Booster Gauges That Were For Looks Only Have Been On The Market For Many Years Now.) Has 1/4" Male Flare End</p> <p>Allis Chalmers Replaces: 70228977, 70235598, 70226631, 235598, 228977, 226631 Fits: CA, D10 (Up to SN: 9199), D12 (up to SN: 9167), D14, D15 (up to SN: 9000) D17 (up to SN: 75000), D19 WD WD45</p>	

Tachometer Drive Cable

B9026-003	56" Tachometer Drive Cable	\$34.99
	<p>Restoration Quality. Drive Cable for Tachometers. Measures 56" Outer Sheath Length. 5/8"-18 x 7/8"-18 Threads With Key On One End. Please Check Length Before Ordering.</p> <p>Allis Chalmers Replaces: #229751, 233639, 244107, 261607, 261609, 70229751, 70233639, 70244107, 70261607, 70261608 Fits: D15 (Diesel), D17 (Gas), [D21, 190, 190XT (Diesel, with Camshaft Driven Tachometer)]</p>	

B9026-012	Tachometer Cable, 61 1/4"	\$36.99
	<p>61 1/4" Inner Cable Length with Squared Ends, 5/8 – 18 x 7/8 - 18 threads, Metal Sheath</p> <p>Allis Chalmers Replaces: #237076, 261605, 70237076, 70261605 Fits: D19</p>	

SWITCHES

B5011-002	Light Switch Resistor	\$15.99
	<p>Used on all Models with Cut Out Relay & Original Delco 4 Position Light Switch</p> <p>Fits: Allis Chalmers - B, IB, C, CA, G, RC, WC, WF, WD, WD45 Up to Serial #201,241 Replaces: Delco - #1838155, 1882994, 1878070</p>	

Push/Pull Switches

B5002-001	2 Position Push/Pull Switch	\$7.75
	<p>OFF/ON Universal 2 Position Push/Pull (2 Screw Terminals) Mounting Stem 3/8"-32 Thread Knob #10/32 Thread</p>	

B5002-002	2 Position Push/Pull Switch	\$11.75
	<p>Universal 2 Position Push/Pull Switch (2 Screw Terminals) Mounting Stem 1/2"-20 Thread Knob #10/32 Thread</p>	

B5002-015	1-Terminal Push-Pull Magneto Ignition Switch (OEM)	\$23.99
	<p>Replaces Allis Chalmers – #213140, 70213140</p>	

B5002-004	Heavy Duty Push/Pull Magneto Switch	\$8.25
	<p>ON/OFF (2 Position) Push/Pull Magneto Switch (2 Screw Terminals) Mounting Stem 3/8"-32 Thread Knob #10/32 Thread Allis Chalmers Replaces: #213140, 70213140</p>	

B5002-005	3-Position Push/ Pull Switch	\$29.75
	<p>Low Charge/High Charge/Lights (3 Position Switch) 3 Screw Type Mounting Stem .8" Thread Knob #10/32 Thread Premium Quality Made by an OEM Manufacturer Allis Chalmers Replaces: #208197, 70208197 Fits: [B, C, CA, G, WC, WD, WD45 (With Cut Out On Generator)], RC, WF;</p>	

Key Switches

B5003-001	2 Position Battery Key Switch	\$14.75
	<p>Universal OFF/ON 2 Position Key Switch (For Battery Ignition) (2 Screw Terminals) Mounting Stem 3/4"-20 Thread</p>	

B5003-005	4 Position Ignition Key Switch	\$39.99
	Can replace the 4 terminal switch. 2 battery terminals, 5 Spade Terminals, OEM Style Delco Remy 995" Diameter Threaded End. Includes 2 Keys & Jam Nut Allis Chalmers Replaces: #235785, 70235785, 229201, 234356, 233320, 231705, 230163	
Fits: D10 (Up to SN: 3500), D12 (Up to SN: 3000)- will also fit later serial numbers, but must use 70227195 washer so will fit the dash (washer not available). For SN: 9001 & up, use #B5003-007. D14 (SN: 9500 & up), D15 (Up to SN: 9000, using Delco switch), D17 (Up to SN: 75000), D19, D21, [H3, HD3 (early, Using Delco Switch)]		

B5003-006	Ignition Key	\$4.99
	Key For Above Part, #B5003-005. Brass Finish Fits Listed Models Using Delco Switch Allis Chalmers Replaces: 231713, 70231713, 72162639 Fits: [D10, D12 (To Sn: 9000)], D14 (SN: 9500 & up), D15 (Up to SN: 9000), D17 (Up to SN: 75000), D19, D21, [H3, HD3 (Early, Using Delco Style Switch)]	

B5003-007	3 Position Ignition Key Switch	\$27.99
	OEM Switch. 5 Spade Terminals, Drain Hole, 9/16"-24 Threaded Mounting Stem. Includes: 2 Keys, 1 Jam Nut, 1 Internal Washer Allis Chalmers Replaces: #233759, 241965, 70233759, 70241965 Fits: [D10, D12 (Late, SN #9001 & Up)], D15 (Late Model, Gas/Diesel SN #9001 & up using an Indak switch), D17 (SN #75001 & Up), [H3, HD3 (Late, Using Indak Switch)], H4, HD4, I40, I400, [I500, I60, I600, 510, 512, 610, 612, 614, 621 (Gas / Dsl)], 170, 175, 180, 185, 190, 190XT, 200, 210, 220	

B5003-027	Indak Style Key (for switch above)	\$4.99
------------------	---	---------------

B5003-008	Ignition Key Switch	\$24.99
	Includes 2 Keys, 2 Spade Terminals Designed for 0.800" hole diameter. Allis Chalmers Fits: B, C, CA, D14, WD, WD45	

Momentary Switches

B5004-003	Momentary Push Switch	\$15.75
	Manual Push Button Solenoid Switch with Rubber Protected Cap (2 Screw Terminals) Mounting Stem 5/8"-32 Thread Allis Chalmers - Replaces: #70253322, 71191589, 227029, 245936, 72160068, 242988, 245866, 253322, 240962	
Fits: AC Combines (Ether Switch): F, F2, F3, K, K2, L, L2, L3, M, M2, N5, N6, N7, R40, R60, R70 AGCO Tractor (Ether Switch): 4660, 5670, 5680, 6150 Allis Chalmers : [190XT, D15, D17, D19, 170, 175, 180, 185, 190, 200, 210, 220, 7010, 7020, 7045, 7080, 7580, 8550 (Starter Switch)], [4W220, 4W305, 8010, 8030, 8050, 8070 (Ether Switch)], [D21, 7030, 7040, 7050 (Starter Switch & Ether Switch)], 7000 (Starter Switch SN: 4095 & up & Ether Switch on all), 7060 (Starter switch on all Except PD and PS tractors);		

B5004-007	Neutral Safety Switch	\$29.99
	Manual Push Button Safety Switch used as a Neutral Safety Switch. 2 Spade Terminals. 5/8"-32 Thread. 2.575" Total Length. Allis Chalmers Replaces: #2122233SM, 248659, 5021522YP, 70248659	
Fits: 160, 170, 175, 180, 185, 190, 190XT, 200, 210, 220, 440, 4W220, 4W305, 5040, 5045, 5050, 6040, 6060, 6070, 6080, 7000, 7010, 7020, 7030, 7040, 7045, 7050, 7060, 7080, 7580, 8010, 8030, 8050, 8070, 8550		

Light Switches

B5010-017	Rotary Light Switch w/ Knob	\$39.99
	OEM Light Switch. 11/16"-28 UN Threaded Stem. 4 Position. Allis Chalmers Replaces: #249142, 70249142 Fits: 160, 170, 175, 180, 185, 190, 190XT (Serial #19001 & Up), 200, 210, 220, 6040	

B5011-005	Light Switch Plate	\$17.99
	Light Switch Plate. OFF/LOW/HIGH/FLOOD Positions. Allis Chalmers Replaces: #249141, 70249141 Fits: 160, 170, 175, 180, 185, 190, 190XT, 200, 210, 220, 6040	

CUTOUT RELAYS & VOLTAGE REGULATORS

Note: Due to modern battery design, voltage regulators can't be used to charge low or dead batteries. Doing so will destroy the voltage regulator and void the warranty.

B8001-001	6-Volt Cutout Relay	\$19.50
	15 Amps, 6 Volt Works Positive or Negative Ground Replaces: Autolite - CB4014, C4012(9-5), C4012(9-4), C4012(9-1), R40061 Delco - #266P, 266N, 265P, 265N, 5015850, 812970, 265J, 820845, 812971, 1116816, 265G, 265H, 1116755, 1116751, 1116809DR, 265B, 1842859, 265C, 1867781, 265F, 265D	
Fits: Allis Chalmers - B, C, CA, IB, IU, M, RC, U, UC, WC, WD, WD45, WF		

B8001-002	Electronic Cutout Relay	\$19.50
	25 Amp, Works with 6, 12, or 24 Volts. & Positive/Negative Ground Replaces: Autolite - #CB4014, C4012 (9-5), C4012 (9-4), C4012 (9-1), R40061 Delco - #266P, 266N, 265P, 265N, 5015850, 812970, 265J, 820845, 812971, 1116816, 265G, 265H, 1116755, 1116751, 1116809DR, 265B, 1842859, 265C, 1867781, 265F, 265D	
Fits: Allis Chalmers - B, C, CA, IB, IU, M, RC, U, UC, WC, WD, WD45, WF		

6-Volt Saddle Mounted Cutout Relay (Delco Version)		
B8001-004	Premium Quality, Made in the USA	\$122.50
B8001-006	Standard Quality	\$38.59
	Cutout Relay, 25 Amp, 6 Volt, Works Positive or Negative Ground. Replaces: Delco - #266P, 266N, 265P, 265N, 5015850, 812970, 265J, 820845, 812971, 1116816, 265G, 265H, 1116755, 1116751, 1116809DR, 265B, 1842859, 265C, 1867781, 265F, 265D Fits: Allis Chalmers - B, C, CA, IB, IU, M, RC, U, UC, WC, WD, WD45, WF	

12-Volt Delco Type Voltage Regulator		
B8002-017	Premium Quality, Made in the USA	\$99.75
B8002-018	Standard Quality	\$34.75
	12 Volt, 4 Terminals, Flat Mounting Bracket Regulator, Tractor Mounted Replaces: Delco - 1118381, 1118779, 1118977, 1118987, 1118993, 1118997, 1118999, 1119576, D646 Prestolite - 8-290 Fits: Allis Chalmers - D15 (12-Volt), D17 Diesel, D19 Gas (up to Serial #14697)	

12-Volt Delco Type Voltage Regulator		
B8002-019	Premium Quality, Made in the USA	\$116.51
B8002-020	Standard Quality	\$34.75
	12 Volt, Generator Mounted Delco Voltage Regulator Replaces: Delco - 1118792, 1118991, D649 Prestolite - 8-295, GRX-408 Fits: Allis Chalmers - D17	

B8002-006	12-Volt Voltage Regulator	\$67.50
	12 Volt, 3 Terminal, Negative Ground, Voltage Regulator Premium Quality/ USA Made Replaces: Delco - #1119673, 1118219, 1118241, 1118245, 1118252, 1118261, 1118263, 1118264, 1118267, 1118285, 1118317, 1118318, 1118325, 1118328, 1118329, 1118358, 1118367, 1118370, 1118384, 1118385, 1118704, 1118709, 1118716, 1118734, 1118736, 1118749, 1118750, 1118754, 1118759, 1118761, 1118825, 1118826, 1118839, 1118840, 1118882, 1118891, 1118892, 1118893, 1118894, 1118895, 1118896, 1118898, 1118899, 1118900, 1118931, 1118932, 1118933, 1118934, 1118935, 1118936, 1118945, 1118953, 1118967, 1118968, 1118974, 1119000, 1119001, 1119002, 1119003, 1119020, 1119122, 1119123, 1119150, 1119151, 1119155, 1119158, 1119161, 1119162, 1119174, 1119181, 1119182, 1119183, 1119190, 1119192, 1119205, 1119220, 1119234, 1119235, 1119238, 1119239, 1119242, 1119244, 1119247, 1119253, 1119260, 1119261, 1119263, 1119264, 1119277, 1119278, 1119279, 1119280, 1119299, 1119612, 1119621, 1119624, 1119634, 1119641, 1119642, 1119644, 1119645, 1119649, 1119657, 1119663, D617, D618, D620, D626, D611 Fits: Allis Chalmers D19 Gas Serial #14698 & Up	

B8002-038	24-Volt Delco Voltage Regulator	\$119.75
	*Call for Availability* 24 Volt, 4 Terminal, Flat Mounting Premium Quality, Made in the USA Replaces: Delco - #1118737, 1118799, 1119185 Fits: Allis Chalmers - All w/ Delco Generator #1106867	

B8002-029	Regulator Shock Mount Kit	\$23.95
	Used in Conjunction with #B8002-006, B8002-038 Delco Type Voltage Regulator Replaces: Delco # 1910966, 1911028, 1911034, 1914863, 1915331, D32596 JD # AR11041, AR11042, AT21632	

ALTERNATOR VOLTAGE REGULATORS

B8002-030	Alternator Voltage Regulator	\$14.50
	Heavy Duty, 12 Volt, Negative Ground Alternator Voltage Regulator. External voltage regulator, has 4 spade terminals (field, 2, 3, 4). Designed for 'B' type circuits. For Delco 10DN, & 20DN Replaces: Allis Chalmers - #72072955, 243986, 70243986, 0245330-6, 0255864-1, 9004846-3, 9004867-9 Delco - #D630, D635, D663, 1119513, 1119515, 1119508, 1119519, D663, 1119502, 1119516, 1119506, 1119512, 1119515 Fits: Allis Chalmers - [190XT, 170, 175, 180, 185, 190 (Gas, Diesel), [D21, 160, 200, 210, 220 (With Factory Alternator)	

GENERATOR BEARING & BRUSH SETS

10181RK	6 Volt, 3 Brush Generator Repair Kit	\$14.75
	Includes 3 Brushes, 1 Ball Bearing & 1 Bushing. 6 Volt. Allis Chalmers B, C, CA, R, WC, WD, WD-45, WF Fits: Delco Generator #1101355 & 1101423	

10341RK	12 Volt, 2 Brush Generator Repair Kit	\$11.75
	Includes 2 Brushes, 1 Ball Bearing & 1 Bushing. Allis Chalmers D10, D12, D14, D15, D17 Gas & Diesel, D19 Gas & Diesel, D21 Gas & Diesel with 12 Volt Generator Fits: Delco Generator #1100027	

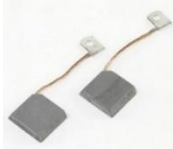
X270	12 Volt, Brush Set	\$5.00
		Allis Chalmers Fits: D17 Diesel 12 Volt, with Tractor or Generator Mounted Regulator

STARTER BRUSH SETS & STARTER BEARINGS

4017RK	6 Volt Starter Repair Kit	\$11.75
		Includes 2 Bushings & 4 Brushes Fits 6 Volt Delco Starter #1107043 Allis Chalmers - B, C, CA

STARTER SWITCHES & SOLENOIDS

B5006-003	Saddle Mount Lever Switch	\$11.75
		Lever or Rod operated, 6 or 12 Volt, Starter Mounted, Manual Push Button Starter Switch Has Bracket for Rocker Lever Replaces: Allis Chalmers - #226128 Delco - #1872403, 1872405, 1882323, 1918405, 1919576, 1919600, 1925781, 1918405, 1919578, 1919600, 1923480, 1925781, 1932131, 1940047, D903, D904, D905, D908, D909 Fits (with Delco Starter): Allis Chalmers - B, IB, C, CA, G, RC, WC, WD, WD45 GAS, WF

4020RK	6 Volt Starter Repair Kit	\$11.75
		Includes 2 Bushings & 4 Brushes Fits: Delco Starter #1107051 Allis Chalmers - WD, WD-45

B5011-008	Delco Starter Switch Lever	\$8.99
		For use in "PUSH" rod starter switch systems. Allis Chalmers Replaces: #209313, 210172, 70209313, 70210172, 1878153 Fits: B (up to Serial #113778), C, IB (up to Serial #1878), RC, WC (Serial #74330 & up), WF (Serial #1904 & up)

4364RK	6 Volt Starter Repair Kit	\$11.75
		Includes 2 Bushings & 4 Brushes Fits 6 Volt Delco Starter #1107951 Allis Chalmers - WD, WD45

IDENTIFICATION TAGS

B5007-001	6 Volt Solenoid	\$17.50
		3 Terminal Solenoid with Curved Bracket Fits: Allis Chalmers - B, C, CA

B9013-001	Small Autolite I.D. Tag (Blank)	\$7.00
	Small Autolite I.D. Tag (Stamped)	\$14.25
		2 5/16" Long, Black I.D. Tag for Distributors, Starters, & Generators with Rivets

B5007-004	12 Volt Solenoid	\$23.75
		Has a Curved Bracket & 4 Terminals (Used with 30 & 35 MT Delco Starters) Replaces: Delco : #1119890, 1119912, 1119885, 1119877, 1119935, 1119882, 1119906, D953, D985, 1119833, 1119883, 1115537, 1119978, 1115582, 1119778, 1115508, 1115529, 1115540, 1115501 Allis Chalmers - #231264, 243828, 231835, 70243828, 79017977 Fits: Allis Chalmers - 180, 185, 190, 190XT, 200, 7000, 7010, 7020, 8010 Diesel (all with Delco Starter #1113657) D17 Diesel, up to SN: 38964 (with Starter 1113082); including some F, G, & M series diesel combines

B9013-002	Large Autolite I.D. Tag (Blank)	\$7.00
	Large Autolite I.D. Tag (Stamped)	\$14.25
		2 15/16" Long, Black I.D. Tag for Distributors, Starters, & Generators with Rivets



Delco Remy

B5007-015	12 Volt Solenoid for Lucas M50 Starters	\$34.25
		12 Volt Rated Solenoid with 4 Terminals and Mounted to Lucas M50 Direct Drive Starters. Replaces: Lucas - #60933087, 76906, 76937, 77123, 77123A, TOB118, TPB100 Allis Chalmers - #256898, 256948, 70273901 Fits: Allis Chalmers - 180, 185, 200, 6060, 6080, 8010

B9013-004	Delco Remy I.D. Tag (Blank)	\$7.00
	Delco Remy I.D. Tag (Stamped)	\$14.25
		Black Delco-Remy I.D. Tag for Distributors, 6 Volt Starters, & 6 Volt Generators with Rivets, 3/4" 2 5/16"

B9013-005	Red Delco Remy I.D. Tag (Blank)	\$7.00
	Red Delco Remy I.D. Tag (Stamped)	\$14.25
		Red Delco-Remy I.D. Tag for 12 Volt Starters & 12 Volt Generators with Rivets, 3/4" 2 5/16"
B9013-013	Delco Remy I.D. Tag (Blank)	\$7.00
	Delco Remy I.D. Tag (Stamped)	\$14.25
		Black Delco-Remy I.D. Tag for Distributors, 6 Volt Starters, & 6 Volt Generators with Rivets, 3/4" 2 5/16"

ALTERNATOR BRACKETS

B9014-006	Allis Chalmers Alternator Bracket Kit	\$55.99
		Alternator bracket kit for conversion from generator to alternator. Made in the USA. Allis Chalmers Fits: B, C, CA, IB
B9014-007	Allis Chalmers Alternator Bracket Kit	\$66.99
		Alternator bracket kit for conversion from generator to alternator. Made in the USA. Allis Chalmers Fits: WC, WD, WD45, WF

ALTERNATORS

Delco 10SI Type





B6001-001	12 Volt Alternator (1 Wire)	\$112.75
63 Amp, Low Cut In, Specially Built For Tractors, Forklifts, & Other Low Engine Speed Applications		
B6001-002	12 Volt Alternator (1 Wire/ 3 Wire)	\$118.75
63 Amp, With 1 Wire Or 3 Wire For Warning Lamp On Automobiles & Trucks		
B6001-005	6 Volt Alternator (1 Wire, Positive Ground)	\$166.50
6 Volt, 40 Amp Alternator with Positive Ground, 1 Wire, 3/8" pulley		
B6001-011	12 Volt Alternator (1 Wire)	\$129.75
12 Volt, 63 Amp Alternator with Negative Ground, 1 Wire with Mechanical Tachometer Drive.		
B6001-013	12 Volt Alternator (1 Wire), 5/8" to 3/4" Pulley	\$113.75
12-Volt, 1-Wire Alternator (Self-Exciting), 63 Amp, Negative Ground), 5/8" to 3/4" Pulley		

Small ND Type

B6002-003	12 Volt Small Denso Alternator (1-Wire)	\$119.75
		40 Amp, 1 Wire Internal Regulator. Will Start Charging with a Much Lower Engine Speed. Comes with a 4 1/2" Housing Diameter, 3/8 To 1/2" Belt width & a 2 1/2" Pulley Diameter. Excellent for Converting a 6 Volt System to 12 Volt. Negative Ground Only & is Self-Excited

LIGHTS & LIGHT PARTS

Headlight Assembly		
B9016-040	Bullet Type 6 Volt Head	\$53.99
B9016-041	Bullet Type 12 Volt Head	\$53.99
		Allis Chalmers Replaces: #208,233, & #237,100 Fits: RC, WC (Serial #74,330 & Up), WF (Serial #1904 & Up)
PARTS FOR LIGHT ABOVE		
B9017-056	4 3/4" Lens with Guide Name	\$14.99
B9017-057	4 3/4" Clamp Ring (Black)	\$15.99
B9017-058	4 3/4" Gasket	\$3.99
B9017-004	4 3/4" Reflector	\$14.99
B9017-067	4 3/4" Light Terminal	\$6.00
B9017-013	6 Volt Bulb	\$3.00
	Pack of 10	\$25.50
B9017-015	12 Volt Bulb	\$3.00
	Pack of 10	\$25.50

Bullet Type Head Lamp		
B9016-007	Bullet Type 6 Volt Head	\$49.99
B9016-048	Bullet Type 12 Volt Head	\$54.99
		6 or 12 Volt Head, & clear rear lamp (can be used as 12 volt by changing bulb) Allis Chalmers Replaces: #210,921 & 210,922 Fits: B, C, CA, D10, D12, D14, D15 (Up To Serial #9,001)

PARTS FOR LIGHT ABOVE		
B9017-056	4 3/4" Lens with Guide Name	\$14.99
B9017-057	4 3/4" Clamp Ring (Black)	\$15.99
B9017-058	4 3/4" Gasket	\$3.99
B9017-004	4 3/4" Reflector	\$14.99
B9017-067	4 3/4" Light Terminal	\$6.00
B9017-013	6 Volt Bulb	\$3.00
	Pack of 10	\$25.50
B9017-015	12 Volt Bulb	\$3.00
	Pack of 10	\$25.50

B9016-062	12V Headlight Assembly	\$49.99
	12 Volt 5 3/4" Headlight. Stamped: TRACT-O-LITE on housing. Allis Chalmers Replaces: #229915 Fits: Crawler H3, [Serviceable: D10, D12 (Serial #9001 & Up), D15, D17 (Gas Up to Serial #42001), D19]	

PARTS FOR LIGHT ABOVE		
B9017-033	Sealed Beam, 12 Volt Bulb	\$14.75
	Double Contact High Beam 35 Watts with a 5.625" Outside Diameter Replaces bulb #4419	

B9016-006	Bullet Type Head Lamp	\$57.99
	6 Volt Head, & clear rear lamp (can be used as 12 volt by changing bulb) Allis Chalmers Replaces: 236969, 70236969 Fits: RC, WC, WD, WD45, WF	

PARTS FOR LIGHT ABOVE		
B9017-056	4 3/4" Lens with Guide Name	\$14.99
B9017-057	4 3/4" Clamp Ring (Black)	\$15.99
B9017-058	4 3/4" Gasket	\$3.99
B9017-004	4 3/4" Reflector	\$14.99
B9017-067	4 3/4" Light Terminal	\$6.00
B9017-013	6 Volt Bulb	\$3.00
	Pack of 10	\$25.50
B9017-015	12 Volt Bulb	\$3.00
	Pack of 10	\$25.50

Did You Know?
From the years 1919-1922, the famed inventor Nikola Tesla worked for Allis-Chalmers in Milwaukee.

Sealed Beam Head Lamps for Flat Top Fenders		
B9016-036	(Low Beam)	\$54.99
B9016-037	(High Beam)	\$54.99
	12 Volt Low/High Beam Head Lamps Allis Chalmers Replaces: 249146 (Low Beam), 249147 (High Beam) Fits: 170, 175, 180, 185, 190, 190XT, 200, 210, 220 with Flat Top Fenders	

PARTS FOR LIGHT ABOVE		
B9017-031	Sealed Beam, 12 Volt High Beam	\$18.99
B9017-032	Sealed Beam, 12 Volt Low Beam	\$16.50
	4 1/2" diameter Allis Chalmers - 200, 6040, 6060, 6080, 7000, 7010, 7020, 7030, 7040, 7045, 7050, 7060, 7080, & Will also Fit 170, 175, 180, 185, 190XT But not original look!	
	B9017-009	\$5.99
	Concave Light Mounting Washer/Retainer	

Sealed Beam Head Lamp Assembly for Tractors with Flat Top Fender Lighting		
B9016-022	12 Volt Low Beam	\$39.99
B9016-023	12 Volt High Beam	\$59.75
B9016-080	12 Volt LED Trapezoid	\$67.99
B9016-081	12 Volt LED Flood Light	\$67.99
	Allis Chalmers Replaces: #267185, 70267185 Fits: 160, 6060, 6080, 7000, 7010, 7020, 7030, 7040, 7045, 7050, 7060, 7080 (Not like original) – 170, 175, 180, 185, 190, 190XT, 200	

PARTS FOR LIGHT ABOVE		
B9017-031	Sealed Beam, 12 Volt High Beam	\$18.99
B9017-032	Sealed Beam, 12 Volt Low Beam	\$16.50
	4 1/2" diameter Allis Chalmers - 200, 6040, 6060, 6080, 7000, 7010, 7020, 7030, 7040, 7045, 7050, 7060, 7080, & Will also Fit 170, 175, 180, 185, 190XT But not original look!	
	B9017-009	\$5.99
	Concave Light Mounting Washer/Retainer	

B9016-075	12 Volt Sealed Beam Combo Tail Light Assembly	\$116.95
	4 3/4" diameter Allis Chalmers Replaces: 233318, 235412, 237402, 240895, 241596, 243313, 70237402, 70240895, 70241596, 70243313 Fits: D10, D12, [D15 SN: 9001 & Up], [D17 SN: 42001 & up], D19, D21, [190, 190XT Up to SN: 19000]	

B9016-054	Round Fender & Cab Mount Warning Light	\$19.99
	Restoration Quality 12 Volt Round Light with 2 x 4" Diameter Amber Lenses, Double Contact Bulb, 1/2" Diameter Stud, & 2.4" Thick at Widest Point. Allis Chalmers Replaces: #248110, 249139, 70248110 Fits: D21, 160, 170, 175, 180, 185, 190, 190XT, 200, 210, 220, 440, 5040, 5045, 5050, 6040, 6060, 6070, 6080, 7000, 7010, 7020, 7030, 7040, 7045, 7050, 7060, 7080 (Serviceable Only)	

B9016-055	Rectangular Fender & Cab Mount Warning Light	\$32.99
	Restoration Quality 12 Volt Rectangular Light One Red and One Amber Lens With Amber Side Marker 4.5" Wide & 1/2" Diameter Stud Allis Chalmers Fits: Various Models	

PARTS FOR LIGHT ABOVE

B9017-069	Sealed Beam, 12 Volt Bulb	\$19.99
	Combination Rear Lamp w/ transparent red background using separate bulb Replaces: 235583, 250301, 70235583, 70250301	

B9017-115	LED Combination Rear Light Bulb, Red/White, Sealed Beam	\$49.99
	Flood Pattern, 18 Watts, 1200 Lumens, Can Be Switched to White or Red Light Allis Chalmers Replaces: 235583, 250301, 70235583, 70250301 Fits 4 1/2" O.D. Housing with Either Metal or Rubber Bezel	

B9017-097	12-Volt LED Lamp, Trapezoid Beam Pattern	\$49.99
	4 1/2" diameter Allis Chalmers Replaces: #230232, 70232232, 70276858 Fits: D10 (SN: 3501 to 9000), D12 (SN: 3001 to 9000), D14 (SN: 19001 & up), D21, 160, 170, 175, 180, 185, 190, 190XT, 200, 7000, 7010, 7020, 7030, 7040, 7045, 7050, 7060, 7080, 8550	

B9017-098	12-Volt LED Lamp, Flood Beam Pattern	\$49.99
	4 1/2" diameter Allis Chalmers Replaces: #1164605, 239804, 70239804, 71164605 GE: #4410, 4411 Fits: D21, 160, 170, 175, 180, 185, 190, 190XT, 200, 5040, 5050, 6040, 6060, 6080, 7000, 7010, 7020, 7030, 7040, 7045, 7050, 7060, 7080, 7580, 8550	

Allis Chalmers 6 Volt Tail Light

B9016-008	6 Volt	\$45.99
B9016-011	12 Volt	\$45.99
	Restoration Quality 6 or 12 Volt Chrome Rear Lamp with 2 1/8" O.D. Red Glass Lens Includes base Gasket Allis Chalmers Replaces: 225038, 228377 Fits: B, C, CA, G, WD, WD45, D10, D12 Serial #9001 & up, D14 Serial #19001 & up	

PARTS FOR LIGHT ABOVE

B9017-095	Tail Light Gasket	\$2.99
------------------	--------------------------	---------------

DASH LAMPS



B9016-009	Chrome Finish Dash Lamp	\$29.95
	12 Volt, Chrome Finished Dash Lamp. <u>Bulb not Included.</u> Stand-alone bulbs #B9017-046 & #B9017-049 are Fitted for this part. Allis Chalmers Replaces: #70234404, 234404, 230247, 70230247, 229203, 70229203 Fits: 190XT, D10, D12, D14, D15, D17, D19, D21, I40, I400, I60, 170, 175, 180, 185, 190, 200, 210, 220, Backhoe: I600	

Light Bulbs

B9017-046	6 Volt Bulb	\$1.25
B9017-049	12 Volt Bulb	\$1.25
	Light bulbs for products #B9016-009	

B9017-036	6-Volt Sealed Beam Bulb	\$14.50
	30 Watt, Double Contact, 4.5" Diameter, Low Beam Allis Chalmers Replaces: GE #4511 Fits: [170, 175, 180, 185, 190, 190XT (not original look)] 200, 6040, 6060, 6080, 7000, 7010, 7020, 7030, 7040, 7045, 7050, 7060, 7080	

AUXILIARY PLUG & SOCKET

B9032-001	2 Pole Auxiliary Plug	\$23.75
	Fits: Allis Chalmers -D17, D19, WD45	
B9032-002	2 Pole Auxiliary Connector	\$19.75
	(Used With B9032-001) Fits: Allis Chalmers -D17, D19, WD45	

CIGARETTE LIGHTERS

B9030-001	6 Volt Cigarette Lighter	\$29.99
	With Anodized Aluminum Knob Engraved with the word Lighter Allis Chalmers Replaces: #70230228, 230228, 70228344, 228344 Fits: D14 (up to SN: 19000 with 6 volt systems)	
B9030-002	12 Volt Cigarette Lighter	\$29.99
	With Anodized Aluminum Knob Engraved with the word Lighter Replaces: Allis Chalmers - #230228, 232810, 230236, 70230236, 229502, 228343, 70229502, 70232810, 70230228, 70228343 Fits: Allis Chalmers - D14 (SN: 19001 & up with 12 volt system), D17 (With 12 volt system)	

CARBURETOR REBUILD KITS

B9022-008	Zenith Carburetor Rebuild Kit	\$26.95
	Allis Chalmers Tractors Model B, C, CA, DB10, D12, RC, W, WC, WF Fits Carburetor: Zenith Carburetor: #S1203, S1204, 8979, 9705, 9706, 9707, 9707A, 9707C, 9804, 10697, 10697A, 10698, 10698A, 10699, 10699A, 10902, 10902A, 10981, 10981A, 11141, 11141A, 11142, 11142A, 12401, 12522, 12544, 12566, 12749, 14544 Allis-Chalmers Carburetor: #209312, 211954, 212844, 212844-2, 212845, 212845-2, 213348, 224641, 224749, 225621, 225622, 231914, 235975	

B9022-023	Marvel-Schebler Carburetor Rebuild Kit	\$24.50
	Allis Chalmers Tractor Model B, C, CA, D14, D15 (Up to Serial #9000), H3 (Up to Serial #6959), IB, RC, WC, WD, WF Fits Carburetor: Marvel-Schebler: #1004SL, TSX101, TSX102, TSX103, TSX112, TSX113, TSX114, TSX119, TSX120, TSX126, TSX128, TSX13, TSX132, TSX132A, TSX133, TSX134, TSX136, TSX137, TSX138, TSX140, TSX141, TSX142, TSX144, TSX146, TSX147, TSX148, TSX150, TSX151, TSX154, TSX155, TSX156, TSX157, TSX159, TSX161, TSX167, TSX171, TSX173, TSX179, TSX180, TSX182, TSX183, TSX184, TSX186, TSX188, TSX189, TSX190, TSX191, TSX192, TSX193, TSX194, TSX197, TSX198, TSX202, TSX203, TSX206, TSX206-1, TSX211, TSX212, TSX225, TSX228, TSX231, TSX237, TSX239, TSX239-1, TSX240, TSX241A, TSX241B, TSX241C, TSX246, TSX248, TSX253, TSX254, TSX258, TSX260, TSX264, TSX266, TSX267, TSX269, TSX272, TSX274, TSX278, TSX28, TSX280, TSX286, TSX287, TSX288, TSX289, TSX29, TSX290, TSX297, TSX30, TSX301, TSX305, TSX306, TSX308, TSX309, TSX312, TSX314, TSX315, TSX319, TSX322, TSX323, TSX326, TSX328, TSX33, TSX330, TSX331, TSX332, TSX333, TSX334, TSX335, TSX338, TSX339, TSX34, TSX341, TSX346, TSX347, TSX348, TSX35, TSX351, TSX352, TSX356, TSX357, TSX358, TSX359, TSX36, TSX361, TSX361-A, TSX363, TSX366, TSX367, TSX368, TSX37, TSX370, TSX370-1, TSX377, TSX38, TSX380, TSX388, TSX389, TSX39, TSX391, TSX398, TSX400, TSX403, TSX405, TSX406, TSX407, TSX409, TSX418, TSX419, TSX42, TSX420, TSX421, TSX422, TSX423, TSX428, TSX43, TSX44, TSX443, TSX447, TSX448, TSX45, TSX450, TSX452, TSX453, TSX455, TSX458, TSX459, TSX465, TSX470, TSX472, TSX474, TSX48, TSX480, TSX481, TSX484, TSX486, TSX49, TSX497, TSX500, TSX507, TSX510, TSX513, TSX514, TSX516, TSX518, TSX520, TSX525, TSX531, TSX532, TSX534, TSX539, TSX54, TSX541, TSX55, TSX551, TSX552, TSX556, TSX558, TSX560, TSX567, TSX569, TSX570, TSX573, TSX577, TSX58, TSX580, TSX589, TSX59, TSX593, TSX595, TSX597, TSX60, TSX603, TSX605, TSX606, TSX611, TSX614, TSX618, TSX626, TSX633, TSX635, TSX643, TSX646, TSX649, TSX649-1, TSX650, TSX653, TSX655, TSX656, TSX660, TSX663, TSX665, TSX668, TSX670, TSX671, TSX676, TSX680, TSX681, TSX683, TSX69, TSX690, TSX691, TSX692, TSX694, TSX696, TSX701, TSX706, TSX709, TSX710, TSX714, TSX730, TSX736, TSX74, TSX742, TSX744, TSX748, TSX753, TSX76, TSX762, TSX765, TSX767, TSX770, TSX771, TSX776, TSX776-1, TSX78, TSX781, TSX787, TSX79, TSX793, TSX796, TSX80, TSX802, TSX803, TSX804, TSX809, TSX812, TSX815, TSX820, TSX826, TSX827, TSX83, TSX830, TSX841, TSX844, TSX85, TSX851, TSX855, TSX857, TSX860, TSX862, TSX864, TSX865, TSX866, TSX879, TSX88, TSX882, TSX89, TSX896, TSX896SL, TSX90, TSX901, TSX91, TSX912, TSX913, TSX914, TSX919, TSX926, TSX930, TSX931, TSX936, TSX936SL, TSX937, TSX937SL, TSX94, TSX948, TSX949, TSX95, TSX954, TSX957, TSX957SL, TSX95A, TSX96, TSX971, TSX976, TSX978, TSX979, TSX979-1, TSX98, TSX983, TSX986, TSX987, TSX99, TSX990, TSX991, TSX991-1, TSX996, TSXU828, TSXU829, TSXU830, TSXU831, TSXU832, TSXU833, TSXU834, 1003 Allis Chalmers Carburetor: #219996, 222089, 222090, 222091, 224750, 225090, 225679, 226623, 226624, 228623, 228624, 234228, 235537, 241102, 246468, 250137	

B9022-011	Zenith Carburetor Rebuild Kit	\$24.99
 <p>Allis Chalmers Tractors Model D17, H-300, 170 Fits Carburetor: Zenith Carburetor #11588, 12217, 12232, 12590, 12991, 13044, 13924, 14991, 14992 Allis-Chalmers Carburetor #226257, 229342, 239939, 233628, 249982, 4020322-2</p>		

B9022-016	Zenith Carburetor Rebuild Kit	\$24.99
 <p>Allis Chalmers Tractors Model D19, G-262, GT-2800, 180, 190, 190XT Fits Carburetor: Zenith Carburetor #10555, 10987, 11019, 11177, 11177A, 11177B, 11178, 11178A, 11178B, 11652, 11692, 11880, 12053, 12511, 12540, 12541, 12640, 12652, 12777, 12863, 12893, 12918, 12957, 12978, 13148, 13303, 13327, 13343, 13368, 13410, 13411, 13441, 13478, 13544, 13598, 13686 Allis-Chalmers Carburetor #4514151, 4021805 Replaces: Zenith - #K2039, K2040</p>		

B9022-017	Marvel-Schebler Carburetor Rebuild Kit	\$39.75
 <p>Allis Chalmers Tractors Model G Fits Carburetor: Marvel-Schebler Carburetor #TSV-16, TSV-24</p>		

B9022-005	Marvel-Schebler Carburetor Rebuild Kit	\$23.99
 <p>Allis Chalmers Tractors Model 170, 175, 180, 185, D15 (Serial #9001 & Up), D17, G-2500, H3 (Serial #6960 & Up), WD45 Replaces: Allis Chalmers - #226258, 226275, 231431, 236568, 237860, 239961, 1122922, 4022815 Fits Carburetor: Marvel-Schebler Carburetor: TSX1001, TSX1002, TSX181, TSX221, TSX245, TSX296, TSX332, TSX360, TSX374, TSX397, TSX413, TSX414, TSX436, TSX464, TSX466, TSX475, TSX492, TSX505, TSX506, TSX506A, TSX526, TSX528, TSX530, TSX561, TSX562, TSX563, TSX575, TSX582, TSX592, TSX596, TSX602, TSX605, TSX606, TSX610, TSX615, TSX633, TSX639, TSX641, TSX645, TSX648, TSX662, TSX678, TSX688, TSX689, TSX695, TSX704, TSX711, TSX713, TSX719, TSX721, TSX725, TSX732, TSX737, TSX738, TSX755, TSX756, TSX757, TSX759, TSX768, TSX769, TSX772, TSX773, TSX775, TSX777, TSX784, TSX788, TSX791, TSX792, TSX797, TSX798, TSX799, TSX800, TSX801, TSX806, TSX808, TSX810, TSX811, TSX813, TSX814, TSX816, TSX819, TSX825, TSX836, TSX843, TSX849, TSX853, TSX854, TSX856, TSX857, TSX867, TSX869, TSX871, TSX877, TSX878, TSX881, TSX883, TSX884, TSX885, TSX886, TSX888, TSX889, TSX892, TSX892S, TSX893, TSX894, TSX895, TSX897, TSX898, TSX899, TSX900, TSX902, TSX903, TSX904, TSX904SL, TSX905, TSX905-1, TSX905SL, TSX906, TSX906SL, TSX907, TSX907SL, TSX908, TSX908SL, TSX911, TSX917, TSX920, TSX920SL, TSX921SL, TSX922, TSX922SL, TSX923, TSX923SL, TSX925, TSX927, TSX928, TSX932, TSX932SL, TSX933, TSX934, TSX934SL, TSX938, TSX938SL, TSX939, TSX940, TSX940SL, TSX941, TSX941SL, TSX942, TSX943, TSX944SL, TSX945SL, TSX946, TSX947SL, TSX949, TSX950, TSX952, TSX952SL, TSX955, TSX959, TSX959SL, TSX961, TSX961SL, TSX962, TSX962SL, TSX964SL, TSX965SL, TSX966, TSX967SL, TSX968SL, TSX97, TSX972, TSX973, TSX974, TSX974SL, TSX975, TSX975SL, TSX977, TSX980, TSX980SL, TSX984SL, TSX985, TSX985SL, TSX988, TSX989, TSX993, TSX994, TSX997, TSX998, TSX999, TSXU1006, TSXU1007, TSXU835, TSXU836, TSXU840, TSXU904, TSXU904SL, TSXU905, TSXU905-1, TSXU944SL, TSXU963, TSXU9631, TSXU995</p>		

CARBURETOR FLOATS

B9023-003	Marvel-Schebler Carburetor Float	\$12.75
 <p>Allis Chalmers Tractors Model B, C, CA, D14, D15, H-3, RC, R1B, T100, W, WC, WD, WF Replaces: Allis Chalmers: #70219985 Fits Carburetor: Marvel-Schebler Carburetor: #TSX-138, TSX-154, TSX-159, TSX-186, TSX-264, TSX-305, TSX-363, TSX-380, TSX-422, TSX-470, TSX-486, TSX-514, TSX-670, TSX-701, TSX-815, TSX-844, TSXU-828, TSXU-832, TSXU-834, TSX-879, TSX-912 Replaces: Marvel Schebler: #30-600 Allis-Chalmers Carburetor: #222089, 222090, 224750, 225090, 225091, 225679, 228623, 228624, 234228, 235537, 241102, 246468, 2501372</p>		

B9023-007	Zenith Carburetor Float	\$16.99
 <p>Allis Chalmers Tractors Model B, C, CA, DB10, D12, RC, WC, WD, WF Replaces: Allis Chalmers: #70223920 Zenith: #C85-28 Fits Carburetor: Zenith Carburetor #S1203, S1204, 8979, 9705, 9706, 9707, 9707A, 9707C, 9804, 10697, 10697A, 10698, 10698A, 10699, 10699A, 10902, 10902A, 10981, 10981A, 11141, 11141A, 11142, 11142A, 12401, 12522, 12544, 12566, 12749, 14544 Allis-Chalmers Carburetor: #209312, 211954, 212844, 212844-2, 212845, 212845-2, 213348, 224641, 224749, 225621, 225622, 231914, 235975</p>		

B9023-004	Marvel-Schebler Carburetor Float	\$19.95
	<p>Allis Chalmers Tractors Model D-15, D-17 G-2500, WD-45, 175, 180 Replaces: Allis Chalmers: #70226456 Marvel Schebler: #30-739, 30-631 Marvel-Schebler Carburetor #TSX-464, TSX-561, TSX-773, TSX-869, TSX-871, TSX-928, TSXU-836, TSXU-840, TSX-950, TSXU-963 Allis Chalmers Carburetor: #226258, 226275, 231431, 237860, 239961, 248868-04, 4022815</p>	

B9023-002	Marvel-Schebler Carburetor Float	\$26.99
	<p>Allis Chalmers Tractors Model G Replaces: Allis Chalmers: #800303, 800472, 70800472 Marvel Schebler: #30-667 Marvel-Schebler Carburetor: #TSV13, TSV15, TSV16, TSV17, TSV18, TSV21, TSV22, TSV24, TSV27, TSV35, TSV37, TSV45, TSV47, TSV48, TSV49, TSV50, TSV52, TSV53, TSV54</p>	

B9023-015	Zenith Carburetor Float	\$24.99
	<p>Allis Chalmers Tractors Model D15, D17, H3, WD45, 170, 175, 180. (Industrial) – I60, I600. Replaces: Allis Chalmers: #227103. Zenith: #C85-115, C85-115S Fits Carburetor: (various- see www.brillman.com)</p>	

CARBURETOR ACCESSORIES

B9038-003	Carburetor Elbow Fuel Line Fitting with Strainer	\$7.99
	<p>Elbow Fuel Line Fitting with strainer for IHC carburetors. 1/8" Pipe to 1/4" Flare. Works with Carter UT Series and Various Marvel-Schebler Carburetors. Fits: Allis Chalmers - B, C, CA, G, D10, D12, D14, D15, D17, D19, D21, RC, U, WC, WD, WD45, WF, 170, 175, 180, 185, 190, 190XT, 210, 220, 7000, 7030, 7040, 7050, 7060, 7080</p>	

B9038-007	2" Sediment Bowl Gasket	\$2.19
	<p>2" Outer Diameter, Bowl to Body; Fits a 1.28" Tall Glass Bowl Allis Chalmers Replaces: 208362, 70208362 Fits: B, C, CA, G, D10, D12, D14, D15 (Gas, to SN: 9001), D17 (Gas, to SN: 42,000), D19 (Gas, to SN: 12,000), IB, I40, I60 (Gas), I400, I600 (Gas), RC, WC, WD, WD45, WF, 170 (Gas), 175 (Gas), 180 (Gas)</p>	

FUEL SEDIMENT BOWLS

B9036-001	Fuel Sediment Bowl	\$27.99
	<p>Has a 3/8" Pipe Inlet and a 1/8" Pipe Outlet. Bowl is 1.280" Long. Shallow Bowl has 90° Outlet Only. Allis Chalmers Replaces: #235560, 237944, 70235560, 70237944 Fits (Gas): B, C, CA, D14, I40, I400, I60, IB, RC, D15 (to SN: 9001), D17 (to SN: 42000), D19 (to SN: 12000)</p>	

B9036-002	Fuel Sediment Bowl	\$34.99
	<p>Has a 3/8" Pipe Inlet, 1/8" Pipe Outlet, and a 2.315" tall glass bowl Allis Chalmers Replaces: #237946, 70237946 Fits (Using 2.315 Long Glass Bowl)... (...& Gas Only & Single Outlet): U, UC (...& Gas, SN: 9001 & up, and All Diesel): D15 (...& Gas, SN: 42001 & up, and all Diesel): D17, D19 (...& Gas, Diesel): 190, 190XT (...& Diesel): D21, WD45, 170, 175, 180, 185</p>	

Parts for Sediment Bowl Above

B9038-024	Connector w/ Female Fitting	\$8.99
B9038-008	2" Sediment Bowl Screen	\$3.99
B9038-012	Sediment Bowl Gasket	\$2.99

FUEL SYSTEM ACCESSORIES

B9038-009	Fuel Cap	\$10.99
	<p>Chrome Plated, 2.7" Outside Diameter, 1.88" Overall Tab Length, .25" Tab Width Allis Chalmers Replaces: 253690, 70253690 Fits: 170, 175, 180, 185, D10, D12, D14, D15, D17, D19, I40, I400, I60, I600 (Serviceable Only): B, C, CA, G, IB, RC, WC, WD, WD45, WF (for Styled)</p>	

COMPLETE DISTRIBUTORS

B9500-016	4-Cylinder Pertronix Distributor	\$279.95
	<p>12-Volt, Negative Ground Clockwise Rotation Fits: Allis Chalmers -1969-1974 (all models with clockwise distributors) Note: Must use Suppression Spark Plug Wire. Use of any other type of Wire will Void the Warranty.</p>	

AVERY, B.F. AVERY & SONS

TABLE OF CONTENTS

Spark Plug Wire Sets	66
Battery Cables	66
Wire Harnesses	67
Tune Up Parts for Battery Ignition	67
Electronic Ignition Conversion Kits	68
Tune Up Parts for Magneto Ignition	69
Replacement Magnetos	69
Gauges	70
Switches	70
Cutout Relays & Voltage Regulators	71
Brush Sets	71
Identification Tags	71
Alternators	72
Carburetor Floats	72
Fuel Sediment Bowls	72
Lights & Light Parts	72
Carburetor Rebuild Kits	72

SPARK PLUG WIRE SETS

Our Spark Plug Wire Sets Come Fully Assembled with the Proper Type Wire & Terminals.

They are Custom Tailored to Look & Fit Like Original Factory Equipment.

Varieties include:

Cotton Braid Wire: Copper Core with a Cotton Jacket.

PVC Wire: Copper Core with a Rubber Jacket.

EPDM Wire (E): Hi Performance Premium Conductor with a Tinned Copper Core, EPDM Silicone Insulation, and a Rubber Jacket.

Suppression Wire (S): for Electronic Ignition and is Spiral Wound, Ultra Low-Ohm, with EPDM Silicone Insulation and a Rubber Jacket.

Cotton Braid Suppression Wire (CS): also for Electronic Ignition, as Suppression Wire, but has an additional layer of Cotton Braid & Lacquer to replicate the vintage look, as well.



Avery Model 12-25 (1917)

2 Cyl. Tailored Spark Plug Wire Set

B1002-001	Original Type Cotton Braid Wire	\$27.25
B1002-001E	EPDM Wire	\$29.75

BF Avery A

4 Cyl. Tailored Spark Plug Wire Set

With Distributor & Hercules IXK Engine

B1003-001	Original Type Cotton Braid Wire	\$27.25
B1003-001E	EPDM Wire	\$29.75
B1003-001S	Suppression Wire	\$29.75
B1003-001CS	Cotton Suppression Wire	\$47.25

With Magneto & Hercules IXK/IXB-3 Engines

B1003-004	Original Type Cotton Braid Wire	\$27.25
B1003-004E	EPDM Wire	\$29.75

With Hercules IXB-3 Engine

B1003-005	Original Type Cotton Braid Wire	\$27.25
B1003-005E	EPDM Wire	\$29.75
B1003-005S	Suppression Wire	\$29.75
B1003-005CS	Cotton Suppression Wire	\$47.25

BF Avery BF & BG "1 Row"

4 Cyl. Tailored Spark Plug Wire Set

B1003-006	Original Type Cotton Braid Wire	\$23.75
B1003-006E	EPDM Wire	\$26.00
B1003-006S	Suppression Wire	\$26.00
B1003-006CS	Cotton Suppression Wire	\$41.00

BF Avery R with Hercules IXB-3XM Engine

4 Cyl. Tailored Spark Plug Wire Set

B1003-002	Original Type Cotton Braid Wire	\$27.25
B1003-002E	EPDM Wire	\$29.75
B1003-002S	Suppression Wire	\$29.75
B1003-002CS	Cotton Suppression Wire	\$47.25

BF Avery V with Hercules ZXB3 Engine

4 Cyl. Tailored Spark Plug Wire Set

B1003-003	Original Type Cotton Braid Wire	\$28.25
B1003-003E	EPDM Wire	\$30.75
B1003-003S	Suppression Wire	\$30.75
B1003-003CS	Cotton Suppression Wire	\$48.25

BATTERY CABLES



BF Avery A

B2003-001	Negative Battery Cable	\$30.75
B2003-002	Positive Battery Cable with Original Armor	\$48.50
B2003-006	Positive Battery Cable	\$28.50
B2003-003	Switch to Starter Cable	\$54.25

BF Avery BF/BG

B2003-004	Negative Battery Cable	\$44.50
B2000-007	Positive Ground Strap	\$14.50

BF Avery R

B2003-004	Negative Battery Cable	\$44.50
B2000-007	Positive Ground Strap	\$14.50

BF Avery V

B2003-005	Negative Battery Cable	\$31.50
B2000-005	Positive Ground Strap	\$12.50

Can add Original type **Steel Armor** for an additional cost of \$20.00



WIRING HARNESSSES

Our Wire Harnesses are made with our **premium cotton braid and/or PVC wire**. They have the **correct gauge, color, wire, & fuse holders** (if needed). All terminals are **soldered according to the original**.
(Harnesses do not include Battery Cables & Spark Plug Wires; however, we can supply these as separate products.)
NO HIDDEN COSTS, NOTHING EXTRA TO BUY!

BF Avery A Serial #7A013 & Up

B3003-004	Complete Wire Harness	\$165.25
B3003-005	Complete Wire Harness, Modified for a 1-Wire Alternator	\$165.25

BF Avery BF/BG "1 Row"

B3003-001	Complete Wire Harness	\$193.75
B3003-003	Complete Wire Harness, Modified for a 1-Wire Alternator	\$193.75
B3003-008	Complete Wire Harness, Modified for a 10SI Alternator	\$193.75

BF Avery R

B3003-006	Complete Wire Harness	\$193.50
B3003-007	Complete Wire Harness, Modified for a 1-Wire Alternator	\$193.50

BF Avery V

B3003-002	Complete Wire Harness	\$165.25
------------------	-----------------------	-----------------

TUNE UP PARTS FOR BATTERY IGNITION

Avery A, V, BF, R with Delco Distributor



	B4100-001	\$10.50
PCR Kit Includes: Points (#B4001-001), Condenser (#B4002-001), Rotor (#B4004-002) Replaces: Points - #D100HP, 1855720 Condenser - #1928111, D-203, 1869704, D-200 Rotor - #820445, D400		
	B4004-002	\$5.75
Rotor Replaces: #820445, D400		
	B4003-001	\$13.50
Distributor Cap Premium Grade, Made in the USA (Brass Contacts) Replaces: #811735, D300		



	B4006-001	\$9.99
Dust Cover Replaces: #1900119		
	B4007-001	\$11.95
Cap Clip Short Mount, 1 Used Replaces: #1889967, 1847289, 453844, 453461		
	B4007-002	\$11.95
Cap Clip Long Mount, 1 Used Replaces: #1889967, 1889999, 453844, 453461		
	B4008-001	\$14.99
Distributor Insulator Replaces: #1904376		
	B4009-001	\$25.99
Distributor Bushing & Shim Kit		



*For 6- or 12-Volt Ignition Coils & Accessories, see p.44

Avery A, V with Autolite Distributor		
B4100-004		\$14.75
	PCR Kit Includes: Points (#B4001-005), Condenser (#B4002-002), Rotor (#B4004-003) Replaces: Points - #1-4, 1-8, 1-9, 1-20, 1-22, 1-45, IAD-3128S, IGP-3028ES, IGP3028FS, IGS2224L, IGW3028AS Condenser - #2-23, 2-31, 2-32, 2-34, 2-38, 2-42, IAT-2015L, IAT-2015R, IAT-3076AS, IAT-3076BS, IAT-3076D, IAT-3076DS, IAT-3076L, IAT-3076LA, IAT-3076R, IAT-3076RA, IBB-2015L, IBB-2015R, IBB-2042-SS, IBB-2042SS-1, IBB-2042-SS3, IG-2671F, IGH-3076, IGW-3139, 2098058, 3420600 Rotor - #4-10	
	B4004-003	\$5.25
	Rotor Premium Grade, Made in USA Replaces: #4-10	
	B4003-003	\$21.00
	Distributor Cap Made in the USA (Brass Contacts) Replaces: #IG-1324D, 3-11, 3-12	

* For 6-Volt Ignition Coils & Accessories, see p.44

Avery Ro-Track (ZXB-5 Engine)		
	B4001-006	\$11.75
	Points Replaces: #1882022	
	B4002-003	\$4.75
	Condenser Replaces: #1928111, D203	

Avery A, BF, R with WICO Distributor #XB4100		
	B4011-004	\$17.75
	Points Replaces: #1-5008, 1-5111, FXH-2100B, FXH-2400B, X5996	
	B4002-004	\$11.00
	Condenser Replaces: #90-5072	
	B4013-004	\$36.75
	Cap Includes #B4016-004 Replaces: #3-5014	

	B4014-002	\$23.50
	Rotor Replaces: #4-5010	
	B4016-004	\$2.25
	Cap Gasket Replaces: #94-5076	

ELECTRONIC IGNITION CONVERSION KITS

Replaces Points & Condenser



Avery A, V, BF, R with Delco Distributor & Clip On Cap		
B9600-006	12 Volt Negative Ground	\$147.45
B9600-006P12	12 Volt Positive Ground	\$165.45
B9600-006P6	6 Volt Positive Ground	\$165.45

Avery A, V with Autolite Distributor		
B9600-057	12 Volt Negative Ground	\$129.95
B9600-057P12	12 Volt Positive Ground	\$147.45
B9600-057N6	6 Volt Negative Ground	\$147.45
B9600-057P6	6 Volt Positive Ground	\$147.45





***For Ignition Coils & Accessories, see p.44**

Did You Know?

Avery was famed for its undermounted engine which resembled a railroad engine more than a conventional farm steam engine.

TUNE UP PARTS FOR MAGNETO IGNITION

Avery A, BF, R with WICO Magneto #XH1163, XH1180, XH1604		
	B4011-004	\$17.75
	Points Replaces: #1-5008, 1-5111, FXH-2100B, FXH-2400B, X5996	
	B4012-002	\$13.75
	Condenser Replaces: #2-5007, X5614, X6916	
	B4017-040	\$2.75
	Condenser Clamp Replaces: #94-5167	
	B4013-004	\$36.75
	Cap Includes #B4016-004 Replaces: #3-5014	
	B4017-005	\$3.50
	Inner Bearing Replaces: #24-5000	
	B4017-006	\$9.75
	Outer Bearing Replaces: #25-5000	
	B4017-007	\$12.50
	Impulse Spring Replaces: #94-5016	
	B4017-046	\$2.75
	Bearing Cage Snap Ring Replaces: #43-5055	
	B4016-012	\$2.25
	Striker Plate Gasket Replaces: #94-5154	
	B9013-011	\$7.00
	WICO Series X Nameplate Fits the WICO Series X magneto (Rivets included)	

Avery with Fairbanks-Morse Magneto #FM-XR6A		
	B4014-017	\$36.50
	Rotor Replaces: #Z2765	
	B4013-036	\$87.50
	Cap Replaces: #Q800 Includes Cap Brush	

REPLACEMENT MAGNETOS

Rebuilt Magnetos

Our Rebuilt Magnetos are completely torn down, cleaned, & inspected. They will (at the minimum) have the following new parts: Points, Condenser, Coil, Coil Insulators, Lead-out Tower, & Outside Covers, plus any additional parts that are needed to make the unit look & perform like new.

They come with a 1-Year Limited Warranty.

Notes:

1. Unless otherwise specified, cost is exchange price.
2. A core charge (see below) will be charged to your credit card until we receive your good core.
3. A good core is considered a complete magneto with no cracks or weld repairs. Only good cores will be credited.

Magnetos must be used with copper ignition wire. Use of any other type will Void the Warranty.

	XH184R	Exchange	\$445.00
		Outright	\$645.00
Rebuilt WICO Magneto 4 Cyl. Base Mount Core Charge: \$200.00			
	XH894R	Exchange	\$445.00
		Outright	\$645.00
Rebuilt WICO Magneto 4 Cyl. Flange Mount Core Charge: \$200.00			

GAUGES

Ammeters, Universal

B9025-002	Ammeter 20-0-20	\$19.99
	Has a black face with white lettering and a chrome bezel Does not have a logo. Dimensions: Fits in 2" Diameter Hole 1.850" From Post to Bottom of Bezel Avery Fits: A, BF, BG, R, V	

B9025-005	Ammeter 30-0-30	\$19.99
	Has a black face with white lettering and a chrome bezel. Does not have a logo. Dimensions: Fits in a 2" Diameter Hole 1.740" From Top of Post to Bottom of Bezel	

Oil Pressure Gauges

B9025-004	Universal Oil Pressure Gauge (0-50 PSI)	\$21.99
	Has 1/8" NPT MALE THREADS, studs, & a bracket. Has a black face with white lettering and a chrome bezel. Does not have a logo. Dash-mounted, requires a 2" diameter hole..	

Water Temperature Gauges

B9025-006	Water Temperature Gauge	\$34.99
	Includes an Aluminum Sealing Washer to Seal Probe. Has a Chrome Bezel with White, Green, & Red Zones on a Black Gauge Face. 1/2" NPT Pipe Bushing and Probe Length of 1.279". Avery Fits: BG (And Other Models Using 60" Capillary Lead)	

B9025-007	Universal Water Temperature Gauge	\$34.99
	Dash-mounted (parts included), 72" long heavy duty capillary tube included (check length before ordering) Avery Fits: BG (And Others Using 72" Or Shorter Capillary Lead)	

Oil Pressure Gauge, Line Kit

B9026-001	Oil Pressure Gauge Line Kit	\$29.99
	6 FT copper 1/8" line --- Kit includes: (2) 5/16 - 24 UNF nut, (2) compression sleeves, (1) 1/8 - 27 NPTF female to 5/16" - 24 UNF male adapter. Note: Depending on application customer may be required to purchase other fittings.	

SWITCHES

Push/Pull Switches

B5002-001	2 Position Push/Pull Switch	\$7.75
	OFF/ON Universal 2 Position Push/Pull (2 Screw Terminals) Mounting Stem 3/8"-32 Thread Knob #10/32 Thread	

B5002-005	3-Position Push/ Pull Switch	\$29.75
	Low Charge/High Charge/Lights (3 Position Switch) 3 Screw Type Mounting Stem .8" Thread Knob #10/32 Thread Premium Quality Made by an OEM Manufacturer Avery Replaces: #AT261	

B5002-004	Heavy Duty Push/Pull Magneto Switch	\$8.25
	ON/OFF (2 Position) Push/Pull Magneto Switch (2 Screw Terminals) Mounting Stem 3/8"-32 Thread Knob #10/32 Thread	

Key Switches

B5003-001	2 Position Battery Key Switch	\$14.75
	Universal OFF/ON 2 Position Key Switch (For Battery Ignition) (2 Screw Terminals) Mounting Stem 3/4"-20 Thread	

COMBINATION SWITCHES

B5009-003	Combination Switch with Lever	\$94.99
	5 Position, 30 Amp Combination Switch With Lever (5 Screw Type Terminals) BF Avery Replaces #VT508 Fits: V (All With Cut-Out Relay)	

Momentary Switches

B5004-003	Momentary Push Switch	\$15.75
	Manual Push Button Solenoid Switch with Rubber Protected Cap (2 Screw Terminals) Mounting Stem 5/8"-32 Thread Avery Replaces: VT507 Fits: BF, BG, R, V (Starter Button)	

CUTOUT RELAYS & VOLTAGE REGULATORS

Note: Due to modern battery design, voltage regulators can't be used to charge low or dead batteries. Doing so will destroy the voltage regulator and void the warranty.

B8001-001	6-Volt Cutout Relay	\$19.50
	15 Amps, 6 Volt Works Positive or Negative Ground Replaces: Autolite - CB4014, C4012(9-5), C4012(9-4), C4012(9-1), R40061 Delco - #266P, 266N, 265P, 265N, 5015850, 812970, 265J, 820845, 812971, 1116816, 265G, 265H, 1116755, 1116751, 1116809DR, 265B, 1842859, 265C, 1867781, 265F, 265D Fits: BF Avery - A BF, BG, R, V	

B8001-002	Electronic Cutout Relay	\$19.50
	25 Amp, Works with 6, 12, or 24 Volts. & Positive/Negative Ground Replaces: Autolite - #CB4014, C4012 (9-5), C4012 (9-4), C4012 (9-1), R40061 Delco - #266P, 266N, 265P, 265N, 5015850, 812970, 265J, 820845, 812971, 1116816, 265G, 265H, 1116755, 1116751, 1116809DR, 265B, 1842859, 265C, 1867781, 265F, 265D Fits: BF Avery - A BF, BG, R, V	



6-Volt Saddle Mounted Cutout Relay (Delco Version)

B8001-004	Premium Quality, Made in the USA	\$122.50
B8001-006	Standard Quality	\$38.59
	Cutout Relay, 25 Amp, 6 Volt, Works Positive or Negative Ground. Replaces: Delco - #266P, 266N, 265P, 265N, 5015850, 812970, 265J, 820845, 812971, 1116816, 265G, 265H, 1116755, 1116751, 1116809DR, 265B, 1842859, 265C, 1867781 265F, 265D Fits: BF Avery - A BF, BG, R, V	



6-Volt Delco Type Voltage Regulator

B8002-011	Premium Quality, USA Made	\$124.75
B8002-012	Standard Quality	\$42.75
	6 Volt, 4 Terminals, Curved Bracket Replaces: Delco - 1116766, 1118265, 1118305, 1118433, 1118436, 1118790, D641, D642, D643, D647, D660, D661 Prestolite - 8-293, GRX-293 Fits: B.F. Avery: V <i>Delco Generator #1101659</i>	

BRUSH SETS

X348	Brush Set	\$6.00
	B. F. Avery & Sons Fits: BF, R, Ro-Track, V Used with Delco Generator #1101659	
X360	Brush Set	\$6.25
	Used with Delco Generator #1101851	
X349	Brush Set	\$7.75
	Used with Delco Generator #1101856	

IDENTIFICATION TAGS

B9013-001	Small Autolite I.D. Tag (Blank)	\$7.00
	Small Autolite I.D. Tag (Stamped)	\$14.25
	2 5/16" Long, Black I.D. Tag for Distributors, Starters, & Generators with Rivets	
B9013-002	Large Autolite I.D. Tag (Blank)	\$7.00
	Large Autolite I.D. Tag (Stamped)	\$14.25
	2 15/16" Long, Black I.D. Tag for Distributors, Starters, & Generators with Rivets	

Delco Remy

B9013-004	Delco Remy I.D. Tag (Blank)	\$7.00
	Delco Remy I.D. Tag (Stamped)	\$14.25
	Black Delco-Remy I.D. Tag for Distributors, 6 Volt Starters, & 6 Volt Generators with Rivets, 3/4" 2 5/16"	
B9013-005	Red Delco Remy I.D. Tag (Blank)	\$7.00
	Red Delco Remy I.D. Tag (Stamped)	\$14.25
	Red Delco-Remy I.D. Tag for 12 Volt Starters & 12 Volt Generators with Rivets, 3/4" 2 5/16"	
B9013-013	Delco Remy I.D. Tag (Blank)	\$7.00
	Delco Remy I.D. Tag (Stamped)	\$14.25
	Black Delco-Remy I.D. Tag for Distributors, 6 Volt Starters, & 6 Volt Generators with Rivets, 3/4" 2 5/16"	

ALTERNATORS

Delco 10SI Type



B6001-001	12 Volt Alternator (1 Wire)	\$112.75
63 Amp, Low Cut In, Specially Built For Tractors, Forklifts, & Other Low Engine Speed Applications		
B6001-005	6 Volt Alternator (1 Wire, Positive Ground)	\$166.50
6 Volt, 40 Amp Alternator with Positive Ground, 1 Wire, 3/8" pulley		

Small ND Type

B6002-003	12 Volt Small Denso Alternator (1 Wire)	\$119.75
	40 Amp, 1 Wire Internal Regulator. Will Start Charging with a Much Lower Engine Speed. Comes with a 4 1/2" Housing Diameter, 3/8 To 1/2" Belt width & a 2 1/2" Pulley Diameter. Excellent for Converting a 6 Volt System to 12 Volt. Negative Ground Only & is Self-Excited	

CARBURETOR FLOATS

B9023-003	Marvel-Schebler Carburetor Float	\$12.75
	B.F. Avery Tractors Model B, BF 1 Row Replaces Carburetor: Marvel-Schebler Carburetor: TSX-400, TSX-421, TSX-514, TSXU-829, TSXU-831, TSXU-833, TSXU-834 Replaces: Marvel Schebler: #30-600	

FUEL SEDIMENT BOWLS

B9036-001	Fuel Sediment Bowl	\$27.99
	Has a 3/8" Pipe Inlet and a 1/8" Pipe Outlet. Bowl is 1.280" Long. Shallow Bowl has 90° Outlet Only. B.F. Avery Replaces: #0W426A, 112180, VT505 Fits: [A, BF, BG, R, V (Gas)]	

LIGHTS & LIGHT PARTS

Headlight Assembly		
B9016-040	Bullet Type 6 Volt Head	\$53.99
B9016-041	Bullet Type 12 Volt Head	\$53.99
	B.F. Avery Fits: A, BF, BG, R, V	

CARBURETOR REBUILD KITS

B9022-023	Marvel-Schebler Carburetor Rebuild Kit	\$24.50
	<p>B.F. Avery Tractor Model A, B, BF, BG, R Marvel-Schebler Carburetor: #1004SL, TSX101, TSX102, TSX103, TSX112, TSX113, TSX114, TSX119, TSX120, TSX126, TSX128, TSX13, TSX132, TSX132A, TSX133, TSX134, TSX136, TSX137, TSX138, TSX140, TSX141, TSX142, TSX144, TSX146, TSX147, TSX148, TSX150, TSX151, TSX154, TSX155, TSX156, TSX157, TSX159, TSX161, TSX167, TSX171, TSX173, TSX179, TSX180, TSX182, TSX183, TSX184, TSX186, TSX188, TSX189, TSX190, TSX191, TSX192, TSX193, TSX194, TSX197, TSX198, TSX202, TSX203, TSX206, TSX206-1, TSX211, TSX212, TSX225, TSX228, TSX231, TSX237, TSX239, TSX239-1, TSX240, TSX241A, TSX241B, TSX241C, TSX246, TSX248, TSX253, TSX254, TSX258, TSX260, TSX264, TSX266, TSX267, TSX269, TSX272, TSX274, TSX278, TSX28, TSX280, TSX286, TSX287, TSX288, TSX289, TSX29, TSX290, TSX297, TSX30, TSX301, TSX305, TSX306, TSX308, TSX309, TSX312, TSX314, TSX315, TSX319, TSX322, TSX323, TSX326, TSX328, TSX33, TSX330, TSX331, TSX332, TSX333, TSX334, TSX335, TSX338, TSX339, TSX34, TSX341, TSX346, TSX347, TSX348, TSX35, TSX351, TSX352, TSX356, TSX357, TSX358, TSX359, TSX36, TSX361, TSX361-A, TSX363, TSX366, TSX367, TSX368, TSX37, TSX370, TSX370-1, TSX377, TSX38, TSX380, TSX388, TSX389, TSX39, TSX391, TSX398, TSX400, TSX403, TSX405, TSX406, TSX407, TSX409, TSX418, TSX419, TSX42, TSX420, TSX421, TSX422, TSX423, TSX428, TSX43, TSX44, TSX443, TSX447, TSX448, TSX45, TSX450, TSX452, TSX453, TSX455, TSX458, TSX459, TSX465, TSX470, TSX472, TSX474, TSX48, TSX480, TSX481, TSX484, TSX486, TSX49, TSX497, TSX500, TSX507, TSX510, TSX513, TSX514, TSX516, TSX518, TSX520, TSX525, TSX531, TSX532, TSX534, TSX539, TSX54, TSX541, TSX55, TSX551, TSX552, TSX556, TSX558, TSX560, TSX567, TSX569, TSX570, TSX573, TSX577, TSX58, TSX580, TSX589, TSX59, TSX593, TSX595, TSX597, TSX60, TSX603, TSX605, TSX606, TSX611, TSX614, TSX618, TSX626, TSX633, TSX635, TSX643, TSX646, TSX649, TSX649-1, TSX650, TSX653, TSX655, TSX656, TSX660, TSX663, TSX665, TSX668, TSX670, TSX671, TSX676, TSX680, TSX681, TSX683, TSX69, TSX690, TSX691, TSX692, TSX694, TSX696, TSX701, TSX706, TSX709, TSX710, TSX714, TSX730, TSX736, TSX74, TSX742, TSX744, TSX748, TSX753, TSX76, TSX762, TSX765, TSX767, TSX770, TSX771, TSX776, TSX776-1, TSX78, TSX781, TSX787, TSX79, TSX793, TSX796, TSX80, TSX802, TSX803, TSX804, TSX809, TSX812, TSX815, TSX820, TSX826, TSX827, TSX83, TSX830, TSX841, TSX844, TSX85, TSX851, TSX855, TSX857, TSX860, TSX862, TSX864, TSX865, TSX866, TSX879, TSX88, TSX882, TSX89, TSX896, TSX896SL, TSX90, TSX901, TSX91, TSX912, TSX913, TSX914, TSX919, TSX926, TSX930, TSX931, TSX936, TSX936SL, TSX937, TSX937SL, TSX94, TSX948, TSX949, TSX95, TSX954, TSX957, TSX957SL, TSX95A, TSX96, TSX971, TSX976, TSX978, TSX979, TSX979-1, TSX98, TSX983, TSX986, TSX987, TSX99, TSX990, TSX991, TSX991-1, TSX996, TSXU828, TSXU829, TSXU830, TSXU831, TSXU832, TSXU833, TSXU834, 1003 B.F. Avery Carburetor: #10A2944, 120320, 135119</p>	

BEST

Best 30 Crawler

4 Cyl. Tailored Spark Plug Wire Set

B1004-001	Original Type Cotton Braid Wire	\$31.50
------------------	--	----------------

BOBCAT

Bobcat Model 610, 630, 720 Skid Steer

Wisconsin VH4D Engine with Side Mount Distributor

4 Cyl. Tailored Spark Plug Wire Set

B1107-003	Original Type PVC Wire	\$29.00
B1107-003E	EPDM Wire	\$34.00
B1107-003S	Suppression Wire	\$34.00

Bobcat Model 632 Skid Steer

Ford Engine

4 Cyl. Tailored Spark Plug Wire Set

B1107-005	Original Type EPDM Wire	\$29.25
------------------	--------------------------------	----------------

Bobcat Model 732, 742 Skid Steer

Ford Engine

4 Cyl. Tailored Spark Plug Wire Set

B1107-001	Original Type Suppression Wire	\$29.25
------------------	---------------------------------------	----------------

Bobcat Model 642B, 742B Skid Steer

Mitsubishi Engine

4 Cyl. Tailored Spark Plug Wire Set

B1107-002	Original Type Suppression Wire	\$29.25
------------------	---------------------------------------	----------------

BRIGGS & STRATTON

Briggs & Stratton WI

1 Cyl. Tailored Spark Plug Wire Set

B1005-001	Original Type Cotton Braid Wire	\$8.00
------------------	--	---------------

BUDA ENGINES

Buda #6B230

4 Cyl. Tailored Spark Plug Wire Set

B1006-001	Original Type PVC Wire	\$39.50
B1006-001E	EPDM Wire	\$43.00

SPARK PLUG WIRE SETS

Our Spark Plug Wire Sets Come Fully Assembled with the Proper Type Wire & Terminals.

They are Custom Tailored to Look & Fit Like Original Factory Equipment.

Varieties include:

Cotton Braid Wire: Copper Core with a Cotton Jacket.

PVC Wire: Copper Core with a Rubber Jacket.

EPDM Wire (E): Hi Performance Premium Conductor with a Tinned Copper Core, EPDM Silicone Insulation, and a Rubber Jacket.

Suppression Wire (S): for Electronic Ignition and is Spiral Wound, Ultra Low-Ohm, with EPDM Silicone Insulation and a Rubber Jacket.

Cotton Braid Suppression Wire: also for Electronic Ignition, as Suppression Wire, but has an additional layer of Cotton Braid & Lacquer to replicate the vintage look, as well.



CASE TRACTORS

TABLE OF CONTENTS

Spark Plug Wire Sets	74
Battery Cables	75
Wire Harnesses	76
Tune Up Parts for Battery Ignition	78
Electronic Ignition Conversion Kits	80
Tune Up Parts for Magneto Ignition	80
Replacement Magnetos	82
Gauges	83
Tachometer Drives	84
Switches	84
Starter Switches/Solenoids	86
Cutout Relays & Voltage Regulators	87
Brush Sets	87
Identification Tags	87
Alternators	88
Lights & Light Parts	88
Auxiliary Plugs & Sockets	91
Cigarette Lighters	91
Carburetor Rebuild Kits	91
Carburetor Floats	92
Carburetor Accessories	93
Fuel Sediment Bowls	93

SPARK PLUG WIRE SETS

Our Spark Plug Wire Sets Come Fully Assembled with the Proper Type Wire & Terminals.

They are Custom Tailored to Look & Fit Like Original Factory Equipment.

Varieties include:

Cotton Braid Wire: Copper Core with a Cotton Jacket.

PVC Wire: Copper Core with a Rubber Jacket.

EPDM Wire (E): Hi Performance Premium Conductor with a Tinned Copper Core, EPDM Silicone Insulation, and a Rubber Jacket.

Suppression Wire (S): for Electronic Ignition and is Spiral Wound, Ultra Low-Ohm, with EPDM Silicone Insulation and a Rubber Jacket.

Cotton Braid Suppression Wire (CS): also for Electronic Ignition, as Suppression Wire, but has an additional layer of Cotton Braid & Lacquer to replicate the vintage look, as well.



Case 10-18 & 10-20 Cross Motor with Magneto

4 Cyl. Tailored Spark Plug Wire Set

B1007-002	Original Type Cotton Braid Wire	\$32.25
B1007-002E	EPDM Wire	\$35.25

Case 12-20 Cross Motor with Magneto

4 Cyl. Tailored Spark Plug Wire Set

B1007-003	Original Type Cotton Braid Wire	\$32.25
B1007-003E	EPDM Wire	\$35.25

Case 18-32 Cross Motor with Magneto

4 Cyl. Tailored Spark Plug Wire Set

B1007-040	Original Type Cotton Braid Wire	\$32.25
B1007-040E	EPDM Wire	\$35.25

Case C with Magneto

(Note: For Replacement Distributor, Distributor Boots Are Included But Not Installed)

4 Cyl. Tailored Spark Plug Wire Set

B1007-039	Original Type Cotton Braid Wire	\$22.75
B1007-039E	EPDM Wire	\$24.50

Case CC with Magneto

(Note: For Replacement Distributor, Distributor Boots Are Included But Not Installed)

4 Cyl. Tailored Spark Plug Wire Set

B1007-004	Original Type Cotton Braid Wire	\$22.75
B1007-004E	EPDM Wire	\$24.50

Case D Series Case D, DC, DC3, DI, DO Tractors

4 Cyl. Tailored Spark Plug Wire Set

with Magneto

B1007-005	Original Type Cotton Braid Wire	\$22.75
B1007-005E	EPDM Wire	\$24.50

with Distributor

B1007-012	Original Type Cotton Braid Wire	\$22.75
B1007-012E	EPDM Wire	\$24.50
B1007-012S	Suppression Wire	\$24.50
B1007-012CS	Cotton Suppression Wire	\$39.00

Case L Series Case L, LA, LAH, LAI, LI w/ Magneto

4 Cyl. Tailored Spark Plug Wire Set

B1007-007	Original Type Cotton Braid Wire	\$27.25
B1007-007E	EPDM Wire	\$29.75

Case R Series Case R, RC Tractors with Magneto

4 Cyl. Tailored Spark Plug Wire Set

B1007-008	Original Type Cotton Braid Wire	\$28.75
B1007-008E	EPDM Wire	\$31.25

Case S Series Case S, SC, SI, SO Tractors

4 Cyl. Tailored Spark Plug Wire Set

Includes correct Case magneto boots & boots for other brands.

with Magneto

B1007-009	Original Type Cotton Braid Wire	\$28.75
B1007-009E	EPDM Wire	\$31.25

with Distributor

B1007-044	Original Type Cotton Braid Wire	\$28.75
B1007-044E	EPDM Wire	\$31.25
B1007-044S	Suppression Wire	\$31.25

Case V Series Case V, VC, VI, VO Tractors

4 Cyl. Tailored Spark Plug Wire Set

with Magneto

B1007-010	Original Type Cotton Braid Wire	\$22.75
B1007-010E	EPDM Wire	\$24.50

with Distributor

B1007-043	Original Type Cotton Braid Wire	\$26.00
B1007-043E	EPDM Wire	\$28.00

Case VA Series

Case VA, VAC, VAC-11, VAC-12, VAC-13, VAC-14, VAH, VAI, VAIW, VAO, VAO-15, VAS Tractors

4 Cyl. Tailored Spark Plug Wire Set
with Magneto

B1007-041	Original Type Cotton Braid Wire	\$22.75
B1007-041E	EPDM Wire	\$24.50

with Distributor

B1007-011	Original Type Cotton Braid Wire	\$22.75
B1007-011E	EPDM Wire	\$24.50
B1007-011S	Suppression Wire	\$24.50
B1007-011CS	Cotton Suppression Wire	\$39.00

Case 200, 300, 400 Series

Case 200, 200B, 210B, 211B, 300, 301, 310, 310B, 310C, 311, 311B, 312, 312B, 320, 350, 351, 400, 400B, 410, 411, 412, 413, 414, 415, 420, 420B, 425, 430, 431, 441, 470 Tractors

4 Cyl. Tailored Spark Plug Wire Set

B1007-016	Original Type PVC Wire	\$20.50
B1007-016E	EPDM Wire	\$24.50
B1007-016S	Suppression Wire	\$24.50

Case 500, 600, 700, 800 Series

Case 510B, 511B, 530, 530C, 531, 531C, 570, 610B, 611B, 614B, 630, 630C, 631, 631C, 680, 710B, 711B, 712B, 713B, 715, 730, 730CK, 741, 770, 800, 810, 810B, 811B, 812B, 813B, 830, 830C, 830CK, 840, 841, 870 Tractors

4 Cyl. Tailored Spark Plug Wire Set

B1007-017	Original Type PVC Wire	\$20.50
B1007-017E	EPDM Wire	\$24.50
B1007-017S	Suppression Wire	\$24.50

Case 970

6 Cyl. Tailored Spark Plug Wire Set

B1007-032	Original Type PVC Wire	\$32.50
B1007-032E	EPDM Wire	\$39.25
B1007-032S	Suppression Wire	\$39.25

BATTERY CABLES



Our Battery Cables are made from the Proper Gauge Copper, as either Black Cotton Braided Wire or PVC Wire (whichever is correct for the application), using Soldered & Heat Sealed Brass or Copper Terminals.

Case C Series

Case C, CC Tractors

B2007-001	Negative Battery Cable	\$31.50
B2007-002	Positive Battery Cable	\$39.50

Case D Series

Case D, DC, DC-3, DI, DO Tractors

B2007-001	Negative Battery Cable	\$31.50
B2007-002	Positive Battery Cable	\$39.50
B2007-005	Switch to Starter Cable	\$38.25

Case L Series Gas

B2000-007	Negative Ground Strap	\$14.50
B2007-015	Positive Battery Cable	\$32.75
B2007-055	Switch to Starter Cable	\$64.25

Case L Series LP

B2000-008	Negative Ground Strap	\$15.50
B2007-056	Positive Battery Cable	\$37.25
B2007-057	Switch to Starter Cable	\$73.25

Case R

B2000-004	Negative Ground Strap	\$10.50
B2007-002	Positive Battery Cable	\$39.50

Case S Series Case S, SC, SI, SO Tractors

B2000-007	Negative Ground Strap	\$14.50
B2007-017	Positive Battery Cable	\$34.50
B2007-018	Switch to Starter Cable	\$39.75

Case V Series (Up to Serial #556,999)

Case V, VA, VAC, VC, VI, VO, Tractors

B2000-007	Negative Ground Strap	\$14.50
B2007-023	Positive Battery Cable	\$22.75
B2007-025	Switch to Starter Cable	\$40.50

Case V Series (Serial #557,000 & Up)

Case V, VA, VAC, VC, VI, VO, Tractors

B2000-007	Negative Ground Strap	\$14.50
B2007-026	Positive Battery Cable	\$22.50
B2007-028	Switch to Starter Cable	\$43.25

Case 200, 300

B2000-007	Negative Ground Strap	\$14.50
B2007-035	Positive Battery Cable	\$35.00

Case 400

B2000-007	Negative Ground Strap	\$14.50
B2007-037	Positive Battery Cable	\$31.25

Case 530 Gas

B2000-007	Negative Ground Strap	\$14.50
B2007-035	Positive Battery Cable	\$35.00

Case 530 Diesel

B2000-007	Negative Ground Strap	\$14.50
B2007-039	Positive Battery Cable	\$50.75
B2007-063	Battery to Battery Jumper Cable	\$23.75

Case 580 Gas

B2000-007	Negative Ground Strap	\$14.50
B2007-040	Positive Battery Cable	\$44.75

Case 580B Diesel

B2000-007	Negative Ground Strap	\$14.50
B2007-049	Positive Battery Cable	\$57.25

Case 580C Diesel

B2000-007	Negative Ground Strap	\$14.50
B2007-062	Positive Battery Cable	\$69.25

Case 630, 730, 830 (Gas)

B2007-041	Negative Battery Cable	\$28.50
B2007-035	Positive Battery Cable	\$35.00

Case 630 Diesel

B2000-007	Negative Ground Strap	\$14.50
B2007-044	Positive Battery Cable	\$50.50
B2007-063	Battery to Battery Jumper Cable	\$23.75

Case 730 Diesel, 830 Diesel

B2007-047	Negative Battery Cable	\$44.00
B2007-048	Positive Battery Cable	\$34.50
B2007-063	Battery to Battery Jumper Cable	\$23.75

Case 830 Gas

B2007-064	Battery to Battery Jumper Cable	\$41.75
------------------	---------------------------------	----------------

Case 900 Diesel

B2007-058	Negative Battery Cable	\$34.50
B2007-059	Positive Battery Cable	\$50.50
B2007-060	Battery to Battery Jumper Cable	\$51.50

Case 930 Diesel

B2007-047	Negative Battery Cable	\$44.00
B2007-044	Positive Battery Cable	\$50.50
B2007-061	Battery to Battery Jumper Cable	\$61.25

Case 1160 Combine

B2000-009	Negative Ground Strap	\$14.50
B2007-040	Positive Battery Cable	\$44.75



WIRING HARNESSSES

Our Wire Harnesses are made with our **premium cotton braid and/or PVC wire**.

They have the **correct gauge, color, wire, & fuse holders** (if needed).

All terminals are **soldered according to the original**.

(Harnesses do not include Battery Cables & Spark Plug Wires; however, we can supply these as separate products.)

NO HIDDEN COSTS, NOTHING EXTRA TO BUY!

Case D, DC, DC-3, DI (Up To Serial #4,511,448)

B3007-001	Complete Wire Harness Original Design with Generator & Cut out Relay	Replaces Case: #O5221AB, O5222AB, O5043AB, O5558AB	\$151.50
------------------	--	---	-----------------

Case D, DC, DC-3, DI (Serial #4,511,449 & Up)

Complete Wire Harness

B3007-002	Original Design with Generator & Voltage Regulator	Replaces Case: #O5043AB, O5222AB1, O5558AB, O7201AB, O7202AB	\$151.50
B3007-015	Modified for 1 Wire Alternator	See #B3007-002	\$151.50

Case DO (Up To Serial #4,511,448)

B3007-005	Complete Wire Harness Original Design with Generator & Cut out Relay	Replaces Case: #O5046AB, O4605AB, O5055AB, O5492AB, O7202AB	\$151.50
------------------	--	--	-----------------

Case DO (Serial #4,511,449 to 5,600,000)

B3007-006	Complete Wire Harness Original Design with Generator & Voltage Regulator	Replaces Case: #O5046AB, O4605AB, O5055AB, O7201AB, O7202AB	\$151.50
------------------	--	--	-----------------

Case S, SC, SI (Up To Serial #5,599,999)

Complete Wire Harness

B3007-009	Original Design with Generator & Voltage Regulator	Replaces Case: #O6355AB, O6356AB, O6357AB, O6358AB, O6359AB, O6360AB	\$151.50
B3007-023	Modified for 1 Wire Alternator	See #B3007-009	\$151.50

Case S, SC, SI (Serial #5,600,000 & Up)

B3007-010	Complete Wire Harness Original Design with Generator	Replaces Case: #O6355AB, O6356AB, O6357AB, O6358AB, O6359AB, O7295AB	\$151.50
------------------	--	---	-----------------

Case VA, VAC (Up to Serial #557,000)

Complete Wire Harness

B3007-013	Original Design with Generator & Cutout Relay		\$159.75
B3007-035	Modified For Generator & Voltage Regulator		\$159.75
B3007-034	Modified For 1 Wire Alternator		\$159.75
B3007-030	Modified For Delco 10SI (3 Wire) Alternator		\$159.75

Case VA, VAC (Serial #557,001 & Up)

Complete Wire Harness

B3007-016	Original Design with Generator & Voltage Regulator		\$145.50
B3007-027	Modified for 1 Wire Alternator		\$145.50

Case 200, 300, 350, 400 Series Gas Tractors

Complete Wire Harness

B3007-021	With Individual Gauges & Generator	Replaces Case: #G13085, G13158, G13159, G13160, G13162, G13163, G13164, G13169	\$213.25
B3007-032	With Individual Gauges, Modified for 1 Wire Alternator	See #B3007-021	\$213.25
B3007-019	With Cluster Gauges & Generator		\$263.25
B3007-022	With Cluster Gauges, Modified For Delco 10SI Alternator		\$263.25

Case 430 Gas (Serial #8,262,800 to 8,297,800)

Complete Wire Harness

B3007-031	Original Design with Generator	Replaces Case: #A36676, G44060, G44061 Main Engine Harness, #A11943 Headlamp to Harness Lead, #A11764 Headlamp to Headlamp Lead, #A33439 Headlamp to Ground Lead (2 Used), #A36554 Tail Lamp to Harness Lead, #G13085 Coil to Distributor Lead, #A2485 Generator Warning Lamp Base, #A24084 Engine Oil Pressure Warning Lamp Base, #A24078 Temperature Gauge to Ignition Switch Lead, #A22874 Fuse Holder, #A10958 Fuse Holder Cap, #A22876 Fuse Holder to Ignition Switch Lead, #A22875 Fuse Holder to Light Switch Lead; #A24076, #A21613 Dash Wire Harness	\$343.50
------------------	--------------------------------	--	-----------------

Case 430 Gas (All Other Serial Numbers)

B3007-024	Lighting Harness	Replaces Case: G44048	\$94.50
------------------	-------------------------	------------------------------	----------------

Case 530, 630 Gas with Autolite Gauges (Up to Serial #8,262,800)

Complete Wire Harness

B3007-025	Original Design with Generator & Autolite Gauges		\$317.75
B3007-038	Modified for a 1 Wire Alternator		\$317.75
B3007-040	Modified for Delco 10SI Alternator		\$317.75

Includes Listed Components Below and Can Be Purchased Separately

Dash & Engine Harness

B3007-026	Original Design with Generator & Autolite Gauges	Replaces Case: #A35304, G44060, G44061, G44063 Engine Harness, #G44062 Dash Harness, #G44066 Neutral Safety Switch Harness, #G13085 Coil to Distributor Lead	\$223.50
B3007-037	Modified for 1 Wire Alternator	See B3007-026	\$223.50
B3007-039	Modified for Delco 10SI Alternator	See B3007-026	\$223.50
B3007-024	Lighting Harness	Replaces Case: #G44048	\$ 94.50

Case 730 Comfort King Gas (W/O Cab) Serial # 8253501 & Up (Jan 1965 to Dec 1969)

Complete Wire Harness

B3007-029	Original Design with Generator	Replaces Case: #A11764 Head Light to Head Light Lead, #A11943 Harness Connector to Head Light Lead, #A22879 Resistor Lead, #A21613 Dash Harness, #A24076 Dash Harness, #A34864 Engine Harness, #A32534 Engine Temp Switch Lead, #A33439 Head Light to Ground Lead	\$506.50
B3007-036	Modified For Delco 10SI Alternator	See #B3007-029 Note: Can Be Used With 1 Wire Alternator Except Charge Indicator Lamp Will Not Work!	\$506.50

Case 830 Comfort King Gas (W/O Cab) Serial # 8253501 & Up (Jan 1965 to Dec 1969)

Complete Wire Harness

B3007-029	Original Design with Generator	Replaces Case: #A11764 Head Light to Head Light Lead, #A11943 Harness Connector to Head Light Lead, #A22879 Resistor Lead, #A21613 Dash Harness, #A24076 Dash Harness, #A34864 Engine Harness, #A32534 Engine Temp Switch Lead, #A33439 Head Light to Ground Lead	\$506.50
B3007-036	Modified For Delco 10SI Alternator	See #B3007-029 Note: Can Be Used With 1 Wire Alternator Except Charge Indicator Lamp Will Not Work!	\$506.50

Case 930 Comfort King Diesel (W/O Cab) Serial #8253501 & Up (Jan 1965 to Dec 1969)

Complete Wire Harness

B3007-028	Original Design with Generator	Replaces Case: #A34820 Engine Harness, #A24076, A21613 Dash Harness	\$536.75
B3007-033	Modified For Delco 10SI Alternator	Replaces Case: #A34820 Engine Harness, #A24076, A21613 Dash Harness	\$536.75

Note

When ordering, please specify **Year** or **Serial Number**, Magneto/Distributor, & Regulator/Cut Out Relay.
Some Harnesses were originally made with PVC Wire & Braided; others were made with PVC Wire & Taped.
In those cases, we build them the **Original Way**.



Tune Up Parts For Battery Ignition

Case D, DI, DO, 200, 200B, 210, 210B, 211B, 300, 300B, 310, 320, 350, 351, 400, 400B, 420, 430, 435LCK, 440, 441, 450, 500 All With Delco Distributor		
	B4100-001	\$10.50
	PCR Kit Includes: Points (#B4001-001), Condenser (#B4002-001), Rotor (#B4004-002) Replaces: Points - #D100HP, 1855720 Condenser - #1928111, D-203, 1869704, D-200 Rotor - #820445, D400	
	B4004-002	\$5.75
	Rotor Replaces: #820445, D400	
	B4003-001	\$13.50
	Distributor Cap Premium Grade, Made in the USA (Brass Contacts) Replaces: #811735, D300	
	B4006-001	\$9.99
	Dust Cover Replaces: #1900119	
	B4007-001	\$11.95
	Cap Clip Short Mount, 1 Used Replaces: #1889967, 1847289, 453844, 453461	
	B4007-002	\$11.95
	Cap Clip Long Mount, 1 Used Replaces: #1889967, 1889999, 453844, 453461	
	B4008-001	\$14.99
	Distributor Insulator Replaces: #1904376	
	B4009-001	\$25.99
	Distributor Bushing & Shim Kit	

*For 6- or 12-Volt Ignition Coils & Accessories, see p.44

Case S, VA, VAC, VAI, 200, 200B, 210, 210B, 211B, 300, 300B, 310, 320, 350, 351, 400, 400B, 420, 430, 435LCK, 440, 441, 450, 470, 500, 500B, 530, 535LCK, 540, 540C, 541, 541C, 570, 580, 580CK, 580CK-B, 600B, 600G30, 640, 640C, 641, 641C, 700B, 800, 800B, 900LPG, 900B with Autolite/Prestolite Distributor #IAD-4101A, IAD-6003		
B4100-004		\$14.75
	PCR Kit Includes: Points (#B4001-005), Condenser (#B4002-002), Rotor (#B4004-003) Replaces: Points - #1-4, 1-8, 1-9, 1-20, 1-22, 1-45, IAD-3128S, IGP-3028ES, IGP3028FS, IGS2224L, IGW3028AS Condenser - #2-23, 2-31, 2-32, 2-34, 2-38, 2-42, IAT-2015L, IAT-2015R, IAT-3076AS, IAT-3076BS, IAT-3076D, IAT-3076DS, IAT-3076L, IAT-3076LA, IAT-3076R, IAT-3076RA, IBB-2015L, IBB-2015R, IBB-2042-SS, IBB-2042SS-1, IBB-2042-SS3, IG-2671F, IGH-3076, IGW-3139, 2098058, 3420600 Rotor - #4-10	
	B4004-003	\$5.25
	Rotor Premium Grade, Made in USA Replaces: #4-10	
	B4003-003	\$21.00
	Distributor Cap Made in the USA (Brass Contacts) Replaces: #IG-1324D, 3-11, 3-12	

*For 6- or 12-Volt Ignition Coils & Accessories, see p.44

Case V, VC, VI, VO with Continental Engine		
	B4001-002	\$14.75
	Points Replaces: #IGW-3028S, 1-31	
	B4002-005	\$9.75
	Condenser Replaces: #2-24, 2-35, 2-22, 2-23	
	B4004-004	\$11.50
	Rotor Premium Grade, Made in the USA Replaces: #4-15, IGB-1239	
	B4003-004	\$14.50
	Distributor Cap Premium Grade, Made in the USA (Brass Contacts) Replaces: #IGB-1241, IGB1241A, 3-21, 3-22	

*For 6-Volt Ignition Coils & Accessories, see p.44

Case 4 Cyl. 470, 500, 500B, 530, 535LCK, 540, 540C, 541, 541C, 570, 580, 580CK, 580CK-B, 680CK, 641, 730, 734, 740, 770, 830, 840, 870 with Autolite/Prestolite Distributor #IBT-4402, IBT-4403		
	B4001-008	\$4.75
Points Replaces: #IBP-2040R, IBP-3028AS, 1-32, 1-46		
	B4002-006	\$7.50
Condenser Replaces: #2-31, 2-38, 2-42, 2-95, IAT-1125S, IAT-3076BS, IBB-2042SS-1, IBB-2042-SS3, IG-3927F, IG-3927G, IG-3927K, IG-3927R,		
	B4004-005	\$7.25
Rotor Premium Grade, Made in the USA Replaces: #IBT-1016, IAU-1104, 4-26, 4-28		
	B4003-005	\$18.25
Distributor Cap Premium Grade, Made in the USA (Brass Contacts) Replaces: #IBT-1003B, IBT-1003C, IBT-4702, 3-133, 3-123		
	B4006-007	\$16.75
Dust Cover Replaces: #31-267, IBT-1059B		

*For 6- or 12-Volt Ignition Coils & Accessories, see p.44

Case 700, 800 Series Gas with WICO Distributor Type DB		
	B4001-003	\$16.75
Points Replaces: #1-5032		
	B4002-007	\$7.00
Condenser Replaces: #2-5094		
	B4003-006	\$25.50
Cap Replaces: #3-5059		
	B4004-006	\$7.25
Rotor Replaces: #4-5017		

*For 12-Volt Ignition Coils & Accessories, see p.44

Case WICO Distributor #DBX-30170		
	B4001-003	\$16.75
Points Replaces: #1-5032		
	B4002-007	\$7.00
Condenser Replaces: #2-5094		
	B4003-064	\$34.75
Cap Replaces: #3-5061		
	B4004-006	\$7.25
Rotor Replaces: #4-5017		

*For 12-Volt Ignition Coils & Accessories, see p.44

Case 970 w/ 377BG, A401 (Autolite/Prestolite Distributor), W8C, W9C, W10C Loaders (Eng. 377; Distributor #IBT-6404A), & W7G Loader (Eng. A-284; Distributor #IBT-6404)		
	B4001-008	\$4.75
Points Replaces: #IBP-2040R, IBP-3028AS, 1-32, 1-46		
	B4002-006	\$7.50
Condenser Replaces: #2-31, 2-38, 2-42, 2-95, IAT-1125S, IAT-3076BS, IBB-2042SS-1, IBB-2042-SS3, IG-3927F, IG-3927G, IG-3927K, IG-3927R,		
	B4004-005	\$7.25
Rotor Premium Grade, Made in the USA Replaces: #IBT-1016, IAU-1104, 4-26, 4-28		
	B4003-066	\$12.75
Distributor Cap Premium Grade, Made in the USA Replaces: #IBT-1030C, D		
	B4006-007	\$16.75
Dust Cover Replaces: #31-267, AT14682, IBT-1059B		

*For 6- or 12-Volt Ignition Coils & Accessories, see p.44

ELECTRONIC IGNITION CONVERSION KITS

Replaces Points & Condenser



Case S, VA, VAC, VAI, 200, 200B, 210, 210B, 211B, 300, 300B, 310, 320, 350, 351, 400, 400B, 420, 430, 435LCK, 440, 441, 450, 470, 500, 500B, 530, 535LCK, 540, 540C, 541, 541C, 570, 580, 580CK, 580CK-B, 600B, 600G30, 640, 640C, 641, 641C, 700B, 800, 800B, 900LPG, 900B
with Autolite/Prestolite Distributor #IAD-4101A, IAD-6003

B9600-057	12 Volt Negative Ground	\$129.95
B9600-057P12	12 Volt Positive Ground	\$147.45
B9600-057N6	6 Volt Negative Ground	\$147.45
B9600-057P6	6 Volt Positive Ground	\$147.45

Case 4 Cyl. 470, 500, 500B, 530, 535LCK, 540, 540C, 541, 541C, 570, 580, 580CK, 580CK-B, 680CK, 641, 730, 734, 740, 770, 830, 840, 870
with Autolite/Prestolite Distributor # IBT-4402, IBT-4403

B9600-058	12 Volt Negative Ground	\$134.45
B9600-058P12	12 Volt Positive Ground	\$147.45
B9600-058P6	6 Volt Positive Ground	\$147.45

Case 4 Cyl. 800 with WICO DB / DBX Distributor

B9600-224	12 Volt Negative Ground	\$169.45
------------------	-------------------------	-----------------

Case 6 Cyl. 900 with Autolite Distributor only

B9600-064	12 Volt Negative Ground	\$134.45
B9600-064P12	12 Volt Positive Ground	\$147.45

Case 4 Cyl. 1830 Skid Steer with Ducellier Distributor

B9600-313LS	12 Volt Negative Ground	\$149.45
--------------------	-------------------------	-----------------



***For Ignition Coils & Accessories, see p.44**

TUNE UP PARTS FOR MAGNETO IGNITION

Case A, A12-21, C, CB, CC, CE, CH, CI, CO, D, DC, DE, DI, DO, K, K12, K18-32, L, LA, LE, LI, L26-40, R, RC, RI, S, SC, SI, SO, T25-45, V, VAC, VAE, VAI, VAO with Fairbanks Morse Magneto #FMJ-4A9

	B4110-004	\$33.95
	PCR Kit Includes: Points (#B4011-002), Condenser (#B4012-001), Rotor (#B4014-001) Replaces: Points - #R2437 Condenser - #AXMR2433 Rotor - #M2765	
	B4013-001	\$49.75
	Cap Replaces: #C800	
	B4013-002	\$49.75
	Cap (Inner) Replaces: #A2430C	
	B4015-002	\$39.75
	Coil Replaces: #R2477C	
	B4016-001	\$2.75
	Cap Gasket (Outer) Replaces: #B682	
	B4016-002	\$2.75
	Cap Gasket (Inner) Replaces: #H2498	
	B4016-003	\$14.75
	Complete Gasket Set Includes # H2498 (B4016-002), B682 (B4016-001), G2501, G3861, A2492A, Replaces: #GK17	
	B4016-005	\$1.75
	Flange Gasket Replaces: #SAE	
	B4017-036	\$14.75
	Distributor Shaft and Gear Replaces: #N5939	

	B4017-037 Rotor Pinion Gear Replaces: #F5952	\$21.25
	B4017-001 Coil Lead Replaces: #FMJL	\$2.75
	B4017-062 High Tension Rod Replaces: J983A	\$12.75
	B4017-002 Rear Ball Bearing Replaces: #C5949	\$11.75



B4017-058	FMJ Distributor Shaft Clip	\$2.25
B4017-059	FMJ Distributor Shaft Washer	\$2.25
B4017-060	FMJ Distributor Shaft Felt Seal	\$1.75

Case with Fairbanks-Morse Magneto #FM-X4A9, FM-X4A16, FM-4A17, FM-X4BA, FM-X4B9A, FM-X4B9C

	B4011-003 Points Replaces: #A2437A	\$18.50
	B4012-001 Condenser Replaces: #AXMR2433	\$11.00
	B4013-001 Cap Replaces: #C800	\$49.75
	B4014-001 Rotor Replaces: #M2765	\$10.50
	B4013-003 Cap (Inner) Replaces: #AZ2430C	\$38.75
	B4015-002 Coil Replaces: #R2477C	\$39.75



	B4016-001 Cap Gasket (Outer) Replaces: #B682	\$2.75
	B4016-002 Cap Gasket (Inner) Replaces: #H2498	\$2.75
	B4016-003 Complete Gasket Set Includes # H2498 (B4016-002), B682 (B4016-001), G2501, G3861, A2492A, Replaces: #GK17	\$14.75
	B4016-005 Flange Gasket Replaces: #SAE	\$1.75
	B4017-001 Coil Lead Replaces: #FMJL	\$2.75
	B4017-002 Rear Ball Bearing Replaces: #C5949	\$11.75
	B4017-041 Coupling Impulse Spring Replaces: #D2565	\$16.00
	B4017-050 High Tension Rod Replaces: A983A	\$12.75





Case with WICO Magnetos #X184, XH184, XH894, XH1950, XH2239, XH2500

	B4011-004 Points Replaces: #1-5008, 1-5111, FXH-2100B, FXH-2400B, X5996	\$17.75
	B4012-002 Condenser Replaces: #2-5007, X5614, X6916	\$13.75
	B4017-040 Condenser Clamp Replaces: #94-5167	\$2.75

	B4013-004	\$36.75
	Cap Includes #B4016-004 Replaces: #3-5014	
	B4014-002	\$23.50
	Rotor Replaces: #4-5010	
	B4016-004	\$2.25
	Cap Gasket Replaces: #94-5076	
	B4017-031	\$44.00
	Drive Cup Replaces: #94-5359	
	B4017-005	\$3.50
	Inner Bearing Replaces: #24-5000	
	B4017-006	\$9.75
	Outer Bearing Replaces: #25-5000	
	B4017-007	\$12.50
	Impulse Spring Replaces: #94-5016	
	B4017-046	\$2.75
	Bearing Cage Snap Ring Replaces: #43-5055	
	B4016-012	\$2.25
	Striker Plate Gasket Replaces: #94-5154	
	B9013-011	\$7.00
	WICO Series X Nameplate Fits the WICO Series X magneto (Rivets included)	

Case with WICO Magneto (#XHD2700)

	B4011-004	\$17.75
	Points Replaces: #1-5008, 1-5111, FXH-2100B, FXH-2400B, X5996	
	B4017-007	\$12.50
	Impulse Spring Replaces: #94-5016	
	B4016-012	\$2.25
	Striker Plate Gasket Replaces: #94-5154	

Case with American Bosch Magneto #MRD-4A		
	B4011-007	\$25.75
	Points Replaces: #BK52203	
	B4012-003	\$18.50
	Condenser Replaces: #CW5279	
	B4015-015	\$69.25
	Coil Replaces: #SM137	
	B4013-033	\$64.50
	Cap Replaces #DP52607, DP52610	
	B4014-013	\$15.75
	Rotor Replaces: #RT52288	
	B4016-013	\$5.75
	Cap Gasket Replaces: #GA5261	

REPLACEMENT MAGNETOS

Our Rebuilt Magnetos are completely torn down, cleaned, & inspected. They will (at the minimum) have the following new parts: Points, Condenser, Coil, Coil Insulators, Lead-out Tower, & Outside Covers, plus any additional parts that are needed to make the unit look & perform like new.

They come with a 1-Year Limited Warranty.

Notes:

1. Unless otherwise specified, cost is exchange price.
2. A core charge (see below) will be charged to your credit card until we receive your good core.
3. A good core is considered a complete magneto with no cracks or weld repairs. Only good cores will be credited.

*Magnetos must be used with copper ignition wire.

Use of any other type will Void the Warranty.*

	XH184R	Exchange	\$445.00
		Outright	\$645.00
Rebuilt WICO Magneto 4 Cyl. Base Mount Core Charge: \$200			

	XH894R	Exchange	\$445.00
		Outright	\$645.00
Rebuilt WICO Magneto 4 Cyl. Flange Mount Core Charge: \$200			

GAUGES

Ammeters, Universal

B9025-002	Ammeter 20-0-20	\$19.99
	Does not have a logo Dimensions: Fits in 2" Diameter Hole 1.850" From Post to Bottom of Bezel	
B9025-005	Ammeter 30-0-30	\$19.99
	Does not have a logo Case Replaces: 10860, O3601AB1, R18748 Fits: [420C, 310, 1000 (Crawler)], C, CC, CC-3, CC-4, CCS, CH, CI, CO, D, DC, DC-3, DC-4, DCS, DH, DI, DO, DV, L, LA, LAH, LAI, LAIH, LAIM, LI, RC, S, SC, SC-3, SC-4, SI, SO, V, VA, VAC, VAC-11, VAC-12, VAC-13, VAC-14, VAE, VAH, VAI, VAO, VC, VI, VO, 400, 401, 402, 403, 405, 410, 411, 412, 413, 414, 415, 420, 425; Industrial: W9	
B9025-008	Ammeter 60-0-60	\$19.99
	Does not have a logo Uses threaded terminals and is dash mounted Used with 12-Volt Alternator Systems Dimensions: Fits in 2" Diameter Hole Measures 1.765" from Top of Post to Bottom of Bezel	
B9025-095	Case Ammeter 20-0-20	\$31.99
	Includes CASE Logo, Chrome Bezel. For 2" diameter hole. Case Replaces: #O3601AB, O3601AB1 Fits: C, CC, CI, CO, D, DC, DC-3, DC-4, DCS, DH, DI, DO, DV, L, LA, LAI, R, RC, S, SC, SC-3, SC-4, SI, SO, V, VAC, VAC-11, VAC-12, VAC-13, VAC-14, VAH, VAIW, VAIW-3, VAO, VAO-15, VC, VO, 400, 500	

Oil Pressure Gauges

B9025-004	Universal Oil Pressure Gauge (0-50 PSI)	\$21.99
	Dash mounted, requires 2" diameter hole. Has 1/8" NPT Male Threads, studs & a bracket. Does not have a logo Case Fits: 200B, 210B, 211B, C, CC, CC-3, CC-4, CCS, CH, CI, CO, D, DC, DC-3, DC-4, DCS, DEX, DH, DI, DO, DV, L, LA, LAH, LAI, LI, R, RC, S, SC, SC-3, SC-4, SI, SO, V, VA, VAC, VAC-11, VAC-12, VAC-13, VAC-14, VAE, VAH, VAI, VAIW, VAIW-3, VAO, VAO-15, VAS, VC, VI, VO, 310B, 310C, 310D, 310E, 310F, 310G, 310, 420C	
B9025-001	Universal Oil Pressure Gauge (0-80 PSI)	\$24.99
	Dash mounted, requires 2" diameter hole. Has 1/8" NPT Male Threads, studs & a bracket. No logo included. Case Replaces: A19346 Fits: C, CC, CC-3, CC-4, CCS, CH, CI, CO, D, DC, DC-3, DC-4, DCS, DEX, DH, DI, DO, DV, L, LA, LAH, LAI, LI, R, RC, S, SC, SC-3, SC-4, SI, SO, W10B, W10C, W10E, W10E, W14, W14H, W18, W20, W24, W24B, W26, W26B, W7, W7C, W7E, W8B, W8C, W8E, W9, W9B, W9C, W9E, 400, 401, 402, 403, 405, 410, 411, 412, 413, 414, 415, 420, 425, 500, 520, 600, 610, 620 (& others using 80 Lb. Gauge)	
B9025-094	Case Oil Pressure Gauge (0-60 PSI)	\$31.99
	Includes CASE Logo, Chrome bezel, Dash- or bracket-mounted, Includes bracket and studs (1/8" NPT), 1/8" male pipe threads, For 2" diameter hole Case Replaces: - #A31169, O4370AB Fits - C, CC, CI, CO, D, DC, DC-3, DC-4, DCS, DH, DI, DO, DV, L, LA, LAI, R, RC, S, SC, SC-3, SC-4, SI, SO, 400, 500	
Oil Pressure Gauge, Line Kit		
B9026-001	Oil Pressure Gauge Line Kit	\$29.99
	6 FT copper 1/8" line - Kit includes: (2) 5/16 - 24 UNF nut, (2) compression sleeves, (1) 1/8 - 27 NPTF female to 5/16" - 24 UNF male adapter. Note: Depending on application customer may be required to purchase other fittings.	
B9026-004	Oil Pressure Gauge 1/4" to 1/8" NPT Adapter Fitting	\$15.99
	Adapter Fitting for Oil Gauges - 1/4" to 1/8" NPT. Case Fits: C, CC, D, DC, DI, DO, L, LA, LAI, R, RC, S, SC, SI, SO, V, VAC, VAH, VAI, VAO, VC, VO, 1030, 200B, 210B, 211B, 300B, 310B, 311B, 320, 320B, 400B, 411B, 420B, 430, 470, 480, 500B, 511B, 530, 540, 570, 600B, 611B, 630, 640, 700, 730, 740, 830, 840, 930 (w/mechanical gauge)	

Water Temperature Gauges, Universal

B9025-006	Water Temperature Gauge	\$34.99
	Includes an Aluminum Sealing Washer to Seal Probe. Has White, Green, Red Zones, 1/2" NPT Pipe Bushing, Probe Length of 1.279". Case Fits: C, CC, CC-3, CC-4, CCS, CH, CI, CO, D, DC, DC-3, DC-4, DCS, DEX, DH, DI, DO, DV, S, SC, SC-3, SC-4, SI, SO, V, VA, VAC, VAC-11, VAC-12, VAC-13, VAC-14, VAE, VAH, VAI, VAIW, VAIW-3, VAO, VAO-15, VAS, VC, VI, VO, 200B, 210B, 211B, 400, 401, 402, 403, 405, 410, 411, 412, 413, 414, 415, 420 (And Other Models Using 60" Capillary Lead) Crawler: 310, 310C, 310D, 310E, 310F, 310G, 420C	

B9025-007	Universal Water Temperature Gauge	\$34.99
	Dash-mounted (parts included), 72" long heavy duty capillary tube included (check length before ordering) Case Fits: C, CC, CC-3, CC-4, CCS, CH, CI, CO, D, DC, DC-3, DC-4, DCS, DEX, DH, DI, DO, DV, L, LA, LAH, LAI, LI, S, SC, SC-3, SC-4, SI, SO, Super 400, V, VA, VAC, VAC-11, VAC-12, VAC-13, VAC-14, VAE, VAH, VAI, VAIW, VAIW-3, VAO, VAO-15, VAS, VC, VI, VO, 200, 200B, 210, 210B, 211, 211B, 310C, 400, 401, 402, 403, 405, 410, 411, 412, 413, 414, 415, 420 (And Others Using 72" Or Shorter Capillary Lead) Crawler: 310, 310D, 310E, 310F, 310G, 420C	

Water Temperature Gauges, Case

B9025-072	Case Water Temperature Gauge	\$31.99
	100° F to 220° F Temperature Range. 60" Capillary Lead with 5/8" – 18 UNF End and 1/2" NPT Pipe Bushing. Fits in a 2" Diameter Hole. Case Replaces: #VT2265 Fits: C, CC, CC-3, CC-4, CCS, CH, CI, CO, D, DC, DC-3, DC-4, DCS, DH, DI, DO, DV, S, SC, SC-3, SC-4, SI, SO, V, VA, VA, VAC, VAC-11, VAC-12, VAC-13, VAC-14, VAH, VAI, VAO, VAS, VC, VO; Industrial: VI, Newer Case Models without Cluster Gauge	

Tachometer Drives

B9035-001	Tachometer Drive Assembly	\$46.50
	Has a 14 Tooth to 43 Tooth Gear Ratio. Includes Gaskets. Case Fits: 430, 430CK, 431, 435, 441, 445, 470, 480, 480CK, 530, 530CK, 530 Construction King, 531, 535, 540, 541, 545, 570, 580, 580CK, 580 Construction King, 630, 631, 632, 634, 640, 641, 642, 644 (Some, Gas / Dsl (When driven off the generator w/ 14/43 teeth)	

Tachometer Drive Cable

B9026-008	38 7/8" Tachometer Drive Cable	\$20.99
	Measures 38 7/8" long with a metal sheath. Has square ends with 5/8" – 18 x 7/8" – 18 threads. Case Replaces: #G13022, G13023, G45393 Fits (4 cyl. Gas/LP): 200, 200B, 210, 210B, 211, 211B, 300, 300B, 310B, 311, 311B, 312, 312B, 350, 351, 400B, 410B, 411B, 500B, 510B, 511B, 600B, 610B, 611B, 614B Industrials: 310 Crawler, 420B	

SWITCHES & KNOBS

B5001-009	Combo Light Switch Knob	\$6.99
	Fits #B9017-010, B9016-018, B9016-032, B9016-033. Also fits original equipment combo rear lights when 'handle' style knob is required. Case Replaces: #B50310 Fits: D, DC, DC-3, DC-4, DCS, DEX, DH, DI, DO, DV, LA, LAH, LAI, S, SC, SC-3, SC-4, SI, SO, W3, 1030 (& CK, DOM), 1031, 1032, 200, 200B, 210, 210B, 211, 211B, 300, 300B, 301, 301B, 302, 302B, 310, 310B, 311, 311B, 312, 312B, 320, 320B, 350, 350B, 351, 400, 400B, 401, 402, 403, 405, 410, 410B, 411, 411B, 412, 413, 414, 415, 420, 420B, 420BD, 425, 430 (& CK), 431, 435, 440, 441, 445, 470, 480 (& B, CK), 500, 500B, 510, 510B, 511, 511B, 520, 525, 530 (& CK), 531, 535, 540, 541, 545, 570, 580 (& B, CK), 600, 600B, 611, 611B, 614, 614B, 620, 630, 631, 632, 634, 640, 641, 642, 644, 700, 700B, 701, 701B, 702, 702B, 703, 703B, 705, 705B, 710, 710B, 711, 711B, 712, 712B, 713, 713B, 715, 715B, 730 (& CK, DOM) 731, 732, 733, 734, 740, 741, 742, 743, 744, 800, 800B, 801, 801B, 802, 802B, 803, 803B, 805B, 810, 810B, 811, 811B, 812, 812B, 813, 813B, 815, 815B, 830, 830 (& CK, DOM), 831, 832, 833, 840, 841, 842, 843, 900, 900B, 910, 910B, 920, 920B, 930 (& CK, DOM), 931, 932, 940, 941	

B5011-002	Light Switch Resistor	\$15.99
	Used on all Models with Cut Out Relay & Original Delco 4-Position Light Switch Replaces Case - #VTA463 Delco - #1838155, 1882994, 1878070 Fits Case (for switch #VTA463 on models up to SN: 5,060,679) - VA, VAC, VAH, VAI, VAO	

Push/Pull Switches

B5002-001	2-Position Push/Pull Switch	\$7.75
	OFF/ON Universal 2 Position Push/Pull 2 Screw Terminals Mounting Stem 3/8"-32 Thread Knob #10/32 Thread	

B5002-005	3-Position Push/ Pull Switch	\$29.75
	Low Charge/High Charge/Lights (3 Position Switch), 3 Screw Type Mounting Stem .8" Thread Knob #10/32 Thread Premium Quality Made by an OEM Manufacturer Case Replaces: #VTA463 Fits (Up To Serial #5,060,679 With Cut Out On Generator): VA, VAC, VAC-11, VAC-12, VAC-13, VAC-14, VAH, VAI, VAO, VAS	

B5002-004	Heavy Duty Push/Pull Magneto Switch	\$8.25
	ON/OFF (2-Position) Push/Pull Magneto Switch (2 Screw Terminals) Mounting Stem 3/8"-32 Thread Knob #10/32 Thread	

Key Switches

B5003-001	2-Position Battery Key Switch	\$14.75
	Universal OFF/ON 2 Position Key Switch (For Battery Ignition) (2 Screw Terminals) Mounting Stem 3/4"-20 Thread	

B5003-017	4-Position Ignition Key Switch	\$16.99
	Has a Total of 6 Spade Terminals: 2 are .375" Wide and the other 4 are .250" Wide. The threaded end is .625" Replaces: Delco - #1533514 Case - #3107556R92, 3107556R93, K203992, K912384, K920293, K920923, K929365, K945294 Fits: Case - 1190, 1194, 1210, 1212, 1290, 1390, 1394, 1410, 1412, 1490, 1494, 1594, 1690, 1694, 885, 996	

B5003-005	4-Position Ignition Key Switch	\$39.99
	Can replace the 4 terminal switch. 2 battery terminals, 5 Spade Terminals, OEM Style Delco Remy .995" Diameter Threaded End. Includes 2 Keys & Jam Nut Case Replaces: D75657, L17820, A11373 Fits: 780B, 780C, W10A, W10C, 700, 800, 900, Industrial: 310E, 310F, 310G, 680B, 680C, 680CK, 780, W10, W10B, W10E, W12, W26, W5, W5A, W7, W7C, W7E, W9, W9A	

B5003-006	Ignition Key	\$4.99
	Key for Part Above: #B5003-005. Brass Finish Fits Listed Models Using Delco Switch Case Replaces: #A20346	

B5003-008	Ignition Key Switch	\$24.99
	Includes 2 Keys, 2 Spade Terminals Designed for 0.800" hole diameter. Case Fits: VA, VAC, VAI, VC, and various other Case models with 2 wire switch	

B5003-024	Ignition Key Switch w/ 2 Keys & Mounting Nut	\$19.99
	12-volt, 35-amp, 7 spade terminals, fits 1" hole. 4 Positions: Accessory, Off, Run, & Start Case Replaces: #282775A1, A77312, B91586, D134737, D88103, L36185, L55655, L61053, L76350, L77451, L77723, L77873, R57312, R6961 Fits: 2470 (SN: 8,825,001 & up), 2670 (SN: 8825001 & up), along with various Case IH models	

Momentary Switches

B5004-003	Momentary Push Switch	\$15.75
	Manual Push Button Solenoid Switch with Rubber Protected Cap (2 Screw Terminals) Mounting Stem 5/8"-32 Thread Case Replaces: #86900358, A30858, 09995AB Fits (Starter Switch): Super 400, 400, 401, 402, 403, 405, 410, 411, 412, 413, 414, 420, 425, 500, 520, 600, 610, 620, Industrial: 750, W14, W14H, W18, W20, W24, W24B, W26, W4	

B5004-004	Manual Push Button Starting Switch	\$14.99
	Wires Attach To Switch With Eyelets & Screws. (O.E.M.) Case Replaces: #A36948 Fits: 580B, 586CKB, 330, 430, 470, 480, 530, 570, 580, 584, 585, 586, 770, 870, 970, 1030, 1070, 1090, 1170, 1175, 1270, 1370, 1570, 2470, 2670, 2870, 4490, 4690, 4890	

STARTER SWITCHES (MECHANICAL) & SOLENOIDS

B5004-009	Neutral Safety Switch Boot	\$11.99
	<p>Fits 1.000" Dia. Switch, 1.125" Deep, 0.140" Wire hole diameter.</p> <p>Case Replaces: #A20991</p> <p>Fits: 30, 430CK,431, 435, 441, 445, 470, 480CK,480 Loader, 530, 530CK, 531, 535, 540, 541, 545, 570, 580CK, 580 Loader, 630, 631, 632, 634, 640, 641, 642, 644, 730, 730 Comfort King, 730 Draft-O-Matic, 730CK, 731,732, 733, 734, 740, 741 742, 743, 744, 830, 830 Comfort King, 830 Draft-O-Matic, 831, 832, 833, 840, 841, 842, 843, 930, 930 Comfort King, 930 Draft-O-Matic, 931, 932, 940, 941, 1030, 1030 Comfort King, 1030 Draft-O-Matic, 1031, 1032, 1270, 1370, 2470, W3</p>	

B5010-005	4-Position Rotary Light Switch	\$49.99
	<p>12-Volt, <i>OEM Serviceable, Knob Looks Different & Must Wire According To Rear Of Switch</i></p> <p>Case</p> <p>Replaces (<i>Serviceable</i>): #A20620</p> <p>Fits: [1030 Comfort King, 1030 Draft-O-Matic, 700B, 701B, 702B, 703B, 705B, 710B, 711B, 712B, 713B, 715B, 725B, 730 Comfort King, 730 Draft-O-Matic, 730CK, 800B, 801B, 802B, 803B, 805B, 810B, 811B, 812B, 813B, 815B, 830 Comfort King, 830 Draft-O-Matic, 900B, 910B, 920B, 930 Comfort King, 930 Draft-O-Matic, 700, 701, 702, 703, 705, 710, 711, 712, 713, 715, 730, 731, 732, 733, 734, 740, 741, 742, 743, 744, 800, 801, 802, 803, 810, 811, 812, 813, 815, 830, 831, 832, 833, 840, 841, 842, 843, 900, 910, 920, 930, 931, 932, 940, 941, 1030, 1031, 1032</p>	

Pressure Switches

B5012-001	Oil/Fuel Electric Pressure Sensor Switch	\$15.99
	<p>Designed to be screwed into the engine block. Lead runs to a dummy light.</p> <p>Case</p> <p>Replaces: #A13794</p> <p>Fits: [W10, W14, W5, W5A, W7, W9A, 1030, 1030 Comfort King, 1030 Draft-O-Matic, 1031, 1032, 470, 480, 480B, 480CK, 570, 580, 580B, 580B Construction King, 580CK, 580 Construction King, 680, 680B, 680C, 780, 930, 930 Comfort King, 930 Draft-O-Matic, 931, 932, 940, 941 (used as an oil or fuel pressure switch)], [430, 430CK, 431, 435, 440, 441, 445, 530, 530CK, 530 Construction King, 531, 535, 540, 541, 545 (used as an oil or fuel pressure switch on SN: 8262800 & up)], [730, 730CK, 730 Comfort King, 730 Draft-O-Matic, 731, 732, 733, 734, 740, 741, 742, 743, 744, 830, 830 Comfort King, 830 Draft-O-Matic, 831, 832, 833, 840, 841, 842, 843 (used as an oil or fuel pressure switch on SN: 8253501 & up)]</p>	

B5006-001	Starter Switch (Long Shaft)	\$12.75
	<p>6 or 12 Volt Panel Mounted Manual Push Start Switch</p> <p>Replaces: Case - #04981-AB, VT3588, Delco - #192119, D900, 450C Prestolite - #15-121, 15-122, 15-409, 15-45, 15-47, 15-50, 15-51, SW-2916, SW-4001, SW-4002, SW-4005, SW-4010, SW-4013, SW-4015, SW-4017, SW-4101, SWX-47</p> <p>Fits: Case - D, LA, S, VA, VC, VI, VO</p>	

B5007-002	12 Volt Solenoid	\$17.50
	<p>12 Volt, 3 Terminal Solenoid With A Curved Mounting Bracket</p> <p>Fits: Case - (210B, 211B With Prestolite), 300, 300B, 310, 320430, 435, (440, 441, 450, 470, 480, 540, 540C, 541, 541C, With Prestolite), 600 Diesel, 630 Gas, 640, 640C, 641, 641C</p>	

B5007-010	12 Volt Solenoid (Manual Push Button)	\$20.00
	<p>12 Volt, 3 Terminal Solenoid With A Curved Mounting Bracket & Manual Push Button.</p> <p>Replaces:</p> <p>Autolite - SAE-4005, 15-60, SAW-4201</p> <p>Fits: Case - (210B, 211B With Prestolite), 300, 300B, 310, 320430, 435, (440, 441, 450, 470, 480, 540, 540C, 541, 541C, With Prestolite), 600 Diesel, 630 Gas, 640, 640C, 641, 641C</p>	

B5007-004	12 Volt Solenoid	\$23.75
	<p>Has a Curved Bracket & 4 Terminals (Used with 30 & 35 MT Delco Starters)</p> <p>Fits: Case: [730, 770, 830, 870, 930, 970, 1090, 1170, 1175, 1270 (Diesel)], 1070 (Diesel use with starter 1113478, 1113399), [1370, 1470, 1570, 2470 (Diesel use with starter 1113399)]</p> <p>Replaces: Delco: #1119890, 1119912, 1119885, 1119877, 1119935, 1119882, 1119906, D953, D985, 1119833, 1119883, 1115537, 1119978, 1115582, 1119778, 1115508, 1115529, 1115540, 1115501</p> <p>Case - #A44894, A42326, A40461, A43846</p>	

B5007-017	12 Volt Lucas Solenoid	\$29.75
	<p>12 Volt Rated Solenoid with 4 Terminals for Lucas M45G, M127, M418G Starters. 2 Hole Mount Stud & Removable Plunger.</p> <p>Replaces:</p> <p>Lucas - 76755, 76763, 76786, 76796, 76800, 76803, 76804, 76815, 76816, 76820, 76821, 76823, 76824, 76826, 76827, 76837, 76850, 76852, 76855, 76871, 76885, 76891, 76892, 76894, 76895, 76896, 76897, 76899, 76902, 76908, 76940, 76961, 76982, 76983, 77034, 77035, 77058, 77157, 77160, TOB109, TOB113, TOB121, TOB128, TOB134, TOB162, TPB107</p> <p>Case - K963825 Fits: Case - Various Models</p>	

B5007-018	Lucas M50 12 Volt Starter Solenoid	\$40.75
 <p>12 Volt Rated Solenoid for Lucas M50 Direct Drive Starters. Has 4 Terminals. Replaces: Lucas - #27228A, 76740, 76753, 76756, 76781, 76825, 76833, 76834, 76835, 76836, 76854, 76862, 76864, 76865, 76869, 76881, 76900, 76905, 76910, 76911, 76912, 76913, 76928, 76956, 77010, 77014, 77025, 77032, 77052, 77109, TOB108, TOB110, TOB111, TOB114, TOB129, TOB133, TOB179, TOB184, TOB199 Case - #320518R2, K964215 Fits: Case - 1394, 1410, 1494, 1594, 1690</p>		

B5007-024	Delco 12 Volt Solenoid	\$109.50
 <p>12 Volt Rated Solenoid for Delco 40MT & 50MT Direct Drive Starters with 4 Terminals. Replaces: Delco - #1119835, 1119853, 1119862, 1119879, 1119895 Case - #A47931 Fits: Case - 2090, 2290, 2470, 2590, 4490, 4690, 4890, 4894, 4994</p>		

6-Volt Delco Type Voltage Regulator		
B8002-013	Premium Quality, USA Made	\$119.75
B8002-014	Standard Quality	\$34.75
 <p>6 Volt, Positive Ground, 4 Terminals, Flat Mounting Bracket Replaces: Delco - #1116807, 1116816, 1118291, 1118308, 1118780, 1118982, 1119575, D645, D657 Prestolite - #8-291, GRX-291 Fits: Case - 200B with Delco Generator</p>		

Delco Type Voltage Regulator		
B8002-019	Premium Quality, Made in the USA	\$116.51
B8002-020	Standard Quality	\$34.75
 <p>12 Volt, <i>Generator Mounted</i> Delco Voltage Regulator Replaces: Case - #A22684, A33983 Delco - #1118792, 1118991, D649 Prestolite - #8-295, GRX-408 Fits: Case - 301, 680CK, 700B, 730, 734, 740, 1030, 1070, 1090, 1170</p>		

Cutout Relays & Voltage Regulators

Note: Due to modern battery design, voltage regulators can't be used to charge low or dead batteries. Doing so will destroy the voltage regulator and void the warranty.

B8001-001	6-Volt Cutout Relay	\$19.50
 <p>15 Amps, 6 Volt Works Positive or Negative Ground Replaces: Autolite -CB4014, C4012(9-5), C4012(9-4), C4012(9-1), R40061 Delco - #266P, 266N, 265P, 265N, 5015850, 812970, 265J, 820845, 812971, 1116816, 265G, 265H, 1116755, 1116751, 1116809DR, 265B, 1842859, 265C, 1867781, 265F, 265D Fits: Case - D, DC, DC-3, DC-4, DCS, DEX, DH, DI, DO, DV, LA, LAH, LAI, R, RC, S, SC, SC-3, SC-4, SI, SO, V, VA, VAC, VAC-11, VAC-12, VAC-13, VAC-14, VAE, VAH, VAI, VAIW, VAIW-3, VAO, VAS VC, VI, VO With Generator #GBM-4823A-5 VC, VI, VO with Generator #GAS-4169A</p>		

B8001-002	Electronic Cutout Relay	\$19.50
 <p>25 Amp, Works with 6, 12, or 24 Volts. & Positive or Negative Ground Replaces: Autolite - #CB4014, C4012 (9-5), C4012 (9-4), C4012 (9-1), R40061 Delco - #266P, 266N, 265P, 265N, 5015850, 812970, 265J, 820845, 812971, 1116816, 265G, 265H, 1116755, 1116751, 1116809DR, 265B, 1842859, 265C, 1867781, 265F, 265D Fits: Case - D, DC, DC-3, DC-4, DCS, DEX, DH, DI, DO, DV, LA, LAH, LAI, R, RC, S, SC, SC-3, SC-4, SI, SO, V, VA, VAC, VAC-11, VAC-12, VAC-13, VAC-14, VAE, VAH, VAI, VAIW, VAIW-3, VAO, VAS, VC, VI, VO (with Generator #GBM-4823A-5VC), VI, VO (with Generator #GAS-4169A)</p>		

BRUSH SETS

X349	Brush Set	\$7.75
		Case Fits: 200B with Delco Generator

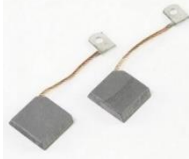
X270	Brush Set	\$5.00
		Case Fits: 301, 680CK, 700B, 730, 734, 740, 1030, 1070, 1090, 1170 with 12 Volt, Generator Mounted Delco

IDENTIFICATION TAGS

B9013-001	Small Autolite I.D. Tag (Blank)	\$7.00
	Small Autolite I.D. Tag (Stamped)	\$14.25
		2 5/16" Long, Black I.D. Tag for Distributors, Starters, & Generators with Rivets

B9013-002	Large Autolite I.D. Tag (Blank)	\$7.00
	Large Autolite I.D. Tag (Stamped)	\$14.25
		2 15/16" Long, Black I.D. Tag for Distributors, Starters, & Generators with Rivets

Delco Remy

B9013-004	Delco Remy I.D. Tag (Blank)	\$7.00
	Delco Remy I.D. Tag (Stamped)	\$14.25
		Black Delco-Remy I.D. Tag for Distributors, 6 Volt Starters, & 6 Volt Generators with Rivets, 3/4" 2 5/16"
B9013-005	Red Delco Remy I.D. Tag (Blank)	\$7.00
	Red Delco Remy I.D. Tag (Stamped)	\$14.25
		Red Delco-Remy I.D. Tag for 12 Volt Starters & 12 Volt Generators with Rivets, 3/4" 2 5/16"
B9013-006	Orange Delco Remy I.D. Tag (Blank)	\$7.00
	Orange Delco Remy I.D. Tag (Stamped)	\$14.25
		Orange Delco-Remy I.D. Tag for 24 Volt Starters, & 24 Volt Generators with Rivets, 3/4" 2 5/16"
B9013-013	Delco Remy I.D. Tag (Blank)	\$7.00
	Delco Remy I.D. Tag (Stamped)	\$14.25
		Black Delco-Remy I.D. Tag for Distributors, 6 Volt Starters, & 6 Volt Generators with Rivets, 3/4" 2 5/16"

ALTERNATORS

B6001-001	12 Volt Alternator (1 Wire)	\$112.75	
63 Amp, Low Cut In, Specially Built For Tractors, Forklifts, & Other Low Engine Speed Applications			
B6001-002	12 Volt Alternator (1 or/3 Wire)	\$118.75	
63 Amp, With 1 Wire Or 3 Wire For Warning Lamp On Automobiles & Trucks			
B6001-006	6-Volt Alternator	\$166.50	
40 Amp, Negative Ground, 1-Wire			
B6001-011	12-Volt Alternator with Mechanical Tachometer Drive	\$129.75	
63 Amp, Negative Ground, 1 Wire, Internally Regulated, 1/2" Groove Pulley			

Small ND Type

B6002-003	12 Volt Small Denso Alternator (1 Wire)	\$119.75
		40 Amp, 1 Wire Internal Regulator. Will Start Charging with a Much Lower Engine Speed. Comes with a 4 1/2" Housing Diameter, 3/8 To 1/2" Belt width & a 2 1/2" Pulley Diameter. Excellent for Converting a 6 Volt System to 12 Volt. Negative Ground Only & is Self-Excited

LIGHTS & LIGHT PARTS

B9016-003	Flat Lens Type Head Lamp	\$99.99
		6 Volt Head, & clear rear lamp (can be used as 12 volt by Changing bulb) Case Fits: C, CC, CC-3, CC-4, CCS, CI, LA, LAI, RC, V, VC, VI Replaces: #O6752AB, VT2615, O4576AB

PARTS FOR LIGHT ABOVE

Headlamp & Parts are interchangeable with original except as noted

B9017-002	7" Lens With Guide Name	\$21.99
B9017-003	7" Clamp Ring	\$17.99
B9017-005	7" Gasket	\$8.99
B9017-006	7" Reflector *Call for Availability*	\$16.50
B9017-067	7" Light Terminal	\$6.00
B9017-013	6 Volt Bulb <i>Fits Above Reflector, Not Original</i>	\$3.00
	Pack of 10	\$25.50
B9017-015	12 Volt Bulb <i>Fits Above Reflector, Not Original</i>	\$3.00
	Pack of 10	\$25.50

B9016-006	Bullet Type Head Lamp	\$57.99
		6 Volt Head, & Clear Rear Lamp (usable as 12 volt by changing bulb) Case Replaces: #VT3660 Fits: VA, VAC, VAH Up To Serial #5,400,000)

PARTS FOR LIGHT ABOVE

B9017-056	4 3/4" Lens with Guide Name	\$14.99
B9017-057	4 3/4" Clamp Ring (Black)	\$15.99
B9017-058	4 3/4" Gasket	\$3.99
B9017-004	4 3/4" Reflector	\$14.99
B9017-067	4 3/4" Light Terminal	\$6.00
B9017-013	6 Volt Bulb	\$3.00
	Pack of 10	\$25.50
B9017-015	12 Volt Bulb	\$3.00
	Pack of 10	\$25.50

Headlight Assembly		
B9016-016	Bullet Type 6 Volt Head	\$54.99
B9016-082	Bullet Type 12 Volt Head	\$54.99
	Case Replaces: # VTA3026, VTA3027, VT3665 Fits: VA, VAC, VAC-12, VAC-13, VAC-14, VAH, VAI, VAIW, VAIW-3, VAO, VAO-15, VAS (Serial #541,000 & Up)	

PARTS FOR LIGHT ABOVE		
B9017-056	4 3/4" Lens with Guide Name	\$14.99
B9017-057	4 3/4" Clamp Ring (Black)	\$15.99
B9017-058	4 3/4" Gasket	\$3.99
B9017-004	4 3/4" Reflector	\$14.99
B9017-067	4 3/4" Light Terminal	\$6.00
B9017-013	6 Volt Bulb	\$3.00
	Pack of 10	\$25.50
B9017-015	12 Volt Bulb	\$3.00
	Pack of 10	\$25.50

B9016-075	12 Volt Sealed Beam Combo Tail Light Assembly	\$116.95
	4 3/4" diameter Case Replaces: A20965 Fits: 300B, 430, 530, 630, 730, 930, 1030, 310B, 311B, 400B, 411B, 470, 500B, 511B, 570, 600B, 611B, 830, 1030 Comfort King, 1031, 1032, 580B, 312B, 410B, 843, 830 Comfort King, 730 Draft-O-Matic, 940, 832, 743, 730 Comfort King, 734, 831, 580B Const King, 731, 1030 Draft-O-Matic, 302B, 931, 732, 941, 301B, 730CK, 830 Draft-O-Matic, 932, 733, 431, 435, 441, 445, 480, 510B, 531, 535, 540, 541, 545, 610B, 614B, 631, 632, 634, 640, 641, 642, 644, 740, 741, 742, 744, 840, 841	

PARTS FOR LIGHT ABOVE		
B9017-069	Sealed Beam, 12 Volt Bulb	\$19.99
	Combination Rear Lamp w/ transparent red background using separate bulb Replaces: 4409, A40855	

B9017-115	LED Combination Rear Light Bulb, Red/White, Sealed Beam	\$49.99
	Flood Pattern, 18 Watts, 1200 Lumens, Can Be Switched to White or Red Light Case Replaces: 4409, A40855 Fits 4 1/2" O.D. Housing with Either Metal or Rubber Bezel	

Sealed Beam Head Lamp Assembly for Flat Top Fenders		
B9016-022	12 Volt Low Beam	\$39.99
B9016-023	12 Volt High Beam	\$59.75
B9016-080	12 Volt LED Trapezoid	\$67.99
B9016-081	12 Volt LED Flood Light	\$67.99
	Case Replaces: #A64498, A32536, A59701 Fits: 480B, 480C, 580B, 770, 870, 970, 930 Comfort King, 1030 Comfort King, 1070, 1170, 1175, 1270, 1370, 2470, 2670	

PARTS FOR LIGHT ABOVE		
B9017-031	Sealed Beam, 12 Volt High Beam	\$18.99
B9017-032	Sealed Beam, 12 Volt Low Beam	\$16.50
	4 1/2" diameter Case - 584, 585, 586C, 680B, 680C, 730, 770, 830, 930, 1030 Industrials: 310F, 310G, 350B, 450, 480, 480B, 480C, 480D, 480LL, 580, 580C, 750, & 1000D	

	B9017-009	\$5.99
Concave Light Mounting Washer/Retainer		

B9017-097	12-Volt LED Lamp, Trapezoid Beam Pattern	\$49.99
	Case Replaces: #4411, A24572, A40855, A42295, D71409, E98744 Fits: 430, 431, 435, 441, 445, 450C Industrial, 455C Industrial, 470, 480, 530, 531, 535, 540, 541, 545, 570, 580B Industrial, 680C Construction King Industrial, 730, 730 CK, 730 Draft-O-Matic, 731, 732, 733, 734, 740, 741, 742, 743, 744, 770, 830, 830 CK, 830 Draft-O-Matic, 831, 832, 833, 840, 841, 842, 843, 870, 930, 930 CK, 930 Draft-O-Matic, 931, 970, 1000 Industrial, 1030, 1030 CK, 1030 Construction King, 1030 Draft-O-Matic, 1031, 1032, 1070, 1090, 1170, 1530 Skid Steer, 1537 Skid Steer	

B9017-098	12-Volt LED Lamp, Flood Beam Pattern	\$49.99
	Case Replaces: #A43639, A47179, D33182, L30464 GE: #4410, 4411 Fits: 350, 580B, 580B Construction King, 585, 680C Construction King, 730, 731, 732, 733, 734, 740, 741, 742, 743, 744, 770, 830, 830 Comfort King, 830 Draft-O-Matic, 831, 832, 833, 840, 841, 842, 843, 870, 930, 930 Comfort King, 930 Draft-O-Matic, 931, 940, 941, 970, 1000, 1030, 1030 Comfort King, 1030 Draft-O-Matic, 1090, 1170, 1175, 1200, 1200TK, 1270, 1370, 1470, 1470TK, 1570, 1830, 2090, 2290, 2390, 2470, 2590, 2670, 2870, 4490, 4690, 4890 Industrials: 310F, 310G, 350B, 450, 450B, 480 Loader, 480B, 480C, 480CK, 480D, 480LL, 580 Construction King, 580 Loader, 580C, 580CK, 584, 584C, 584D, 585C, 585D, 586C, 586D, 680, 680B, 680C, 680CK 750, 1835, 1845, 1845S	

Bullet Type Work/ Tail Light with Switch		
B9016-021	6 Volt Red (B9016-083 for Black*)	\$79.99
B9016-018	12 Volt Red (B9016-084 for Black*)	\$79.99
	Combo/Red Dot Tail Lamp Case Replaces: 12 VOLT: #A11898 Fits: 300B (Early), VA, VAC, VAC-11, VAC-12, VAC-13, VAC-14, VAH, VAI, VAIW, VAIW-3, VAO, VAO-15, VAS (*Black versions sold for lower prices)	

PARTS FOR LIGHT ABOVE		
B9017-056	4 3/4" Lens with Guide Name	\$14.99
B9017-059	4 3/4" Clamp Ring (Red)	\$15.99
B9017-058	4 3/4" Gasket	\$3.99
B9017-007	4 3/4" Reflector	\$21.99
B9017-067	4 3/4" Light Terminal	\$6.00
B9017-010	Light Switch Assembly	\$18.50
B9017-013	6 Volt Bulb	\$3.00
	Pack of 10	\$25.50
B9017-015	12 Volt Bulb	\$3.00
	Pack of 10	\$25.50
B9017-037	6 Volt Miniature Bulb	\$1.25
B9017-039	12 Volt Miniature Bulb	\$1.25
B9017-066	Red Dot Jewel Lens Assembly	\$17.99
B9017-077	Rear Combo Light Switch with Knob (3 Screw Terminals)	\$18.50

B9016-054	Round Fender & Cab Mount Warning Light	\$19.99
	Restoration Quality 12 Volt Round Light with 2 x 4" Diameter Amber Lenses, Double Contact Bulb, 1/2" Diameter Stud, & 2.4" Thick at Widest Point. Case Replaces: #A143600, A34853, D49734 Fits: 1030, 1070, 1170, 1175, 1270, 1370, 430, 470, 480, 480B, 480C, 480D, 480LL, 530, 570, 580, 580B, 580C, 580D, 584, 584C, 584D, 585, 585C, 585D, 586, 586C, 586D, 680, 730, 770, 830, 870, 930, 970	

B9016-055	Rectangular Fender & Cab Mount Warning Light	\$32.99
	Restoration Quality 12 Volt Rectangular Light. One Red and One Amber Lens With Amber Side Marker, 4.5" Wide & 1/2" Diameter Stud Case Replaces: #A44201 Fits (serviceable for models with rectangular warning lights): 1070, 1175, 1190, 1270, 1370, 1570, 2090, 2290, 2390, 2470, 2590, 2670, 2870, 4490, 4690, 4890, 770, 870, 970	

Bullet Type Galvanized Steel 5 3/4" Headlight/ Work Lamp		
B9016-045	6 Volt Headlight	\$85.99
B9016-046	12 Volt Headlight	\$85.99
	Case Replaces: O6330AB, O9668AB Fits: DC, LA, LAH, LAI, SC (When converted to 12 volt), 400, 401, 402, 403, 405, 410, 411, 412, 413, 414, 415, 420, 425, 500, 520, 600	

PARTS FOR LIGHT ABOVE		
B9017-071	5 3/4" Lens with Guide Name	\$34.99
B9017-072	5 3/4" Clamp Ring	\$27.99
B9017-073	5 3/4" Gasket	\$4.99
B9017-075	5 3/4" Reflector	\$29.99
B9017-013	6 Volt Bulb	\$3.00
	Pack of 10	\$25.50
B9017-015	12 Volt Bulb	\$3.00
	Pack of 10	\$25.50

DASH LAMPS

B9016-013	Chrome Finish Dash Lamp	\$19.75
B9016-014	Black Finish Dash Lamp	\$19.75
	6 or 12 Volt. Bulb not included. 6 Volt Use Bulb #B9017-046, 12 Volt Use Bulb #B9017-049 Fits: Case - Various Models	

Light Bulbs

B9017-046	6 Volt Bulb	\$1.25
B9017-049	12 Volt Bulb	\$1.25
	Light bulbs for products #B9016-013, B9016-014	

B9017-036	6-Volt Sealed Beam Bulb	\$14.50
	30-Watt, Double Contact, 4.5" Diameter, Low Beam Case Replaces: GE #4511 Fits: 770 & other later models with flat top fenders	

INDIVIDUAL LIGHT PARTS



B9017-088	Lamp Socket, Tellight	\$14.75
	Used as a wiring lead in various tractors and industrial applications. Case	

B9017-128	Indicator Lamp Spring	\$2.50
	Case Fits: 430, 470, 480 Loader, 480B, 530, 570, 580 Loader, 580B, 580B, 584, 586, 1030 Comfort King, 1835	

B9017-129	Indicator Lamp Bulb	\$1.99
	Case Replaces: #1895R Fits: 430, 470, 480 Loader, 480B, 530, 570, 580 Loader, 580B, 580B, 586, 584, 1030 Comfort King, 1835	

B9017-132	Right or Left Indicator Lens	\$14.99
	Case Replaces: #A77188 Fits: 870 (SN: 8,675,001 and up), 970 (SN: 8,675,001 and up), 1070 (SN: 8,675,001 and up), 1175, 1270 (SN: 8,736,001 and up), 1370 (SN: 8,727,601 and up), 2470 (SN: 8,762,940 and up), 2670	

AUXILIARY PLUGS & SOCKETS





B9032-001	2 Pole Auxiliary Plug	\$23.75
	Fits: Case -200, 300, 350, 400	
B9032-002	2 Pole Auxiliary Connector	\$19.75
	(Used With B9032-001) Fits: Case -200, 300, 350, 400	

CIGARETTE LIGHTERS

B9030-001	6 Volt Cigarette Lighter	\$29.99
	Anodized Aluminum Knob is Engraved with the word Lighter Case Replaces: G46107, G13282, G13281 Fits (with 6 Volt systems): 200B, 210B, 211B, 200, 210, 211, 300	
B9030-002	12 Volt Cigarette Lighter	\$29.99
	Anodized Aluminum Knob is Engraved with the word Lighter Case Replaces: #A24134, G13345, A24082, G13344 Fits (serviceable): 1030 Comfort King, 1030 Draft-O-Matic, 300B, 301B, 302B, 310B, 311B, 312B, 320B, 400B, 410B, 411B, 420B, 420BD, 430CK, 500B, 510B, 511B, 530 Construction King, 530CK, 600B, 610B, 611B, 614B, 701B, 702B, 703B, 705B, 710B, 711B, 712B, 713B, 715B, 725B, 730 Draft-O-Matic, 730CK, 800B, 801B, 802B, 803B, 805B, 810B, 811B, 812B, 813B, 815B, 830 Comfort King, 830 Draft-O-Matic, 900B, 910B, 920B, 930 Comfort King, 930 Draft-O-Matic, W10, W10B, W10C, W10E, W12, W3, W5A, W7, W7C, W7E, W8B, W8C, W8E, W9B, W9C, W9E, 300, 301, 302, 310, 311, 312, 320, 430, 431, 435, 440, 441, 445, 470, 530, 531, 535, 540, 541, 545, 570, 630, 631, 632, 634, 640, 641, 642, 644, 700, 701, 702, 703, 705, 710, 711, 712, 713, 715, 730, 731, 732, 733, 734, 740, 741, 742, 743, 744, 800, 801, 802, 803, 810, 811, 812, 813, 815, 830, 831, 832, 833, 840, 841, 842, 843, 900, 930, 931, 932, 940, 941, 1030, 1031, 1032, 1200	
B9030-003	12 Volt Cigarette Lighter	\$27.99
	The knob is black plastic with the word 'lighter' in white printing. Case Replaces: #F63530, F63531 Fits (SN: 8675001 & up): 870, 970, 1070 (all): 1175, 1270, 1370, 2470, 2670	

CARBURETOR REBUILD KITS

B9022-003	Marvel-Schebler Carburetor Rebuild Kit	\$24.99
	Case Tractors Model D, 400, 410, 700, 710, 725, 810, 840 Fits Carburetor: Marvel-Schebler #TSX11, TSX616, TSX780, TSX782, TSXU838, TSXU839 Case #01820AB, A-7777, A-20624, A-20685	

B9022-008	Zenith Carburetor Rebuild Kit	\$26.95
	Case Tractors Model R, RC, RI, S, SC, SI, SO, VA, VAC, VAI, VAS Fits Carburetor: Zenith #9667, 9667A, 10136, 11106, 11106A, 11506, 12522, 12544 Case # 030983-HT, 05771-AB, VTA-894, VTA-4703	
B9022-009	Zenith Carburetor Rebuild Kit	\$27.99
	Case Tractors Model CC, C, DC, DT, DIM, DO, DST, D2, 400, 510, 510B, 511B, 600 Fits Carburetor: Zenith #8964, 8964B, 11622, 11644, 12255, 12255A, 12255C, 12329, 12329A, 14644 Case #04990, 45719, G-45162	
B9022-011	Zenith Carburetor Rebuild Kit	\$24.99
	Case Tractors Model S, SC, SI, SO, G159, G188, 300, 400, 500, 580CK, 600, 770, 251 Engine Fits Carburetor: Zenith #11535, 12509, 12534, 12992, 12994, 13106, 13328, 13374 Case #09658-AB, A-37173, A-38249, G-45748, G-45772, XA-91989	
B9022-023	Marvel-Schebler Carburetor Rebuild Kit	\$24.50
	Case Tractor Model EXA-124, 200, 200B, 210, 210B, 211, 211B, 300, 300B, 310, 310B, 310C, 310D, 310F, 310G, 311, 311B, 312, 312B, 320, 320B, 350, 351, 430, 430CK, 440, 441, 445, 470, 480, 480B, 480CK, 600, V, VA, VAB, VAC, VAC-11, VAC-12, VAC-13, VAC-14, VAE, VAH, VAI, VAIW, VAIW-3, VAO, VAO-15, VAS, VC, VI, VT3200, 148VA, VO Fits Carburetor: Marvel-Schebler #1004SL, TSX101, TSX102, TSX103, TSX112, TSX113, TSX114, TSX119, TSX120, TSX126, TSX128, TSX13, TSX132, TSX132A, TSX133, TSX134, TSX136, TSX137, TSX138, TSX140, TSX141, TSX142, TSX144, TSX146, TSX147, TSX148, TSX150, TSX151, TSX154, TSX155, TSX156, TSX157, TSX159, TSX161, TSX167, TSX171, TSX173, TSX179, TSX180, TSX182, TSX183, TSX184, TSX186, TSX188, TSX189, TSX190, TSX191, TSX192, TSX193, TSX194, TSX197, TSX198, TSX202, TSX203, TSX206, TSX206-1, TSX211, TSX212, TSX225, TSX228, TSX231, TSX237, TSX239, TSX239-1, TSX240, TSX241A, TSX241B, TSX241C, TSX246, TSX248, TSX253, TSX254, TSX258, TSX260, TSX264, TSX266, TSX267, TSX269, TSX272, TSX274, TSX278, TSX28, TSX280, TSX286, TSX287, TSX288, TSX289, TSX29, TSX290, TSX297, TSX30, TSX301, TSX305, TSX306, TSX308, TSX309, TSX312, TSX314, TSX315, TSX319, TSX322, TSX323, TSX326, TSX328, TSX33, TSX330, TSX331, TSX332, TSX333, TSX334, TSX335, TSX338, TSX339, TSX34, TSX341, TSX346, TSX347, TSX348, TSX35, TSX351, TSX352, TSX356, TSX357, TSX358, TSX359, TSX36, TSX361, TSX361-A, TSX363, TSX366, TSX367, TSX368, TSX37, TSX370, TSX370-1, TSX377, TSX38, TSX380, TSX388, TSX389, TSX39, TSX391, TSX398, TSX400, TSX403, TSX405, TSX406, TSX407, TSX409, TSX418, TSX419, TSX42, TSX420, TSX421, TSX422, TSX423, TSX428, TSX43, TSX44, TSX443, TSX447, TSX448, TSX45, TSX450, TSX452, TSX453, TSX455, TSX458, TSX459, TSX465, TSX470, TSX472, TSX474, TSX48, TSX480, TSX481, TSX484, TSX486, TSX49, TSX497, TSX500, TSX507, TSX510, TSX513, TSX514, TSX516, TSX518, TSX520, TSX525, TSX531, TSX532, TSX534, TSX539, TSX54, TSX541, TSX55, TSX551, TSX552, TSX556, TSX558, TSX560, TSX567, TSX569, TSX570, TSX573, TSX577, TSX58...	

CARBURETOR FLOATS

<p>...TSX580, TSX589, TSX59, TSX593, TSX595, TSX597, TSX60, TSX603, TSX605, TSX606, TSX611, TSX614, TSX618, TSX626, TSX633, TSX635, TSX643, TSX646, TSX649, TSX649-1, TSX650, TSX653, TSX655, TSX656, TSX660, TSX663, TSX665, TSX668, TSX670, TSX671, TSX676, TSX680, TSX681, TSX683, TSX69, TSX690, TSX691, TSX692, TSX694, TSX696, TSX701, TSX706, TSX709, TSX710, TSX714, TSX730, TSX736, TSX74, TSX742, TSX744, TSX748, TSX753, TSX76, TSX762, TSX765, TSX767, TSX770, TSX771, TSX776, TSX776-1, TSX78, TSX781, TSX787, TSX79, TSX793, TSX796, TSX80, TSX802, TSX803, TSX804, TSX809, TSX812, TSX815, TSX820, TSX826, TSX827, TSX83, TSX830, TSX841, TSX844, TSX85, TSX851, TSX855, TSX857, TSX860, TSX862, TSX864, TSX865, TSX866, TSX879, TSX88, TSX882, TSX89, TSX896, TSX896SL, TSX90, TSX901, TSX91, TSX912, TSX913, TSX914, TSX919, TSX926, TSX930, TSX931, TSX936, TSX936SL, TSX937, TSX937SL, TSX94, TSX948, TSX949, TSX95, TSX954, TSX957, TSX957SL, TSX95A, TSX96, TSX971, TSX976, TSX978, TSX979, TSX979-1, TSX98, TSX983, TSX986, TSX987, TSX99, TSX990, TSX991, TSX991-1, TSX996, TSXU828, TSXU829, TSXU830, TSXU831, TSXU832, TSXU833, TSXU834, 1003 Case: #A38240, A38241, A38242, A38243, A38971, G11050, G11057, G11140, G11160, G45160, G45779, VT2072, VT2475, VT2632, VT3593, VT4062, VT4121, VT4275, VTA2933, VTA4714, VTA976</p>

B9022-005	Marvel-Schebler Carburetor Rebuild Kit	\$23.99
------------------	---	----------------

	<p>Case Tractors Model 530, 540, 541, 545, 600B, 610B, 611B, 614B, 640, 641, 642, 644 Replaces: Case - #G45773, G45774, G46784 Fits Carburetor: Marvel-Schebler #TSX1001, TSX1002, TSX181, TSX221, TSX245, TSX296, TSX332, TSX332, TSX360, TSX374, TSX397, TSX413, TSX414, TSX436, TSX464, TSX466, TSX475, TSX492, TSX505, TSX506, TSX506A, TSX526, TSX528, TSX530, TSX561, TSX562, TSX563, TSX575, TSX582, TSX592, TSX596, TSX602, TSX605, TSX606, TSX610, TSX615, TSX633, TSX639, TSX641, TSX645, TSX648, TSX662, TSX678, TSX688, TSX689, TSX695, TSX704, TSX711, TSX713, TSX719, TSX721, TSX725, TSX732, TSX737, TSX738, TSX755, TSX756, TSX757, TSX759, TSX768, TSX769, TSX772, TSX773, TSX775, TSX777, TSX784, TSX788, TSX791, TSX792, TSX797, TSX798, TSX799, TSX800, TSX801, TSX806, TSX808, TSX810, TSX811, TSX813, TSX814, TSX816, TSX819, TSX825, TSX836, TSX843, TSX849, TSX853, TSX854, TSX856, TSX857, TSX867, TSX869, TSX871, TSX877, TSX878, TSX881, TSX883, TSX884, TSX885, TSX886, TSX888, TSX889, TSX892, TSX892S, TSX893, TSX894, TSX895, TSX897, TSX898, TSX899, TSX900, TSX902, TSX903, TSX904, TSX904SL, TSX905, TSX905-1, TSX905SL, TSX906, TSX906SL, TSX907, TSX907SL, TSX908, TSX908SL, TSX911, TSX917, TSX920, TSX920SL, TSX921SL, TSX922, TSX922SL, TSX923, TSX923SL, TSX925, TSX927, TSX928, TSX932, TSX932SL, TSX934, TSX934SL, TSX938, TSX938SL, TSX939, TSX940, TSX940SL, TSX941, TSX941SL, TSX942, TSX943, TSX944SL, TSX945SL, TSX946, TSX947SL, TSX949, TSX950, TSX952, TSX952SL, TSX955, TSX959, TSX959SL, TSX961, TSX961SL, TSX962, TSX962SL, TSX964SL, TSX965SL, TSX966, TSX967SL, TSX968SL, TSX97, TSX972, TSX973, TSX974, TSX974SL, TSX975, TSX975SL, TSX977, TSX980, TSX980SL, TSX984SL, TSX985, TSX985SL, TSX988, TSX989, TSX993, TSX994, TSX997, TSX998, TSX999, TSXU1006, TSXU1007, TSXU835, TSXU836, TSXU840, TSXU904, TSXU904SL, TSXU905, TSXU905-1, TSXU944SL, TSXU963, TSXU9631, TSXU995</p>
--	---

B9022-016	Zenith Carburetor Rebuild Kit	\$24.99
------------------	--------------------------------------	----------------

	<p>Case Tractors Model 870, 930, 970 Replaces: Zenith - #K2039, K2040 Fits Carburetor: Zenith #10555, 10987, 11019, 11177, 11177A, 11177B, 11178, 11178A, 11178B, 11652, 11692, 11880, 12053, 12511, 12540, 12541, 12640, 12652, 12777, 12863, 12893, 12918, 12957, 12978, 13148, 13303, 13327, 13343, 13368, 13410, 13411, 13441, 13478, 13544, 13598, 13686</p>
---	--

B9023-003	Marvel-Schebler Carburetor Float	\$12.75
------------------	---	----------------

	<p>Case Tractors Model EXA-124, V, VA, VAB, VT3200, 148VA, 200B, 300, 300B, 310, 320, 350, 440, 480, 600 Replaces Carburetor: Marvel-Schebler Carburetor: #TSX-42, TSX-43, TSX-74, TSX-114, TSX-212, TSX-253, TSX-513, TSX-597, TSX-663, TSX-804, TSX-936, TSX-936SL, TSXU-831, TSXU-832, TSXU-833, TSXU-834 Case Carburetor: #018220AB, A-38242, A-38243, A-45779, 7G-11057, G-11057, VT-2072, VT-2475, VT-2632, VT-3593, VT-4062, VTA-4714 Replaces: Case: #B51772 Marvel Schebler: #30-600</p>
---	--

B9023-004	Marvel-Schebler Carburetor Float	\$19.95
------------------	---	----------------

	<p>Case Tractors Model 530, 540, 540C, 541, 541C, 640, 640C, 641, 641C Replaces Carburetor: Marvel-Schebler Carburetor: #TSX-798, TSX-799, TSXU-963 Case Carburetor: #G-45773, G-45774, G-46784 Replaces: Marvel Schebler: #30-739</p>
---	--

B9023-011	Zenith Carburetor Float	\$34.50
------------------	--------------------------------	----------------

	<p>Case Tractors Model C, CC, D, DC, 400, 500B, 510B, 511B, 600, 600B Replaces Carburetor: Zenith Carburetor: #8964, 8964A, 8964B, 12255, 12255A, 12329A, 13902 Replaces: Zenith: #C85-26</p>
---	--

B9023-012	Marvel-Schebler Carburetor Float	\$29.50
------------------	---	----------------

	<p>Case Tractors Model D, 400, 410B, 500B, 511B, 540B, 600B, 700, 710, 725, 730, 740, 810, 840 Replaces Carburetor: Marvel-Schebler Carburetor: #TSX-11, TSX-616, TSX-717, TSX-749, TSX-780, TSX-782, TSX-785, TSX-794, TSX-840, TSX-863 Replaces: Case: #B51773</p>
---	---

B9023-015	Zenith Carburetor Float	\$24.99
------------------	--------------------------------	----------------

	<p>Case Tractors Model S, SC, SC-3, SC-4, SI, SO, 300, 300B, 310B, 311, 311B, 312, 312B, 320, 320B, 400B, 410B, 411B, 420B, 430, 445, 470, 480, 500B, 510B, 511B, 530, 540, 541, 545, 570, 600B, 610B, 611B, 614B, 630, 640, 641, 642, 644, 770, 870, (Industrial) – W3, W5A, 310 Crawler, 430CK, 480 Loader, 480B, 480CK, 530 Construction King, 530CK, 580 Construction King, 580 Loader, 580B, 1845 Skid Steer, W5, W7E. Replaces: Case: B51359, B51773. Zenith: #C85-115, C85-115S Fits Carburetor: (various- see www.brillman.com)</p>
--	--

CARBURETOR ACCESSORIES

B9038-003	Carburetor Elbow Fuel Line Fitting with Strainer	\$7.99
	<p>Elbow Fuel Line Fitting with strainer for IHC carburetors. 1/8" Pipe to 1/4" Flare. Works with Carter UT Series and Various Marvel-Schebler Carburetors.</p> <p>Fits: Case - DC, SC, VAC, 300B, 430, 530, 730, 930, 1030, C, CC, CI, CO, D, DI, VC, VAI, DO, L, LA, LAI, LI, RC, S, SI, SO, VA, VAH, VAO, 200B, 210B, 211B, 70, 300, 310B, 311B, 400, 400B, 411B, 500, 500B, 511B, 570, 600B, 611B, 770, 830, 870, 700, 900, 970, 990, 995, 996, 1031, 1032, 1070, 1090, 1170, 1175, 1200, 1200TK, 1210, 1212, 1270, 1370, 1412, 1470TK, 2470, 2670, 3800, 4600, 580B, 47</p>	

B9038-007	2" Sediment Bowl Gasket	\$2.19
	<p>2" Outer Diameter, Bowl to Body; Fits a 1.28" Tall Glass Bowl Case Replaces: A11208 Fits (using/ 1.280" long glass bowl): D, DC, DC-3, DC-4, DCS, DH, DI, DO, DV, S, SC, SC-3, SC-4, SI, SO, VA, VAC, VAC-11, VAC-12, VAC-13, VAC-14, VAH, VAI, VAIW-3, VAO, VAO-15, VAS, VC (Gas, using/ 1.280" long glass bowl): 200 (Gas), 200B, 210, 210B, 211, 211B, 300, 300B, 310B, 311, 311B, 312, 312B, 400B, 410B, 411B, 430, 441, 470, 480, 500B, 510B, 511B, 530, 540, 541, 570, 580B, 600B, 610B, 611B, 614B</p>	

FUEL SEDIMENT BOWLS

B9036-001	Fuel Sediment Bowl	\$27.99
	<p>Has a 3/8" Pipe Inlet and a 1/8" Pipe Outlet. Bowl is 1.280" Long. Shallow Bowl has 90° Outlet Only. Case Replaces: #03990AB1, A30049, O3990AB1 Fits (Gas) - R, RC, V, VA, VAC, VAC-11, VAC-12, VAC-13, VAC-14, VAE, VAH, VAI, VAIW-3, VAO, VAS, VC, VI, VO, 200, 200B, 210, 210B, 211, 211B, 300, 300B, 310, 310B, 311, 311B, 312, 312B, 351, 400B, 410B, 411B, 420B, 430, 430CK, 441, 470, 480, 480B, 480CK, 500B, 510B, 511B, 530, 530CK, 530 Construction King, 540, 541, 570, 580, 580B, 580B Construction King, 580CK, 580 Construction King, 600B, 610B, 611B, 614B (for other fits: see www.brillman.com)</p>	

B9036-002	Fuel Sediment Bowl	\$34.99
	<p>Has a 3/8" Pipe Inlet, 1/8" Pipe Outlet, and a 2.315" tall glass bowl. Case Replaces: #A26615, O1933AB Fits (Gas using 2.315 Long Glass Bowl): 400, 700, 730, 740, 741, 742, 744, 830, 840, 841, L (to 1939), LI (to 1939) (...& Single Outlet): CC, CI, CO, R, RC (...& to SN: 4600027): LA, LAI</p>	
Parts for Sediment Bowl Above		
B9038-024	Connector w/ Female Fitting	\$8.99
B9038-008	2" Sediment Bowl Screen	\$3.99
B9038-012	Sediment Bowl Gasket	\$2.99

FUEL SYSTEM ACCESSORIES

B9038-009	Fuel Cap	\$10.99
	<p>Chrome Plated, 2.7" Outside Diameter, 1.88" Overall Tab Length, .25" Tab Width Case Replaces: A32119, G13271 Fits: 430, 431, 441, 470, 480, 530, 570, 580B, 730, 770, 870, 930, 970, 1030, 1030 Comfort King, 1031, 1032, 1070, 1090, 1170, 1175, 1270, 1370, 2470 (Serviceable): 200, 200B, 210, 210B, 211, 211B, 300, 300B, 301B, 310B, 311, 311B, 312, 312B, 400B, 410B, 411B, 500B, 510B, 511B, 600B, 610B, 611B, 614B, VA, VAC, VAC-11, VAC-12, VAC-13, VAC-14, VAH, VAI, VAIW, VAIW-3, VAO, VAO-15, VC (Gas SN: 8,248,495 & up and Diesel SN: 8,247,917 & later): 531, 540, 541, 545 (Gas/Diesel SN: 8,253,501 & up, using 2 7/8" O.D. Cap): 740, 741, 742, 744, 840, 841</p>	

CASE SKID STEER

SPARK PLUG WIRE SETS

Case 1700 with 148B Motor
4 Cyl. Tailored Spark Plug Wire Set

B1007-042	Original Type Cotton Braid Wire	\$26.00
B1007-042E	EPDM Wire	\$31.25
B1007-042S	Suppression Wire	\$31.25

Battery Ignition Tune-Up Parts

Case 1700 with Autolite/Prestolite Distributor #IAD-4101A, IAD-6003

B4100-004	\$14.75
------------------	----------------

PCR Kit

Includes: Points (#B4001-005), Condenser (#B4002-002), Rotor (#B4004-003)

Replaces: Points - #1-4, 1-8, 1-9, 1-20, 1-22, 1-45, IAD-3128S, IGP-3028ES, IGP3028FS, IGS2224L, IGW3028AS

Condenser - #2-23, 2-31, 2-32, 2-34, 2-38,

2-42, IAT-2015L, IAT-2015R, IAT-3076AS, IAT-3076BS, IAT-3076D, IAT-3076DS, IAT-3076L, IAT-3076LA, IAT-3076R, IAT-3076RA, IBB-2015L, IBB-2015R, IBB-2042-SS, IBB-2042SS-1, IBB-2042-SS3, IG-2671F, IGH-3076, IGW-3139, 2098058, 3420600 Rotor - #4-10

B4004-003	\$5.25
------------------	---------------

Rotor

Premium Grade, Made in USA

Replaces: #4-10

B4003-003	\$21.00
------------------	----------------

Distributor Cap

Made in the USA (Brass Contacts)

Replaces: #IG-1324D, 3-11, 3-12

*For 6- or 12-Volt Ignition Coils & Accessories, see p.44

Case Skid Steer 4 Cyl Gas Model 1845S
with Autolite/Prestolite Distributor # IDJ-4007

B4004-012	\$7.25
------------------	---------------

Rotor

Premium Grade, Made in the USA

Replaces: #4-86, 4-93

B4003-012	\$15.00
------------------	----------------

Distributor Cap

Made in the USA (Brass Contacts)

Replaces: #3-129, IBK-1009

ELECTRONIC IGNITION CONVERSION KITS

Replaces Points & Condenser



Case Skid Steer 4 Cyl. Gas Model 1700
with Autolite/Prestolite Distributor #IAD-4101A, IAD-6003

B9600-057	12 Volt Negative Ground	\$129.95
------------------	-------------------------	-----------------

B9600-057P12	12 Volt Positive Ground	\$147.45
---------------------	-------------------------	-----------------

B9600-057N6	6 Volt Negative Ground	\$147.45
--------------------	------------------------	-----------------

B9600-057P6	6 Volt Positive Ground	\$147.45
--------------------	------------------------	-----------------

Case Skid Steer 4 Cyl. Gas Model 1845S
with Autolite/Prestolite Distributor # IDJ-4007

B9600-196	12 Volt Negative Ground	\$165.45
------------------	-------------------------	-----------------



For Ignition Coils & Accessories, see p.44



ALTERNATORS

B6001-001	12 Volt Alternator (1 Wire)	\$112.75
------------------	------------------------------------	-----------------

63 Amp, Low Cut In, Specially Built For Tractors, Forklifts, & Other Low Engine Speed Applications

B6001-002	12 Volt Alternator (1 or/3 Wire)	\$118.75
------------------	---	-----------------

63 Amp, With 1 Wire Or 3 Wire For Warning Lamp On Automobiles & Trucks

Small ND Type

B6002-003	12 Volt Small Denso Alternator (1 Wire)	\$119.75
------------------	--	-----------------



40 Amp, 1 Wire Internal Regulator. Will Start Charging with a Much Lower Engine Speed. Comes with a 4 1/2" Housing Diameter, 3/8 To 1/2" Belt width & a 2 1/2" Pulley Diameter. Excellent for Converting a 6 Volt System to 12 Volt. Negative Ground Only & is Self-Excited

CATERPILLAR

TABLE OF CONTENTS

Spark Plug Wire Sets _____	95
Tune Up Parts _____	95
Magnetos _____	102
Alternators _____	102
Solenoids _____	102
Carburetor Rebuild Kits _____	102

SPARK PLUG WIRE SETS

Our Spark Plug Wire Sets Come Fully Assembled with the Proper Type Wire & Terminals.

They are Custom Tailored to Look & Fit Like Original Factory Equipment.

Varieties include:

Cotton Braid Wire: Copper Core with a Cotton Jacket.

EPDM Wire (E): Hi Performance Premium Conductor with a Tinned Copper Core, EPDM Silicone Insulation, and a Rubber Jacket.



Caterpillar 10

4 Cyl. Tailored Spark Plug Wire Set

B1008-001	Original Type Cotton Braid Wire	\$34.75
B1008-001E	EPDM Wire	\$37.75

Caterpillar 15

4 Cyl. Tailored Spark Plug Wire Set

B1008-002	Original Type Cotton Braid Wire	\$34.75
B1008-002E	EPDM Wire	\$37.75

Caterpillar 22

4 Cyl. Tailored Spark Plug Wire Set

B1008-003	Original Type Cotton Braid Wire	\$34.75
B1008-003E	EPDM Wire	\$37.75

Caterpillar 30

4 Cyl. Tailored Spark Plug Wire Set

B1008-004	Original Type Cotton Braid Wire	\$34.75
B1008-004E	EPDM Wire	\$37.75

Caterpillar 60

4 Cyl. Tailored Spark Plug Wire Set

B1008-005	Original Type Cotton Braid Wire	\$36.50
B1008-005E	EPDM Wire	\$39.75

Caterpillar 2 Ton

4 Cyl. Tailored Spark Plug Wire Set

B1008-006	Original Type Cotton Braid Wire	\$34.75
B1008-006E	EPDM Wire	\$37.75

Caterpillar D2, D4

2 Cyl. Tailored Spark Plug Wire Set

Early, with Pony Motor

B1008-007	Original Type PVC Wire	\$15.50
B1008-007E	EPDM Wire	\$18.75

Late, with Pony Motor

B1008-008	Original Type PVC Wire	\$16.50
B1008-008E	EPDM Wire	\$20.00

Caterpillar D6 with Pony Motor

2 Cyl. Tailored Spark Plug Wire Set

B1008-009	Original Type PVC Wire	\$17.75
B1008-009E	EPDM Wire	\$21.25

Caterpillar D8 with Pony Motor

2 Cyl. Tailored Spark Plug Wire Set

B1008-010	Original Type Cotton Braid Wire	\$19.75
B1008-010E	EPDM Wire	\$21.25

Caterpillar R2

4 Cyl. Tailored Spark Plug Wire Set

B1008-011	Original Type Cotton Braid Wire	\$34.75
B1008-011E	EPDM Wire	\$37.75

Caterpillar R5

4 Cyl. Tailored Spark Plug Wire Set



B1008-012	Original Type Cotton Braid Wire	\$34.75
B1008-012E	EPDM Wire	\$37.75

Caterpillar WD 10 with Pony Motor

2 Cyl. Tailored Spark Plug Wire Set

B1008-013	Original Type Cotton Braid Wire	\$17.25
B1008-013E	EPDM Wire	\$18.75

TUNE UP PARTS

Caterpillar 6- & 12-Volt Industrial Engines, Autolite/Prestolite Distributors #IBT-4701A, IBT-4701C		
	B4001-017	\$6.50
	Points Replaces: #IBP-2040L, IBP-3028BS, 1-33, 147V, 1-48	
	B4002-006	\$7.50
	Condenser Replaces: #2-31, 2-38, 2-42, 2-95, IAT-1125SS, IAT-3076BS, IBB-2042SS-1, IBB-2042-SS3, IG-3927F, IG-3927G, IG-3927K, IG-3927R,	
	B4003-074	\$26.25
	Cap Replaces: #3-128, IBT1111	

	B4004-012	\$7.25
	Rotor Premium Grade, Made in the USA Replaces: #4-86, 4-93	

with American Bosch Magneto #MRD-2A

	B4011-007	\$25.75
	Points Replaces: #BK52203	

	B4012-003	\$18.50
	Condenser Replaces: #CW5279	

	B4015-015	\$69.25
	Coil Replaces: #SM137	

	B4013-033	\$64.50
	Cap Replaces #DP52607, DP52610	

	B4014-013	\$15.75
	Rotor Replaces: #RT52288	

	B4016-013	\$5.75
	Cap Gasket Replaces: #GA5261	

Caterpillar D2, D4, D6, D7, D8 Pony Motor with American Bosch MJK 4/2 360B-47, 4/2 360C-410, MJK 4/2 360-311 Magnetos

	B4011-016	\$32.25
	Points Replaces: #BK52234	

	B4012-011	\$34.00
	Condenser Replaces: #CW52110	

	B4015-017	\$79.25
	Coil Replaces: #CL5298AS	

	B4013-034	\$49.75
	Cap Replaces #DP52442	

	B4014-016	\$37.75
	Rotor Replaces: # RT52154	

	B4017-048	\$7.91
	Cap Brush *3 Needed; Each Sold Separately* (not included with cap) Replaces: #BR521004	

	B4016-016	\$5.39
	Cap Gasket Replaces: #GA52148	

with American Bosch MRF Magnetos, including #MRF-4A & MRF-6A

	B4011-015	\$32.50
	Points Replaces: #CS521, AS3	

	B4012-012	\$22.50
	Condenser Replaces: #CW5291AS	

Caterpillar D2, D4 Pony Motor with WICO Magneto #XH2836,S (Caterpillar #4S6471)

	B4011-004	\$17.75
	Points Replaces: #1-5008, 1-5111, FXH-2100B, FXH-2400B, X5996	

	B4012-002	\$13.75
	Condenser Replaces: #2-5007, FXH-2024	

	B4013-027	\$55.75
	Cap Replaces: #3-5025, FXG-2002E-2	

	B4014-012	\$48.50
	Rotor Replaces: #4-5008, FXG-2308B	

	B4015-003	\$39.75
	Coil (Hot Coil) Replaces: #5-5011, AR12006, FXH2403, X5700, X5700B, X5700C	
	B4017-051	\$10.25
	WICO Impulse Catch Plate Replaces: #94-5070, FXH-210S-1	
	B4017-007	\$12.50
	Impulse Spring Replaces: #94-5016	

Did You Know?



Caterpillar, or CAT, got their name when company photographer Charles Clements was reported to have observed that the tractor crawled like a caterpillar.

	B4016-003	\$14.75
	Complete Gasket Set Includes # H2498 (B4016-002), B682 (B4016-001), G2501, G3861, A2492A, Replaces: #GK17	
	B4017-002	\$11.75
	Rear Ball Bearing Replaces: #C5949	
	B4017-041	\$16.00
	Coupling Impulse Spring Replaces: #D2565	
	B4016-005	\$1.75
	Flange Gasket Replaces: #SAE	
	B4017-001	\$2.75
	Coil Lead Replaces: #FMJL	

Caterpillar D12 with Fairbanks Morse #FMX-F2B36E Magnetos

	B4110-005	\$39.50
	PCR Kit Includes: Points (#B4011-003), Condenser (#B4012-001), Rotor (#B4014-001) Replaces: Points - #A2437A Condenser - #AXMR2433 Rotor - #M2765	
	B4013-031	\$54.00
	Cap Replaces: #D800	
	B4015-002	\$39.75
	Coil Replaces: #R2477C	
	B4016-001	\$2.75
	Cap Gasket (Outer) Replaces: #B682	
	B4016-002	\$2.75
	Cap Gasket (Inner) Replaces: #H2498	

with Fairbanks-Morse Magneto #FM-X1, FM-XF2, FM-X2C

	B4011-003	\$18.50
	Points Replaces: #A2437A	
	B4012-001	\$11.00
	Condenser Replaces: #AXMR2433	

with WICO Magneto #XH184

	B4011-004	\$17.75
	Points Replaces: #1-5008, 1-5111, FXH-2100B, FXH-2400B, X5996	
	B4012-002	\$13.75
	Condenser Replaces: #2-5007, X5614, X6916	
	B4017-040	\$2.75
	Condenser Clamp Replaces: #94-5167	

	B4013-004 Cap Includes #B4016-004 Replaces: #3-5014	\$36.75
	B4014-002 Rotor Replaces: #4-5010	\$23.50
	B4017-007 Impulse Spring Replaces: #94-5016	\$12.50
	B4016-004 Cap Gasket Replaces: #94-5076	\$2.25
	B4016-012 Striker Plate Gasket Replaces: #94-5154	\$2.25
	B9013-011 WICO Series X Nameplate Fits the WICO Series X magneto (Rivets included)	\$7.00

	B4017-051 WICO Impulse Catch Plate Replaces: #94-5070, FXH-210S-1	\$10.25
--	---	----------------

with WICO Magneto #XH1907

	B4011-004 Points Replaces: #1-5008, 1-5111, FXH-2100B, FXH-2400B, X5996	\$17.75
	B4013-026 Cap Includes #B4016-004 Replaces: #3-5013	\$47.00
	B4014-002 Rotor Replaces: #4-5010	\$23.50
	B4015-003 Coil (Hot Coil) Replaces: #5-5011, AR12006, FXH2403, X5700, X5700B, X5700C	\$39.75
	B4017-007 Impulse Spring Replaces: #94-5016	\$12.50
	B4017-051 WICO Impulse Catch Plate Replaces: #94-5070, FXH-210S-1	\$10.25

Caterpillar D12 with WICO Magneto #XH1906

	B4011-004 Points Replaces: #1-5008, 1-5111, FXH-2100B, FXH-2400B, X5996	\$17.75
	B4014-002 Rotor Replaces: #4-5010	\$23.50
	B4015-003 Coil (Hot Coil) Replaces: #5-5011, AR12006, FXH2403, X5700, X5700B, X5700C	\$39.75
	B4017-033 Wico Impulse Trip Dog Set Repair Kit Replaces: #90-5033	\$13.50
	B4017-007 Impulse Spring Replaces: #94-5016	\$12.50



with WICO Magneto #XH1908

	B4011-004 Points Replaces: #1-5008, 1-5111, FXH-2100B, FXH-2400B, X5996	\$17.75
	B4013-026 Cap Includes #B4016-004 Replaces: #3-5013	\$47.00
	B4014-002 Rotor Replaces: #4-5010	\$23.50

	B4015-003	\$39.75
	Coil (Hot Coil) Replaces: #5-5011, AR12006, FXH2403, X5700, X5700B, X5700C	
	B4017-033	\$13.50
	Wico Impulse Trip Dog Set Repair Kit Replaces: #90-5033	
	B4017-007	\$12.50
	Impulse Spring Replaces: #94-5016	
	B4017-051	\$10.25
	WICO Impulse Catch Plate Replaces: #94-5070, FXH-210S-1	

with WICO Magneto #XH2450, XH2450B, XH2450C, XH2450CS, XH2836, XH2836S, Caterpillar # 5M4071, 4S4671		
	B4011-004	\$17.75
	Points Replaces: #1-5008, 1-5111, FXH-2100B, FXH-2400B, X5996	
	B4012-002	\$13.75
	Condenser Replaces: #2-5007, X5614, X6916	
	B4013-027	\$55.75
	Cap Replaces: #FXG-2002E-2, 3-5025 Fits: XH2450B, XH2836S	
	B4014-012	\$48.50
	Rotor Replaces: #FXG-2308B, 4-5008 Fits: XH2450B, XH2836S, XH2842	
	B4015-003	\$39.75
	Coil (Hot Coil) Replaces: #5-5011, AR12006, FXH2403, X5700, X5700B, X5700C	
	B4017-007	\$12.50
	Impulse Spring Replaces: #94-5016	
	B4017-051	\$10.25
	WICO Impulse Catch Plate Replaces: #94-5070, FXH-210S-1	

Caterpillar D12 with WICO Magnetos #XHD2263, XHD2289, XH2781		
	B4011-004	\$17.75
	Points Replaces: #1-5008, 1-5111, FXH-2100B, FXH-2400B, X5996	
	B4012-002	\$13.75
	Condenser Replaces: #2-5007, X5614, X6916	
	B4013-026	\$47.00
	Cap Includes #B4016-004 Replaces: #3-5013	
	B4014-002	\$23.50
	Rotor Replaces: #4-5010	
	B4017-007	\$12.50
	Impulse Spring Replaces: #94-5016	
	B4016-004	\$2.25
	Cap Gasket Replaces: #94-5076	

Caterpillar D12 with WICO Magneto #XH2522B, XH2522 C, XH2601 Caterpillar # 4M4314, 5M2851, 8H9921		
	B4011-004	\$17.75
	Points Replaces: #1-5008, 1-5111, FXH-2100B, FXH-2400B, X5996	
	B4012-002	\$13.75
	Condenser Replaces: #2-5007, X5614, X6916	

	B4013-030 Cap Replaces: #3-5046, FXH-2302A-2	\$41.75
	B4015-003 Coil (Hot Coil) Replaces: #5-5011, AR12006, FXH2403, X5700, X5700B, X5700C	\$39.75
	B4017-007 Impulse Spring Replaces: #94-5016	\$12.50
	B4017-051 WICO Impulse Catch Plate Replaces: #94-5070, FXH-210S-1	\$10.25

	B4012-002 Condenser Replaces: #2-5007, X5614, X6916	\$13.75
	B4017-040 Condenser Clamp Replaces: #94-5167	\$2.75
	B4014-015 Rotor Replaces: #4-5015, XH	\$34.75
	B4015-003 Coil (Hot Coil) Replaces: #5-5011, AR12006, FXH2403, X5700, X5700B, X5700C	\$39.75
	B4017-007 Impulse Spring Replaces: #94-5016	\$12.50
	B4017-051 WICO Impulse Catch Plate Replaces: #94-5070, FXH-210S-1	\$10.25
	B4016-004 Cap Gasket Replaces: #94-5076	\$2.25
	B4016-012 Striker Plate Gasket Replaces: #94-5154	\$2.25
	B9013-011 WICO Series X Nameplate Fits the WICO Series X magneto (Rivets included)	\$7.00

with WICO Magneto #XH2541B, Caterpillar #9H3674

	B4011-004 Points Replaces: #1-5008, 1-5111, FXH-2100B, FXH-2400B, X5996	\$17.75
	B4012-002 Condenser Replaces: #2-5007, X5614, X6916	\$13.75
	B4015-003 Coil (Hot Coil) Replaces: #5-5011, AR12006, FXH2403, X5700, X5700B, X5700C	\$39.75
	B4017-007 Impulse Spring Replaces: #94-5016	\$12.50
	B4017-051 WICO Impulse Catch Plate Replaces: #94-5070, FXH-210S-1	\$10.25

Caterpillar D12 with WICO Magneto #XH2802 (CAT #1S3350)

	B4011-018 Points Replaces: #1-5090	\$20.50
	B4012-002 Condenser Replaces: #2-5007, X5614, X6916	\$13.75

	B4013-029	\$59.75
	Cap Replaces: #3-5052, FXH-2402C	
	B4014-015	\$34.75
	Rotor Replaces: #4-5015	
	B4015-003	\$39.75
	Coil (Hot Coil) Replaces: #5-5011, AR12006, FXH2403, X5700, X5700B, X5700C	
	B4017-007	\$12.50
	Impulse Spring Replaces: #94-5016	
	B4017-051	\$10.25
	WICO Impulse Catch Plate Replaces: #94-5070, FXH-210S-1	

with WICO Magneto #XH2803, XH2823
Caterpillar #3S2987, IS3350

	B4011-018	\$20.50
	Points Replaces: #1-5090	
	B4012-002	\$13.75
	Condenser Replaces: #2-5007, X5614, X6916	
	B4017-040	\$2.75
	Condenser Clamp Replaces: #94-5167	
	B4013-029	\$59.75
	Cap Replaces: #3-5052, FXH-2402C	
	B4014-015	\$34.75
	Rotor Replaces: #4-5015, XH	
	B4015-003	\$39.75
	Coil (Hot Coil) Replaces: #5-5011, AR12006, FXH2403, X5700, X5700B, X5700C	

	B4016-012	\$2.25
	Striker Plate Gasket Replaces: #94-5154	
	B4017-007	\$12.50
	Impulse Spring Replaces: #94-5016	
	B4017-051	\$10.25
	WICO Impulse Catch Plate Replaces: #94-5070, FXH-210S-1	
	B9013-011	\$7.00
	WICO Series X Nameplate Fits the WICO Series X magneto (Rivets included)	

Caterpillar D12 with WICO Magneto # XH2842,
Caterpillar # 4S6473

	B4011-004	\$17.75
	Points Replaces: #1-5008, 1-5111, FXH-2100B, FXH-2400B, X5996	
	B4012-002	\$13.75
	Condenser Replaces: #2-5007, X5614, X6916	
	B4013-028	\$78.50
	Cap Replaces: #FXG-2002G-2, 3-5054 Fits: XH2842	
	B4014-012	\$48.50
	Rotor Replaces: #FXG-2308B, 4-5008 Fits: XH2450B, XH2836S, XH2842	
	B4015-003	\$39.75
	Coil (Hot Coil) Replaces: #5-5011, AR12006, FXH2403, X5700, X5700B, X5700C	
	B4017-007	\$12.50
	Impulse Spring Replaces: #94-5016	
	B4017-051	\$10.25
	WICO Impulse Catch Plate Replaces: #94-5070, FXH-210S-1	

Rebuilt Magnetos

Our Rebuilt Magnetos are completely torn down, cleaned, & inspected. They will (at the minimum) have the following new parts: Points, Condenser, Coil, Coil Insulators, Lead-out Tower, & Outside Covers, plus any additional parts that are needed to make the unit look & perform like new.

They come with a 1-Year Limited Warranty.

Notes:

1. Unless otherwise specified, cost is exchange price.
2. A core charge (see below) will be charged to your credit card until we receive your good core.
3. A good core is considered a complete magneto with no cracks or weld repairs. Only good cores will be credited.

*Magnetos must be used with copper ignition wire.
Use of any other type will Void the Warranty.*

	#MJK4/2	Exchange	\$550.00
	180-311R	Outright	\$775.00
Rebuilt American Bosch MJK4/2 180-311R Magneto Fits Caterpillar: D7 & D8 Crawlers \$225 Core Charge			
	#MJK4/2	Exchange	\$550.00
	360B-47R	Outright	\$775.00
Rebuilt American Bosch MJK4/2 360B-47R Magneto Fits Caterpillar: D2 & D4 Crawlers; #42 & 48 Graders; D3400 & D4400 Power Units; #12, 112, & 212 Motor Graders; E34, E47, E48, E55, E57, E71, E72, E73, & E74 Engines *Compatible with MJK4/2 360_-47 Magnetos that replace the 'B' with another letter \$225 Core Charge			
	#MJK4/2	Exchange	\$550.00
	360C-410R	Outright	\$775.00
Rebuilt American Bosch MJK4/2 360C-410 Magneto Caterpillar Replaces: #9H4479 Fits: D6 Crawlers *Compatible with MJK4/2 360_-410 Magnetos that replace the 'C' with another letter. \$225 Core Charge			
	#XH2837R	Exchange	\$445.00
		Outright	\$670.00
Rebuilt WICO XH2837 Magneto \$225 Core Charge			

B8002-050	Voltage Regulator	\$139.75
	24-Volt, 16-20 Amps, USA Made Replaces: Caterpillar - #5L6614, 2M6497 Delco - #1119233, 1119237, 1119626, 1119177, 1119683 Fits: Wheel Loader 920, 930, 950, 3304 Track Loader 955	

Note: Due to modern battery design, voltage regulators can't be used to charge low or dead batteries. Doing so will destroy the voltage regulator and void the warranty.

ALTERNATORS

B6001-001	12 Volt Alternator (1 Wire)	\$112.75	
63 Amp, Low Cut In, Specially Built For Tractors, Forklifts, & Other Low Engine Speed Applications			
B6002-003	12 Volt Small Denso Alternator (1-Wire)	\$119.75	
40 Amp, 1 Wire Internal Regulator. Will Start Charging with a Much Lower Engine Speed. Comes with a 4 1/2" Housing Diameter, 3/8 To 1/2" Belt width & a 2 1/2" Pulley Diameter. Excellent for Converting a 6 Volt System to 12 Volt. Negative Ground Only & is Self-Excited			

SOLENOIDS

B5007-021	Delco 24V 40MT & 50MT Solenoid	\$75.50
	24 Volt Rated Solenoid for Delco 40MT & 50MT Direct Drive Starters with 4 Terminals. Replaces: Delco - #1115526, 1119804, 1119832, 1119848, 1119849 Caterpillar - #4M-1812, 4R-7057, 7T-8858 Fits: Caterpillar - D5, D6, D7, 814, 920, 936, 950, 955L	
B5007-024	Delco 12 Volt Solenoid	\$109.50
	12 Volt Rated Solenoid for Delco 40MT & 50MT Direct Drive Starters with 4 Terminals. Replaces: Delco - #1119835, 1119853, 1119862, 1119879, 1119895 Caterpillar - #2N1973, 3T5045, 7L6586, 9X8236	

CARBURETOR REBUILD KITS

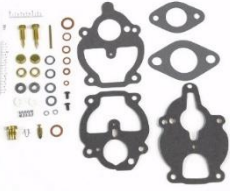
B9022-008	Zenith Carburetor Rebuild Kit	\$26.95
	Caterpillar Tractors With 162 Engine Fits Zenith Carburetor: Tractors with 162 Engine: #12384, 12556, Tractors with F244, 266 Engines: #12991, 14991	

CENTAUR

SPARK PLUG WIRE SETS

Our Spark Plug Wire Sets Come Fully Assembled with the Proper Type Wire & Terminals.

They are Custom Tailored to Look & Fit Like Original Factory Equipment.

Varieties include:

Cotton Braid Wire: Copper Core with a Cotton Jacket.

PVC Wire: Copper Core with a Rubber Jacket.

EPDM Wire (E): Hi Performance Premium Conductor with a Tinned Copper Core, EPDM Silicone Insulation, and a Rubber Jacket.

Suppression Wire (S): for Electronic Ignition and is Spiral Wound, Ultra Low-Ohm, with EPDM Silicone Insulation and a Rubber Jacket.

Cotton Braid Suppression Wire (CS): also for Electronic Ignition, as Suppression Wire, but has an additional layer of Cotton Braid & Lacquer to replicate the vintage look, as well.



Centaur KV22 with Leroi #D123 Engine

6 Cyl. Tailored Spark Plug Wire Set

B1009-001	Original Type PVC Wire	\$26.25
B1009-001E	EPDM Wire	\$28.75

Fuel Sediment Bowls

B9036-001	Fuel Sediment Bowl	\$27.99
 <p>Has a 3/8" Pipe Inlet and a 1/8" Pipe Outlet. Bowl is 1.280" Long. Shallow Bowl has 90° Outlet Only. Centaur Fits: KV Models</p>		

Did You Know?

During World War II, essentially all of Chrysler's facilities were devoted to building military vehicles and systems.

CHRYSLER INDUSTRIAL

SPARK PLUG WIRE SETS

215 Chrysler Industrial Engine

6 Cyl. Tailored Spark Plug Wire Set

B1010-003	Original Type PVC Wire	\$32.50
B1010-003E	EPDM Wire	\$39.25
B1010-003S	Suppression Wire	\$39.25

218 Chrysler Industrial Engine for Co-op 3

6 Cyl. Tailored Spark Plug Wire Set

B1010-005	Original Type EPDM Wire	\$39.25
------------------	--------------------------------	----------------

230 Chrysler Industrial Engine

IND30/1533/1

6 Cyl. Tailored Spark Plug Wire Set

B1010-004	Original Type PVC Wire	\$32.50
B1010-004E	EPDM Wire	\$39.25
B1010-004S	Suppression Wire	\$39.25

236 Chrysler Industrial Engine

6 Cyl. Tailored Spark Plug Wire Set

B1010-001	Original Type PVC Wire	\$32.50
B1010-001E	EPDM Wire	\$39.25
B1010-001S	Suppression Wire	\$39.25

250 Chrysler Industrial Engine

6 Cyl. Tailored Spark Plug Wire Set

B1010-002	Original Type PVC Wire	\$32.50
B1010-002E	EPDM Wire	\$39.25
B1010-002S	Suppression Wire	\$39.25

CARBURETOR REBUILD KITS

B9022-019	Carter Carburetor Rebuild Kit	\$39.75
Chrysler Engine Model 230", 251", 265" Carter Carburetor: #E7R1		

B9022-008	Zenith Carburetor Rebuild Kit	\$26.95
Chrysler Engine Model 32, T112, T125, 1.6 Liter Zenith Carburetor: #9698, 13004, 13851, 14544 Chrysler Carburetor: #4142128		

B9022-009	Zenith Carburetor Rebuild Kit	\$27.99
Chrysler Engine Model 32, T78, 218", 318" Zenith Carb.: #10608, 10608A, 10608B, 10608C, 10888, 11483, 11885, 11885A, 11885B, 11622, 11644, S496, S496A Chrysler Carb.: #995200, 1140252, 1316376, 1533324, 1551519		

B9022-011	Zenith Carburetor Rebuild Kit	\$24.99
Chrysler Engine Model 30 Zenith Carburetor: #12730, 12731, 14992 Chrysler Carburetor: #2125827, 21258856		

CLETRAC

SPARK PLUG WIRE SETS

Our Spark Plug Wire Sets Come Fully Assembled with the Proper Type Wire & Terminals.

They are Custom Tailored to Look & Fit Like Original Factory Equipment.



Varieties include:

Cotton Braid Wire: Copper Core with a Cotton Jacket.

EPDM Wire (E): Hi Performance Premium Conductor with a Tinned Copper Core, EPDM Silicone Insulation, and a Rubber Jacket.

Suppression Wire (S): for Electronic Ignition and is Spiral Wound, Ultra Low-Ohm, with EPDM Silicone Insulation and a Rubber Jacket.

Cletrac AG6 with Continental F226 Engine

6 Cyl. Tailored Spark Plug Wire Set

B1011-001	Original Type Cotton Braid Wire	\$38.25
B1011-001E	EPDM Wire	\$41.00

Cletrac HG with Hercules IXK3 Engine

4 Cyl. Tailored Spark Plug Wire Set

B1011-002	Original Type Cotton Braid Wire	\$22.75
B1011-002E	EPDM Wire	\$24.50

Cletrac BG with Hercules JXB Engine

6 Cyl. Tailored Spark Plug Wire Set

B1011-003	Original Type Cotton Braid Wire	\$35.75
B1011-003E	EPDM Wire	\$39.25
B1011-003S	Suppression Wire	\$39.25
B1011-003CS	Cotton Suppression Wire	\$62.00

BATTERY CABLES



Our Battery Cables are made from the Proper Gauge Copper, as either Black Cotton Braided Wire or PVC Wire (whichever is correct for the application), using Soldered & Heat Sealed Brass or Copper Terminals.

Cletrac General GG



B2011-001	Positive Battery Cable	\$33.50
B2011-002	Negative Battery Cable	\$36.50
B2011-003	Switch To Starter Cable	\$66.75

Cletrac HG

B2011-004	Positive Battery Cable	\$68.50
B2011-005	Negative Battery Cable	\$55.50
B2011-006	Switch To Starter Cable	\$70.75

TUNE UP PARTS (See Oliver)

GAUGES

B9025-002	Ammeter 20-0-20	\$19.99
	Does not have a logo Dimensions: Fits in 2" Diameter Hole 1.850" From Post to Bottom of Bezel	
B9025-005	Ammeter 30-0-30	\$19.99
	Does not have a logo Dimensions: Fits in a 2" Diameter Hole 1.740" From Top of Post to Bottom of Bezel	

SWITCHES

Universal Battery Ignition/Lights

B5002-001	2 Position Push/Pull Switch	\$7.75
	OFF/ON Universal 2 Position Push/Pull 2 Screw Terminals Mounting Stem 3/8"-32 Thread Knob #10/32 Thread	

Magneto Ignition Switches

B5002-004	Heavy Duty Push/Pull Magneto Switch	\$8.25
	ON/OFF (2 Position) Push/Pull Magneto Switch 2 Screw Terminals Mounting Stem 3/8"-32 Thread Knob #10/32 Thread	

Light Switches

B5002-005	3-Position Push/ Pull Switch	\$29.75
	Low Charge/High Charge/Lights (3 Position Switch) 3 Screw Type Mounting Stem .8" Thread Knob #10/32 Thread Premium Quality Made by an OEM Manufacturer	

Key Switches

B5003-001	2 Position Battery Key Switch	\$14.75
	Universal OFF/ON 2 Position Key Switch for Battery Ignition 2 Screw Terminals Mounting Stem 3/4"-20 Thread	

REPLACEMENT MAGNETOS

Rebuilt Magnetos

Our Rebuilt Magnetos are completely torn down, cleaned, & inspected. They will (at the minimum) have the following new parts: Points, Condenser, Coil, Coil Insulators, Lead-out Tower, & Outside Covers, plus any additional parts that are needed to make the unit look & perform like new.

They come with a 1-Year Limited Warranty.

Notes:

1. Unless otherwise specified, cost is exchange price.
2. A core charge (see below) will be charged to your credit card until we receive your good core.
3. A good core is considered a complete magneto with no cracks or weld repairs. Only good cores will be credited.

*Magnetos must be used with copper ignition wire.
Use of any other type will Void the Warranty.*

	XH1113R	Exchange	\$445.00
		Outright	\$645.00
Rebuilt WICO Magneto 4 Cyl. Flange Mount Core Charge: \$200			

ALTERNATORS

B6001-001	12 Volt Alternator (1 Wire)	\$112.75	
63 Amp, Low Cut In, Specially Built For Tractors, Forklifts, & Other Low Engine Speed Applications			
B6001-005	6 Volt Alternator (1 Wire, Positive Ground)	\$166.50	
6 Volt, 40 Amp Alternator with Positive Ground, 1 Wire, 3/8" pulley			

Small ND Type

B6002-003	12 Volt Small Denso Alternator (1 Wire)	\$119.75
	40 Amp, 1 Wire Internal Regulator. Will Start Charging with a Much Lower Engine Speed. Comes with a 4 1/2" Housing Diameter, 3/8 To 1/2" Belt width & a 2 1/2" Pulley Diameter. Excellent for Converting a 6 Volt System to 12 Volt. Negative Ground Only & is Self-Excited	

COCKSHUTT/ CO-OP

TABLE OF CONTENTS

Spark Plug Wire Sets	106
Battery Cables	106
Wire Harnesses	107
Tune Up Parts	107
Electronic Ignition Conversion Kits	109
Gauges	109
Switches	110
Starter Switches/ Solenoids	111
Cutout Relays & Voltage Regulators	112
Brush Sets,	112
Identification Tags	112
Alternators, Lights & Light Parts	113
Auxiliary Plugs & Sockets	115
Carburetor Rebuild Kits	116
Carburetor Floats	117
Carburetor Accessories	117
Fuel Sediment Bowls	117

SPARK PLUG WIRE SETS

Our Spark Plug Wire Sets Come Fully Assembled with the Proper Type Wire & Terminals.

They are Custom Tailored to Look & Fit Like Original Factory Equipment.

Varieties include:

Cotton Braid Wire: Copper Core with a Cotton Jacket.

PVC Wire: Copper Core with a Rubber Jacket.

EPDM Wire (E): Hi Performance Premium Conductor with a Tinned Copper Core, EPDM Silicone Insulation, and a Rubber Jacket.

Suppression Wire (S): for Electronic Ignition and is Spiral Wound, Ultra Low-Ohm, with EPDM Silicone Insulation and a Rubber Jacket.

Cotton Braid Suppression Wire (CS): also for Electronic Ignition, as Suppression Wire, but has an additional layer of Cotton Braid & Lacquer to replicate the vintage look, as well.



Cockshutt 20

4 Cyl. Tailored Spark Plug Wire Set

B1012-001	Original Type Cotton Braid Wire	\$22.75
B1012-001E	EPDM Wire	\$24.50
B1012-001S	Suppression Wire	\$24.50
B1012-001CS	Cotton Suppression Wire	\$39.00

Cockshutt 30, CO-OP E3

4 Cyl. Tailored Spark Plug Wire Set

B1012-002	Original Type Cotton Braid Wire	\$22.75
B1012-002E	EPDM Wire	\$24.50
B1012-002S	Suppression Wire	\$24.50
B1012-002CS	Cotton Suppression Wire	\$39.00

Cockshutt 40 with Buda #6B230 Engine

6 Cyl. Tailored Spark Plug Wire Set

B1012-003	Original Type Cotton Braid Wire	\$32.50
B1012-003E	EPDM Wire	\$35.25
B1012-003S	Suppression Wire	\$35.25
B1012-003CS	Cotton Suppression Wire	\$55.75

Cockshutt 50

6 Cyl. Tailored Spark Plug Wire Set

B1012-004	Original Type Cotton Braid Wire	\$32.50
B1012-004E	EPDM Wire	\$35.25
B1012-004S	Suppression Wire	\$35.25
B1012-004CS	Cotton Suppression Wire	55.75

Cockshutt 80 (up to Serial #10,992)

4 Cyl. Tailored Spark Plug Wire Set

B1012-005	Original Type Cotton Braid Wire	\$23.75
B1012-005E	EPDM Wire	\$26.00

Cockshutt 80 (Serial #10,993 & Up)

4 Cyl. Tailored Spark Plug Wire Set

B1012-006	Original Type Cotton Braid Wire	\$23.75
B1012-006E	EPDM Wire	\$26.00

BATTERY CABLES



Our Battery Cables are made from the Proper Gauge Copper, as either **Black Cotton Braided Wire** or **PVC Wire** (whichever is correct for the application), using Soldered & Heat Sealed Brass or Copper Terminals.

Cockshutt 20

B2012-001	Negative Battery Cable	\$36.75
B2000-006	Positive Ground Strap	\$13.50
B2012-002	Switch To Starter Cable	\$53.25

Cockshutt 30, CO-OP E3

B2012-011	Negative Battery Cable	\$36.50
B2000-006	Positive Ground Strap	\$13.50

Cockshutt 80

B2012-003	Negative Battery Cable	\$47.50
B2000-006	Positive Ground Strap	\$13.50
B2012-004	Switch To Starter Cable	\$33.75

Cockshutt 540

B2012-005	Negative Battery Cable	\$39.50
B2000-007	Positive Ground Strap	\$14.50

Cockshutt 550

B2012-006	Negative Battery Cable	\$52.00
B2000-007	Positive Ground Strap	\$14.50

Cockshutt 560 Diesel

B2012-007	Negative Battery Cable	\$54.25
B2000-007	Positive Ground Strap	\$14.50
B2012-008	Switch To Starter Cable	\$30.25
B2012-009	Battery To Battery Jumper	\$35.00

Cockshutt 570 Diesel

B2012-010	Negative Battery Cable	\$63.75
B2000-007	Positive Ground Strap	\$14.50
B2012-009	Battery To Battery Jumper	\$35.00

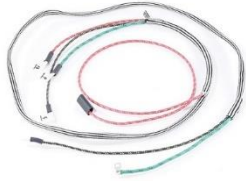

WIRING HARNESSSES

Our Wire Harnesses are made with our **premium cotton braid and/or PVC wire**.

They have the **correct gauge, color, wire, & fuse holders** (if needed).

All terminals are **soldered according to the original**.

(Harnesses do not include Battery Cables & Spark Plug Wires; however, we can supply these as separate products.)

NO HIDDEN COSTS, NOTHING EXTRA TO BUY!

CO-OP E2

B3012-003	Complete Wire Harness	\$137.50
------------------	-----------------------	-----------------

CO-OP E3

B3012-004	Complete Wire Harness	\$137.50
B3012-002	Complete Wire Harness (Farmers Union)	\$131.50

Cockshutt 20

B3012-003	Complete Wire Harness	\$137.50
------------------	-----------------------	-----------------

Cockshutt 30

B3012-004	Complete Wire Harness	\$137.50
------------------	-----------------------	-----------------

Note

When ordering, please specify **Year** or **Serial Number**, Magneto/Distributor, & Regulator/Cut Out Relay.

Some Harnesses were originally made with PVC Wire & Braided; others were made with PVC Wire & Taped.

In those cases, we build them the **Original Way**.

TUNE UP PARTS

Cockshutt 70 & 570 with Delco Distributor

	B4100-001	\$10.50
	PCR Kit Includes: Points (#B4001-001), Condenser (#B4002-001), Rotor (#B4004-002) Replaces: Points - #D100HP, 1855720 Condenser - #1928111, D-203, 1869704, D-200 Rotor - #820445, D400	
	B4004-002	\$5.75
	Rotor Replaces: #820445, D400	
	B4003-002	\$20.25
	Distributor Cap Premium Grade, Made in the USA (Brass Contacts) Replaces: #824735, D301	

	B4006-001	\$9.99
	Dust Cover Replaces: #1900119	
	B4007-001	\$11.95
	Cap Clip Short Mount, 1 Used Replaces: #1889967, 1847289, 453844, 453461	
	B4007-002	\$11.95
	Cap Clip Long Mount, 1 Used Replaces: #1889967, 1889999, 453844, 453461	
	B4008-001	\$14.99
	Distributor Insulator Replaces: #1904376	
	B4009-001	\$25.99
	Distributor Bushing & Shim Kit	

*For 6- or 12-Volt Ignition Coils & Accessories, see p.44

Cockshutt 20, 30, 35, 550 & CO-OP E2, E3 with Prestolite Distributor		
	B4001-005	\$9.75
	Points Replaces: #1-4, 1-8, 1-9, 1-20, 1-22, 1-45, IAD-3128S, IGP-3028ES, IGP3028FS, IGS2224L, IGW3028AS	
	B4002-006	\$7.50
	Condenser Replaces: ##2-31, 2-38, 2-42, 2-95, IAT-1125S, IAT-3076BS, IBB-2042SS-1, IBB-2042-SS3, IG-3927F, IG-3927G, IG-3927K, IG-3927R,	
	B4004-003	\$5.25
	Rotor Premium Grade, Made in USA Replaces: #4-10	
	B4003-003	\$21.00
	Distributor Cap Made in the USA (Brass Contacts) Replaces: #IG-1324D, 3-11, 3-12	

*For 6-Volt Ignition Coils & Accessories, see p.44

Cockshutt 40, 50, Co-Op E4 with Autolite/ Prestolite Distributor #IAD-6001		
	B4001-005	\$9.75
	Points Replaces: #1-4, 1-8, 1-9, 1-20, 1-22, 1-45, IAD-3128S, IGP-3028ES, IGP3028FS, IGS2224L, IGW3028AS	
	B4002-006	\$7.50
	Condenser Replaces: #2-31, 2-38, 2-42, 2-95, IAT-1125S, IAT-3076BS, IBB-2042SS-1, IBB-2042-SS3, IG-3927F, IG-3927G, IG-3927K, IG-3927R,	
	B4004-007	\$8.25
	Rotor Premium Grade, Made in the USA Replaces: #4-19	
	B4003-007	\$25.00
	Distributor Cap Premium Grade, Made in the USA (Brass Contacts) Replaces: #IGC-1107S, 3-23	

*For 6-Volt Ignition Coils & Accessories, see p.44

Cockshutt 540 with Cont. F-162, 550 with Delco Distributor		
	B4100-001	\$10.50
	PCR Kit Includes: Points (#B4001-001), Condenser (#B4002-001), Rotor (#B4004-002) Replaces: Points - #D100HP, 1855720 Condenser - #1928111, D-203, 1869704, D-200 Rotor - #820445, D400	
	B4004-002	\$5.75
	Rotor Replaces: #820445, D400	
	B4003-001	\$13.50
	Distributor Cap Premium Grade, Made in the USA (Brass Contacts) Replaces: #811735, D300	
	B4006-001	\$9.99
	Dust Cover Replaces: #1900119	
	B4007-001	\$11.95
	Cap Clip Short Mount, 1 Used Replaces: #1889967, 1847289, 453844, 453461	
	B4007-002	\$11.95
	Cap Clip Long Mount, 1 Used Replaces: #1889967, 1889999, 453844, 453461	
	B4008-001	\$14.99
	Distributor Insulator Replaces: #1904376	
	B4009-001	\$25.99
	Distributor Bushing & Shim Kit	

*For 6- or 12-Volt Ignition Coils & Accessories, see p.44

Cockshutt 570 with Prestolite Distributor		
	B4001-005	\$9.75
	Points Replaces: #1-4, 1-8, 1-9, 1-20, 1-22, 1-45, IAD-3128S, IGP-3028ES, IGP3028FS, IGS2224L, IGW3028AS	
	B4002-006	\$7.50
	Condenser Replaces: #2-31, 2-38, 2-42, 2-95, IAT-1125S, IAT-3076BS, IBB-2042SS-1, IBB-2042-SS3, IG-3927F, IG-3927G, IG-3927K, IG-3927R,	
	B4004-007	\$8.25
	Rotor Premium Grade, Made in the USA Replaces: #4-19	
	B4003-007	\$15.50
	Distributor Cap Premium Grade, Made in the USA (Brass Contacts) Replaces: #IGC-1107S, 3-23	

*For 12-Volt Ignition Coils & Accessories, see p.44

ELECTRONIC IGNITION CONVERSION KITS

Replaces Points & Condenser



Cockshutt 20, 30, 35 & CO-OP E3		
B9600-057	12 Volt Negative Ground	\$129.95
B9600-057P12	12 Volt Positive Ground	\$147.45
B9600-057N6	6 Volt Negative Ground	\$147.45
B9600-057P6	6 Volt Positive Ground	\$147.45

Cockshutt 40, 50		
B9600-064	12 Volt Negative Ground	\$134.45
B9600-064P12	12 Volt Positive Ground	\$147.45
B9600-064P6	6 Volt Positive Ground	\$147.45

Cockshutt 70 (with Delco Distributor)		
B9600-255LS	12 Volt Negative Ground	\$162.45
B9600-255LSP12	12 Volt Positive Ground	\$175.45
B9600-255LSP6	6 Volt Positive Ground	\$175.45

Cockshutt 540 with Cont. F-162 550 with Delco Distributor & Clip On Cap		
B9600-006	12 Volt Negative Ground	\$147.45
B9600-006P12	12 Volt Positive Ground	\$165.45

Replacement Distributors

1112587N	New Delco #1112587 Distributor	\$345.00
 <p>Brand New Delco Distributor #1112587. Has tachometer cable connection. Fits: Cockshutt - 1550, 1555, 1600, 1650, 1655, 1750, 1755, 1800, 1850, 1855 Tractors</p>		
1112587R	Rebuilt Delco #1112587 Distributor	\$325.00 outright \$225.00 exchange with \$100 core
 <p>Rebuilt Delco Distributor #1112587 Does <u>not</u> have tachometer cable connection. Fits: Cockshutt - 1550, 1555, 1600, 1650, 1655, 1750, 1755, 1800, 1850, 1855 Tractors</p>		

GAUGES

Ammeters, Universal

B9025-002	Ammeter 20-0-20	\$19.99
	Cockshutt Fits: 40D4 Golden Eagle, Golden Arrow, Golden Eagle, 20, 30, 35, 40, 50, Co-Op: E2, E3, E4, E5	
B9025-005	Ammeter 30-0-30	\$19.99
	Dimensions: Fits in a 2" Diameter Hole 1.740" From Top of Post to Bottom of Bezel	
B9025-008	Ammeter 60-0-60	\$19.99
	Uses threaded terminals and is dash mounted Used with 12-Volt Alternator Systems Dimensions:Fits in 2" Diameter Hole Measures 1.765" from Top of Post to Bottom of Bezel	

Oil Pressure Gauges

B9025-004	Universal Oil Pressure Gauge (0-50 PSI)	\$21.99
	<p>1/8" NPT Male Threads Has studs & a bracket Dash mounted Requires a 2" diameter hole. Fits: Cockshutt: 20, 30, 35 Blackhawk, 40, 40 Blackhawk, 40D4 Golden Eagle, 40PD Golden Eagle, 50, 50 Blackhawk,</p>	<p>550, 560, 570 Co-Op: E2, Co-Op: E3, E4, E5</p>

B9025-001	Universal Oil Pressure Gauge (0-80 PSI)	\$24.99
	<p>1/8" NPT Male Threads Has studs & a bracket Dash mounted Requires a 2" diameter hole. Fits: Cockshutt: 20, 30, 40, 40D4 Golden Eagle, 40PD Golden Eagle, 50, 550, 560, 570</p>	<p>Co-Op: E2, E3, E4, E5 (& others using 80 Lb. Gauge)</p>

Oil Pressure Gauge, Line Kit

B9026-001	Oil Pressure Gauge Line Kit	\$29.99
	<p>6 FT copper 1/8" line Kit includes: (x2) 5/16 - 24 UNF nuts (x2) compression sleeves (x1) 1/8 - 27 NPTF female to 5/16" - 24 UNF male adapter --- Note: Depending on application customer may be required to purchase other fittings.</p>	

B9026-004	Oil Pressure Gauge 1/4" to 1/8" NPT Adapter Fitting	\$15.99
	<p>Adapter Fitting for Oil Gauges – 1/4" to 1/8" NPT. Cockshutt/CO-OP Fits: Co-Op with Buda Over Head Valve Engine: E3, E4, E5, Co-Op with Continental F124: E2, Cockshutt: 20, 30, 35, 40, 50, 540, 550, 560, 570, GOLDEN ARROW, Oliver Built Cockshutt Tractor: 550</p>	

Water Temperature Gauges, Universal

B9025-006	Water Temperature Gauge	\$34.99
	<p>Includes an Aluminum Sealing Washer to Seal Probe. It has a Chrome Bezel with White, Green, Red Zones on a Black Gauge Face. Has a 1/2" NPT Pipe Bushing and Probe Length of 1.279". Cockshutt (CO-OP) Fits: [GOLDEN ARROW, GOLDEN EAGLE, 20, 30, 35, 550, 560 (And Other Models Using 60" Capillary Lead)], [Co-Op: E2, E3 (And Other Models Using 60" Capillary Lead)], Oliver Built Cockshutt: 60 (And Other Models Using 60" Capillary Lead)</p>	

B9025-007	Universal Water Temperature Gauge	\$34.99
	<p>Dash-mounted (parts included), 72" long heavy duty capillary tube included (check length before ordering) Cockshutt (CO-OP) Fits: [Co-Op: E2, E3, E4, E5 (And Others Using 72" Or Shorter Capillary Lead)], [Cockshutt: 20, 30, 35 Blackhawk, 40, 40 Blackhawk, 40D4 Golden Eagle, 40PD Golden Eagle, 50, 50 Blackhawk, 550, 560, 570 (And Others Using 72" Or Shorter Capillary Lead)], [Oliver Built Cockshutt: 60, 660, 70, 80, 90, 950, 99, 990, 995, SUPER 99 (And Others Using 72" Or Shorter Capillary Lead)]</p>	

Tachometer Drive Cable

B9026-006	63" Tachometer Drive Cable	\$32.99
	<p>Restoration Quality. Drive Cable for Tachometers. Measures 63" Outer Sheath Length. 5/8"-18 x 7/8"-18 Threads. Cockshutt Fits: 560 Replaces: #T18571, T18573, TO18314</p>	

SWITCHES & KNOBS

B5001-009	Combo Light Switch Knob	\$6.99
	<p>Fits #B9017-010, B9016-018, B9016-032, B9016-033. Also fits original equipment combo rear lights when 'handle' style knob is required. Cockshutt (CO-OP) Fits: Co-Op with Buda Over Head Valve Engine: E3, E4, E5, Co-Op with Continental F124: E2, Cockshutt: 20, 30, 35, 35 Blackhawk, 40, 40 Blackhawk, 40D4 Golden Eagle, 40PD Golden Eagle, 50, 50 Blackhawk, 550, 560, 570, Oliver Built Cockshutt Tractor: 550</p>	

Push/Pull Switches

B5002-001	2 Position Push/Pull Switch	\$7.75
	OFF/ON Universal 2-Position Push/Pull Switch 2 Screw Terminals Mounting Stem 3/8"-32 Thread Knob #10/32 Thread	

B5002-005	3-Position Push/ Pull Switch	\$29.75
	Low Charge/High Charge/Lights 3-Position Switch 3 Screw Terminals Mounting Stem .8" Thread Knob #10/32 Thread Premium Quality Made by the OEM Manufacturer Cockshutt Replaces: #TO7524 Fits: 30, 40, 50 Co-Op with Buda Overhead Valve Engine: E3, E4, E5	

B5002-004	Heavy Duty Push/Pull Magneto Switch	\$8.25
	ON/OFF 2-Position Push/Pull Magneto Switch 2 Screw Terminals Mounting Stem 3/8"-32 Thread Knob #10/32 Thread	

Key Switches

B5003-001	2 Position Battery Key Switch	\$14.75
	Universal OFF/ON 2-Position Key Switch (For Battery Ignition) 2 Screw Terminals Mounting Stem 3/4"-20 Thread	

B5003-005	4 Position Ignition Key Switch	\$39.99
	Can replace the 4 Terminal Switch. 2 Battery Terminals 5 Spade Terminals OEM Style Delco Remy 995" Diameter Threaded End. Includes 2 Keys & Jam Nut Cockshutt Replaces: #T18021B Fits: 540, 550, 560, 570	

B5003-006	Ignition Key	\$4.99
	Key for Part Above, #B5003-005. Brass Finish Fits Listed Models Using Delco Switch Cockshutt Replaces: #MAO836 Fits: 540, 550, 560, 570	

B5003-008	Ignition Key Switch	\$24.99
	Includes 2 Keys, 2 Spade Terminals Designed for 0.800" hole diameter. Cockshutt Replaces: #MXS204 Fits: 40D4 Golden Eagle, 40PD Golden Eagle, 20, 30, 35, 40, 50 Co-Op with Continental F124 E2, Co-Op w/ Buda Over Head: E3, E4, E5	

Momentary Switches

B5004-003	Momentary Push Switch	\$15.75
	Manual Push Button Solenoid Switch with Rubber Protected Cap 2 Screw Terminals Mounting Stem 5/8"-32 Thread Cockshutt Replaces: #T18524, TO18117, TO7803, TG07803 Fits (Starter Switch or Manifold Preheat switch) - 30D, 35, 40, 50, 550D, 560D, 570D (& Co-Op with Buda Over Head Valve Engine) - E4, E5	

STARTER SWITCHES

(MECHANICAL)

B5006-001	Starter Switch (Long Shaft)	\$12.75
	6 or 12 Volt Panel Mounted Manual Push Start Switch Replaces: Delco - #192119, D900, 450C Prestolite - #15-121, 15-122, 15-409, 15-45, 15-47, 15-50, 15-51, SW-2916, SW-4001, SW-4002, SW-4005, SW-4010, SW-4013, SW-4015, SW-4017, SW-4101, SWX-47 Fits: Cockshutt - Various Models	

SOLENOIDS

B5007-002	12 Volt Solenoid	\$17.50
	12 Volt, 3 Terminal Solenoid Curved Mounting Bracket Fits: Cockshutt/CO-OP - 30, 40, 50, 540, 550, 570 Gas	

B5007-010	12 Volt Solenoid (Manual Push Button)	\$17.50
	12 Volt, 3 Terminal Solenoid Curved Mounting Bracket Manual Push Button. Replaces: Autolite - SAE-4005, 15-60, SAW-4201 Fits: Cockshutt/CO-OP - 30, 40, 50, 540, 550, 570 Gas	

B5007-004	12 Volt Solenoid	\$23.75
	Curved Bracket & 4 Terminals Used with 30 & 35 MT Delco Starters Fits: Cockshutt - 560 (Diesel (sn C07401 & up), 570 (Diesel (sn DO10001 & up) Replaces: Delco : #1119890, 1119912, 1119885, 1119877, 1119935, 1119882, 1119906, D953, D985, 1119833, 1119883, 1115537, 1119978, 1115582, 1119778, 1115508, 1115529, 1115540, 1115501 Cockshutt - #MAO-1096	

B5011-008	Delco Starter Switch Lever	\$8.99
	Cockshutt For use in "PUSH" rod starter switch systems. Replaces: #T7674, 1878153 (Delco) Fits: E3 (Co-Op with Buda Over Head Valve Engine), 30 GAS	

CUTOUT RELAYS & VOLTAGE REGULATORS

Note: Due to modern battery design, voltage regulators can't be used to charge low or dead batteries. Doing so will destroy the voltage regulator and void the warranty.

B8001-001	6-Volt Cutout Relay	\$19.50
	15 Amps, 6 Volt Works Positive or Negative Ground Replaces: Autolite - CB4014, C4012(9-5), C4012(9-4), C4012(9-1), R40061 Cockshutt - #TO7614 Delco - #266P, 266N, 265P, 265N, 5015850, 812970, 265J, 820845, 812971, 1116816, 265G, 265H, 1116755, 1116751, 1116809DR, 265B, 1842859, 265C, 1867781, 265F, 265D Fits: Cockshutt (CO-OP) - Cockshutt: 30(up to SN: 31195), 40(up to SN: 6785) With Generator #GED-4818-A (Co-Op): E3, E4	

B8001-002	Electronic Cutout Relay	\$19.50
	25 Amp, Works with 6, 12, or 24 Volts. & Positive or Negative Ground Replaces: Autolite - #CB4014, C4012(9-5), C4012(9-4), C4012(9-1), R40061 Cockshutt - #TO7614 Delco - #266P, 266N, 265P, 265N, 5015850, 812970, 265J, 820845, 812971, 1116816, 265G, 265H, 1116755, 1116751, 1116809DR, 265B, 1842859, 265C, 1867781, 265F, 265D Fits: Cockshutt (CO-OP) - Cockshutt: 30(up to SN: 31195), 40(up to SN: 6785) With Generator #GED-4818-A (Co-Op): E3, E4	

12-Volt Delco Type Voltage Regulator		
B8002-015	Premium Quality, USA Made	\$108.50
B8002-016	Standard Quality	\$34.75
	12 Volt, 4 Terminals, Curved Mounting Bracket/ Generator Mounted, Positive or Negative Ground Replaces: Delco - #1118266, 1118306, 1118791, 1118983, 1118985, D644, D648 Briggs & Stratton Engines - #296028 Case - #A21533, G44855 Fits: Cockshutt (CO-OP) - Model 540 [Models 30, 40, 50, 550, 570] with Generators #GHD-6001-F, GHD-6001-K, GHD-6001-Q, GHD-6001X, GHD-6001Y, GHH600B, GHH-600F, GHH-6001B, GHH-6001E [Models 550, 570] with Generators #1100350, 1100396	

Delco Type Voltage Regulator		
B8002-019	Premium Quality, Made in the USA	\$116.51
B8002-020	Standard Quality	\$34.75
	12 Volt, Generator Mounted Delco Voltage Regulator Fits: Cockshutt (CO-OP) - 550, 570, Super 570 (With Generators #1100352, 1100397) Replaces: Delco - #1118792, 1118991, D649 Prestolite - #8-295, GRX-408	

BRUSH SETS

X324	Brush Set	\$8.25
	Cockshutt (CO-OP) Fits: 20, [30, 40, 50, 550, 570 With Generator #GHD-6001-F, GHD-6001-K, GHD-6001-Q, GHD-6001X, GHD-6001Y, GHH600B, GHH-600F, GHH-6001B, GHH-6001E], 540	

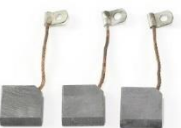
X349	Brush Set	\$7.75
	Cockshutt (CO-OP) Fits: 540, [550, 570 With Generator #1100350, 1100396], [550, 570, 570 Supers With Generator #1100352, 1100397]	

IDENTIFICATION TAGS

B9013-001	Small Autolite I.D. Tag (Blank)	\$7.00
	Small Autolite I.D. Tag (Stamped)	\$14.25
	2 5/16" Long, Black I.D. Tag for Distributors, Starters, & Generators with Rivets	

B9013-002	Large Autolite I.D. Tag (Blank)	\$7.00
	Large Autolite I.D. Tag (Stamped)	\$14.25
		2 15/16" Long, Black I.D. Tag for Distributors, Starters, & Generators with Rivets

Delco Remy

B9013-003	Large Delco Remy I.D. Tag (Blank)	\$9.00
	Large Delco Remy I.D. Tag (Stamped)	\$16.25
		Large Black Delco-Remy I.D. Tag for Distributors, 6 Volt Starters, & 6 Volt Generators with Rivets, 1 1/4" X 2 7/8"

B9013-004	Delco Remy I.D. Tag (Blank)	\$7.00
	Delco Remy I.D. Tag (Stamped)	\$14.25
		Black Delco-Remy I.D. Tag for Distributors, 6 Volt Starters, & 6 Volt Generators with Rivets, 3/4" 2 5/16"

B9013-005	Red Delco Remy I.D. Tag (Blank)	\$7.00
	Red Delco Remy I.D. Tag (Stamped)	\$14.25
		Red Delco-Remy I.D. Tag for 12 Volt Starters & 12 Volt Generators with Rivets, 3/4" 2 5/16"

B9013-013	Delco Remy I.D. Tag (Blank)	\$7.00
	Delco Remy I.D. Tag (Stamped)	\$14.25
		Black Delco-Remy I.D. Tag for Distributors, 6 Volt Starters, & 6 Volt Generators with Rivets, 3/4" 2 5/16"

ALTERNATORS

B6001-001	12 Volt Alternator (1 Wire)	\$112.75
63 Amp, Low Cut In, Specially Built For Tractors, Forklifts, & Other Low Engine Speed Applications		



B6001-005	6 Volt Alternator (1 Wire, Positive Ground)	\$166.50
6 Volt, 40 Amp Alternator with Positive Ground, 1 Wire, 3/8" pulley		

Small ND Type

B6002-003	12 Volt Small Denso Alternator (1-Wire)	\$119.75
		40 Amp, 1 Wire Internal Regulator. Will Start Charging with a Much Lower Engine Speed. Comes with a 4 1/2" Housing Diameter, 3/8 To 1/2" Belt width & a 2 1/2" Pulley Diameter. Excellent for Converting a 6 Volt System to 12 Volt. Negative Ground Only & is Self-Excited

LIGHTS & LIGHT PARTS

B9016-003	Flat Lens Type Head Lamp	\$99.99
		6 Volt Head, & clear rear lamp (can be used as 12 volt by Changing bulb) Cockshutt Replaces: #B7379D Fits: Oliver Built Cockshutt Tractor: 60, 70, 80, 90, 99

PARTS FOR LIGHT ABOVE

Interchangeable with original except as noted.

B9017-002	7" Lens With Guide Name	\$21.99
B9017-003	7" Clamp Ring	\$17.99
B9017-005	7" Gasket	\$8.99
B9017-006	7" Reflector *Call for Availability*	\$16.50
B9017-067	7" Light Terminal	\$6.00
B9017-013	6 Volt Bulb	\$3.00
	Fits Above Reflector, Not Original	
	Pack of 10	\$25.50
B9017-015	12 Volt Bulb	\$3.00
	Fits Above Reflector, Not Original	
	Pack of 10	\$25.50

Headlight Assembly Cockshutt

B9016-040	Bullet Type 6 Volt Head	\$53.99
B9016-041	Bullet Type 12 Volt Head	\$53.99
		Cockshutt Fits: 20, 30, 40, 50, 540, 560, 570

PARTS FOR LIGHT ABOVE

B9017-056	4 3/4" Lens with Guide Name	\$14.99
B9017-057	4 3/4" Clamp Ring (Black)	\$15.99
B9017-058	4 3/4" Gasket	\$3.99
B9017-004	4 3/4" Reflector	\$14.99
B9017-067	4 3/4" Light Terminal	\$6.00
B9017-013	6 Volt Bulb	\$3.00
	Pack of 10	\$25.50
B9017-015	12 Volt Bulb	\$3.00
	Pack of 10	\$25.50

B9016-004	12 Volt Sealed Beam Head Light	\$49.99
	Cockshutt Replaces: #T020776, T020777 Fits: 540 (Serial #AP1001 & Up), 560 (Serial #C07001 & Up), 570 (Serial #D07001 & Up)	

B9016-006	Bullet Type Head Lamp	\$57.99
	6 Volt Head, & Clear Rear Lamp (can be used as 12 volt by changing bulb) Cockshutt Replaces: #7017075, TO17074 Fits: 550, 560, 570	

B9017-112	12-Volt LED Lamp, Flood Beam Pattern	\$53.99
	5.730" diameter, Polarity sensitive, negative ground only, 6 LED bulbs 1400 Lumens, 18 Watts, Die cast aluminum housing, Scratch resistant lens, 50,000 hour rated, IP67 waterproof rating, 6000K color temperature, Excellent work light illuminates wide/ short areas.	

PARTS FOR LIGHT ABOVE		
B9017-056	4 3/4" Lens with Guide Name	\$14.99
B9017-057	4 3/4" Clamp Ring (Black)	\$15.99
B9017-058	4 3/4" Gasket	\$3.99
B9017-004	4 3/4" Reflector	\$14.99
B9017-067	4 3/4" Light Terminal	\$6.00
B9017-013	6 Volt Bulb	\$3.00
	Pack of 10	\$25.50
B9017-015	12 Volt Bulb	\$3.00
	Pack of 10	\$25.50

Bullet Type Work/ Tail Light with Switch		
B9016-021	6 Volt (B9016-083 for Black*)	\$79.99
B9016-018	12 Volt (B9016-084 for Black*)	\$79.99
	(*Black versions sold for lower prices) Combo/Red Dot Tail Lamp Cockshutt Replaces: #TO13153 Fits: 20, 30, 35, 35 Blackhawk, 40, 40 Blackhawk, 40D4 Golden Eagle, 40PD Golden Eagle, 50, 50 Blackhawk, Co- Op with Continental F124: E2, Co-Op with Buda Over Head Valve Engine: E3, E4, E5	

B9016-062	12V Headlight Assembly	\$49.99
	12 Volt 5 3/4" Headlight. Stamped: TRACT-O-LITE on housing. Cockshutt Replaces: #TO20776, TO20777 Fits (SN: AP1001 & up): 540 (SN: 7001 & up) - 550, 560, 570	

PARTS FOR LIGHT ABOVE		
B9017-056	4 3/4" Lens with Guide Name	\$14.99
B9017-059	4 3/4" Clamp Ring (Red)	\$15.99
B9017-058	4 3/4" Gasket	\$3.99
B9017-007	4 3/4" Reflector	\$21.99
B9017-067	4 3/4" Light Terminal	\$6.00
B9017-010	Light Switch Assembly	\$18.50
B9017-013	6 Volt Bulb	\$3.00
	Pack of 10	\$25.50
B9017-015	12 Volt Bulb	\$3.00
	Pack of 10	\$25.50
B9017-037	6 Volt Miniature Bulb	\$1.25
B9017-039	12 Volt Miniature Bulb	\$1.25
B9017-066	Red Dot Jewel Lens Assembly	\$17.99
B9017-077	Rear Combo Light Switch with Knob (3 Screw Terminals)	\$18.50

B9016-063	6V Headlight Assembly	\$52.99
	6 Volt 5 3/4" Headlight. Stamped: TRACT-O-LITE on housing. Cockshutt Replaces: #TO19437, TO19438 Fits: 540 (up to SN AP1000)	

Bullet Type Combo/Red Dot Tail Lamp with Switch		
B9016-032	6 Volt	\$79.99
B9016-033	12 Volt	\$83.99
	Mounts On Back Of Seat Cockshutt Fits: Cockshutt: 550, 560, 570, Replaces: #TO18681	

PARTS FOR LIGHTS ABOVE		
B9017-033	Sealed Beam, 12 Volt Bulb	\$14.75
B9017-034	Sealed Beam, 6 Volt Bulb	\$19.75
	Double Contact High Beam 35 Watts with a 5.625" Outside Diameter	

PARTS FOR LIGHT ABOVE		
B9017-056	4 3/4" Lens with Guide Name	\$14.99
B9017-057	4 3/4" Clamp Ring (Black)	\$15.99
B9017-058	4 3/4" Gasket	\$3.99

B9017-007	4 3/4" Reflector	\$21.99
B9017-067	4 3/4" Light Terminal	\$6.00
B9017-010	Light Switch Assembly	\$18.50
B9017-013	6 Volt Bulb	\$3.00
	Pack of 10	\$25.50
B9017-015	12 Volt Bulb	\$3.00
	Pack of 10	\$25.50
B9017-037	6 Volt Miniature Bulb	\$1.25
B9017-039	12 Volt Miniature Bulb	\$1.25
B9017-066	Red Dot Jewel Lens Assembly	\$17.99
B9017-097	12-Volt LED Lamp, Trapezoid Beam Pattern	\$49.99



Cockshutt
Replaces: #103463A
Fits: 770, 880, 1350, 1550, 1555, 1600, 1650, 1655, 1750, 1755, 1800, 1800B, 1850, 1855, 1900, 1950, 1950T, 1955, 2050, 2150

B9017-098	12-Volt LED Lamp, Flood Beam Pattern	\$49.99
------------------	---	----------------



Cockshutt
Replaces: #105774A, 30-3169898
GE: #4410, 4411
Fits (Oliver-built): 1350, 1550, 1555, 1600, 1650, 1655, 1750, 1755, 1800, 1850, 1855, 1900, 1950, 1950T, 1955, 2050, 2150

B9016-054	Round Fender & Cab Mount Warning Light	\$19.99
------------------	---	----------------



Restoration Quality 12 Volt Round Light with 2 x 4" Diameter Amber Lenses, Double Contact Bulb, 1/2" Diameter Stud, & 2.4" Thick at Widest Point.
Cockshutt
Fits: Various Models

B9016-055	Rectangular Fender & Cab Mount Warning Light	\$32.99
------------------	---	----------------



Restoration Quality 12 Volt Rectangular Light
One Red and One Amber Lens With Amber Side Marker
4.5" Wide & 1/2" Diameter Stud
Cockshutt
Fits: Various Models

DASH LAMPS

B9016-013	Chrome Finish Dash Lamp	\$19.75
------------------	--------------------------------	----------------



6 or 12 Volt, Chrome Finished Dash Lamp.
Bulb not included.
6 Volt Use Bulb #B9017-046
12 Volt Use Bulb #B9017-049
Fits: **Cockshutt** - Various Models

B9016-014	Black Finish Dash Lamp	\$19.75
------------------	-------------------------------	----------------



6 or 12 Volt, Black Finished Dash Lamp.
Bulb not included.
6 Volt Use Bulb #B9017-046
12 Volt Use Bulb #B9017-049
Fits: **Cockshutt** - Various Models

Light Bulbs

B9017-046	6 Volt Bulb	\$1.25
------------------	--------------------	---------------

B9017-049	12 Volt Bulb	\$1.25
------------------	---------------------	---------------



Light bulbs for product #B9016-013, B9016-014

B9017-036	6-Volt Sealed Beam Bulb	\$14.50
------------------	--------------------------------	----------------



30-Watt, Double Contact, 4.5" Diameter, Low Beam
Cockshutt
Replaces: GE #4511
Fits: 20, 30, 35, 40, 50, 540, 550, 560, 570, 1350, 40D4 Golden Eagle, Golden Arrow

AUXILIARY PLUGS & SOCKETS

B9032-001	2 Pole Auxiliary Plug	\$23.75
------------------	------------------------------	----------------



Fits:
Cockshutt - Various Models

B9032-002	2 Pole Auxiliary Connector	\$19.75
------------------	-----------------------------------	----------------



(Used With B9032-001)
Fits:
Cockshutt - Various Models

CIGARETTE LIGHTERS

B9030-001	6 Volt Cigarette Lighter	\$29.99
------------------	---------------------------------	----------------





Anodized Aluminum
Knob Engraved with the word Lighter
Cockshutt
Replaces: #T17847, T17845, TO16480
Fits: Cockshutt: 35 Golden Arrow (W/ 6 Volt System)

B9030-002	12 Volt Cigarette Lighter	\$29.99
------------------	----------------------------------	----------------



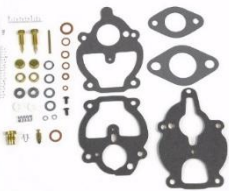

Anodized Aluminum
Knob Engraved with the word Lighter
Cockshutt
Replaces: #T17846, TO16481, T17847, 31-1647093
Fits: 40, 50 (Diesel), 550, 560, 570, [Co-Op: E4, E5 (Diesel)]

CARBURETOR REBUILD KITS

B9022-008	Zenith Carburetor Rebuild Kit	\$26.95
	<p>Cockshutt (Co-Op) Tractors Model E-3, 30, 540 Fits Carburetor: Zenith Carburetor: #12262, 12522, 12544, 12566, 12773 Cockshutt Carburetor: #3122953, TO-7715, TO-19146B</p>	
B9022-023	Marvel-Schebler Carburetor Rebuild Kit	\$24.50
	<p>Cockshutt (Co-Op) Tractor Model E-2, E-3, 20, 20 Deluxe, 30, 35, 60 (Oliver Built) Fits Carburetor: Marvel-Schebler Carburetor: #1004SL, TSX101, TSX102, TSX103, TSX112, TSX113, TSX114, TSX119, TSX120, TSX126, TSX128, TSX13, TSX132, TSX132A, TSX133, TSX134, TSX136, TSX137, TSX138, TSX140, TSX141, TSX142, TSX144, TSX146, TSX147, TSX148, TSX150, TSX151, TSX154, TSX155, TSX156, TSX157, TSX159, TSX161, TSX167, TSX171, TSX173, TSX179, TSX180, TSX182, TSX183, TSX184, TSX186, TSX188, TSX189, TSX190, TSX191, TSX192, TSX193, TSX194, TSX197, TSX198, TSX202, TSX203, TSX206, TSX206-1, TSX211, TSX212, TSX225, TSX228, TSX231, TSX237, TSX239, TSX239-1, TSX240, TSX241A, TSX241B, TSX241C, TSX246, TSX248, TSX253, TSX254, TSX258, TSX260, TSX264, TSX266, TSX267, TSX269, TSX272, TSX274, TSX278, TSX28, TSX280, TSX286, TSX287, TSX288, TSX289, TSX29, TSX290, TSX297, TSX30, TSX301, TSX305, TSX306, TSX308, TSX309, TSX312, TSX314, TSX315, TSX319, TSX322, TSX323, TSX326, TSX328, TSX33, TSX330, TSX331, TSX332, TSX333, TSX334, TSX335, TSX338, TSX339, TSX34, TSX341, TSX346, TSX347, TSX348, TSX348, TSX35, TSX351, TSX352, TSX356, TSX357, TSX358, TSX359, TSX36, TSX361, TSX361-A, TSX363, TSX366, TSX367, TSX368, TSX37, TSX370, TSX370-1, TSX377, TSX38, TSX380, TSX388, TSX389, TSX39, TSX391, TSX398, TSX400, TSX403, TSX405, TSX406, TSX407, TSX409, TSX418, TSX419, TSX42, TSX420, TSX421, TSX422, TSX423, TSX428, TSX43, TSX44, TSX443, TSX447, TSX448, TSX45, TSX450, TSX452, TSX453, TSX455, TSX458, TSX459, TSX465, TSX470, TSX472, TSX474, TSX48, TSX480, TSX481, TSX484, TSX486, TSX49, TSX497, TSX500, TSX507, TSX510, TSX513, TSX514, TSX516, TSX518, TSX520, TSX525, TSX531, TSX532, TSX534, TSX539, TSX54, TSX541, TSX55, TSX551, TSX552, TSX556, TSX558, TSX560, TSX567, TSX569, TSX570, TSX573, TSX577, TSX58, TSX580, TSX589, TSX59, TSX593, TSX595, TSX597, TSX60, TSX603, TSX605, TSX606, TSX611, TSX614, TSX618, TSX626, TSX633, TSX635, TSX643, TSX646, TSX649, TSX649-1, TSX650, TSX653, TSX655, TSX656, TSX660, TSX663, TSX665, TSX668, TSX670, TSX671, TSX676, TSX680, TSX681, TSX683, TSX69, TSX690, TSX691, TSX692, TSX694, TSX696, TSX701, TSX706, TSX709, TSX710, TSX714, TSX730, TSX736, TSX74, TSX742, TSX744, TSX748, TSX753, TSX76, TSX762, TSX765, TSX767, TSX770, TSX771, TSX776, TSX776-1, TSX78, TSX781, TSX787, TSX79, TSX793, TSX796, TSX80, TSX802, TSX803, TSX804, TSX809, TSX812, TSX815, TSX820, TSX826, TSX827, TSX83, TSX830, TSX841, TSX844, TSX85, TSX851, TSX855, TSX857, TSX860, TSX862, TSX864, TSX865, TSX866, TSX879, TSX88, TSX882, TSX89, TSX896, TSX896SL, TSX90, TSX901, TSX91, TSX912, TSX913, TSX914, TSX919, TSX926, TSX930, TSX931, TSX936, TSX936SL, TSX937, TSX937SL, TSX94, TSX948, TSX949, TSX95, TSX954, TSX957, TSX957SL, TSX95A, TSX96, TSX971, TSX976, TSX978, TSX979, TSX979-1, TSX98, TSX983, TSX986, TSX987, TSX99, TSX990, TSX991, TSX991-1, TSX996, TSXU828, TSXU829, TSXU830, TSXU831, TSXU832, TSXU833, TSXU834, 1003 Cockshutt (Co-Op) Carburetor: #T012049, T012049B, T013124, T07013, MXR-3014</p>	

B9022-009	Zenith Carburetor Rebuild Kit	\$27.99
	<p>Cockshutt (Co-Op) Tractors Model 40, 50 Fits Carburetor: Zenith Carburetor #10946, 10946A, 11489, 11489A, 11509, 11622, 11644, 14644 Cockshutt Carburetor: #TG-07013B, TO-13162, TO-13354</p>	

B9022-011	Zenith Carburetor Rebuild Kit	\$24.99
	<p>Cockshutt (Co-Op) Tractors Model 35, 550, GO-198 Fits Carburetor: Zenith Carburetor #11973, 11973A, 11973B, 12032, 12032A, 12032B, 12032C Cockshutt Carburetor #TO-16383, TO-17042</p>	

B9022-005	Marvel-Schebler Carburetor Rebuild Kit	\$23.99
	<p>Cockshutt Tractors Model 550 (Oliver Built Only) Fits Carburetor: Marvel-Schebler Carburetor: TSX1001, TSX1002, TSX181, TSX221, TSX245, TSX296, TSX332, TSX360, TSX374, TSX397, TSX413, TSX414, TSX436, TSX464, TSX466, TSX475, TSX492, TSX505, TSX506, TSX506A, TSX526, TSX528, TSX530, TSX561, TSX562, TSX563, TSX575, TSX582, TSX592, TSX596, TSX602, TSX605, TSX606, TSX610, TSX615, TSX633, TSX639, TSX641, TSX645, TSX648, TSX662, TSX678, TSX688, TSX689, TSX695, TSX704, TSX711, TSX713, TSX719, TSX721, TSX725, TSX732, TSX737, TSX738, TSX755, TSX756, TSX757, TSX759, TSX768, TSX769, TSX772, TSX773, TSX775, TSX777, TSX784, TSX788, TSX791, TSX792, TSX797, TSX798, TSX799, TSX800, TSX801, TSX806, TSX808, TSX810, TSX811, TSX813, TSX814, TSX816, TSX819, TSX825, TSX836, TSX843, TSX849, TSX853, TSX854, TSX856, TSX857, TSX867, TSX869, TSX871, TSX877, TSX878, TSX881, TSX883, TSX884, TSX885, TSX886, TSX888, TSX889, TSX892, TSX892S, TSX893, TSX894, TSX895, TSX897, TSX898, TSX899, TSX900, TSX902, TSX903, TSX904, TSX904SL, TSX905, TSX905-1, TSX905SL, TSX906, TSX906SL, TSX907, TSX907SL, TSX908, TSX908SL, TSX911, TSX917, TSX920, TSX920SL, TSX921SL, TSX922, TSX922SL, TSX923, TSX923SL, TSX925, TSX927, TSX928, TSX932, TSX932SL, TSX933, TSX934, TSX934SL, TSX938, TSX938SL, TSX939, TSX940, TSX940SL, TSX941, TSX941SL, TSX942, TSX943, TSX944SL, TSX945SL, TSX946, TSX947SL, TSX949, TSX950, TSX952, TSX952SL, TSX955, TSX959, TSX959SL, TSX961, TSX961SL, TSX962, TSX962SL, TSX964SL, TSX965SL, TSX966, TSX967SL, TSX968SL, TSX97, TSX972, TSX973, TSX974, TSX974SL, TSX975, TSX975SL, TSX977, TSX980, TSX980SL, TSX984SL, TSX985, TSX985SL, TSX988, TSX989, TSX993, TSX994, TSX997, TSX998, TSX999, TSXU1006, TSXU1007, TSXU835, TSXU836, TSXU840, TSXU904, TSXU904SL, TSXU905, TSXU905-1, TSXU944SL, TSXU963, TSXU9631, TSXU995</p>	

CARBURETOR FLOATS

B9023-003	Marvel-Schebler Carburetor Float	\$12.75
	<p>Cockshutt (Co-Op) Tractors Model 20, 30, 35 Marvel-Schebler Carburetor: #TSX-264, TSX-480, TSX-520, TSX-531, TSX-611, TSXU-831, TSXU-832 Cockshutt Carburetor: #MXR-3014, TO-7013, TO-12049, TO-12049-B, TO-13124 Replaces: Cockshutt(Co-Op): #TO7074</p>	

B9023-011	Zenith Carburetor Float	\$34.50
	<p>Cockshutt (Co-Op) Tractors Model 40, 50 Zenith Carburetor: #10946, 10946A, 11489, 11489A, 11509, 11622, 11644, 14644 Cockshutt Carburetor: #TG-07013B, TO-13162, TO-13354 Replaces: Cockshutt(Co-Op): #T16566 Zenith: #C85-115</p>	

B9023-015	Zenith Carburetor Float	\$24.99
	<p>Cockshutt (Co-Op) Tractors Model 35, 550, 570 Replaces: Cockshutt: T16566. Zenith: #C85-115, C85-115S Fits Carburetor: (various- see www.brillman.com)</p>	

CARBURETOR ACCESSORIES

B9038-003	Carburetor Elbow Fuel Line Fitting with Strainer	\$7.99
	<p>Elbow Fuel Line Fitting with strainer for IHC carburetors. 1/8" Pipe to 1/4" Flare. Works with Carter UT Series and Various Marvel-Schebler Carburetors. Fits: Cockshutt - 20, 30, 35, 40, 50, 540, 550, 560, 570, 1350, 40D4, Golden Eagle, Golden Arrow</p>	

B9038-007	2" Sediment Bowl Gasket	\$2.19
	<p>2" Outer Diameter, Bowl to Body; Fits a 1.28" Tall Glass Bowl Cockshutt Replaces: 12081G Fits (when shorter 1.280" sediment bowl is used): E2, E3, 20, 30, 540</p>	

FUEL SEDIMENT BOWLS

B9036-001	Fuel Sediment Bowl	\$27.99
	<p>Has a 3/8" Pipe Inlet and a 1/8" Pipe Outlet. Bowl is 1.280" Long. Shallow Bowl has 90° Outlet Only. Cockshutt (Co-Op) Fits: Co-Op : E3 (when shorter 1.280 tall glass sediment bowl is desired.), Co-Op: E2 (when shorter 1.280 tall glass sediment bowl is desired.), [Cockshutt: 20, 540 (when shorter 1.280 tall glass sediment bowl is desired.)], 30 (Gas, when shorter 1.280 tall glass sediment bowl is desired.)</p>	

B9036-002	Fuel Sediment Bowl	\$34.99
	<p>Has a 3/8" Pipe Inlet, 1/8" Pipe Outlet, and a 2.315" tall glass bowl Cockshutt Replaces: T01718 Fits: [E2, E3, E4, E5, 20, 30, 40, 50, 540, 550, 570, 35 BLACKHAWK Gas, Using 2.315 Long Glass Bowl]</p>	

Parts for Sediment Bowl Above

B9038-024	Connector w/ Female Fitting	\$8.99
B9038-008	2" Sediment Bowl Screen	\$3.99
B9038-012	Sediment Bowl Gasket	\$2.99

FUEL SYSTEM ACCESSORIES

B9038-009	Fuel Cap	\$10.99
	<p>Chrome Plated, 2.7" Outside Diameter, 1.88" Overall Tab Length, .25" Tab Width Cockshutt Replaces: T14804, T19925 Fits: 20, 30, 35, 40, 50, 540, 550, 560, 570, 35 Blackhawk, 40 Blackhawk, 40D4 Golden Eagle, E2, E3, E4, E5</p>	

CONTINENTAL ENGINES

TABLE OF CONTENTS

Spark Plug Wire Sets _____	118
Distributors _____	119
Tune Up Parts _____	121

SPARK PLUG WIRE SETS

Our Spark Plug Wire Sets Come Fully Assembled with the Proper Type Wire & Terminals.

They are Custom Tailored to Look & Fit Like Original Factory Equipment.

Varieties include:

Cotton Braid Wire: Copper Core with a Cotton Jacket.

PVC Wire: Copper Core with a Rubber Jacket.

EPDM Wire (E): Hi Performance Premium Conductor with a Tinned Copper Core, EPDM Silicone Insulation, and a Rubber Jacket.

Suppression Wire (S): for Electronic Ignition and is Spiral Wound, Ultra Low-Ohm, with EPDM Silicone Insulation and a Rubber Jacket.

Cotton Braid Suppression Wire (CS): also for Electronic Ignition, as Suppression Wire, but has an additional layer of Cotton Braid & Lacquer to replicate the vintage look, as well.



Continental C16

6 Cyl. Tailored Spark Plug Wire Set

B1013-021	Original Type Cotton Braid Wire	\$51.00
B1013-021E	EPDM Wire	\$55.75

Continental E201

4 Cyl. Tailored Spark Plug Wire Set

B1013-010	Original Type Cotton Braid Wire	\$23.75
B1013-010E	EPDM Wire	\$26.00

Continental E223

4 Cyl. Tailored Spark Plug Wire Set

B1013-023	Original Type PVC Wire	\$20.00
B1013-023E	EPDM Wire	\$24.00

Continental E208

4 Cyl. Tailored Spark Plug Wire Set

B1013-011	Original Type PVC Wire	\$21.50
B1013-011E	EPDM Wire	\$26.00

Continental F124

4 Cyl. Tailored Spark Plug Wire Set

B1013-004	Original Type Cotton Braid Wire	\$23.75
B1013-004E	EPDM Wire	\$26.00
B1013-004S	Suppression Wire	\$26.00

Continental F140

4 Cyl. Tailored Spark Plug Wire Set

B1013-006	Original Type Cotton Braid Wire	\$22.75
B1013-006E	EPDM Wire	\$24.50
B1013-006S	Suppression Wire	\$24.50

Continental F162 with Distributor on Top of Motor

4 Cyl. Tailored Spark Plug Wire Set

B1013-007	Original Type Cotton Braid Wire	\$23.75
B1013-007E	EPDM Wire	\$26.00
B1013-007S	Suppression Wire	\$26.00

Continental F163 with Distributor

4 Cyl. Tailored Spark Plug Wire Set

B1013-008	Original Type PVC Wire	\$21.50
B1013-008E	EPDM Wire	\$26.00
B1013-008S	Suppression Wire	\$26.00

Continental F162/ F163 with Magneto

4 Cyl. Tailored Spark Plug Wire Set

B1013-029	Original Type EPDM Wire	\$30.25
------------------	--------------------------------	----------------

Continental F209

6 Cyl. Tailored Spark Plug Wire Set

B1013-012	Original Type Cotton Braid Wire	\$33.50
B1013-012E	EPDM Wire	\$36.50

Continental F218

6 Cyl. Tailored Spark Plug Wire Set

B1013-013	Original Type Cotton Braid Wire	\$33.50
B1013-013E	EPDM Wire	\$36.50

Continental F226

6 Cyl. Tailored Spark Plug Wire Set

with Distributor on Top of Motor

B1013-014	Original Type Cotton Braid Wire	\$33.50
B1013-014E	EPDM Wire	\$36.50
B1013-014S	Suppression Wire	\$36.50

with Magneto on Side of Motor

B1013-033	Original Type EPDM Wire	\$54.50
------------------	--------------------------------	----------------

Continental F227 with Distributor on Top of Motor

6 Cyl. Tailored Spark Plug Wire Set

B1013-034S	Suppression Wire	\$43.50
-------------------	-------------------------	----------------

Continental F244

6 Cyl. Tailored Spark Plug Wire Set

B1013-015	Original Type Cotton Braid Wire	\$33.50
B1013-015E	EPDM Wire	\$36.50

Continental F245

6 Cyl. Tailored Spark Plug Wire Set

B1013-016	Original Type Cotton Braid Wire	\$33.50
B1013-016E	EPDM Wire	\$36.50
B1013-016S	Suppression Wire	\$36.50

Continental G176

4 Cyl. Tailored Spark Plug Wire Set

B1013-024	Original Type PVC Wire	\$20.00
B1013-024E	EPDM Wire	\$24.00

Continental H260

4 Cyl. Tailored Spark Plug Wire Set

B1013-017	Original Type Cotton Braid Wire	\$23.75
B1013-017E	EPDM Wire	\$26.00

Continental H277

4 Cyl. Tailored Spark Plug Wire Set

B1013-018	Original Type PVC Wire	\$21.50
B1013-018E	EPDM Wire	\$26.00

Continental J382

4 Cyl. Tailored Spark Plug Wire Set

B1013-019	Original Type Cotton Braid Wire	\$22.75
B1013-019E	EPDM Wire	\$24.50

Continental M290, M330

6 Cyl. Tailored Spark Plug Wire Set

B1013-025	Original Type Cotton Braid Wire	\$35.75
B1013-025E	EPDM Wire	\$39.25

Continental N62

4 Cyl. Tailored Spark Plug Wire Set

B1013-001	Original Type Cotton Braid Wire	\$25.25
B1013-001E	EPDM Wire	\$27.25

Continental TA427

6 Cyl. Tailored Spark Plug Wire Set

B1013-027	Original Type Cotton Braid Wire	\$39.00
B1013-027E	EPDM Wire	\$42.50

Continental TM20

3 Cyl. Tailored Spark Plug Wire Set
with Points Ignition

B1013-020	Original Type EPDM Wire	\$22.75
------------------	--------------------------------	----------------

with Electronic Ignition/ Distributor

B1013-030	Original Type Suppression Wire	\$22.75
------------------	---------------------------------------	----------------

Continental TM27

4 Cyl. Tailored Spark Plug Wire Set
with Points Ignition

B1013-031	Original Type PVC Wire	\$21.50
B1013-031E	EPDM Wire	\$26.00

with Perlux Electronic Distributor

B1013-032	Original Type Suppression Wire	\$26.00
------------------	---------------------------------------	----------------

Continental Y69

4 Cyl. Tailored Spark Plug Wire Set

B1013-022	Original Type Cotton Braid Wire	\$23.75
B1013-022E	EPDM Wire	\$26.00

Continental Y91 & Y112

4 Cyl. Tailored Spark Plug Wire Set

B1013-002	Original Type Cotton Braid Wire	\$23.75
B1013-002E	EPDM Wire	\$26.00
B1013-002S	Suppression Wire	\$26.00

Continental Z120

4 Cyl. Tailored Spark Plug Wire Set

B1013-003	Original Type PVC Wire	\$20.50
B1013-003E	EPDM Wire	\$24.50

Continental Z134 & Z145

4 Cyl. Tailored Spark Plug Wire Set

B1013-005	Original Type PVC Wire	\$20.50
B1013-005E	EPDM Wire	\$24.50
B1013-005S	Suppression Wire	\$24.50

Continental Z172

4 Cyl. Tailored Spark Plug Wire Set

B1013-009	Original Type PVC Wire	\$20.50
B1013-009E	EPDM Wire	\$24.50

DISTRIBUTORS

Continental Z120, Z129, Z134

181685M91	Delco Remy Distributor	\$129.75
 <p>4 Cyl. Complete New Replacement Distributor Replaces: Massey Ferguson - #181685M91, 182852M91, 181544M91, 181686M91 Delco - #1111722, 1111740, 1112557, 1112570</p>		

B9500-005	2-Cylinder Pertronix Distributor	\$370.95
 <p>12-Volt, Negative Ground Continental Replaces: TM13M-00501 Note: Must use Suppression Spark Plug Wire. Use of any other type of Wire will Void the Warranty.</p>		

PARTS FOR DISTRIBUTOR ABOVE

	B9504-003	\$7.45
Rotor Kit		
	B9505-001	\$6.45
Dust Cover		
	B9506-001	\$97.95
Module		
Includes Additional Mounting Parts		
	B9509-002	\$31.45
Gear Kit		

B9500-007	4-Cylinder Pertronix Distributor	\$279.95
	12-Volt, Negative Ground Continental Fits: 1940-65 (F124, F140, F162, F4124, F4140, F4162, FA140, FA162), 1965-present (F135, F163), 1965-present (Y69, Y91, Y112, Y4069, Y4091, Y4112, YA112, IY112) Note: Must use Suppression Spark Plug Wire. Use of any other type of Wire will Void the Warranty.	
B9500-019	4-Cylinder Pertronix Distributor	\$495.50
(As B9500-007 above, except that it's custom made to fit Delco #1110423)		

PARTS FOR DISTRIBUTOR ABOVE

	B9503-001	\$18.45
Cap Kit Includes Gasket		
	B9504-002	\$8.45
Rotor Kit Includes Gasket		
	B9505-001	\$6.45
Dust Cover		
	B9506-002 (Negative Ground)	\$97.95
	B9506-004 (Positive Ground)	\$119.50
Module, 12-volt, 4-cylinder Includes Additional Mounting Parts		
	B9508-001	\$3.95
Cap Gasket		
	B9509-001	\$46.45
Industrial Drive Kit		

B9500-014	4-Cylinder Pertronix Distributor	\$ 324.45
	12-Volt, Negative Ground Continental Replaces: TM27M-00502, TM27M-00503, TM27M-00510 Prestolite: IDN-4012 Fits: TM-27 engine models (All) Note: Must use Suppression Spark Plug Wire.	

PARTS FOR DISTRIBUTOR ABOVE

	B9503-004	\$18.45
Cap Kit Includes Gasket		

	B9504-003	\$7.45
Rotor Kit		
	B9505-001	\$6.45
Dust Cover		
	B9509-002	\$31.45
Gear Kit		

B9500-015	6-Cylinder Pertronix Distributor	\$279.95
	12-Volt, Negative Ground Continental Fits: 1940-65 F6 Series (F170, F186, F209, F218, F224, F226, F244, F6170, F6186, F6209, F6226, F6244), 1965-present F6 Series (F227, F245, F6227) Note: Must use Suppression Spark Plug Wire. Use of any other type of Wire will Void the Warranty.	

PARTS FOR DISTRIBUTOR ABOVE

	B9503-002	\$20.95
Cap Kit Includes Gasket		
	B9504-002	\$8.45
Rotor Kit Includes Gasket		
	B9505-001	\$6.45
Dust Cover		
	B9506-002 (Negative Ground)	\$97.95
	B9506-004 (Positive Ground)	\$119.50
Module, 12-volt, 4-cylinder Includes Additional Mounting Parts		
	B9508-001	\$3.95
Cap Gasket		
	B9509-001	\$46.45
Industrial Drive Kit		

B9500-020	3-Cylinder Pertronix Distributor	\$330.45
	12-Volt, Negative Ground Continental Replaces: TM20M-00503 Note: Must use Suppression Spark Plug Wire. Use of any other type of Wire will Void the Warranty.	

TUNE UP PARTS, Distributor

Continental F4 and Other Engines, Autolite/Prestolite Distributors #IBT-4501A, IBT-4701A, IBT-4701C		
	B4001-017	\$6.50
	Points Replaces: #IBP-2040L, IBP-3028BS, 1-33, 147V, 1-48	
	B4002-006	\$7.50
	Condenser Replaces: #2-31, 2-38, 2-42, 2-95, IAT-1125S, IAT-3076BS, IBB-2042SS-1, IBB-2042-SS3, IG-3927F, IG-3927G, IG-3927K, IG-3927R,	
	B4003-074	\$26.25
	Cap Replaces: #3-128, IBT1111	
	B4004-012	\$7.25
	Rotor Premium Grade, Made in the USA Replaces: #4-86, 4-93	

Continental 2 Cyl. TC56 with Autolite/Prestolite Distributor #IDR-4001		
	B4001-017	\$6.50
	Points Replaces: #IBP-2040L, IBP-3028BS, 1-33, 147V, 1-48	
	B4002-006	\$7.50
	Condenser Replaces: #2-31, 2-38, 2-42, 2-95, IAT-1125S, IAT-3076BS, IBB-2042SS-1, IBB-2042-SS3, IG-3927F, IG-3927G, IG-3927K, IG-3927R	
	B4003-005	\$18.25
	Distributor Cap (Note: Will Replace the Original 2-Cylinder Cap By Only Using 2 of the Cap Towers) Premium Grade, Made in the USA (Brass Contacts) Replaces: #IBT-1003B, IBT-1003C, 3-133, 3-123	
	B4004-040	\$6.25
	Rotor Premium Grade, Made in the USA Replaces: #IBT-1016C, 4-23	
	B4006-007	\$16.75
	Dust Cover Replaces: #31-267, IBT-1059B	

TUNE UP PARTS, Magneto

Continental with Fairbanks-Morse Magneto #FM-OR6B, FM-R6B, FM-XOR6A, FM-XOR6B, FM-XR6A, FM-XR6B, FM-Z6A, FM-Z6B		
	B4014-017	\$36.50
	Rotor Replaces: #Z2765	
	B4013-036	\$87.50
	Cap Replaces: #Q800 Includes Cap Brush	
with WICO Magneto #XH1909		
	B4011-004	\$17.75
	Points Replaces: #1-5008, 1-5111, FXH-2100B, FXH-2400B, X5996	
	B4012-002	\$13.75
	Condenser Replaces: #2-5007, X5614, X6916	
	B4013-014	\$55.75
	Cap Replaces: #3-5015	
	B4014-008	\$30.00
	Rotor Replaces: #4-5004	
	B4015-003	\$39.75
	Coil (Hot Coil) Replaces: #5-5011, AR12006, FXH2403, X5700, X5700B, X5700C	
	B4017-033	\$13.50
	Wico Impulse Trip Dog Set Repair Kit Replaces: #90-5033	

Table continues on next page.

CUSTOM

SPARK PLUG WIRE SETS

	B4017-007	\$12.50
	Impulse Spring Replaces: #94-5016	
	B4017-051	\$10.25
	WICO Impulse Catch Plate Replaces: #94-5070, FXH-210S-1	

Our Spark Plug Wire Sets Come **Fully Assembled with the Proper Type Wire & Terminals.**

They are Custom Tailored to Look & Fit Like Original Factory Equipment.

Varieties include:

Cotton Braid Wire: Copper Core with a Cotton Jacket.

EPDM Wire (E): Hi Performance Premium Conductor with a Tinned Copper Core, EPDM Silicone Insulation, and a Rubber Jacket.



Did You Know?

In August 1929, the Continental Motors Company formed the Continental Aircraft Engine Company as a subsidiary to develop and produce its aircraft engines

Custom Model B

6 Cyl. Tailored Spark Plug Wire Set

B1014-001	Original Type Cotton Braid Wire	\$35.75
B1014-001E	EPDM Wire	\$39.25

Custom Model C

6 Cyl. Tailored Spark Plug Wire Set

B1014-002	Original Type Cotton Braid Wire	\$35.75
B1014-002E	EPDM Wire	\$39.25

BATTERY CABLES



Our Battery Cables are made from the Proper Gauge Copper, as either **Black Cotton Braided Wire** or **PVC Wire** (whichever is correct for the application), using Soldered & Heat Sealed Brass or Copper Terminals.

Custom Model B

B2000-004	Positive Ground Strap	\$10.50
B2014-001	Negative Battery Cable	\$49.75
B2014-002	Switch To Starter Cable	\$37.50

Custom Model C

B2000-004	Positive Ground Strap	\$10.50
B2014-001	Negative Battery Cable	\$49.75
B2014-005	Switch To Starter Cable	\$37.50



WIRING HARNESSSES

Our Wire Harnesses are made with our **premium cotton braid and/or PVC wire**.

They have the **correct gauge, color, wire, & fuse holders** (if needed).

All terminals are **soldered according to the original**.

(Harnesses do not include Battery Cables & Spark Plug Wires; however, we can supply these as separate products.)

NO HIDDEN COSTS, NOTHING EXTRA TO BUY!

Custom B

B3014-001	Complete Wire Harness		\$145.50
------------------	------------------------------	--	-----------------

Custom C

B3014-002	Complete Wire Harness		\$145.50
------------------	------------------------------	--	-----------------

TUNE UP PARTS

Custom Model B, C

	B4001-005 Points Replaces: #1-4, 1-8, 1-9, 1-20, 1-22, 1-45, IAD-3128S, IGP-3028ES, IGP3028FS, IGS2224L, IGW3028AS	\$9.75
	B4002-006 Condenser Replaces: #2-31, 2-38, 2-42, 2-95, IAT-1125S, IAT-3076BS, IBB-2042SS-1, IBB-2042-SS3, IG-3927F, IG-3927G, IG-3927K, IG-3927R,	\$7.50
	B4004-007 Rotor Premium Grade, Made in the USA Replaces: #4-19	\$8.25
	B4003-007 Distributor Cap Premium Grade, Made in the USA (Brass Contacts) Replaces: #IGC-1107S, 3-23	\$25.00



For Ignition Coils & Accessories, see p.44

VOLTAGE REGULATORS

Note: Due to modern battery design, voltage regulators can't be used to charge low or dead batteries. Doing so will destroy the voltage regulator and void the warranty.



B8002-028	Autolite Type Voltage Regulator	\$158.60
	6 Volt, 3 Terminal, Flat Mounting Bracket Regulator (Premium Quality Made in the USA) Replaces: Prestolite - #8-117, 8-70, 8-74, GRX-761, VBE-6102A, VBE-6104A, VBO-4601F, VBO-4601K, VBO-4602B, VBO-4602R, VRB-4002C, VRP-4001A, VRP-4001B, VRP-4002D, VRP-4003A, VRP-4003B, VRP-4004A, VRP-4004C, VRP-4004F, VRP-4008A, VRP-6001A, VRP-6001B, VRP-6002A, VRP-6005A, VRP-6101A, VRP-6101B Chrysler - #1120515, 1121978, 1257394, 1321757, 1343573, 1571161, 2095209, 871763 Fits: Custom - Model B, C	

IDENTIFICATION TAGS

B9013-001	Small Autolite I.D. Tag (Blank)	\$7.00
	Small Autolite I.D. Tag (Stamped)	\$14.25
	2 5/16" Long, Black I.D. Tag for Distributors, Starters, & Generators with Rivets	

B9013-002	Large Autolite I.D. Tag (Blank)	\$7.00
	Large Autolite I.D. Tag (Stamped)	\$14.25
		2 15/16" Long, Black I.D. Tag for Distributors, Starters, & Generators with Rivets

AUXILIARY PLUG & SOCKET

B9032-001	2 Pole Auxiliary Plug	\$23.75
		Fits: Custom - Various Models
B9032-002	2 Pole Auxiliary Connector	\$19.75
		(Used With B9032-001) Fits: Custom - Various Models

GAUGES

Ammeters, Universal

B9025-002	Ammeter 20-0-20	\$19.99
		Has a black face with white lettering and a chrome bezel Does not have a logo Dimensions: Fits in 2" Diameter Hole 1.850" From Post to Bottom of Bezel

B9025-008	Ammeter 60-0-60	\$19.99
		Has a black face with white lettering & a chrome bezel Uses threaded terminals and is dash mounted Used with 12-Volt Alternator Systems Dimensions:Fits in 2" Diameter Hole Measures 1.765" from Top of Post to Bottom of Bezel

ALTERNATORS

Delco 10SI Type



B6001-001	12 Volt Alternator (1 Wire)	\$112.75
63 Amp, Low Cut In, Specially Built For Tractors, Forklifts, & Other Low Engine Speed Applications		
B6001-005	6 Volt Alternator (1 Wire, Positive Ground)	\$166.50
6 Volt, 40 Amp Alternator with Positive Ground, 1 Wire, 3/8" pulley		

SWITCHES

Push/Pull Switches

B5002-001	2 Position Push/Pull Switch	\$7.75
		OFF/ON Universal, 2 Position Push/Pull 2 Screw Terminals Mounting Stem 3/8"-32 Thread Knob #10/32 Thread

Key Switches

B5003-001	2 Position Battery Key Switch	\$14.75
		OFF/ON Universal, 2 Position Push/Pull 2 Screw Terminals Mounting Stem 3/4"-20 Thread

Small ND Type

B6002-003	12 Volt Small Denso Alternator (1 Wire)	\$119.75
		40 Amp, 1 Wire Internal Regulator. Will Start Charging with a Much Lower Engine Speed. Comes with a 4 1/2" Housing Diameter, 3/8 To 1/2" Belt width & a 2 1/2" Pulley Diameter. Excellent for Converting a 6 Volt System to 12 Volt. Negative Ground Only & is Self-Excited.

EMPIRE BATTERY CABLES



Empire Model 88 & 90 Tractors



B2015-001	Positive Battery Cable	\$31.50
B2000-007	Negative Ground Strap	\$14.50
B2015-003	Switch To Starter Cable	\$37.50

GAUGES

Ammeters, Universal

B9025-002	Ammeter 20-0-20	\$19.99
	Has a black face with white lettering and a chrome bezel Does not have a logo Dimensions: Fits in 2" Diameter Hole 1.850" From Post to Bottom of Bezel	

SWITCHES

B5002-001	2 Position Push/Pull Switch	\$7.75
	OFF/ON Universal 2-Position Push/Pull 2 Screw Terminals Mounting Stem 3/8"-32 Thread Knob #10/32 Thread	
B5003-001	2 Position Battery Key Switch	\$14.75
	Universal OFF/ON 2-Position Key Switch For Battery Ignition) 2 Screw Terminals Mounting Stem 3/4"-20 Thread	

IDENTIFICATION TAGS

B9013-001	Small Autolite I.D. Tag (Blank)	\$7.00
	Small Autolite I.D. Tag (Stamped)	\$14.25
	2 5/16" Long, Black I.D. Tag for Distributors, Starters, & Generators with Rivets	

B9013-002	Large Autolite I.D. Tag (Blank)	\$7.00
	Large Autolite I.D. Tag (Stamped)	\$14.25
	2 15/16" Long, Black I.D. Tag for Distributors, Starters, & Generators with Rivets	



ALTERNATORS

Delco 10SI Type

B6001-001	12 Volt Alternator (1 Wire)	\$112.75
63 Amp, Low Cut In, Specially Built For Tractors, Forklifts, & Other Low Engine Speed Applications		
B6001-005	6 Volt Alternator (1 Wire, Positive Ground)	\$166.50
6 Volt, 40 Amp Alternator with Positive Ground, 1 Wire, 3/8" pulley		

Small ND Type

B6002-003	12 Volt Small Denso Alternator (1 Wire)	\$119.75
	40 Amp, 1 Wire Internal Regulator. Will Start Charging with a Much Lower Engine Speed. Comes with a 4 1/2" Housing Diameter, 3/8 To 1/2" Belt width & a 2 1/2" Pulley Diameter. Excellent for Converting a 6 Volt System to 12 Volt. Negative Ground Only & is Self-Excited	

**For FARMALL,
see IHC/FARMALL**

**For FERGUSON,
see MASSEY
FERGUSON**

FORD TRACTOR

TABLE OF CONTENTS

Spark Plug Wire Sets	126
Battery Cables	127
Wire Harnesses	128
Replacement Distributors	130
Tune Up Parts for Distributors	130
Electronic Ignition Conversion Kits	131
Tune Up Parts for Magneto Ignition	132
Gauges	133
Terminal Blocks & Resistors	135
Cutout Relays & Voltage Regulators	135
Generator Repair Kits	136
Alternators	136
Alternator Conversion Kits	136
Lights & Light Parts	137
Switches & Solenoids	139
Cigarette Lighters	141
Carburetor Rebuild Kits	141
Carburetor Floats	142
Carburetor Accessories	143
Fuel Sediment Bowls	143
Fuel Sending Units	144

SPARK PLUG WIRE SETS

Our Spark Plug Wire Sets Come Fully Assembled with the Proper Type Wire & Terminals.

They are Custom Tailored to Look & Fit Like Original Factory Equipment.

Varieties include:

Cotton Braid Wire: Copper Core with a Cotton Jacket.

PVC Wire: Copper Core with a Rubber Jacket.

EPDM Wire (E): Hi Performance Premium Conductor with a Tinned Copper Core, EPDM Silicone Insulation, and a Rubber Jacket.

Suppression Wire (S): for Electronic Ignition and is Spiral Wound, Ultra Low-Ohm, with EPDM Silicone Insulation and a Rubber Jacket.

Cotton Braid Suppression Wire (CS): also for Electronic Ignition, as Suppression Wire, but has an additional layer of Cotton Braid & Lacquer to replicate the vintage look, as well.



Fordson F w/Buzz Coils

4 Cyl. Tailored Spark Plug Wire Set

1917-1926 (Replaces #S-750)

B1016-001	Original Type Cotton Braid Wire	\$36.50
B1016-001E	EPDM Wire	\$36.50

1927-1928 (Replaces #S-751)

B1016-076	Original Type Cotton Braid Wire	\$36.50
B1016-076E	EPDM Wire	\$36.50

(See Magneto Conversion for Fordson F, top of next column.)

Magneto Conversion for Fordson F; Replaces #S-757

B1016-077	Original Type Cotton Braid Wire	\$31.25
B1016-077E	EPDM Wire	\$34.00

Fordson N English 1919-1922

4 Cyl. Tailored Spark Plug Wire Set

B1016-002	Original Type Cotton Braid Wire	\$31.25
B1016-002E	EPDM Wire	\$34.00

Ford 2N, 8N (Up to Serial #263,843)

with Front Mount Distributor #9N-12100

4 Cyl. Tailored Spark Plug Wire Set

B1016-003	Original Type Cotton Braid Wire	\$26.25
B1016-003E	EPDM Wire	\$28.75
B1016-003S	Suppression Wire	\$28.75
B1016-003CS	Cotton Suppression Wire	\$45.25

Ford 8N w/Replacement Vertical Distributor

4 Cyl. Tailored Spark Plug Wire Set

B1016-004	Original Type Cotton Braid Wire	\$28.75
B1016-004E	EPDM Wire	\$31.25

Ford 8N (Serial #263,844 & Up)

with Side Mount Distributor

4 Cyl. Tailored Spark Plug Wire Set

B1016-005	Original Type Cotton Braid Wire	\$25.25
B1016-005E	EPDM Wire	\$27.25
B1016-005S	Suppression Wire	\$27.25
B1016-005CS	Cotton Suppression Wire	\$43.00

Ford 9N Series w/ Front Mount Distributor #9N-12100

4 Cyl. Tailored Spark Plug Wire Set

B1016-003	Original Type Cotton Braid Wire	\$26.25
B1016-003E	EPDM Wire	\$28.75
B1016-003S	Suppression Wire	\$28.75
B1016-003CS	Cotton Suppression Wire	\$45.25

Ford (1953-1964) NAA, NAB, Golden Jubilee, 501,

541, 600, 601, 611, 620, 621, 630, 631, 640, 641, 650, 651, 660, 661, 671 681, 700, 701, 740, 741, 771, 800, 801, 811, 820, 821, 840, 841, 850, 851, 860, 861, 871, 881, 900, 901, 941, 950, 951, 960, 961, 971, 981, 1801, 1811, 1821, 1841, 1881, 2000, 2030, 2031, 2110, 2111, 2120, 2130, 2131, 4000, 4030, 4031, 4040, 4110, 4120, 4121, 4130, 4131, 4140

4 Cyl. Tailored Spark Plug Wire Set

B1016-006	Original Type PVC Wire	\$20.50
B1016-006E	EPDM Wire	\$24.50
B1016-006S	Suppression Wire	\$24.50

Ford (1965 & Later) 2000, 2030, 2031, 2110, 2111,

2120, 2130, 2131, 3000, 4000, 4030, 4031, 4040, 4110, 4120, 4121, 4130, 4131, 4140

3 Cyl. Tailored Spark Plug Wire Set

B1016-075	Original Type EPDM Wire	\$31.50
B1016-075S	Suppression Wire	\$31.50

Ford 6000 6 Cyl. Tailored Spark Plug Wire Set

B1016-078	Original Type PVC Wire	\$35.75
B1016-078E	EPDM Wire	\$43.00

BATTERY CABLES



Our Battery Cables are made from the Proper Gauge Copper, as either Black Cotton Braided Wire or PVC Wire (whichever is correct for the application), using Soldered & Heat Sealed Brass or Copper Terminals.

Ford 2N

B2000-001	Positive Ground Strap	\$9.00
B2016-003	Negative Battery Cable	\$32.25
B2016-004	Switch To Starter Cable	\$23.50

Ford 8N

B2000-005	Positive Ground Strap	\$12.50
B2016-005	Negative Battery Cable	\$21.75
B2016-006	Switch To Starter Cable	\$23.75

Ford 9N (Up To Serial #12,499)

B2000-001	Positive Ground Strap	\$9.00
B2016-007	Negative Battery Cable	\$21.25
B2016-008	Switch To Starter Cable	\$33.00

Ford 9N (Serial #12,500 & Up)

B2000-001	Positive Ground Strap	\$9.00
B2016-009	Negative Battery Cable	\$32.25
B2016-010	Switch To Starter Cable	\$24.00

Ford NAA, NAB, Golden Jubilee

B2016-011	Positive Battery Cable	\$24.25
B2016-012	Negative Battery Cable	\$23.75
B2016-013	Switch To Starter Cable	\$24.00

4 Cyl. Ford 501, 541, 600, 601, 611, 620, 621, 630, 631, 640, 641, 650, 651, 660, 661, 671, 681, 700, 701, 740, 741, 771, 800, 801, 811, 820, 821, 840, 841, 850, 851, 860, 861, 871, 881, 900, 901, 941, 950, 951, 960, 961, 971, 981

Gas

B2016-020	Positive Battery Cable	\$28.50
B2016-021	Negative Battery Cable	\$27.75
B2016-022	Switch To Starter Cable	\$24.75

Diesel

B2016-061	Positive Battery Cable	\$33.75
B2016-062	Negative Battery Cable	\$32.75
B2016-063	Switch To Starter Cable	\$33.00

Ford 1800

B2016-023	Positive Battery Cable	\$24.50
B2016-024	Negative Battery Cable	\$24.00

Ford 2000 Gas

B2016-025	Positive Battery Cable	\$39.25
B2016-026	Negative Battery Cable	\$50.75
B2016-027	Switch To Starter Cable	\$21.25

4 Cyl. Ford 2000 Diesel (Early)

B2016-028	Positive Battery Cable	\$32.00
B2016-029	Negative Battery Cable	\$32.00
B2016-030	Switch To Starter Cable	\$36.50

3 Cyl. Ford 2000 Diesel (Late)

B2016-059	Positive Battery Cable	\$37.25
B2016-060	Negative Battery Cable	\$34.75

4 Cyl. Ford 3000 Gas (Early)

B2016-031	Positive Battery Cable	\$39.25
B2016-032	Negative Battery Cable	\$50.75
B2016-033	Switch To Starter Cable	\$36.50

4 Cyl. Ford 3000 Gas (Late)

B2016-034	Positive Battery Cable	\$39.25
B2016-035	Negative Battery Cable	\$50.75
B2016-036	Switch To Starter Cable	\$25.75

3 Cyl. Ford 4000 Gas

B2016-037	Positive Battery Cable	\$39.25
B2016-038	Negative Battery Cable	\$50.75
B2016-039	Switch To Starter Cable	\$25.25

4 Cyl. Ford 4000 Gas

B2016-040	Positive Battery Cable	\$25.25
B2016-041	Negative Battery Cable	\$25.25
B2016-042	Switch To Starter Cable	\$27.75

4 Cyl. Ford 4000 Diesel Row Crop (Early)

B2016-043	Positive Battery Cable	\$28.75
B2016-044	Negative Battery Cable	\$29.25
B2016-045	Switch To Starter Cable	\$31.25

3 Cyl. Ford 4000 Diesel Row Crop (Late)

B2016-046	Positive Battery Cable	\$44.00
B2016-047	Negative Battery Cable	\$50.75

Ford 4100 Diesel (Utility)

B2016-048	Positive Battery Cable	\$45.25
B2016-049	Negative Battery Cable	\$45.75

Ford 4500 Gas

B2016-050	Positive Battery Cable	\$39.25
B2016-051	Negative Battery Cable	\$50.75
B2016-052	Switch To Starter Cable	\$25.75

Ford 5000 Diesel

B2016-053	Positive Battery Cable	\$44.00
B2016-054	Negative Battery Cable	\$44.00

Ford 6000 Diesel (Late)

B2016-055	Positive Battery Cable	\$50.75
B2016-056	Negative Battery Cable	\$34.75

Ford 6600 Diesel

B2016-057	Positive Battery Cable	\$42.50
B2016-058	Negative Battery Cable	\$42.50



WIRING HARNESSSES

Our Wire Harnesses are made with our **premium cotton braid and/or PVC wire**.

They have the **correct gauge, color, wire, & fuse holders** (if needed).

All terminals are **soldered according to the original**.

(Harnesses do not include Battery Cables & Spark Plug Wires; however, we can supply these as separate products.)

NO HIDDEN COSTS, NOTHING EXTRA TO BUY!

Ford 2N

Complete Wire Harness

B3016-001	Original Design with Ammeter & Generator		\$186.50
B3016-076	Modified for 1 Wire Alternator		\$186.50
B3016-149	Modified for a 10SI (3 Wire) Alternator		\$186.50
B3016-230	Main Harness/ Basic Kit (1 Wire Alternator)	(Included with the Complete Harnesses Above)	\$38.75
B3016-081	Original Type Lighting Harness	(Included with the Complete Harnesses Above)	\$73.50

Ford 8N (Up to Serial #263,843)

Complete Wire Harness

B3016-002	Original Design with Ammeter & Generator		\$186.50
B3016-077	Modified for 1 Wire Alternator		\$186.50
B3016-150	Modified for a 10SI (3 Wire) Alternator		\$186.50
B3016-081	Original Type Lighting Harness	(Included with the Complete Harnesses Above)	\$73.50

Ford 8N (Serial #263,844 & Up)

Complete Wire Harness

B3016-003	Original Design with Ammeter & Generator		\$200.25
B3016-078	Modified for 1 Wire Alternator		\$200.25
B3016-151	Modified for a 10SI (3 Wire) Alternator		\$200.25
B3016-081	Original Type Lighting Harness	(Included with the Complete Harnesses Above)	\$73.50
B3016-229	Main Harness/ Basic Kit (1 Wire Alternator)	(Included with the Complete Harnesses Above)	\$53.50

Ford 9N

Complete Wire Harness

B3016-001	Original Design with Ammeter & Generator		\$186.50
B3016-076	Modified for 1 Wire Alternator		\$186.50
B3016-149	Modified for a 10SI (3 Wire) Alternator		\$186.50
B3016-081	Original Type Lighting Harness	(Included with the Complete Harnesses Above)	\$73.50
B3016-230	Main Harness/ Basic Kit (1 Wire Alternator)	(Included with the Complete Harnesses Above)	\$38.75

Ford NAA, NAB, Golden Jubilee (1953-1954)

Complete Wire Harness

B3016-005	Original Design with Ammeter & Generator		\$200.25
B3016-080	Modified for 1 Wire Alternator		\$200.25
B3016-153	Modified for a 10SI (3 Wire) Alternator		\$200.25
B3016-081	Original Type Lighting Harness	(Included with the Complete Harnesses Above)	\$73.50
B3016-231	Main Harness/ Basic Kit (1 Wire Alternator)	(Included with the Complete Harnesses Above)	\$38.75

4 Cyl. Ford Gas Models (1954-1957)

600, 620, 630, 640, 650, 660, 700, 740, 800, 820, 840, 850, 860, 900, 950, 960

Complete Wire Harness

B3016-005	Original Design with Ammeter & Generator		\$200.25
B3016-080	Modified for 1 Wire Alternator		\$200.25
B3016-153	Modified for a 10SI (3 Wire) Alternator		\$200.25
B3016-081	Original Type Lighting Harness	(Included with the Complete Harnesses Above)	\$73.50
B3016-231	Main Harness/ Basic Kit (1 Wire Alternator)	(Included with the Complete Harnesses Above)	\$38.75

4 Cyl. Ford Gas Models (1958-1964)

501, 541, 601, 611, 621, 631, 641, 651, 661, 671, 671, 681, 701, 741, 771, 801, 811, 821, 841, 851, 861, 871, 881, 901, 941, 951, 961, 971, 981, 1801, 1811, 1821, 1841, 1871, 1881, 2000, 2030, 2031, 2110, 2111, 2120, 2130, 2131, 4000, 4030, 4031, 4040, 4120, 4121, 4130, 4131, 4140

Complete Wire Harness

B3016-024	Original Design with Charge Indicator Light & Generator		\$223.50
B3016-099	Modified for 1 Wire Alternator		\$223.50
B3016-172	Modified for a 10SI (3 Wire) Alternator		\$223.50
B3016-224	Original Type Lighting Harness	(Included with the Complete Harnesses Above)	\$72.25

4 Cyl. Ford Diesel Models (1958-1964)

501, 541, 601, 611, 621, 631, 641, 651, 661, 671, 671, 681, 701, 741, 771, 801, 811, 821, 841, 851, 861, 871, 881, 901, 941, 951, 961, 971, 981, 1801, 1811, 1821, 1841, 1871, 1881, 2000, 2030, 2031, 2110, 2111, 2120, 2130, 2131, 4000, 4030, 4031, 4040, 4120, 4121, 4130, 4131, 4140

Complete Wire Harness

B3016-223	Original Design with Charge Indicator Light & Generator		\$223.50
B3016-227	Modified for a 10SI (3 Wire) Alternator		\$223.50
B3016-224	Original Type Lighting Harness	(Included with the Complete Harnesses Above)	\$72.25

3 Cyl. Ford Gas Models (1965-1973)

2000, 3000, 4000 (Prefix C with Generator)

Complete Wire Harness

B3016-225	Original Design		\$431.75
B3016-228	Modified for 10SI (3 Wire) Alternator		\$431.75
B3016-226	Original Type Lighting Harness	(Included with the Complete Harnesses Above)	\$72.25

3 Cyl. Ford Diesel Models (1971–end of production)

2000, 3000, 4000 (Prefix C with Generator)

Complete Wire Harness

B3016-232	Original Design		\$431.75
------------------	-----------------	--	-----------------

Ford 6000 Diesel

B3016-075	Complete Wire Harness		\$633.25
------------------	------------------------------	--	-----------------

Note

When ordering, please specify **Year** or **Serial Number**, Magneto/Distributor, & Regulator/Cut Out Relay.
Some Harnesses were originally made with PVC Wire & Braided; others were made with PVC Wire & Taped.
In all cases, we build them the **Original Way**.

REPLACEMENT DISTRIBUTORS

Ford 2N, (8N Early up to Serial #263,843), 9N

9N12100	Front Mount Distributor	\$129.75
 <p>4-Cylinder Complete New Replacement Distributor</p> <p>Front Mount Comes Complete (No Coil Included)</p>		

Ford 8N, Late Serial #263,844 & Up

8N12127B	Side Mount Distributor	\$129.75
 <p>4-Cylinder Complete New Replacement Distributor No Coil Included. Has External Oiler and Terminal for Coil Wire Original Style includes Cap and Rotor.</p> <p>For 8N's with the distributor mounted on the right-hand side of the engine – generator/alternator mounted on the left side as sitting in the seat.</p>		

Ford NAA, Jubilee, Golden Jubilee

FAC12127D	Slotted Drive Shaft Distributor	\$129.75
 <p>4-Cylinder Complete Replacement Distributor, New</p> <p>Fits: NAA, Jubilee, Golden Jubilee Replaces: #FAC12127D, 86643560</p>		

Ford 500 thru 4140

FDN12127A	1/4" Hex Drive Distributor	\$129.75
 <p>4-Cylinder Complete Replacement Distributor, New</p> <p>Fits (gas thru 1964): 1801, 1811, 1821, 1841, 1871, 1881, 2000 (4 Cyl), 2030, 2031, 2111, 2130, 2131, 4000 (4 Cyl), 4030, 4031, 4040, 4110, 4120, 4121, 4130, 4140, 501, 541, 600, 601, 611, 620, 621, 630, 631, 640, 641, 650, 651, 660, 661, 671, 681, 700, 701, 740, 741, 771, 800, 801, 811, 820, 821, 840, 841, 850, 851, 860, 861, 871, 881, 900, 901, 941, 950, 951, 960, 961, 971, 981</p> <p>Replaces: #311185, FDN12127A</p>		

Ford 3 Cyl. 2000 thru 4610

C7NF12127D	Ford Distributor	\$129.75
 <p>3 Cyl. Complete New Replacement Distributor</p> <p>Fits Tractors: 2000, 2100, 2110, 2120, 2150, 2300, 2310, 2600, 2610, 2810, 2910, 3000, 3055, 3100, 3110, 3120, 3150, 3330, 3400, 3500, 3600, 3610, 3910, 4000, 4100, 4110, 4140, 4200, 4330, 4350, 4400, 4500, 4600, 4600SU, 4610, 4610SU</p> <p>Fits Ford Construction & Industrial(s): 230A, 234, 334, 335, 340, 340A, 340B, 420, 445, 450, 3550 Replaces: #C7NF12127D, F0NN12100AA, F1NN12100AA, 47573265, 47821367</p>		

TUNE UP PARTS FOR BATTERY IGNITION



Fordson

with American Bosch Distributor Type T666

	B4001-004	\$45.00
	Points	

Ford 2N, 8N (Early, up to Serial #263,843), 9N with Front Mount Distributor #9N-12100

	B4100-009	\$11.75
	PCR Kit Includes: Points (#B4001-009), Condenser (#B4002-008), Rotor (#B4004-008) Replaces: Points - #DP-61, 8N-12107 Condenser - #91A-12300, DC-10 Rotor - #9N-12200	
	B4003-008	\$14.75
	Cap Replaces: #9M-12106	
	B4007-006	\$4.99
	Cap Clip Replaces: #9N12144 2 used per tractor Each sold separately	
	B4004-008	\$6.50
	Rotor Replaces: #9N-12200	

	B4005-001 Coil (6 Volt) Replaces: #9N-12024	\$35.75
	B4005-002 Coil (12 Volt) Replaces: #9N-12024	\$35.75
	B4008-002 Gasket Set Replaces: #9N-12104	\$5.75
	B9510-001 Ford Front Mount External Coil Connection Kit 12-Volt, Negative Ground	\$134.45
B4008-025	Breaker Plate Retaining Clip	\$5.99

Ford 4 CYL 8N (Late, with Ford Distributor #8N-121127B, Side Mount Distributor)
Fits (with Ford Distributor #FDN-12127, FDN-12127A): Golden Jubilee, NAA, NAB, 500 THRU 900, 2000, 2100, 2110, 3100, 3400, 4000, 4100, 4140, 4200

	B4100-005 PCR Kit Includes: Points (#B4001-010), Condenser (#B4002-009), Rotor (#B4004-009) Replaces: Points - #FAA-12171A (DP-3), 7RA-12171 (DP-7) Condenser - #7RA-12300, DC-6 Rotor - #1972022, DR-1	\$9.75
	B4004-009 Rotor Premium Grade, Made in the USA Replaces: #1972022, DR-1	\$4.75
	B4003-009 Distributor Cap Made in the USA (Brass Contacts) Replaces: #8N-12106, DH-78	\$14.25
	B4007-005 Rotor Clip Replaces: #8N-12213	\$4.25
	B4006-002 Dust Cover Replaces: #FAA-12239A	\$8.75

	B4009-004 Distributor Bushing & Shim Kit Replaces: Roll Pin: #60132, Bushing: #7RA12132A, Thrust Washer: #FAA12179A, Seal: #12476, D8NN12A118AA, O-Ring: #87055, 134372	\$34.99
--	---	----------------

*For 6-Volt Ignition Coils & Accessories, see p.44

Ford 3 Cyl. 2000, 2100, 2110, 3000, 3100, 3400, 4000, 4100, 4140, 4200, 7000

	B4100-006 PCR Kit Includes: Points (#B4001-011), Condenser (#B4002-010), Rotor (#B4004-010) Replaces: Points - #B7A-12171A, B8Q-12171A, DP-9 Condenser - #C5NF-12300A Rotor - #C5NF-1200A	\$12.75
	B4004-010 Rotor Premium Grade, USA Replaces: #C5NF-1200A	\$7.75
	B4006-005 Dust Cover Replaces: #81816627, C5NF12239A, C5NF12239AA, C7NF12239A	\$22.99
	B4003-010 Distributor Cap Replaces: #C5NF-12106A, DH-143 (Premium Grade, USA)	\$15.75

*For 6-Volt Ignition Coils & Accessories, see p.44

ELECTRONIC IGNITION CONVERSION KITS

Replaces Points & Condenser



Ford 2N, 8N, 9N with Front Mount Distributor (Uses Original Coil)		
B9600-183	12 Volt Negative Ground	\$159.95
B9600-183P6	6 Volt Positive Ground	\$185.95
Ford 2N, 8N, 9N with Front Mount Distributor (Uses External Replacement Pertronix Coil, included)		
B9600-183XT	12 Volt Negative Ground	\$298.95
B9600-183XTP6	6 Volt Positive Ground	\$309.45
B9503-005	Distributor Cap	\$37.45

Ford 8N with Distributor #8N-121127B (Side Mount) Golden Jubilee, NAA, NAB, 500 THRU 900, 2000, 2100, 2110, 3100, 3400, 4000, 4100, 4140, 4200 (all with #FDN-12127, FDN-12127A)		
B9600-031A	12 Volt Negative Ground	\$147.45
B9600-031AP12	12 Volt Positive Ground	\$165.45
B9600-031AN6	6 Volt Negative Ground	\$165.45
B9600-031AP6	6 Volt Positive Ground	\$165.45
B9600-031AII	12 Volt Negative Ground with Upgraded Current Protection	\$205.95



Ford 3 Cyl. 2000, 2100, 2110, 3000, 3100, 3400, 4000, 4100, 4140, 4200, 7000		
B9600-028	12 Volt Negative Ground	\$154.95

Ford 4 Cyl. 5000, 5100, 5000 Super, 6000, 6600		
B9600-225	12 Volt Negative Ground	\$154.95





***For Ignition Coils & Accessories, see p.44**

TUNE UP PARTS FOR MAGNETO IGNITION

Ford 9N with Fairbanks Morse Magneto #FMJ-E4B73		
	B4011-002 Points Replaces: #R2437	\$13.00
	B4012-004 Condenser Replaces: #SXY2433	\$11.00
	B4014-014 Rotor Replaces: #X2765	\$25.00
	B4015-002 Coil Replaces: #R2477C	\$39.75
	B4017-039 Distributor Shaft Bearing Replaces: #D5950C	\$6.75

	B4017-002 Rear Ball Bearing Replaces: #C5949	\$11.75
B4017-058	FMJ Distributor Shaft Clip	\$2.25
B4017-059	FMJ Distributor Shaft Washer	\$2.25
B4017-060	FMJ Distributor Shaft Felt Seal	\$1.75

With Fairbanks Morse Magneto #FMX-4C73 FMZ-V4C7, FMX-VE4C73		
	B4011-003 Points Replaces: #A2437A	\$18.50
	B4012-004 Condenser Replaces: #SXY2433	\$11.00



With WICO Magneto #XV4, XVD4, XV1509, XH1917, XV1966, XH1994, XV2065		
	B4011-004 Points Replaces: #1-5008, 1-5111, FXH-2100B, FXH-2400B, X5996	\$17.75
	B4012-002 Condenser Replaces: #2-5007, X5614, X6916	\$13.75
	B4017-040 Condenser Clamp Replaces: #94-5167	\$2.75
	B4013-032 Cap Includes its own gasket Replaces: #3-5001	\$38.00
	B4014-006 Rotor Replaces: #4-5018, FXH1008, X5531	\$8.25
	B4017-007 Impulse Spring Replaces: #94-5016	\$12.50
	B4016-012 Striker Plate Gasket Replaces: #94-5154	\$2.25

GAUGES



Ammeters, Universal

B9025-002	Ammeter 20-0-20	\$19.99
	Has a chrome bezel. Ford Fits: [2N, 8N, 9N, Golden Jubilee, Jubilee, NAA, 600, 620, 630, 640, 650, 660, 700, 740, 800, 820, 840, 850, 860, 900, 940, 950, 960 (All Ford models thru 1958 except Dextra & Fordson Major)] Replaces: FAD10850A	
B9025-005	Ammeter 30-0-30	\$19.99
	Has a black face with white lettering and a chrome bezel. Dimensions: Fits in a 2" Diameter Hole 1.740" From Top of Post to Bottom of Bezel	
B9025-008	Ammeter 60-0-60	\$19.99
	Has a black face with white lettering & a chrome bezel. Uses threaded terminals and is dash mounted. Used with 12-Volt Alternator Systems Dimensions: Fits in 2" Diameter Hole Measures 1.765" from Top of Post to Bottom of Bezel	

Oil Pressure Gauges

B9025-004	Universal Oil Pressure Gauge (0-50 PSI)	\$21.99
	Has 1/8" NPT male threads, studs, a bracket, chrome bezel, black face with white letters, & no logo. Dash-mounted, it requires a 2" diameter hole. Ford Replaces: #9N9273A Fits: 2N, 8N, 9N;	
B9025-001	Universal Oil Pressure Gauge (0-80 PSI)	\$24.99
	Has 1/8" NPT male threads, studs, a bracket, chrome bezel, black face with white letters, & no logo. Dash-mounted, it requires a 2" diameter hole. Ford Replaces: #FAD9273A Fits: NAA, 501, 541, 600, 601, 611, 620, 621, 630, 631, 640, 641, 650, 651, 660, 661, 671, 681, 700, 701, 740, 741, 771, 800, 801, 811, 820, 821, 840, 841, 850, 851, 860, 861, 871, 881, 900, 901, 940, 941, 950, 951, 960, 961, 971, 981, 1801, 1811, 1821, 1841, 1871, 1881, 2000 (4 cyl), 2030, 2031, 2110, 2111, 2120, 2121, 2130, 2131, 4000 (4 Cyl), 4030, 4031, 4040, 4110, 4120, 4121, 4130, 4131, 4140 (& others using 80 Lb. Gauge)]	

Oil Pressure Gauges, Ford

B9025-014	Oil Pressure Gauge (0-50PSI)	\$15.99
	Ford Replaces: #9N9273A Fits Models: 2N, 8N, 9N This Gauge is shipped with 1/8" male pipe threads	
B9025-074	Oil Pressure Gauge (0-80PSI)	\$15.99
	Has a Black Bezel with a Black Face and White Needle, 1/8" Male Pipe Threads. Ford Replaces: #FAD9273A Fits: Golden Jubilee, Jubilee, NAA, NAB, 2000 4 cylinder, 2031, 2111, 2131, 2N, 4000 4 cylinder, 4031, 4110, 4120, 4121, 4140, 501, 541, 600, 601, 611, 620, 621, 630, 631, 640, 641, 650, 651, 660, 661, 671, 681, 700, 701, 740, 741, 771, 800, 801, 811, 820, 821, 840, 841, 850, 851, 860, 861, 871, 881, 8N, 900, 901, 941, 950, 951, 960, 961, 971, 981, 9N (All 4 cylinder gas, LP & Diesel thru 1964); Industrial: 1801, 1811, 1821, 1841, 1871, 1881, 2030, 2130, 4030 4 cylinder, 4040, 4130 4 cylinder (All 4 cylinder gas, LP & Diesel thru 1964)	

Oil Pressure Gauge, Line Kit

B9026-001	Oil Pressure Gauge Line Kit	\$29.99
	6 FT copper 1/8" line --- Kit includes: (2) 5/16 - 24 UNF nut, (2) compression sleeves, (1) 1/8 - 27 NPTF female to 5/16" - 24 UNF male adapter --- Note: Depending on application customer may be required to purchase other fittings.	
B9026-004	Oil Pressure Gauge 1/4" to 1/8" NPT Adapter Fitting	\$15.99
	Adapter Fitting for Oil Gauges – 1/4" to 1/8" NPT. Ford Fits: Jubilee, NAA, NAB, 2000 4 cylinder, 2111, 2120, 2N, 4000 4 cylinder, 4121, 4140, 501, 541, 600, 601, 611, 620, 621, 630, 631, 640, 641, 650, 651, 661, 671, 681, 700, 740, 741, 771, 800, 801, 811, 820, 821, 840, 841, 850, 851, 860, 861, 871, 881, 8N, 900, 901, 941, 950, 951, 960, 961, 971, 981, 9N (ALL 1939-1964 & Other Models Using Mechanical Gauge)	

Water Temperature Gauges, Ford

B9025-003	Ford Water Temperature Gauge, Chrome Bezel	\$32.99
	<p><i>Includes Aluminum Sealing Washer To Seal Probe</i> No logo included, has a black face with white letters and a chrome bezel. Dash-mounted, requires a 2" diameter hole. Ford Replaces: #C3NN18287A Fits Models (All 4 cylinder Gas, LP & Diesel thru 1964): Golden Jubilee, Jubilee, NAA, NAB, 501, 541, 600, 601, 611, 620, 621, 630, 631, 640, 641, 650, 651, 660, 661, 671, 681, 700, 701, 740, 741, 771, 800, 801, 811, 820, 821, 840, 841, 850, 851, 860, 861, 871, 881, 900, 901, 941, 950, 951, 960, 961, 971, 981, 1801, 1811, 1821, 1841, 1871, 1881, 2000 (4 Cyl), 2030, 2031, 2111, 2130, 2131, 4000 (4 Cyl), 4030, 4031, 4040, 4110, 4120, 4121, 4130, 4140</p>	

B9025-075	Ford Water Temperature Gauge, Black Bezel	\$33.99
	<p>Has a black bezel with a black face and white letters, no logo included. Dash-mounted, requires a 2" diameter hole. Ford Replaces: # C3NN18287A Fits Models: Golden Jubilee, Jubilee, NAA, NAB, 2N, 8N, 9N, 501, 541, 600, 601, 611, 620, 621, 630, 631, 640, 641, 650, 651, 660, 661, 671, 681, 700, 701, 740, 741, 771, 800, 801, 811, 820, 821, 840, 841, 850, 851, 860, 861, 871, 881, 900, 901, 940, 941, 950, 951, 960, 961, 971, 981, 2000 4-cylinder, 2031, 2111, 2131, 4000 4-cylinder, 4031, 4110, 4120, 4121, 4140</p>	

Fuel Gauges, Ford

B9025-049	Ford Fuel Gauge, 12-Volt Negative Ground	\$32.99
	<p>For 12-Volt Negative Ground Systems. Anodized Metal Body with Black Raised Bezel. 14 – 122 Ohm Range. Comes with Nitride Rubber Gasket. Fits in 2" Diameter Hole. Must be grounded properly to Work. Ford Replaces: #310949 Fits (all 4 cylinder gas/dsl models, 1958 – 1964): 1801, 1811, 1821, 1841, 1871, 1881, 2000 4 cylinder, 2030, 2031, 2111, 2130, 2131, 4000 4 cylinder, 4030 4 cylinder, 4031, 4040, 4110, 4120, 4121, 4130 4 cylinder, 4140, 501, 541, 601, 611, 621, 631, 641, 651, 661, 671, 681, 701, 741, 771, 801, 811, 821, 841, 851, 861, 871, 881, 901, 941, 951, 961, 971, 981</p>	

B9025-080	Ford Fuel Gauge, 6-Volt Positive Ground	\$32.99
	<p>Has a Raised, Black Bezel. 14 to 122 Ohm Range, Must be Grounded Properly to Work. Ford Replaces: #310948 Fits (4-cylinder gas models 1958-1964): 501, 541, 601, 611, 621, 631, 641, 651, 661, 671, 681, 701, 741, 771, 801, 811, 821, 841, 851, 861, 871, 881, 901, 941, 951, 961, 971, 981, 2000, 2031, 2111, 2131, 4000, 4031, 4110, 4120, 4121, 4140 Industrials: 1801, 1811, 1821, 1841, 1871, 1881, 2030, 2130, 4030 4-cylinder, 4040, 4130 4-cylinder</p>	

Cluster Gauges, Ford

B9026-007	Ford Cluster Gauge Gasket	\$19.99
	<p><u>Measures 9.1" at widest by 4" tall.</u> Replaces: #C5NN10A949C Fits: 2000 (3-cylinder), 2110, 2120, 2300, 2310, 2600, 2610, 2810, 2910, 3000, 3100, 3120, 3300, 3310, 3600, 3610, 3910, 4000 (3-cylinder), 4000SU, 4600SU, 4100, 4110, 4600, 4610, 5000, 5100, 5200, 5600, 5610 (up to 11/1987), 5900, 6600, 6610 (up to 9/1985) 7000, 7100, 7200, 7400, 7600 Industrials: 231, 250C, 335, 340, 340B 445, 531, 540, 3400, 3500, 3550, 4400, 4500</p>	

Tachometers, Ford

B9025-076	Ford 4-Speed Tachometer / Proofmeter	\$56.75
	<p>Has Black & White Face with Black Bezel. Includes a restoration quality OEM style needle. 3.320" housing outside diameter 2.063" housing length (depth). Ford Fits: NAA, 500-4000 series 1953-1964 Replaces: #C3NN17360N</p>	

Tachometer Drive Cables



B9026-005	30 1/2" Tachometer Drive Cable	\$15.99
	<p>Restoration Quality. Drive Cable for Tachometers. Measures 29 7/8" Outer Sheath Length. 5/8"-18 x 7/8"-18 Threads With Key On One End. Check Length Before Ordering. Ford Replaces: #B9NN17365B Fits: 4-cylinder gas, LP, Diesel, 1953 thru 1964 with 4-, 5- and 10- speed transmissions</p>	

TERMINAL BLOCKS & RESISTORS

B9031-001	Terminal Junction Block	\$12.99
	Replacement Terminal Junction Block Ford Replaces: #8N14448A Fits 8N Serial #263844 & up (with Side Mount Distributor), NAA, Golden Jubilee, [500-4000 4 Cyl.]	
B9031-002	Ford Resistor Assembly	\$21.99
	Resistor Assembly with 3/16" Machine Screw Mount Ford Fits: 8N (up to SN #263844) Replaces: #A8NN12250A	
B9031-003	Ford Resistor Assembly	\$21.99
	Resistor Assembly with 5/16" Machine Screw Mount <i>OEM Style</i> Ford Fits: 2N, 9N Replaces: #A8NN12250B	

CUTOUT RELAYS & VOLTAGE REGULATORS

Note: Due to modern battery design, voltage regulators can't be used to charge low or dead batteries. Doing so will destroy the voltage regulator and void the warranty.

B8001-005	6-Volt Cutout Relay	\$30.25
	3 Terminal Ford Replaces: B0NN10505A Fits: 2N, 8N	
Ford Type Voltage Regulator		
B8002-010	Premium Quality, Made in the USA	\$113.25
B8002-049	Standard Quality	\$43.75
	6 Volt, 'B' Circuit, Positive Ground, 3 Terminals, Flat Mounting Bracket Ford Replaces Ford #FAG-10505A, GR277 Fits: (all 4-cylinder gas, 1953 thru 1964)-2000 4-cylinder, 4000 4-cylinder, Golden Jubilee, Jubilee, NAA, NAB, 501, 541, 600, 601, 611, 620, 621, 630, 631, 640, 641, 650, 651, 660, 661, 671, 681, 700, 701, 740, 741, 771, 800, 801, 811, 820, 821, 840, 841, 850, 851, 860, 861, 871, 881, 900, 901, 941, 950, 951, 960, 961, 971, 981, 1801 with Generator #FAC-10002A, 1811, 1821, 1841, 1871, 1881, 2030, 2031, 2111, 2130, 2131, 4030, 4031, 4040, 4110, 4120, 4121, 4130, 4140	



B8002-009	Ford Type Voltage Regulator	\$64.75
	6 Volt, 3 Terminals, Flat Mounting Bracket Ford Replaces: #8N-10505B, 8N-10505C, GR276 Fits: 8N (Serial #263,844 & Up) with Generator #8N10001 Premium Quality, Made in the USA	

B8002-021	12-Volt Ford Type Voltage Regulator	\$64.50
	12 Volt, 3 Terminals, Flat Mounting Bracket, 'B' Circuit, Positive or Negative Ground Replaces: Delco - #1972067, 1972070 Ford - #B8E-10505-B, B8E-10505-C, COMF-10505-A, C2AF-10505-B, C2AZ-10505-B, C2AZ-10505-C, C2TZ-10505-A, D2AZ-10505-C, FBF10505A, GR369 Prestolite - #8-622 Fits: Ford (12-volt Gas, LP or Dsl) - Jubilee, NAA, NAB, 501, 541, 600, 601, 611, 620, 621, 630, 631, 640, 641, 650, 651, 660, 661, 671, 681, 700, 740, 741, 771, 800, 801, 811, 820, 821, 840, 841, 850, 851, 860, 861, 871, 881, 900, 901, 941, 950, 951, 960, 961, 971, 981, 1801 (with Generator #B9NF-10002A), 1811, 1821, 1841, 1871, 1881, 2000 (4-cylinder), 2030, 2111, 2120, 2130, 4000 (4-cylinder), 4030, 4040, 4121, 4130, 4140 Premium Quality, Made in the USA	

B8002-026	12-Volt Lucas Type Voltage Regulator	\$34.75
	12 Volt, 6 Terminals, Flat Mounting Bracket Regulator Fits: Ford -2000, 3000, 4000, 5000, 6000, 7000, 8000 With Generator #C7NN-1000C, & C7NN-C Replaces: Ford - #105E-10505-C, 3004E-10505-A, 622E-10505-A, 71AB-10505-BA, C5NF-10505-B, C7NN-10505-B, C7NN-10505-C, C7NN-10505-E, D0NN-10505-A Lucas Industries - #37207, 37279, 37292, 37297, 37299, 37304, 37323, 37330, 37334, 37336, 37342, 37344, 37346, 37362, 37367, 37368, 37382, 37391, 37392, 37451, 37452, 37471, 37472, 37477, 37528, 37529, 37542, 37543, 37544, 37547, 37559, 37562, 37563, 37568, 37569, 37570, 37571, 37572, 37573, 37576, 37577, 37597, LRC111, LRC113, LRC119, NCB130, NCB131, NCB132, NCB133, NCB134	

B8002-032	12-Volt Lucas Type Voltage Regulator	\$113.75
	12 Volt, 6 Terminals, Flat Mounting Bracket Regulator Fits: Ford -2000, 3000, 4000, 5000, 6000, 7000, 8000 With Generator #C7NN-1000C, & C7NN-C Replaces: Ford - #105E-10505-C, 3004E-10505-A, 622E-10505-A, 71AB-10505-BA, C5NF-10505-B, C7NN-10505-B, C7NN-10505-C, C7NN-10505-E, D0NN-10505-A Lucas Industries - #37207, 37279, 37292, 37297, 37299, 37304, 37323, 37330, 37334, 37336, 37342, 37344, 37346, 37362, 37367, 37368, 37382, 37391, 37392, 37451, 37452, 37471, 37472, 37477, 37528, 37529, 37542, 37543, 37544, 37547, 37559, 37562, 37563, 37568, 37569, 37570, 37571, 37572, 37573, 37576, 37577, 37597, LRC111, LRC113, LRC119, NCB130, NCB131, NCB132, NCB133, NCB134 Premium Quality, Made in the USA	

GENERATOR REPAIR KITS

5794RK	Ford Generator Repair Kit	\$18.75
	6-Volt, for Cutout Relays. Includes: 1 Bearing, 1 Bushing, & 3 Brushes Ford Fits: 8N (Serial #263,844 & Up)	
5798RK	Ford Generator Repair Kit	\$13.75
	6-Volt. Includes: 1 Bearing, 1 Bushing, & 2 Brushes Ford Fits: 8N (Serial #263,844 & Up with Generator 8N-10001)	



ALTERNATORS



Delco 10SI Type

B6001-002	12 Volt Alternator (1 Wire/ 3 Wire)	\$118.75
63 Amp, With 1 Wire Or 3 Wire For Warning Lamp On Automobiles & Trucks		
B6001-005	6 Volt Alternator (1 Wire, Positive Ground)	\$166.50
40 Amp Alternator with Positive Ground, 1 Wire 3/8" Pulley		
B6001-012	12 Volt Alternator (1 Wire, 1/2" Pulley)	\$111.25
63 Amp, Low Cut In, Specially Built For Tractors, Forklifts, & Other Low Engine Speed Applications, 1/2" Pulley Fits Ford – 500-900 with Ammeter, 1954-1957		
B6001-013	12 Volt Alternator (1 Wire, 5/8" to 3/4" Pulley)	\$113.75
63 Amp, Negative Ground, 5/8" to 3/4" Pulley Fits Ford – 2N, 8N, 9N, NAA, Golden Jubilee, NAB		
B6001-014	12 Volt Alternator (1 Wire/3 Wire, 1/2" Pulley)	\$129.75
As B6001-002, but has a 1/2" Pulley. Fits Ford – 501-4000 (4 Cyl), 1958-1964		

Small ND Type

B6002-003	12 Volt Small Denso Alternator (1-Wire)	\$119.75
	40 Amp, 1 Wire Internal Regulator. Will Start Charging with a Much Lower Engine Speed. Comes with a 4 1/2" Housing Diameter, 3/8 To 1/2" Belt width & a 2 1/2" Pulley Diameter. Excellent for Converting a 6 Volt System to 12 Volt. Negative Ground Only & is Self-Excited	

ALTERNATOR CONVERSION BRACKETS

B9014-008	Ford Alternator Conversion Bracket w/ Belt Tensioning Arm	\$48.75
	Fits 2N, 8N (Up to Serial #263843), 9N -All with Front Mount Distributors- Made in the USA	
B9014-009	Ford Alternator Conversion Bracket w/ Belt Tensioning Arm	\$45.00
	Fits: 8N (Late - SN 263844 & up) with Side Mount Distributors Distributor is mounted to the right side of engine & Generator is mounted on left side Made in the USA	
B9014-010	Ford Alternator Conversion Bracket w/ Belt Tensioning Arm	\$42.50
	Fits: Jubilee, NAA, 501, 600, 700, 800, 900, 1801, 2000 (4-cylinder), 4000 (4-Cylinder), 4030, 4031, 4040, 4120, 4130, 4131, 4140 (thru 1964) Made in the USA	

ALTERNATOR CONVERSION KITS

Our kits are used to convert from a generator to an alternator, and use the Original Alternator Mounting Bracket & Top Adjusting Arm.

Each includes parts to convert Ford Tractors from the Original 6-Volt Positive Ground Generator System to a 12-Volt Negative Ground Alternator System:

- 12-Volt Alternator with Correct Pulley
- Alternator Mounting Bracket
- Charging System Harness
- 12-Volt Coil (Internally Resisted)

B9021-003	Early Ford Tractor with Front-Mounted Distributor Conversion Kit	\$185.75
	*Also includes an Alternator Serpentine Belt Ford Fits (with Front-Mount Distributors) - 2N, 9N (1935-1950 All - Distributor mounts under fan/water pump), 8N (Early) - Up to Serial #263843 (1939-1950) Note: This is for Ford tractors with Front Mount Distributors Only (behind the fan blade). Alternator is mounted on the Right side of the tractor from sitting in the seat. For starting and lighting, use original harness. Lights and Ampere Gauges are sold separately. For 12-Volt Ampere Gauge, use #B9025-008.	

B9021-008	Late Ford Tractor (to 1952) with Side-Mounted Distributor Conversion Kit	\$179.75
 <p>*Also includes a Custom Wire Harness Fits: Ford - 8N (Late) - Serial #263844 and up (1950-1952) with Side-Mount Distributor (Distributor is mounted to the right side of engine & alternator is mounted on left side)</p>		

B9021-010	1953-1957 Ford 4-Cylinder Gas Tractor Conversion Kit	\$187.75
 <p>*Also includes a Custom Wire Harness Fits: Ford - NAA, Golden Jubilee, 600, 620, 630, 640, 650, 660, 700, 740, 800, 820, 840, 850, 860, 900, 950, & 960</p>		

B9017-097	12-Volt LED Lamp, Trapezoid Beam Pattern	\$49.99
 <p>Ford Replaces: #277073, 312555, 80277073 Fits: 750, 755, 2310, 2610, 2810, 2910, 3610, 3910, 3930, 4200, 4600, 4600SU, 4610, 5200, 5600, 5610, 5900, 6600, 6610, 7000, 7200, 7600, 7610, 8000, 8200, 8400, 8600, 9000, 9200, 9600 (all w/ flat top fenders)</p>		

B9017-098	12-Volt LED Lamp, Flood Beam Pattern	\$49.99
 <p>Ford Replaces: CONN15330A, C5NN13007F, E3NN15330AA GE: #4410, 4411 Fits (w/ flat top fenders/ cab): 750, 755, 2310, 2600, 2610, 2810, 2910, 3600, 3610, 3910, 3930, 4200, 4600, 4600SU, 4610, 5200, 5600, 5610, 5900, 6600, 6610, 7000, 7200, 7600, 7610, 8000, 8200, 8400, 8600, 9000, 9200, 9600 (compact) 1100, 1110, 1200, 1210, 1300, 1310, 1500, 1510, 1710, 1900, 1910, 2110. Industrials: A62, A64, A66 (w/ flat top fenders / cab): 755A, 755B, 6500, 7500</p>		

LIGHTS & LIGHT PARTS

Sealed Beam Head Lamp Assembly for Flat Top Fenders		
B9016-022	12 Volt Low Beam	\$39.99
B9016-023	12 Volt High Beam	\$59.75
B9016-080	12 Volt LED Trapezoid	\$67.99
B9016-081	12 Volt LED Flood Light	\$67.99
 <p>Ford Replaces: #D9NN13005CA, D4NN13002C Fits: 755, 2310, 2600, 2610, 2810, 2910, 3600, 3610, 3910, 3930, 4200, 4600, 4600SU, 4610, 5200, 5600, 5610, 5900, 6600, 6610, 7000, 7200, 7600, 7610, 8000, 9000, TW5, TW10, TW15, TW20, TW25, TW30, TW35</p>		

B9016-062	12V Headlight Assembly	\$49.99
 <p>12 Volt 5 3/4" Headlight. Stamped: TRACT-O-LITE on housing. Ford Replaces: #2N13005C, 310068 Fits: 515, 532, 535, 1801, 1811, 1821, 1841, 1871, 1881, 2000 3 cylinder, 2000 4 cylinder, 2030, 2031, 2100, 2111, 2130, 2131, 2150, 2300, 2310, 2600, 2610, 2810, 2910, 3000, 3600, 3610, 3900, 3910, 4000 3 cylinder, 4000 4 cylinder, 4030 3 Cylinder, 4031, 4040, 4120, 4121, 4130 3 Cylinder, 4100, 4110, 4131, 4140, 4200, 4330, 4340, 4410, 4600, 4610, 5000, 5100, 5200, 5600, 5700, 6600, 6700, 7000, 7100, 7200, 7600, 7700 When converted to 12 volt systems: 501, 541, 600, 601, 611, 620, 621, 630, 631, 640, 641, 650, 651, 660, 661, 671, 681, 700, 701, 740, 741, 771, 800, 801, 811, 820, 821, 840, 841, 850, 851, 860, 861, 871, 881, 900, 901, 941, 950, 951, 960, 961, 971, 981.</p>		

PARTS FOR LIGHT ABOVE		
B9017-031	Sealed Beam, 12 Volt High Beam	\$18.99
B9017-032	Sealed Beam, 12 Volt Low Beam	\$16.50
 <p>4 1/2" diameter Double Contact Light Bulb 4.365" Outside Diameter</p>		
		B9017-009 \$5.99
Concave Light Mounting Washer/Retainer		

B9016-063	6V Headlight Assembly	\$52.99
 <p>6 Volt 5 3/4" Headlight. Stamped: TRACT-O-LITE on housing. Ford Replaces: #2N13006C, 310066 Fits: 2N, 8N, 9N, Golden Jubilee, Jubilee, NAA, NAB, 501, 541, 600, 601, 611, 620, 621, 630, 631, 640, 641, 650, 651, 660, 661, 671, 681, 700, 701, 740, 741, 771, 800, 801, 811, 820, 821, 840, 841, 850, 851, 860, 861, 871, 881, 900, 901, 941, 950, 951, 960, 961, 971, 981</p>		

PARTS FOR LIGHT ABOVE		
B9017-033	Sealed Beam, 12 Volt Bulb	\$14.75
B9017-034	Sealed Beam, 6 Volt Bulb	\$19.75
	Double Contact High Beam 35 Watts with a 5.625" Outside Diameter	

B9016-064	12V Rear Work Light Assembly	\$109.99
	12 Volt Rear Work Light with Sealed Beam Bulb and On/Off Switch. Uses 4 1/2" Sealed Beam Bulbs. Outside Diameter is 5 1/4". Ford Replaces: #8N15500 Fits: Golden Jubilee, Jubilee, NAA, NAB, 2000 4 cylinder, 2031, 2110, 2111, 2120, 2131, 4000 4 cylinder, 4031, 4110, 4120, 4121, 4131, 4140, 501, 541, 600, 601, 611, 620, 621, 630, 631, 640, 641, 650, 651, 660, 671, 681, 700, 701, 740, 741, 771, 800, 801, 811, 820, 821, 840, 841, 850, 851, 860, 861, 871, 881, 8N, 900, 901, 941, 950, 951, 960, 961, 971, 981 (Following 4 cylinder using 12 volt system thru 1964)	

PARTS FOR LIGHT ABOVE		
B9017-032	Sealed Beam, 12 Volt Low Beam	\$16.50
	Double Contact Light Bulb 35 Watts 4.365" Outside Diameter	

B9016-054	Round Fender & Cab Mount Warning Light	\$19.99
	Restoration Quality 12 Volt Round Light with 2 x 4" Diameter Amber Lenses, Double Contact Bulb, 1/2" Diameter Stud, & 2.4" Thick at Widest Point. Ford Replaces: #C5NNA3N359E, D4NN13N359A, D6NN13N359B, D9NN13N359AA Fits: TW10, TW20, TW30, [2000 3 cylinder, 4000 3 cylinder (3 cylinder)], 2110, 2120, 2300, 2310, 2600, 2610, 2810, 2910, 3000, 3100, 3120, 3230, 3300, 3310, 3330, 3600, 3610, 3830, 3910, 3930, 4100, 4110, 4130 3 Cylinder, 4330, 4610, 4630, 4830, 5000, 5030, 5100, 5200, 5340, 5530, 5600, 5610, 5700, 5900, 6600, 6610, 6700, 6710, 7000, 7100, 7200, 7400, 7600, 7610, 7700, 7710, 7810, 8000, 8200, 8400, 8600, 8700, 9000, 9600, 9700, Industrial: 230A, 250C, 260C, 335, 340, 3400, 340B, 345C, 345D, 3500, 3550, 420, 4400, 445, 445A, 445C, 445D, 450, 4500, 515, 532, 535, 540A, 540B, 545, 545A, 545C, 545D, 550, 5500, 555A, 555B, 555C, 650, 6500, 655, 655A, 655B, 655C, 750, 7500, 755, 755A, 755B	

B9016-055	Rectangular Fender & Cab Mount Warning Light	\$32.99
	Restoration Quality 12 Volt Rectangular Light One Red and One Amber Lens With Amber Side Marker 4.5" Wide & 1/2" Diameter Stud Ford Fits: [T25, TW10, TW15, TW25, TW35, 2000 3 cylinder, 231, 2310, 233, 234, 2600, 2610, 2810, 2910, 3000, 335, 340, 3400, 3500, 3600, 3610, 3910, 3930, 4000 3 cylinder, 4100, 4110, 420, 4400, 445, 4500, 4600, 4610, 5000, 5100, 515, 5200, 530A, 531, 532, 535, 540, 550, 5600, 5610, 6600, 6610, 6700, 6710, 7000, 7100, 7200, 7600, 7610, 7710, 7810, 8000, 8600, 8700, 9000, 9600, 9700 (Serviceable for models with rectangular warning lights)]	

B9016-065	Indicator Light	\$15.99
	0.875" Diameter, 3/4" - 20 NF Thread, 0.885" Tall. Includes 'PAL' Nut. Bulb and Socket Not Included. Ford Replaces: #310124, 373348S, B9NN10241B Fits: (As a generator warning light for 4-cylinder 1957-1964 models): 501, 541, 611, 621, 631, 641, 651, 661, 671, 681, 741, 771, 811, 821, 841, 851, 861, 871, 881, 941, 951, 961, 971, 981, 2031, 2110, 2111, 2120, 2121, 2131, 4031, 4110, 4120, 4121, 4131, 4140 (As a select-o-speed transmission oil temperature warning light): 611, 671, 681, 771, 811, 871, 881, 971, 981, 2000 3-cylinder, 2000 4-cylinder, 2100, 2110, 2111, 2120, 3000, 4000 3-cylinder, 4000 4-cylinder, 5000, 3100, 3110, 3120, 4100, 4110, 4121, 4130 3-cylinder, 4140, 5100, 5110 (As a torque converter transmission oil temperature warning light): 535, 550, 555 *Used with B9017-096, Isolated Lamp Pigtail for 5/8" Hole	

DASH LAMPS

Ford Dash Lamp		
B9016-051	(6 Volt)	\$26.99
B9016-052	(12 Volt)	\$26.99
	6 or 12 Volt, Black Finished Dash Lamp. <u>Replacement Bulb</u> 6 Volt Use Bulb #B9017-046, 12 Volt Use Bulb #B9017-049 Ford Replaces: #NCA13771A, #C3NN14662A, #19B-13466 Fits: Golden Jubilee, Jubilee, NAA, NAB, 600, 620, 630, 640, 650, 660, 700, 740, 800, 820, 840, 850, 860, 900, 950, 960	

Light Bulbs



B9017-046	6 Volt Bulb	\$1.25
B9017-049	12 Volt Bulb	\$1.25
	Light bulbs for products #B9016-051, B9016-052	

SWITCHES & SOLENOIDS

KEY SWITCHES

B5003-015	Ford Replacement Ignition Switch	\$9.75
	Replacement Ignition Switch for Ford 9N, 2N, 8N, & 500-4000 1939 to 1964 Except for Dextra, & Fordson Major Replaces: #8N3679C	
B5003-008	Ignition Key Switch	\$24.99
	Includes 2 Keys, 2 Spade Terminals Designed for 0.800" hole diameter. Ford Replaces: #B5003-015 Fits (4-cylinder gas, LP & diesel, 1939 - 1964 except Fordson Dextra & Major): 2000 4-cylinder, 2N, 4000 4-cylinder, 8N, 9N, Golden Jubilee, Jubilee, NAA, NAB, 501, 541, 600, 601, 611, 620, 621, 630, 631, 640, 641, 650, 651, 660, 661, 671, 681, 700, 701, 740, 741, 771, 800, 801, 811, 820, 821, 840, 841, 850, 851, 860, 861, 871, 881, 900, 901, 941, 950, 951, 960, 961, 971, 981, 1801, 1811, 1821, 1841, 1871, 1881, 2030, 2031, 2111, 2130, 2131, 4030, 4031, 4040, 4110, 4120, 4121, 4130, 4140	
B5003-018	Ford Ignition Key Switch	\$16.99
	For Gas & Diesel Tractors With or Without Cold Start. Positions (Left to Right) - OFF - ON - 2nd ON (Diesel) - Cold Start - Crank. For Cold Start Rotate Key Clockwise Half Way to the Right after ON Position. For Full Crank Turn Key All the Way to the Right. Has 7 Spade Terminals. Threaded Stem Measures 3/4-27 UNS. Ford Replaces: #82849085, C5NN11N501A, C5NN11N572A, D5NN11572A, E7NN11N501AC, E8NN11N501AA Fits (1965 and up): TW10, TW30, 2000 (3-cylinder), 2310, 2600, 2610, 2810, 2910, 3000, 3010S, 3230, 3310, 3330, 3550, 3600, 3610, 3910, 3930, 4000 3 cylinder, 4100, 4110, 4600, 4630, 5000, 5100, 5110, 5200, 5600, 5610, 5700, 5900, 650, 6600, 6610, 6710, 6810, 7000, 7100, 7200, 7410, 7600, 7610, 7700, 7710, 7810, 7910, 8000, 8010, 8210, 8530, 8630, 8700, 8730, 8830, 9000, 9700	
B5003-028	Ignition Switch with 5 Terminals, 2 Keys, and a Weather Cap	\$49.99
	Includes: 5 screw terminals with preheat, 2 keys, weather cap Ford Replaces: #SBA385200331, SBA385201250, SBA385201700 Fits: 1320, 1520, 1600, 1620, 1710, 1715, 1720, 1910, 1920, 2110 (Japan built compact), 2120 (Japan built compact), 3415 Skid Steers - CL25, CL55, CL35, CL65, CL45 (see www.brillman.com for additional fits)	

MOMENTARY SWITCHES

B5004-003	Momentary Push Switch	\$15.75
	Manual Push Button Solenoid Switch with Rubber Protected Cap (2 Screw Terminals) Mounting Stem 5/8"-32 Thread Ford Fits: (Various)	
B5006-001	Starter Switch (Long Shaft)	\$12.75
	6 or 12 Volt Panel Mounted Manual Push Start Switch Ford Replaces: #9N11450A Fits: 9N (Up to Serial #12499)	

PUSH/PULL SWITCHES

B5002-010	Light Switch	\$16.00
	Like Original Ford Replaces: #9N11652, 9N11652B, 830517M91 Fits: 2N, 8N, 9N	
B5002-013	Light Switch with Fuse	\$13.75
	Ford Replaces: #87518815, 8N11654B Fits: 2N, 8N, 9N, Jubilee, NAA	
B5002-014	Knurled Knob Light Switch with Fuse	\$15.75
	Ford Replaces: #87518815, 8N11654B Fits: 2N, 8N, 9N, Jubilee, NAA (Variation of B5002-013, above)	
B5002-012	Ford Light Switch	\$14.75
	Has Knurled Knob just like Original. Has 2 Threaded Spade Terminals With Screws That Can Be Used With Headlights or Tail Lamps. Threaded Stem Measures 3/8-24 UNF. Ford Replaces: #FDN11654A Fits: [2000 4 cylinder, 2031, 2111, 2131, 4000 4 cylinder, 4031, 4110, 4120, 4121, 4140, 501, 541, 601, 611, 621, 631, 641, 651, 661, 671, 681, 701, 741, 771, 801, 811, 821, 841, 851, 861, 871, 881, 901, 941, 951, 961, 971, 981 (1955 thru 1964)], [600, 620, 630, 640, 650, 660, 700, 740, 800, 820, 840, 850, 860, 900, 950, 960 (Serial #10615 & Up)]; Industrial: 1801, 1811, 1821, 1841, 1871, 1881, 2030, 2130, 4030 4 cylinder, 4040, 4130 4 cylinder (1955 thru 1964)	

STARTER SWITCHES & SOLENOIDS

B5007-025	12-Volt Isolated Base Solenoid	\$31.50
	<p>Has a Flat Bracket & 3 Terminal Post. Works with 12 Volt Systems. Isolated base/ isolated ground. Ford Replaces: #NCA11450A, 21A-11450 Fits: 600, 620, 630, 640, 650, 660, 700, 740, 800, 820, 840, 850, 860, 900, 950, 960, 501, 541, 601, 611, 621, 631, 641, 651, 661, 671, 681, 701, 741, 771, 801, 811, 821, 841, 851, 861, 871, 881, 901, 941, 951, 961, 971, 981 with 4 cylinder gas)</p>	

B5007-039	12 Volt Bosch Starter Solenoid	\$33.25
	<p>12 Volt Rated Solenoid for Bosh Starters with 3 Terminals. Has a Crimped Cap & 3 Hole Mount. Additional Mounting Parts Included. Ford Replaces: #F0NN-11390-AA Fits: 3230, 3430, 3930, 4130, 4630, 5030, 5640, 6640, 7740, 7840, 8160, 8240, 8260, 8340, 8360, 8560, 9030 Industrials: 555, 575, 655, 675</p>	

B5006-006	Ford Starter Switch	\$23.50
	<p>Replacement Starter Switch for 9N Serial #12500 & Up, 2N</p>	

B5006-007	Ford Starter Switch	\$26.25
	<p>Replacement Starter Switch for 8N, Golden Jubilee, Jubilee, NAA, NAB, 500-4000 (4 Cylinder Gas with Standard Transmission)</p>	

B5007-012	6-Volt Ford 8N Solenoid	\$17.50
	<p>6 Volt Rated Solenoid with Special Curved Base Mounting Bracket & 3 Terminal Post. Replaces: Delco - #U938 Ford - #8N-11450, SW218, SW355 Fits: Ford - 8N</p>	

B5007-041	12-Volt Ford Solenoid	\$17.50
	<p>12 Volt Rated Solenoid with Special Curved Base Mounting Bracket & 3 Terminal Post. Replaces: (Except that it is 12 Volt) Delco - #U938 Ford - #8N-11450, SW218, SW355 Fits: Ford - 2N, 8N, 9N, NAA, NAB, 500-900 Series <i>Used on tractors with 12 Volt Conversions</i></p>	

B5007-005	6-Volt Isolated Base Solenoid	\$17.75
	<p>Has a Flat Bracket & 3 Terminal Post. Works with 6 Volt Systems. Isolated base/ isolated ground. Replaces: Autolite/ Prestolite - #SW1, SW219 Delco - #DR1494, U925, U928 Ford - #NCA11450A, 21A-11450 Fits: Ford (4-Cylinder Gas, up to 1964) - Golden Jubilee, Jubilee, NAA, NAB, 600, 620, 630, 640, 650, 660, 700, 740, 800, 820, 840, 850, 860, 900, 950, 960, 501, 541, 601, 611, 621, 631, 641, 651, 661, 671, 681, 701, 741, 771, 801, 811, 821, 841, 851, 861, 871, 881, 901, 941, 951, 961, 971, 981</p>	

B5007-009	6-Volt Solenoid with Bakelite Case	\$17.75
	<p>This Solenoid has a Flat Mounting Bracket & is 6 Volts. It has 4 Terminals with a Bakelite Housing & Isolated Base/ Isolated Ground. Replaces: Delco - #1114542, 1111451, 1111460, 1111469, 1972147, F902 Prestolite - #15-159, 15-188, SAW-4606, SAW-4606T, SAW-4608 Ford - #311007, SW217 Fits: Ford - 600, 620, 630, 640, 650, 660, 700, 740, 800, 820, 840, 850, 860, 900, 950, 960, 501, 541, 601, 611, 621, 631, 641, 651, 661, 671, 681, 701, 741, 771, 801, 811, 821, 841, 851, 861, 871, 881, 901, 941, 951, 961, 971, 981, 1801, 1811, 1821, 1841, 1871, 1881, 2000, 2030, 2031, 2110, 2111, 2120, 2130, 2131, 4000, 4030, 4031, 4040, 4120, 4121, 4130, 4131, & 4140</p>	

B5007-052	12-Volt Solenoid with Bakelite Case for Ford Tractors	\$17.75
	<p>Has a Flat Mounting Bracket & is 12 Volts. It has 4 Terminals with a Bakelite Housing. It has 5/16-24 Thread for Battery and Motor Post and a 10-32 Post for the Terminal Switch. Replaces: Prestolite - #15-104 Ford - #311006, SW220 Fits: Ford Tractor- 2000, 2110 (with 3-158 Gas/Diesel Engine), 3000, 3400, 3550, 4000 (with 3-201 Diesel Engine), 4110, 4400, 4410 (with 3/192 Gas Engine 3-201 Diesel), 5000, 6600, 6700, 7000 (Gas or Diesel)</p>	



B5007-018	Lucas M50 12-Volt Starter Solenoid	\$40.75
	<p>12 Volt Rated Solenoid for Lucas M50 Direct Drive Starters. Has 4 Terminals. Replaces: Lucas - #27228A, 76740, 76753, 76756, 76781, 76825, 76833, 76834, 76835, 76836, 76854, 76862, 76864, 76865, 76869, 76881, 76900, 76905, 76910, 76911, 76912, 76913, 76928, 76956, 77010, 77014, 77025, 77032, 77052, 77109, TOB108, TOB110, TOB111, TOB114, TOB129, TOB133, TOB179, TOB184, TOB199 Ford - #D7NN11390B, 2701E11390A Fits: Ford - 2000, 2100, 2110, 2120, 2300, 2310, 2610, 2810, 2910, 3000, 3100, 3110, 3120, 3190, 3230, 3300, 3310, 3330, 3400, 3430, 3500, 3600, 3610, 3900, 3910, 4000, 4100, 41110, 4140, 4200, 4330, 4340, 4400, 4410, 4500, 4600, 4610, 5000, 5100, 5200, 5340, 5600, 5610, 5900, 6600, 6610, 6700, 6710, 7000, 7100, 7200, 7400, 7600, 7610, 7700, 7710, 7810, 7910, 8000, 8210, 8530, 8600, 8700, 8730, 8830, 9000, 9030, 9600, 9700</p>	

CIGARETTE LIGHTERS

B9030-001	6 Volt Cigarette Lighter	\$29.99
	<p>With Anodized Aluminum Knob, "Lighter" Is Engraved Ford Replaces: #8N9004601 Fits: [8N, Jubilee, NAA (For models with a 6 volt system) (mounting bracket not included)</p>	
B9030-002	12 Volt Cigarette Lighter	\$29.99
	<p>Black plastic with 'lighter' in white printing Ford Replaces: #9821310, 84568736, C9NN15A055A, E3NN15760AA, 378781R91, 382671R91, 382672R91, 393699R91 Fits: A64, A66, TW15, TW25, TW35, TW5, 230A, 2310, 234, 250C, 2610, 2810, 2910, 3230, 334, 335, 340B, 3430, 3610, 3910, 3930H, 3930N, 3930NO, 4110 (3 Cyl.), 4130NO, 445A, 450, 4610, 4630NO, 4630O, 4830, 4830N, 4830O, 5030, 5030O, 530A, 540A, 540B, 545A, 8000, 8200, 8210, 8400, 8530, 8600, 8630, 8830, 9000, 9200, 9600</p>	
B9030-003	12 Volt Cigarette Lighter	\$27.99
	<p>The knob is black plastic with the word 'lighter' in white printing. Ford Replaces: #378781R91, 382671R91, 382672R91, 393699R91, 9821310, 84568736, C9NN15A055A, E3NN15760AA Fits: 230A, 234, 250C, 334, 335, 340B, 445A, 450, 530A, 540A, 540B, 545A, 2310, 2610, 2810, 2910, 3230, 3430, 3610, 3910, 3930H, 3930N, 3930NO, 4110 (3 Cyl.), 4130NO, 4610, 4630NO, 4630O, 4830, 4830N, 4830O, 5030, 5030O, 8000, 8200, 8210, 8400, 8530, 8600, 8630, 8830, 9000, 9200, 9600, A64, A66, TW15, TW25, TW35, TW5</p>	

CARBURETOR REBUILD KITS

B9022-033	Holley Carburetor Rebuild Kit	\$39.99
	<p>Ford Tractors 2000 (3-cylinder), 2110, 2120, 2300, 2310, 2600, 2610, 3000, 3100, 3110, 3120, 3150, 3300, 3310, 3330, 3600, 3610, 4000 (3-cylinder), 4100, 4110, 4600, 4610 5000, 5100 Industrial – 230A, 231, 335, 340, 420, 445, 515, 515, 530, 530A, 531, 535, 545, 545, 550, 555A, 555B, 3400, 3500, 4400, 4500, 5500 Replaces: Ford – R3210, R3656A, R3657, R3658, R4111A, R4119A, R4120-1, R6852, R6853, R7867, R7896 Fits: Ford Carburetor: C5NN9510B, C5NN9510D, C5NN9510L, C5NN9510M, C5NN9510N, C5NN9510R, C7NN9510A, C7NN9510B, C7NN9510C, C9NN9510A, C9NN9510C, D3NN9510B, D3NN-C, D8NN9510AA, D8NN9510BA, D8NN9510CA, Holley Carburetor: LIST6852, R3012, R3013-4A, R3158A, R3589B, R3655A, R3656A, R3657A, R3658, R3658-1A, R3658A, R4111, R4111-1A, R4119, R4119-1A, R4120, R4120-1, R4120-1A, R6852-A, R6863, R6863-A, R8552, R8553, R8554</p>	

B9022-020	Marvel-Schebler Carburetor Rebuild Kit	\$35.75
	<p>Ford Tractors Model 2N, 8N, 8NAN, 9N Fits Carburetor: Marvel-Schebler Carburetor: #TSX-33, TSX-241A, TSX-241B, TSX-241C, TSX420 Ford Carburetor: #8N9510, 8NAN9510, 9N-9510-A, ED-8N-9510</p>	
B9022-023	Marvel-Schebler Carburetor Rebuild Kit	\$24.50
	<p>Ford Tractor Model 2N, [600, 600K, 620, 630, 640, 650, 660, 700, 700K, 740, 800, 820, 840, 850, 860, 900, 950, 960 (1954 Thru 1957)], 8N, 9N, Golden Jubilee, Jubilee, NAA, NAB Fits Carburetor: Marvel-Schebler Carburetor: #1004SL, TSX101, TSX102, TSX103, TSX112, TSX113, TSX114, TSX119, TSX120, TSX126, TSX128, TSX13, TSX132, TSX132A, TSX133, TSX134, TSX136, TSX137, TSX138, TSX140, TSX141, TSX142, TSX144, TSX146, TSX147, TSX148, TSX150, TSX151, TSX154, TSX155, TSX156, TSX157, TSX159, TSX161, TSX167, TSX171, TSX173, TSX179, TSX180, TSX182, TSX183, TSX184, TSX186, TSX188, TSX189, TSX190, TSX191, TSX192, TSX193, TSX194, TSX197, TSX198, TSX202, TSX203, TSX206, TSX206-1, TSX211, TSX212, TSX225, TSX228, TSX231, TSX237, TSX239, TSX239-1, TSX240, TSX241A, TSX241B, TSX241C, TSX246, TSX248, TSX253, TSX254, TSX258, TSX260, TSX264, TSX266, TSX267, TSX269, TSX272, TSX274, TSX278, TSX28, TSX280, TSX286, TSX287, TSX288, TSX289, TSX29, TSX290, TSX297, TSX30, TSX301, TSX305, TSX306, TSX308, TSX309, TSX312, TSX314, TSX315, TSX319, TSX322, TSX323, TSX326, TSX328, TSX33, TSX330, TSX331, TSX332, TSX333, TSX334, TSX335, TSX338, TSX339, TSX34, TSX341, TSX346, TSX347, TSX348, TSX35, TSX351, TSX352, TSX356, TSX357, TSX358, TSX359, TSX36, TSX361, TSX361-A, TSX363, TSX366, TSX367, TSX368, TSX37, TSX370, TSX370-1, TSX377, TSX38, TSX380, TSX388, TSX389, TSX39, TSX391, TSX398, TSX400, TSX403, TSX405, TSX406, TSX407, TSX409, TSX418, TSX419, TSX42, TSX420, TSX421, TSX422, TSX423, TSX428, TSX43, TSX44, TSX443, TSX447, TSX448, TSX45, TSX450, TSX452, TSX453, TSX455, TSX458, TSX459, TSX465, TSX470, TSX472, TSX474, TSX48, TSX480, TSX481, TSX484, TSX486, TSX49, TSX497, TSX500, TSX507, TSX510, TSX513, TSX514, TSX516, TSX518, TSX520, TSX525, TSX531, TSX532, TSX534, TSX539, TSX54, TSX541, TSX55, TSX551, TSX552, TSX556, TSX558, TSX560, TSX567, TSX569, TSX570, TSX573, TSX577, TSX58, TSX580, TSX589, TSX59, TSX593, TSX595, TSX597, TSX60, TSX603, TSX605, TSX606, TSX611, TSX614, TSX618, TSX626, TSX633, TSX635, TSX643, TSX646, TSX649, TSX649-1, TSX650, TSX653, TSX655, TSX656, TSX660, TSX663, TSX665, TSX668, TSX670, TSX671, TSX676, TSX680, TSX681, TSX683, TSX69, TSX690, TSX691, TSX692, TSX694, TSX696, TSX701, TSX706, TSX709, TSX710, TSX714, TSX730, TSX736, TSX74, TSX742, TSX744, TSX748, TSX753, TSX76, TSX762, TSX765, TSX767, TSX770, TSX771, TSX776, TSX776-1, TSX78, TSX781, TSX787, TSX79, TSX793, TSX796, TSX80, TSX802, TSX803, TSX804, TSX809, TSX812, TSX815, TSX820, TSX826, TSX827, TSX83, TSX830, TSX841, TSX844, TSX85, TSX851, TSX855, TSX857, TSX860, TSX862, TSX864, TSX865, TSX866, TSX879, TSX88, TSX882, TSX89, TSX896, TSX896SL, TSX90, TSX901, TSX91, TSX912, TSX913, TSX914, TSX919, TSX926, TSX930, TSX931, TSX936, TSX936SL, TSX937, TSX937SL, TSX94, TSX948, TSX949, TSX95, TSX954, TSX957, TSX957SL, TSX95A, TSX96, TSX971, TSX976, TSX978, TSX979, TSX979-1, TSX98, TSX983, TSX986, TSX987, TSX99, TSX990, TSX991, TSX991-1, TSX996, TSXU828, TSXU829, TSXU830, TSXU831, TSXU832, TSXU833, TSXU834, 1003... (continued on next page)</p>	

...**Ford Carburetor:** #2N9510, 302954, 310746, 312778, 312954, 8N9510, 8NAN9510, 9N9510A, D3JL-E, D3JL9510E, EAC-C, EAE9510A, EAE9510D, EAF9510D, EAF9510E, EAF9510G, EBD-8N-9510, EBD9510D, EBD9510D, EBE9510D, EDB9510D

B9022-005 Marvel-Schebler Carburetor Rebuild Kit \$23.99



Ford Tractors Model 800, 801, 811, 821, 841, 851, 861, 871, 881, 900, 901, 941, 951, 961, 971, 981, 1801, 1811, 1821, 1841, 1871, 1881, 4000 (4 Cyl.), 4030 (4 Cyl.), 4031, 4040, 4110, 4120, 4121, 4130 (4 Cyl.), 4131, 4140 (4 Cyl.)

Fits **Marvel-Schebler Carburetor:**

TSX1001, TSX1002, TSX181, TSX221, TSX245, TSX296, TSX332, TSX360, TSX374, TSX397, TSX413, TSX414, TSX436, TSX464, TSX466, TSX475, TSX492, TSX505, TSX506, TSX506A, TSX526, TSX528, TSX530, TSX561, TSX562, TSX563, TSX575, TSX582, TSX592, TSX596, TSX602, TSX605, TSX606, TSX610, TSX615, TSX633, TSX639, TSX641, TSX645, TSX648, TSX662, TSX678, TSX688, TSX689, TSX695, TSX704, TSX711, TSX713, TSX719, TSX721, TSX725, TSX732, TSX737, TSX738, TSX755, TSX756, TSX757, TSX759, TSX768, TSX769, TSX772, TSX773, TSX775, TSX777, TSX784, TSX788, TSX791, TSX792, TSX797, TSX798, TSX799, TSX800, TSX801, TSX806, TSX808, TSX810, TSX811, TSX813, TSX814, TSX816, TSX819, TSX825, TSX836, TSX843, TSX849, TSX853, TSX854, TSX856, TSX857, TSX867, TSX869, TSX871, TSX877, TSX878, TSX881, TSX883, TSX884, TSX885, TSX886, TSX888, TSX889, TSX892, TSX892S, TSX893, TSX894, TSX895, TSX897, TSX898, TSX899, TSX900, TSX902, TSX903, TSX904, TSX904SL, TSX905, TSX905-1, TSX905SL, TSX906, TSX906SL, TSX907, TSX907SL, TSX908, TSX908SL, TSX911, TSX917, TSX920, TSX920SL, TSX921SL, TSX922, TSX922SL, TSX923, TSX923SL, TSX925, TSX927, TSX928, TSX932, TSX932SL, TSX933, TSX934, TSX934SL, TSX938, TSX938SL, TSX939, TSX940, TSX940SL, TSX941, TSX941SL, TSX942, TSX943, TSX944SL, TSX945SL, TSX946, TSX947SL, TSX949, TSX950, TSX952, TSX952SL, TSX955, TSX959, TSX959SL, TSX961, TSX961SL, TSX962, TSX962SL, TSX964SL, TSX965SL, TSX966, TSX967SL, TSX968SL, TSX97, TSX972, TSX973, TSX974, TSX974SL, TSX975, TSX975SL, TSX977, TSX980, TSX980SL, TSX984SL, TSX985, TSX985SL, TSX988, TSX989, TSX993, TSX994, TSX997, TSX998, TSX999, TSXU1006, TSXU1007, TSXU835, TSXU836, TSXU840, TSXU904, TSXU904SL, TSXU905, TSXU905-1, TSXU944SL, TSXU963, TSXU9631, TSXU995

Replaces: **Ford** - 310015, 310015C, 312955, CONN9510C, D1NL-A, D23L-H, D2JL-G, D3JL-D, D3JL9510D, D4JL-3, D5J2-K, D5JL-A, D5JL-B

B9022-004 Marvel-Schebler Carburetor Rebuild Kit \$24.99



Ford Tractors Model 800, 900
Fits Carburetor:

Marvel-Schebler Carburetor: #TSX-662, TSX-769, TSX-813, TSX-966, TSX-967

Ford Carburetor: #310015, CONN-9510-C, D1NL-A, D3JL-D, EAF-312955

B9022-008 Zenith Carburetor Rebuild Kit \$26.95



Ford with Zenith Carburetors
Fits Carburetor:

Zenith Carburetor: #10850, 11294, 12493, 12494, 12544, 12566, 13876, 13877, 13878, 13879, 13880

B9022-011 Zenith Carburetor Rebuild Kit \$24.99



Ford with Zenith Carburetors
Fits Carburetor:

Zenith Carburetor #12902, 12992, 12994, 13875, 13881

CARBURETOR FLOATS

B9023-003 Marvel-Schebler Carburetor Float \$12.75





Ford Tractors Model NAA, 2N, 8N, 8NAN, 9N, 500, 600, 600K, 700, 700K, 800, 900, 2000, 4000 *With 134 Engine*
Replaces Carburetor:

Marvel-Schebler Carburetor: #TSX-33, TSX-241A, B, C, TSX420, TSX-428, TSX-500, TSX551, TSX-577, TSX-551, TSX-580, TSX593, TSX-596, TSX692, TSX706, TSX765, TSX771, TSXU-829, TSXU-834, TSX976

Ford Carburetor: #8N-9510, 8NAN-9510, 9N-9510-A, EAC-C, EAE-9510-D, EAF-9510-D, EBD-8N-9510, EBD-9510-D, ED-8N-9510, EBE-9510-D

Replaces: **Ford:** #9N9550A

B9023-004	Marvel-Schebler Carburetor Float	\$19.95
	<p>Ford Tractors Model 800, 900, 4000 with 172 Engine Replaces Carburetor: Marvel-Schebler Carburetor: #TSX-662, TSX-769, TSX-813, TSX-966, TSX-967, TSX977 Ford Carburetor: #310015, CONN-9510-C, D1NL-A, D3JL-D, EAF-312955 Replaces: Ford: #311608</p>	

B9023-015	Zenith Carburetor Float	\$24.99
	<p>Ford Tractors Model 800, 900, 2000 (3-cylinder), 3000, 4000 (3-cylinder), 5000 Replaces: Zenith: #C85-115, C85-115S Fits Carburetor: (various- see website)</p>	

CARBURETOR ACCESSORIES

B9038-003	Carburetor Elbow Fuel Line Fitting with Strainer	\$7.99
	<p>Elbow Fuel Line Fitting with strainer for IHC carburetors. 1/8" Pipe to 1/4" Flare. Works with Carter UT Series and Various Marvel-Schebler Carburetors. Fits: Ford - 8N, 9N, NAA, Golden Jubilee, Jubilee, 600, 800, 2N, 620, 630, 640, 650, 660, 700, 740, 820, 840, 850, 860, 900, 950, 960, NAB (1939-1957) Replaces: #9N9553</p>	

B9038-007	2" Sediment Bowl Gasket	\$2.19
	<p>2" Outer Diameter, Bowl to Body; Fits a 1.28" Tall Glass Bowl Ford Replaces: NAA9160A Fits: 2N, 8N, 9N, Jubilee, NAA</p>	

FUEL SEDIMENT BOWLS

B9036-003	Fuel Sediment Bowl	\$20.75
	<p>Has a 3/8" Pipe Inlet and a 1/4" Pipe Outlet. (Includes Sediment Bowl Screen) Ford Replaces: #2N9155B, NAA9155B Fits: 8N, 9N, NAA, Golden Jubilee, Jubilee, 2N (1939-1954)</p>	

B9038-011	Sediment Bowl Screen	\$2.75
	<p>1 3/4" Diameter, Square Hole Screen, Silicon Bronze Alloy, Fits B9036-003 above</p>	

B9038-013	Sediment Bowl Screen and Gasket Kit	\$3.25
	<p>Includes 1 Screen and 1 Gasket Ford Replaces: 2N9161, 2NAA916061, NAA9160A Fits: 2N, 600, 700, 800, 8N, 900, 9N, Jubilee, NAA</p>	

B9036-007	Fuel Sediment Bowl	\$29.95
	<p>3/8" Bolt Hole, 1/4" Fuel Line Thread, Includes Glass Bowl Ford Replaces: #NCA9155D Fits: (with 134 cubic inch gas & using 1/4" fuel line thread & 3/8" mounting bolt hole) (1954-57, up to Serial #126,524) – 600, 620, 630, 640, 650, 660, 740, 800, 820, 840, 850, 860, 900, 940, 950, 960 (1954-64) – 501, 541, 601, 611, 621, 631, 641, 651, 661, 671, 681, 700, 701, 741, 2000 (4-cylinder), 2031, 2111, 2120 (4-cylinder), 2121, 2131 (Industrial) – 2030, 2130</p>	

B9038-014	Fuel Filter Screen & Gasket Set, 1 9/16" Diameter	\$4.99
	<p>Includes 1 Screen and 1 Gasket Dimensions: 1 3/8" screen outside diameter 1 9/16" gasket outside diameter Ford Fits (1954-1964): 501, 541, 600, 601, 611, 620, 621, 630, 631, 640, 641, 650, 651, 660, 661, 671, 681, 700, 701, 740, 741, 771, 800, 801, 811, 820, 821, 840, 841, 850, 851, 860, 861, 871, 881, 900, 901, 940, 941, 950, 951, 960, 961, 971, 981, 2000 (4-cylinder), 2031, 2110, 2111, 2120, 2131, 4000 (4-cylinder), 4031, 4110, 4120, 4121, 4140 (1961-1967): 6000</p>	

FUEL SYSTEM ACCESSORIES

B9038-009	Fuel Cap	\$10.99
	Chrome Plated, 2.7" Outside Diameter, 1.88" Overall Tab Length, .25" Tab Width Ford Replaces: C5NN9030B, C5NN9030D, E7NN9030AA Fits: 2N, 8N, 9N, 501, 515, 531, 532, 535, 540, 541, 545, 550, 555, 600, 601, 611, 620, 621, 630, 631, 640, 641, 650, 651, 655, 660, 661, 671, 681, 700, 701, 740, 741, 750, 755, 771, 800, 801, 811, 820, 821, 840, 841, 850, 851, 860, 861, 871, 881, 900, 901, 941, 950, 951, 960, 961, 971, 981, 2000 (3-cylinder), 2000 (4-cylinder), 2031, 2100, 2110, 2111, 2120, 2131, 2150, 2300, 2310, 2600, 2610, 2810, 2910, 3000, 3055, 3100, 3110, 3120, 3150, 3190, 3300, 3310, 3330, 3600, 3600V, 3610, 3900, 3910, 3930, 4000 (3-cylinder), 4000 (4-cylinder), 4030 (3-cylinder), 4031, 4100, 4110, 4121, 4130 (3-cylinder), 4131, 4140, 4190, 4200, 4330, 4340, 4410, 4600, 4600SU, 4610, 5000, 5100, 5200, 5340, 5600, 5610, 5700, 5900, 6000, 6600, 6610, 6700, 7000, 7100, 7200, 7600, 7610, 8000, 9000, Jubilee, NAA	

B9038-016	Ford Fuel Shut Off Valve	\$34.95
	Includes O-Ring at Fuel Tank, Fits 1/4" threaded line Ford Replaces: #311292, NCA9285B Fits: (Gas, Diesel, 1954-1964): 501, 541, 600, 601, 611, 620, 621, 630, 631, 640, 641, 650, 651, 660, 661, 700, 701, 740, 741, 771, 2000 (4-cylinder), 2031, 2110, 2111, 2120, 2131 (Gas, Diesel to SN# 126524 w/ 1/4" Fuel Line): 800, 801, 811, 820, 821, 840, 841, 850, 851, 860, 861, 871, 881, 900, 901, 941, 950, 951, 960, 961, 971, 981 (Gas, Diesel 1962-1964): 2030, 2130 (Diesel models only, 1962-1964): 1801, 1811, 1821, 1841, 1871, 1881, 4000 (4-cylinder), 4030 (4-cylinder), 4040, 4031, 4110, 4120, 4121, 4130 (4-cylinder), 4131, 4140	

FUEL SENDING UNITS

B9037-006	Fuel Sending Unit	\$29.99
	14-122 Ohms. Measures 5 1/2" long. Fits Gas & Diesel. Works with B9025-049, not with OEM fuel gauges. Ford Replaces: 310938, 310939 Fits: 501, 541, 601, 611, 621, 631, 641, 651, 661, 671, 681, 701, 741, 771, 2000 4 cylinder, 2030, 2031, 2110, 2111, 2120, 2130, 2131	

B9037-003	Fuel Sending Unit	\$29.99
	8 3/4" long. 14 - 122 Ohm Range Ford Replaces: 310940, 310941 Fits (4-cylinder gas, diesel; 1958 - 1964): 801, 811, 821, 841, 850, 851, 861, 871, 881, 901, 941, 951, 961, 971, 981, 4000 (4-cylinder), 4031, 4110, 4120, 4121, 4131, 4140	

GIBSON

SPARK PLUG WIRE SETS

Our Spark Plug Wire Sets Come Fully Assembled with the Proper Type Wire & Terminals. They are Custom Tailored to Look & Fit Like Original Factory Equipment.



Gibson I With Hercules QXD5 Engine

6 Cyl. Tailored Spark Plug Wire Set

B1017-001	Original Type Cotton Braid Wire	\$35.75
B1017-001E	EPDM Wire	\$39.25

LIGHTS & LIGHT PARTS

B9016-003	Flat Lens Type Head Lamp	\$99.99
	6 Volt Head, & clear rear lamp (can be used as 12 volt by Changing bulb) Gibson Fits: I	

PARTS FOR LIGHT ABOVE

Headlamp & Parts are interchangeable with original except as noted.

B9017-002	7" Lens With Guide Name	\$21.99
B9017-003	7" Clamp Ring	\$17.99
B9017-005	7" Gasket	\$8.99
B9017-006	7" Reflector *Call for Availability*	\$16.50
B9017-067	7" Light Terminal	\$6.00
B9017-013	6 Volt Bulb <i>Fits Above Reflector, Not Original</i>	\$3.00
	Pack of 10	\$25.50
B9017-015	12 Volt Bulb <i>Fits Above Reflector, Not Original</i>	\$3.00
	Pack of 10	\$25.50

Did You Know?

The original Gibson tractor slogan was "Master of 1000 Chores".

GRAHAM BRADLEY

SPARK PLUG WIRE SETS

Our Spark Plug Wire Sets Come Fully Assembled with the Proper Type Wire & Terminals.

They are Custom Tailored to Look & Fit Like Original Factory Equipment.

Varieties include:

Cotton Braid Wire: Copper Core with a Cotton Jacket.

EPDM Wire (E): Hi Performance Premium Conductor with a Tinned Copper Core, EPDM Silicone Insulation, and a Rubber Jacket.

Suppression Wire (S): for Electronic Ignition and is Spiral Wound, Ultra Low-Ohm, with EPDM Silicone Insulation and a Rubber Jacket.

Cotton Braid Suppression Wire (CS): also for Electronic Ignition, as Suppression Wire, but has an additional layer of Cotton Braid & Lacquer to replicate the vintage look, as well.



Graham Bradley with Continental F218 Engine
6 Cyl. Tailored Spark Plug Wire Set

B1018-001	Original Type Cotton Braid Wire	\$35.75
B1018-001E	EPDM Wire	\$39.25
B1018-001S	Suppression Wire	\$39.25
B1018-001CS	Cotton Suppression Wire	\$62.00

BATTERY CABLES







Our Battery Cables are made from the Proper Gauge Copper, as either Black Cotton Braided Wire or PVC Wire (whichever is correct for the application), using Soldered & Heat Sealed Brass or Copper Terminals.

Graham Bradley with Continental F120 Engine

B2018-001	Positive Battery Cable	\$43.00
B2000-006	Negative Ground Strap	\$13.50

TUNE UP PARTS

Graham Bradley 6 Cylinder 1937-1939 (with Delco #1110502, 1110503 Distributors)

	B4001-021	\$13.75
	Points Replaces: #1855520, D-109	
	B4002-001	\$4.75
	Condenser Replaces: #1928111, D-203, 1869704, D-200	
	B4004-021	\$14.75
	Rotor Replaces: #816774	
	B4003-059	\$22.50
	Cap Replaces: #816779, 822465, 1831800, 1853240	



***For Ignition Coils & Accessories, see p.44**

ELECTRONIC IGNITION CONVERSION KITS

Replaces Points & Condenser



Graham Bradley 6 Cylinder 1937-1939
with Delco #1110502, 1110503 Distributors

B9600-309	12 Volt Negative Ground	\$154.95
B9600-309P6	6 Volt Positive Ground	\$169.45



GAUGES

Ammeters, Universal

B9025-002	Ammeter 20-0-20	\$19.99
	Has a black face with white lettering and a chrome bezel Does not have a logo Dimensions: Fits in 2" Diameter Hole 1.850" From Post to Bottom of Bezel	
B9025-005	Ammeter 30-0-30	\$19.99
	Has a black face with white lettering and a chrome bezel. Dimensions: Fits in a 2" Diameter Hole 1.740" From Top of Post to Bottom of Bezel	
B9025-008	Ammeter 60-0-60	\$19.99
	Has a black face with white lettering & a chrome bezel Uses threaded terminals and is dash mounted Used with 12-Volt Alternator Systems Dimensions: Fits in 2" Diameter Hole Measures 1.765" from Top of Post to Bottom of Bezel	

SWITCHES

Push/Pull Switches

B5002-001	2 Position Push/Pull Switch	\$7.75
	OFF/ON Universal 2-Position Push/Pull 2 Screw Terminals Mounting Stem 3/8"-32 Thread Knob #10/32 Thread	
B5002-005	3-Position Push/ Pull Switch	\$29.75
	Low Charge/High Charge/Lights 3-Position Switch 3 Screw Type Mounting Stem .8" Thread Knob #10/32 Thread Premium Quality Made by the OEM Manufacturer	

B5002-004	Heavy Duty Push/Pull Magneto Switch	\$8.25
	ON/OFF 2-Position Push/Pull Magneto Switch 2 Screw Terminals Mounting Stem 3/8"-32 Thread Knob #10/32 Thread	

Key Switches

B5003-001	2 Position Battery Key Switch	\$14.75
	Universal OFF/ON 2-Position Key Switch (For Battery Ignition) 2 Screw Terminals Mounting Stem 3/4"-20 Thread	

ALTERNATORS

Delco 10SI Type



B6001-001	12 Volt Alternator (1 Wire)	\$112.75
63 Amp, Low Cut In, Specially Built For Tractors, Forklifts, & Other Low Engine Speed Applications		
B6001-005	6 Volt Alternator (1 Wire, Positive Ground)	\$166.50
6 Volt, 40 Amp Alternator with Positive Ground, 1 Wire, 3/8" pulley		

Small ND Type

B6002-003	12 Volt Small Denso Alternator (1-Wire)	\$119.75
	40 Amp, 1 Wire Internal Regulator. Will Start Charging with a Much Lower Engine Speed. Comes with a 4 1/2" Housing Diameter, 3/8 To 1/2" Belt width & a 2 1/2" Pulley Diameter. Excellent for Converting a 6 Volt System to 12 Volt. Negative Ground Only & is Self-Excited	

GRAVELY

SPARK PLUG WIRE SETS

Gravely Model L

1 Cyl. Tailored Spark Plug Wire Set

B1019-001	Original Type Cotton Braid Wire	\$8.00
B1019-001E	EPDM Wire	\$9.00

TUNE UP PARTS

Gravely Model L

with WICO Magneto #XH1072, XH2049, XH2533

	B4011-004 Points Replaces: #1-5008, 1-5111, FXH-2100B, FXH-2400B, X5996	\$17.75
	B4012-002 Condenser Replaces: #2-5007, X5614, X6916	\$13.75
	B4017-040 Condenser Clamp Replaces: #94-5167	\$2.75
	B4013-005 Cap Replaces: #94-5212, FXH-2312A-2	\$39.50
	B4016-004 Cap Gasket Replaces: #94-5076	\$2.25
	B4015-003 Coil (Hot Coil) Replaces: #5-5011, AR12006, FXH2403, X5700, X5700B, X5700C	\$39.75
	B4017-003 Coil Clamp 2 used, each sold separately Replaces: #94-5080	\$2.25
	B4017-004 Coil Bar Replaces: #94-5066	\$8.50
	B4017-005 Inner Bearing Replaces: #24-5000	\$3.50
	B4017-006 Outer Bearing Replaces: #25-5000	\$9.75
	B4017-046 Bearing Cage Snap Ring Replaces: #43-5055	\$2.75

	B4017-008 Stop Button Assembly Includes #B4017-009 Replaces: #90-5042 For the version with a Ground Wire, use #B4017-063 (\$7.26) instead.	\$6.25
	B4017-009 Stop Button Replaces: #94-5079	\$2.25
	B4017-007 Impulse Spring Replaces: #94-5016	\$12.50
	B4017-051 WICO Impulse Catch Plate Replaces: #94-5070, FXH-210S-1	\$10.25
	B4016-005 Flange Gasket Replaces: #SAE	\$1.75
	B4016-012 Striker Plate Gasket Replaces: #94-5154	\$2.25
	B4016-015 Impulse Assembly Gasket Replaces: #94-5075	\$2.25
	B9013-011 WICO Series X Nameplate Fits the WICO Series X magneto (Rivets included)	\$7.00

CARBURETOR REBUILD KITS

B9022-008	Zenith Carburetor Rebuild Kit	\$26.95
	Gravely Model D, L, Super L Fits Zenith Carburetor: #9572, 9995, 9995A, 9995B, 11465, 12108, 12522, 12544, 13007, 13246, 14544 Gravely Carburetor: #8228, 1712-Z, 10878-P1	

STARTER SWITCHES

B5006-001	Mechanical Starter Switch (Long Shaft)	\$12.75
	6 or 12 Volt Panel Mounted Manual Push Replaces: Delco - #192119, D900, 450C Prestolite - #15-121, 15-122, 15-409, 15-45, 15-47, 15-50, 15-51, SW-2916, SW-4001, SW-4002, SW-4005, SW-4010, SW-4013, SW-4015, SW-4017, SW-4101, SWX-47 Fits: Gravely - Model L	

GRAY MARINE ENGINES

SPARK PLUG WIRE SETS

Our Spark Plug Wire Sets Come Fully Assembled with the Proper Type Wire & Terminals.

They are Custom Tailored to Look & Fit Like Original Factory Equipment.

Varieties include:

Cotton Braid Wire: Copper Core with a Cotton Jacket.

PVC Wire: Copper Core with a Rubber Jacket.

EPDM Wire (E): Hi Performance Premium Conductor with a Tinned Copper Core, EPDM Silicone Insulation, and a Rubber Jacket.

Suppression Wire (S): for Electronic Ignition and is Spiral Wound, Ultra Low-Ohm, with EPDM Silicone Insulation and a Rubber Jacket.



Gray Marine Engine 140HP Flat Head Six

6 Cyl. Tailored Spark Plug Wire Set

B1020-001	Original Type EPDM Wire	\$25.50
------------------	--------------------------------	----------------

1954 Gray Marine Engine 330 CI

6 Cyl. Tailored Spark Plug Wire Set

B1020-002	Original Type EPDM Wire	\$51.00
B1020-002S	Suppression Wire	\$51.00

HART PARR

SPARK PLUG WIRE SETS

Hart Parr I

2 Cyl. Tailored Spark Plug Wire Set

B1021-001	Original Type Cotton Braid Wire	\$28.75
B1021-001E	EPDM Wire	\$31.25

Hart Parr 18-27

4 Cyl. Tailored Spark Plug Wire Set

B1021-004	Original Type Cotton Braid Wire	\$40.25
B1021-004E	EPDM Wire	\$43.75

Hart Parr 28-50

4 Cyl. Tailored Spark Plug Wire Set

B1021-002	Original Type Cotton Braid Wire	\$40.25
B1021-002E	EPDM Wire	\$43.75

Hart Parr 30

2 Cyl. Tailored Spark Plug Wire Set

B1021-005	Original Type Cotton Braid Wire	\$28.75
B1021-005E	EPDM Wire	\$31.25

Hart Parr 70

6 Cyl. Tailored Spark Plug Wire Set

B1021-003	Original Type Cotton Braid Wire	\$51.00
B1021-003E	EPDM Wire	\$55.75

BATTERY CABLES



Hart Parr 70

B2000-002	Positive Ground Strap	\$9.50
B2021-001	Negative Battery Cable	\$20.00
B2021-002	Switch to Starter Cable	\$35.00

HERCULES ENGINES

SPARK PLUG WIRE SETS

Hercules G2300 Engine with Magneto

4 Cyl. Tailored Spark Plug Wire Set

B1022-015	Original Type EPDM Wire	\$48.00
------------------	-------------------------	----------------

Hercules G3400 Engine

6 Cyl. Tailored Spark Plug Wire Set

B1022-012	Original Type EPDM Wire	\$51.25
------------------	-------------------------	----------------

Hercules IXA Engine with WICO C Magneto

4 Cyl. Tailored Spark Plug Wire Set

B1022-001	Original Type Cotton Braid Wire	\$27.25
------------------	---------------------------------	----------------

B1022-001E	EPDM Wire	\$29.75
-------------------	-----------	----------------

Hercules IXA5 Engine with WICO C Magneto

4 Cyl. Tailored Spark Plug Wire Set

B1022-016	Original Type Cotton Braid Wire	\$34.00
------------------	---------------------------------	----------------

Hercules IXB Engine

4 Cyl. Tailored Spark Plug Wire Set

B1022-002	Original Type Cotton Braid Wire	\$20.25
------------------	---------------------------------	----------------

B1022-002E	EPDM Wire	\$22.00
-------------------	-----------	----------------

Hercules IXB3 Engine with Distributor

4 Cyl. Tailored Spark Plug Wire Set

B1022-003	Original Type Cotton Braid Wire	\$20.25
------------------	---------------------------------	----------------

B1022-003E	EPDM Wire	\$22.00
-------------------	-----------	----------------

B1022-003S	Suppression Wire	\$22.00
-------------------	------------------	----------------

Hercules IXB5 Engine

4 Cyl. Tailored Spark Plug Wire Set

B1022-004	Original Type Cotton Braid Wire	\$20.25
------------------	---------------------------------	----------------

B1022-004E	EPDM Wire	\$22.00
-------------------	-----------	----------------

Hercules IXK3 Engine

4 Cyl. Tailored Spark Plug Wire Set

B1022-013	Original Type Cotton Braid Wire	\$22.75
------------------	---------------------------------	----------------

B1022-013E	EPDM Wire	\$24.50
-------------------	-----------	----------------

Hercules JXA, JXB, JXC Engines

6 Cyl. Tailored Spark Plug Wire Set

B1022-005	Original Type Cotton Braid Wire	\$35.75
------------------	---------------------------------	----------------

B1022-005E	EPDM Wire	\$39.25
-------------------	-----------	----------------

B1022-005S	Suppression Wire	\$39.25
-------------------	------------------	----------------

B1022-005CS	Cotton Suppression Wire	\$62.00
--------------------	-------------------------	----------------

Hercules JXEF Engine

6 Cyl. Tailored Spark Plug Wire Set

B1022-008	Original Type Cotton Braid Wire	\$28.25
------------------	---------------------------------	----------------

B1022-008E	EPDM Wire	\$30.75
-------------------	-----------	----------------

Hercules KL Engine

6 Cyl. Tailored Spark Plug Wire Set

B1022-014	Original Type PVC Wire	\$40.00
------------------	------------------------	----------------

B1022-014E	EPDM Wire	\$48.00
-------------------	-----------	----------------

Hercules QXD-3 Engine

6 Cyl. Tailored Spark Plug Wire Set

B1022-009	Original Type Cotton Braid Wire	\$35.25
------------------	---------------------------------	----------------

B1022-009E	EPDM Wire	\$38.50
-------------------	-----------	----------------

Hercules QXLD-3 Engine

6 Cyl. Tailored Spark Plug Wire Set

B1022-010	Original Type Cotton Braid Wire	\$35.25
------------------	---------------------------------	----------------

B1022-010E	EPDM Wire	\$38.50
-------------------	-----------	----------------

Hercules ZXB3 Engine

4 Cyl. Tailored Spark Plug Wire Set



B1022-011	Original Type Cotton Braid Wire	\$27.25
------------------	---------------------------------	----------------

B1022-011E	EPDM Wire	\$29.75
-------------------	-----------	----------------

TUNE UP PARTS FOR MAGNETO IGNITION

Hercules with Fairbanks-Morse Magnetos

#FM-OR6A, FM-R6A, MF-XOR6B, FM-XR6A, FM-XR6B, FM-Z6A, FM-Z6B

	B4014-017	\$36.50
	Rotor Replaces: #Z2765	
	B4013-036	\$87.50
	Cap Replaces: #Q800 Includes Cap Brush	

Did You Know?

During World War II, the Hercules Engine Company produced about 750,000 gasoline and diesel engines for allied military vehicles and ships.

HOUGH

SPARK PLUG WIRE SETS

Our Spark Plug Wire Sets Come Fully Assembled with the Proper Type Wire & Terminals.

They are Custom Tailored to Look & Fit Like Original Factory Equipment.

Varieties include:

PVC Wire: Copper Core with a Rubber Jacket.

EPDM Wire (E): Hi Performance Premium Conductor with a Tinned Copper Core, EPDM Silicone Insulation, and a Rubber Jacket.

Suppression Wire (S): for Electronic Ignition and is Spiral Wound, Ultra Low-Ohm, with EPDM Silicone Insulation and a Rubber Jacket.



Hough PayLoader Model H50G

with IH U264 Gas Engine

6 Cyl. Tailored Spark Plug Wire Set

B1096-001	Original Type PVC Wire	\$34.75
B1096-001E	EPDM Wire	\$42.00
B1096-001S	Suppression Wire	\$42.00

Hough PayLoader Model H65G

with IHG372 Gas Engine

6 Cyl. Tailored Spark Plug Wire Set

B1096-002	Original Type PVC Wire	\$34.75
B1096-002E	EPDM Wire	\$42.00
B1096-002S	Suppression Wire	\$42.00

TUNE UP PARTS FOR BATTERY IGNITION

6 Cyl. Hough Pay Loader Model H50G

with IHC U264 Gas Motor

	B4100-002	\$10.50
	PCR Kit Includes: Points (#B4001-001), Condenser (#B4002-003), Rotor (#B4004-002) Replaces: Points - #D100HP, 1855720 Condenser - #1928111, D203 Rotor - #820445, D400	
	B4004-002	\$5.75
	Rotor Replaces: #820445, D400	

	B4003-002	\$20.25
	Distributor Cap Premium Grade, Made in the USA (Brass Contacts) Replaces: #824735, D301	
	B4006-001	\$9.99
	Dust Cover Replaces: #1900119	
	B4007-001	\$11.95
	Cap Clip Short Mount, 1 Used Replaces: #1889967, 1847289, 453844, 453461	
	B4007-002	\$11.95
	Cap Clip Long Mount, 1 Used Replaces: #1889967, 1889999, 453844, 453461	
	B4008-001	\$14.99
	Distributor Insulator Replaces: #1904376	
	B4009-001	\$25.99
	Distributor Bushing & Shim Kit	



***For Ignition Coils & Accessories, see p.44**

VOLTAGE REGULATORS

Note: Due to modern battery design, voltage regulators can't be used to charge low or dead batteries. Doing so will destroy the voltage regulator and void the warranty.

B8002-038	24-Volt Delco Voltage Regulator	\$119.75
	24 Volt, 4 Terminal, Flat Mounting Replaces: Delco - #1118737, 1118799, 1119185 Fits: Hough - All w/ Delco Generator #1106053 Premium Quality, Made in the USA	

HUBER

SPARK PLUG WIRE SETS

Our Spark Plug Wire Sets Come Fully Assembled with the Proper Type Wire & Terminals.

They are Custom Tailored to Look & Fit Like Original Factory Equipment.

Varieties include:

Cotton Braid Wire: Copper Core with a Cotton Jacket.

EPDM Wire (E): Hi Performance Premium Conductor with a Tinned Copper Core, EPDM Silicone Insulation, and a Rubber Jacket.



Huber Model 20-36

4 Cyl. Tailored Spark Plug Wire Set

B1023-001	Original Type Cotton Braid Wire	\$22.75
B1023-001E	EPDM Wire	\$24.50

Huber Model L, LC

4 Cyl. Tailored Spark Plug Wire Set

B1023-002	Original Type Cotton Braid Wire	\$22.75
B1023-002E	EPDM Wire	\$24.50





Huber Model S

4 Cyl. Tailored Spark Plug Wire Set

B1023-004	Original Type Cotton Braid Wire	\$22.75
B1023-004E	EPDM Wire	\$24.50



TUNE UP PARTS

Huber 4 Cylinder, Model B with Delco Distributor #629N

	B4001-021	\$13.75
Points Replaces: #1855520, D-109		
	B4002-001	\$4.75
Condenser Replaces: #1928111, D-203, 1869704, D-200		
	B4004-021	\$14.75
Rotor Replaces: #816774		
	B4003-033	\$25.50
Cap Replaces: #811589, 1835536, 821589, 818425		

*For 6-Volt Coils & Accessories, see p.44

GAUGES

B9025-002	Ammeter 20-0-20	\$19.99
	Has a black face with white lettering and a chrome bezel Does not have a logo Dimensions: Fits in 2" Diameter Hole 1.850" From Post to Bottom of Bezel	
B9025-008	Ammeter 60-0-60	\$19.99
	Has a black face, white lettering, chrome bezel. Uses threaded terminals, dash mounted Used with 12-Volt Alternator Systems Dimensions: Fits in 2" Diameter Hole Measures 1.765" from Top of Post to Bottom of Bezel	

SWITCHES

B5002-001	2 Position Push/Pull Switch	\$7.75
	OFF/ON Universal 2 Position Push/Pull (2 Screw Terminals) Mounting Stem 3/8"-32 Thread Knob #10/32 Thread	
B5002-005	3-Position Push/ Pull Switch	\$29.75
	Low Charge/High Charge/Lights (3 Position Switch) 3 Screw Type Mounting Stem .8" Thread Knob #10/32 Thread Premium Quality Made by the OEM Manufacturer	
B5002-004	Heavy Duty Push/Pull Magneto Switch	\$8.25
	ON/OFF (2 Position) Push/Pull Magneto Switch (2 Screw Terminals) Mounting Stem 3/8"-32 Thread Knob #10/32 Thread	
B5003-001	2 Position Battery Key Switch	\$14.75
	Universal OFF/ON 2 Position Key Switch (For Battery Ignition) (2 Screw Terminals) Mounting Stem 3/4"-20 Thread	

ALTERNATORS

B6001-001	12 Volt Alternator (1 Wire)	\$112.75
B6001-005	6 Volt Alternator (1 Wire, Positive Ground)	\$166.50
B6002-003	12 Volt Small Denso Alternator (1 Wire)	\$119.75

IHC / FARMALL & MCCORMICK-DEERING TRACTORS

TABLE OF CONTENTS

Spark Plug Wire Sets	152
Battery Cables	155
Wire Harnesses	159
Wiring Harness Clips	183
Replacement Distributors	183
Tune Up Parts for Battery Ignition	184
Box Grommets, Lock Bolts,	188
Junction Blocks	188
Electronic Ignition Conversion Kits	189
Tune Up Parts for Magneto Ignition	189
Magnetos	194
Magneto to Distributor Conversion Kits	195
Cutout Relays & Voltage Regulators	195
Generator Bearing & Brush Sets	196
Identification Tags	196
Alternators	197
Alternator Brackets	197
Alternator Conversion Kits	198
Generator Pulleys, Gauges	198
Tachometer Drive Cables	202
Fuel Sending Units	203
Switches	203
Lights & Light Parts	207
Flashers	210
Starters	210
Starter Parts/ Starter Switches	210
Solenoids	211
Starter Brush Sets & Starter Bearings	212
Auxiliary Plugs & Sockets	213
Cigarette Lighters/ Carburetor Rebuild Kits	213
Carburetor Floats	215
Fuel Sediment Bowls/ Fuel System Accessories	217

IHC 8-16 Titan

2 Cyl. Tailored Spark Plug Wire Set

B1024-001	Original Type Cotton Braid Wire	\$47.50
------------------	--	----------------

IHC 10-20 Titan

2 Cyl. Tailored Spark Plug Wire Set

B1024-092	Original Type Cotton Braid Wire	\$47.50
------------------	--	----------------

IHC 8-16 Junior

4 Cyl. Tailored Spark Plug Wire Set

Early, with Plugs On Top of Engine

B1024-002	Original Type Cotton Braid Wire	\$31.75
------------------	--	----------------

Late, with Plugs On Side of Engine

B1024-003	Original Type Cotton Braid Wire	\$31.75
------------------	--	----------------

IHC 15-30 Titan

4 Cyl. Tailored Spark Plug Wire Set

B1024-004	Original Type Cotton Braid Wire	\$35.25
------------------	--	----------------

McCormick Deering 10-20

with E4A Magneto

4 Cyl. Tailored Spark Plug Wire Set

B1024-005	Original Type Cotton Braid Wire	\$26.75
------------------	--	----------------

B1024-005E	EPDM Wire	\$29.25
-------------------	------------------	----------------

McCormick Deering 15-30

with E4A Magneto

4 Cyl. Tailored Spark Plug Wire Set

B1024-006	Original Type Cotton Braid Wire	\$26.75
------------------	--	----------------

B1024-006E	EPDM Wire	\$29.25
-------------------	------------------	----------------

McCormick Deering 22-36

with E4A Magneto

4 Cyl. Tailored Spark Plug Wire Set

B1024-007	Original Type Cotton Braid Wire	\$26.75
------------------	--	----------------

B1024-007E	EPDM Wire	\$29.25
-------------------	------------------	----------------

Farmall Regular

with E4A Magneto

4 Cyl. Tailored Spark Plug Wire Set

B1024-008	Original Type Cotton Braid Wire	\$26.75
------------------	--	----------------

B1024-008E	EPDM Wire	\$29.25
-------------------	------------------	----------------

Farmall F-12

with Waukesha Engine & E4A Magneto

4 Cyl. Tailored Spark Plug Wire Set

B1024-091	Original Type Cotton Braid Wire	\$26.25
------------------	--	----------------

B1024-091E	EPDM Wire	\$28.75
-------------------	------------------	----------------

Farmall F-12, I-12, O-12, W-12, & F-14

with IH/Farmall Engine

4 Cyl. Tailored Spark Plug Wire Set

B1024-009	Original Type Cotton Braid Wire	\$26.25
------------------	--	----------------

B1024-009E	EPDM Wire	\$28.75
-------------------	------------------	----------------

SPARK PLUG WIRE SETS

Our Spark Plug Wire Sets Come Fully Assembled with the Proper Type Wire & Terminals.

They are Custom Tailored to Look & Fit Like Original Factory Equipment.

Varieties include:

Cotton Braid Wire: Copper Core with a Cotton Jacket.

PVC Wire: Copper Core with a Rubber Jacket.

EPDM Wire (E): Hi Performance Premium Conductor with a Tinned Copper Core, EPDM Silicone Insulation, and a Rubber Jacket.

Suppression Wire (S): for Electronic Ignition and is Spiral Wound, Ultra Low-Ohm, with EPDM Silicone Insulation and a Rubber Jacket.

Cotton Braid Suppression Wire (CS): also for Electronic Ignition, as Suppression Wire, but has an additional layer of Cotton Braid & Lacquer to replicate the vintage look, as well.



Farmall F-20, McCormick Deering T-20

with F4 Magneto
4 Cyl. Tailored Spark Plug Wire Set

B1024-011	Original Type Cotton Braid Wire	\$23.75
B1024-011E	EPDM Wire	\$26.00

Farmall F-30, I-30, W-30

with F4 Magneto
4 Cyl. Tailored Spark Plug Wire Set

B1024-013	Original Type Cotton Braid Wire	\$23.75
B1024-013E	EPDM Wire	\$26.00

Farmall Cub (Up To Serial #224,400)
& Farmall Cub LoBoy (Up To Serial #18,700)

Replaces: #351621R91, 352946R91, & 356697R92 Ignition Cable Set, & 49125D, & 356686R92 Cable, Secondary Coil to Distributor
4 Cyl. Tailored Spark Plug Wire Set

B1024-016	Original Type Cotton Braid Wire	\$23.75
B1024-016E	EPDM Wire	\$26.00
B1024-016S	Suppression Wire	\$26.00

Farmall Cub (Serial #224,401 & Up)
& Farmall Cub LoBoy (Serial #18,701 & Up)

Replaces: #70217C91, 407487R1 Ignition Cable Set, 373167R91 Cable, Secondary Coil to Distributor
4 Cyl. Tailored Spark Plug Wire Set

B1024-055	Original Type PVC Wire	\$23.75
B1024-055E	EPDM Wire	\$26.00
B1024-055S	Suppression Wire	\$26.00

Farmall Cub LoBoy 154, 184, 185

4 Cyl. Tailored Spark Plug Wire Set

B1026-002	Original Type PVC Wire	\$23.75
B1026-002E	EPDM Wire	\$26.00
B1026-002S	Suppression Wire	\$26.00

Farmall A, Super A, B, BN, C, & Super C

4 Cyl. Tailored Spark Plug Wire Set

B1024-017	Original Type Cotton Braid Wire	\$23.75
B1024-017E	EPDM Wire	\$26.00
B1024-017S	Suppression Wire	\$26.00
B1024-017CS	Cotton Suppression Wire	\$40.75

IHC/Farmall H, Super H, I-4, O-4, T-4, W-4, 300, 330, 340, 350

with Horizontal Distributor (or Magneto w/ copper wire)
4 Cyl. Tailored Spark Plug Wire Set

B1024-023	Original Type Cotton Braid Wire	\$23.75
B1024-023E	EPDM Wire	\$26.00
B1024-023S	Suppression Wire	\$26.00
B1024-023CS	Cotton Suppression Wire	\$40.75

IHC/Farmall H, Super H, I-4, O-4, T-4, W-4, 300, 330, 340, & 350

with Replacement Vertical Delco Distributor
4 Cyl. Tailored Spark Plug Wire Set

B1024-093	Original Type Cotton Braid Wire	\$23.75
B1024-093E	EPDM Wire	\$26.00
B1024-093S	Suppression Wire	\$26.00
B1024-093CS	Cotton Suppression Wire	\$40.75

IHC/Farmall I-6, M, Super M, O-6, Super O-6, T-6, W-6, Super W-6, 400 Gas, W400, & 450

with Horizontal Distributor (or Magneto w/ copper wire)
4 Cyl. Tailored Spark Plug Wire Set

B1024-028	Original Type Cotton Braid Wire	\$23.75
B1024-028E	EPDM Wire	\$26.00
B1024-028S	Suppression Wire	\$26.00
B1024-028CS	Cotton Suppression Wire	\$40.75

IHC/Farmall I-6, M, Super M, O6, Super O-6, T-6, W-6, Super W6, 400 Gas, W400, & 450

with Replacement Vertical Delco Distributor
4 Cyl. Tailored Spark Plug Wire Set

B1024-096	Original Type Cotton Braid Wire	\$23.75
B1024-096E	EPDM Wire	\$26.00
B1024-096S	Suppression Wire	\$26.00

Farmall I-9

4 Cyl. Tailored Spark Plug Wire Set

B1024-027	Original Type Cotton Braid Wire	\$23.75
B1024-027E	EPDM Wire	\$26.00

Farmall M & Super M

(See #B1024-028 or #B1024-096 above)

Farmall MD, MDTA, IHC TD6, & McCormick Deering WD-6

4 Cyl. Tailored Spark Plug Wire Set

B1024-030	Original Type Cotton Braid Wire	\$28.75
B1024-030E	EPDM Wire	\$31.25
B1024-030S	Suppression Wire	\$31.25

Farmall Super MD

4 Cyl. Tailored Spark Plug Wire Set

B1024-031	Original Type Cotton Braid Wire	\$28.75
B1024-031E	EPDM Wire	\$31.25

Farmall O4 & T4

(See #B1024-023 or #B1024-093 above)

Farmall O6, Super O6, & T6

(See #B1024-028 or B1024-096 above)

IHC TD-6

(See #B1024-030 above)

IHC TD-9 & McCormick Deering WD-9, Super WD-9, & International 600D, 650D

4 Cyl. Tailored Spark Plug Wire Set

B1024-050	Original Type Cotton Braid Wire	\$29.75
B1024-050E	EPDM Wire	\$34.00
B1024-050S	Suppression Wire	\$34.00

IHC TD-14A, UD-14A, & UD-370

4 Cyl. Tailored Spark Plug Wire Set

B1024-036	Original Type Cotton Braid Wire	\$33.50
B1024-036E	EPDM Wire	\$36.50

IHC TD-18, TD-18A, & UD-18A

6 Cyl. Tailored Spark Plug Wire Set

B1024-037	Original Type Cotton Braid Wire	\$33.50
B1024-037E	EPDM Wire	\$36.50

IHC TD-24A

6 Cyl. Tailored Spark Plug Wire Set

B1024-038	Original Type Cotton Braid Wire	\$33.50
B1024-038E	EPDM Wire	\$36.50

IHC TD-35A

4 Cyl. Tailored Spark Plug Wire Set

B1024-039	Original Type Cotton Braid Wire	\$33.50
B1024-039E	EPDM Wire	\$36.50

IHC UD-14A

(See #B1024-036 above)

IHC UD-18A

(See #B1024-037 above)

IHC UD-370

(See #B1024-036 above)

McCormick Deering W-4

(See #B1024-023 or #B1024-093 above)

McCormick Deering Super W-4

4 Cyl. Tailored Spark Plug Wire Set

B1024-044	Original Type Cotton Braid Wire	\$23.25
B1024-044E	EPDM Wire	\$26.00
B1024-044S	Suppression Wire	\$26.00
B1024-044CS	Cotton Suppression Wire	\$40.75

McCormick Deering W-6 & Super W-6

(See #B1024-028 or #B1024-096 above)

McCormick Deering W-9 & Super W-9

4 Cyl. Tailored Spark Plug Wire Set

B1024-048	Original Type Cotton Braid Wire	\$23.25
B1024-048E	EPDM Wire	\$26.00
B1024-048S	Suppression Wire	\$26.00

McCormick Deering WD-6

(See #B1024-030 above)

McCormick Deering WD-9, Super WD-9

(See #B1024-050 above)

McCormick Deering WD-40, IHC PD-40

4 Cyl. Tailored Spark Plug Wire Set

B1024-052	Original Type Cotton Braid Wire	\$29.75
B1024-052E	EPDM Wire	\$34.00

McCormick Deering WK-40

6 Cyl. Tailored Spark Plug Wire Set

B1024-054	Original Type Cotton Braid Wire	\$40.25
B1024-054E	EPDM Wire	\$43.75

Farmall 100, 130, 140, 200, & 230

4 Cyl. Tailored Spark Plug Wire Set

B1024-017	Original Type Cotton Braid Wire	\$23.75
B1024-017E	EPDM Wire	\$26.00
B1024-017S	Suppression Wire	\$26.00
B1024-017CS	Cotton Suppression Wire	\$40.75

Farmall 240

4 Cyl. Tailored Spark Plug Wire Set

B1024-019	Original Type PVC Wire	\$21.50
B1024-019E	EPDM Wire	\$26.00
B1024-019S	Suppression Wire	\$26.00

Farmall 284 Gas Utility

4 Cyl. Tailored Spark Plug Wire Set

B1024-061	Original Type PVC Wire	\$21.50
B1024-061E	EPDM Wire	\$26.00
B1024-061S	Suppression Wire	\$26.00

Farmall 300, 330, 340, & 350

(See #B1024-023 or #B1024-093 above)

Farmall 354

4 Cyl. Tailored Spark Plug Wire Set

B1024-095	Original Type PVC Wire	\$21.50
B1024-095E	EPDM Wire	\$26.00
B1024-095S	Suppression Wire	\$26.00

Farmall 400 Gas & W400

(See #B1024-028 or #B1024-096 above)

Farmall 400D, W400D, & 450D

4 Cyl. Tailored Spark Plug Wire Set

B1024-097	Original Type PVC Wire	\$26.00
B1024-097E	EPDM Wire	\$31.25
B1024-097S	Suppression Wire	\$31.25

Farmall B404 (404), B424 (424), B2404 (2404), & B2414 (2414/ 414)

4 Cyl. Tailored Spark Plug Wire Set

B1024-070	Original Type PVC Wire	\$26.00
B1024-070E	EPDM Wire	\$31.25
B1024-070S	Suppression Wire	\$31.25

Farmall 434, 444, & 454

4 Cyl. Tailored Spark Plug Wire Set

B1024-072	Original Type PVC Wire	\$21.50
B1024-072E	EPDM Wire	\$26.00
B1024-072S	Suppression Wire	\$26.00

Farmall 450 Gas

(See #B1024-028 or #B1024-096 above)

Farmall 450D

(See #B1024-097 above)

Farmall 454

(See #B1024-072 above)

Farmall 460, 560, 656, 706, 756, 766, 806, 826, 856, 2606, 2656, 2806, 2826, & 2856

6 Cyl. Tailored Spark Plug Wire Set

B1024-076	Original Type PVC Wire	\$31.50
B1024-076E	EPDM Wire	\$37.75
B1024-076S	Suppression Wire	\$37.75

Farmall 464, 504, 544, 574, & 674

4 Cyl. Tailored Spark Plug Wire Set

B1024-077	Original Type PVC Wire	\$21.50
B1024-077E	EPDM Wire	\$26.00
B1024-077S	Suppression Wire	\$26.00

International 600 Gas, W600, 650, W650

4 Cyl. Tailored Spark Plug Wire Set

B1024-081	Original Type Cotton Braid Wire	\$23.75
B1024-081E	EPDM Wire	\$26.00

International 600D

(See #B1024-050 above)

International 650D

(See #B1024-050 above)

Farmall 656, 706, 756, 766, 806, 826, 856

(See #B1024-076 above)

Farmall B2404 (2404) & B2414 (2414/ 414)

(See #B1024-070 above)

Farmall 2544

4 Cyl. Tailored Spark Plug Wire Set

B1024-090	Original Type PVC Wire	\$21.50
B1024-090E	EPDM Wire	\$26.00
B1024-090S	Suppression Wire	\$26.00

Farmall 2606, 2656, 2806, 2826, & 2856

(See #B1024-076 above)

Did You Know?

Farmall tractors were originally a bluish-grey color. It wasn't until 1936 that the bright Farmall Red came to be.

BATTERY CABLES



Our Battery Cables are made from the Proper Gauge Copper, as either **Black Cotton Braided Wire** or **PVC Wire** (whichever is correct for the application), using Soldered & Heat Sealed Brass or Copper Terminals.

Farmall Cub (Up to Serial #224,400)

Replaces IHC/Farmall: #351956R91, Battery Cable to Starting Motor (Negative) **69510DA**, Battery Ground Cable Positive)

B2024-001	Negative Battery Cable, Original Design (Cotton Braided)	\$78.25
B2024-147	Negative Battery Cable, Modern Replacement Design (PVC Cable)	\$35.75
B2000-002	Positive Ground Strap	\$9.50

Farmall Cub (Serial #224,401 to #239,826)

Replaces IHC/Farmall: #356062R91, 387265R91, & 629029R92 Battery Ground Strap (Negative)

#387263R91 Battery Cable to Starting Switch (Positive)

#387264R91 Cable to Starting Switch to Starter

B2000-002	Negative Ground Strap	\$9.50
B2024-003	Positive Battery Cable	\$30.75
B2024-004	Switch to Starter Cable	\$30.00

Farmall Cub (Serial #239,827 & Up)

Replaces IHC/Farmall: #356062R91, 387265R91, & 629029R92

Battery Ground Strap (Negative), **#547143R1**, Battery Cable to Starting Switch (Positive), **#547144R1**, Cable to Starting Switch to Starter (Positive)

B2000-002	Negative Ground Strap	\$9.50
B2024-007	Positive Battery Cable	\$26.00
B2024-008	Switch to Starter Cable	\$36.25

Farmall Cub Lo-Boy (Up to Serial #18,700)

Replaces IHC/Farmall: #351956R91, Battery Cable to Starting Motor (Negative), **#69510DA**, Battery Ground Cable Positive)

B2024-001	Negative Battery Cable, Original Design (Cotton Braided)	\$78.25
B2024-147	Negative Battery Cable, Modern Replacement (PVC Cable)	\$35.75
B2000-002	Positive Ground Strap	\$9.50

Farmall Cub Lo-Boy (Serial #18,701 & Up)

Replaces IHC/Farmall: #356062R91, 387265R91, & 629029R92

Battery Ground Strap (Negative), **#387263R91**, Battery Cable to Starting Switch (Positive), **#387264R91**, Cable to Starting Switch to Starter (Positive)

B2000-002	Negative Ground Strap	\$9.50
B2024-003	Positive Battery Cable	\$30.75
B2024-004	Switch to Starter Cable	\$30.00

Farmall A, AI, AV, B, BN

B2024-009	Negative Battery Cable	\$29.75
B2024-010	Positive Battery Cable	\$26.25

Farmall Super A, Super AI, Super AV

B2024-013	Negative Battery Cable	\$32.25
B2024-014	Positive Battery Cable	\$20.25

Farmall C, Super C

B2024-023	Negative Battery Cable	\$32.25
B2024-024	Positive Battery Cable	\$20.25

Farmall H, HV

Early, with Foot Starter

B2024-027	Negative Battery Cable	\$40.50
B2024-028	Positive Battery Cable	\$32.00
B2024-029	Switch to Starter Cable	\$36.50

Farmall H, HV

Late, with Starter Button By Control Box

B2024-030	Negative Battery Cable	\$45.25
B2024-031	Positive Battery Cable	\$32.00
B2024-032	Switch to Starter Cable	\$46.00

Farmall Super H, Super HV

(Up To Serial #19,234)

B2024-033	Negative Battery Cable	\$42.25
B2024-034	Positive Battery Cable	\$28.00

Farmall Super H, Super HV

(Serial #19,234 & Up)

Battery Under the Seat

B2024-035	Negative Battery Cable	\$67.50
B2024-145	Negative Battery Cable with Original Steel Armor	\$87.50
B2000-006	Positive Ground Strap	\$13.50

Farmall M, MV, MD, MDV

B2024-046	Negative Battery Cable	\$32.00
B2024-047	Positive Battery Cable	\$36.75
B2024-048	Switch to Starter Cable	\$50.00

Farmall Super M, Super MV

(Serial #F501 to 28174 & L500001 to 504801)

with Battery Under the Fuel Tank

B2024-055	Negative Battery Cable	\$32.00
B2024-056	Positive Battery Cable	\$36.75
B2024-057	Switch to Starter Cable	\$50.00

Farmall Super M, Super MV, Super MTA

MD, Super MDV, Super MDTA

(Serial #28,175 & Up, L504,802 & Up)

with Battery Under The Seat

B2024-058	Negative Battery Cable	\$73.00
B2024-144	Negative Battery Cable with Original Steel Armor	\$93.00
B2000-006	Positive Ground Strap	\$13.50

Farmall Super MD, Super MDV

(Serial #F501 to 28,174 & L500,001 to 504,801)

with Battery Under the Fuel Tank

B2024-060	Negative Battery Cable	\$32.00
B2024-061	Positive Battery Cable	\$36.75
B2024-062	Switch to Starter Cable	\$50.00

Farmall ODS6

B2024-063	Negative Battery Cable	\$48.50
B2024-064	Positive Battery Cable	\$33.75
B2024-065	Switch to Starter Cable	\$45.25
B2024-066	Battery To Battery Jumper Cable	\$31.25

Farmall OS6

B2024-067	Negative Battery Cable	\$44.50
B2024-068	Positive Battery Cable	\$24.75
B2024-069	Switch to Starter Cable	\$42.75

Farmall T6

B2024-070	Negative Battery Cable	\$73.00
B2000-008	Positive Ground Strap	\$15.50

Farmall TD6

B2024-071	Negative Battery Cable	\$108.75
B2000-008	Positive Ground Strap	\$15.50
B2024-072	Switch to Starter Cable	\$38.25
B2024-073	Battery To Battery Jumper Cable	\$32.50

Farmall W4

B2024-074	Negative Battery Cable	\$44.50
B2024-075	Positive Battery Cable	\$28.00
B2024-076	Switch to Starter Cable	\$42.00

Farmall Super W4

B2024-077	Negative Battery Cable	\$31.00
B2000-004	Positive Ground Strap	\$10.50

McCormick Deering W6

B2024-078	Negative Battery Cable	\$44.50
B2024-079	Positive Battery Cable	\$24.75
B2024-080	Switch to Starter Cable	\$42.75

McCormick Deering Super W6

B2024-081	Negative Battery Cable	\$44.50
B2024-082	Positive Battery Cable	\$24.75
B2024-083	Switch to Starter Cable	\$42.75

McCormick Deering Super W6TA

B2024-084	Negative Battery Cable	\$44.50
B2024-085	Positive Battery Cable	\$32.25
B2024-083	Switch to Starter Cable	\$42.75

McCormick Deering WD6

B2024-087	Negative Battery Cable	\$48.75
B2024-088	Positive Battery Cable	\$33.75
B2024-089	Switch to Starter Cable	\$45.25
B2024-066	Battery To Battery Jumper Cable	\$31.25

McCormick Deering Super WD6

B2024-090	Battery To Battery Jumper Cable	\$26.00
B2024-091	Negative Battery Cable	\$36.75
B2024-092	Positive Battery Cable	\$32.25

McCormick Deering W9

B2024-093	Negative Battery Cable	\$31.50
B2024-094	Positive Battery Cable	\$38.75

McCormick Deering WD9

B2024-141	Negative Battery Cable	\$30.00
B2024-142	Positive Battery Cable	\$33.75
B2024-143	Battery To Battery Jumper Cable	\$35.75

IHC W-400

B2024-122	Negative Battery Cable	\$44.50
B2024-123	Positive Battery Cable	\$32.25
B2024-124	Switch to Starter Cable	\$42.75

Farmall 100

B2024-023	Negative Battery Cable	\$32.25
B2024-024	Positive Battery Cable	\$20.25

Farmall 130

B2024-023	Negative Battery Cable	\$32.25
B2024-024	Positive Battery Cable	\$20.25

Farmall 140 (Up To Serial #26,800)

B2024-099	Negative Battery Cable	\$34.50
B2024-100	Positive Battery Cable	\$20.25

Farmall 140 (Serial #26,801 to 45,000)

B2000-006	Negative Ground Strap	\$13.50
B2024-101	Positive Battery Cable	\$20.75
B2024-137	Switch to Starter Cable	\$25.25

Farmall 140 (Serial #45,001 & Up)

B2000-006	Negative Ground Strap	\$13.50
B2024-102	Positive Battery Cable	\$20.75
B2024-103	Switch to Starter Cable	\$17.00

Farmall 200

B2024-023	Negative Battery Cable	\$32.25
B2024-024	Positive Battery Cable	\$20.25

Farmall 230

B2024-023	Negative Battery Cable	\$32.25
B2024-024	Positive Battery Cable	\$20.25

Farmall 240

B2024-108	Negative Battery Cable	\$34.50
B2000-006	Positive Ground Strap	\$13.50

IHC 284 Utility

B2024-109	Negative Battery Cable	\$60.75
B2024-110	Positive Battery Cable	\$69.50

Farmall 300, 330 Row Crop

B2024-111	Negative Battery Cable	\$73.00
B2024-148	Negative Battery Cable with Original Steel Type Armor	\$93.00
B2000-006	Positive Ground Strap	\$13.50

IHC 300 Utility

B2024-112	Negative Battery Cable	\$36.75
B2000-006	Positive Ground Strap	\$13.50

Farmall 340 Row Crop

B2024-155	Negative Battery Cable	\$88.50
B2024-156	Negative Battery Cable with Original Steel Armor	\$108.50
B2000-006	Positive Ground Strap	\$13.50

IHC 340 Utility

B2024-114	Negative Battery Cable	\$36.75
B2000-006	Positive Ground Strap	\$13.50

IHC T340 Crawler

B2024-150	Negative Battery Cable	\$76.75
B2000-006	Positive Ground Strap	\$13.50

Farmall 350 Gas Row Crop

B2024-153	Negative Battery Cable	\$80.50
B2024-154	Negative Battery Cable with Original Steel Armor	\$100.50
B2000-006	Positive Ground Strap	\$13.50

Farmall 350 Diesel Row Crop

B2024-116	Negative Battery Cable	\$80.50
B2024-152	Negative Battery Cable with Original Steel Type Armor	\$100.50
B2000-006	Positive Ground Strap	\$13.50
B2024-117	Starter Solenoid to Manifold Heater Solenoid Cable	\$23.50
B2024-118	Manifold Heater Solenoid to Manifold Heater Cable	\$28.00

IHC 350 Gas Utility

B2024-119	Negative Battery Cable	\$36.75
B2000-006	Positive Ground Strap	\$13.50

Farmall 400, 450 (Gas & Diesel)

B2024-120	Negative Battery Cable	\$76.25
B2024-146	Negative Battery Cable with Original Steel Type Armor	\$96.25
B2000-006	Positive Ground Strap	\$13.50

Farmall 460 Gas, 460HC Gas

B2024-127	Positive Battery Cable	\$55.75
B2000-006	Negative Ground Strap	\$13.50

***For All Battery Cables, we can add Original Type Steel Armor for an additional cost of \$20.00.**

Farmall 460 Diesel, 460DHC Diesel

B2024-128	Positive Battery Cable	\$73.00
Replaces IHC/Farmall: #370383R91		
B2000-006	Negative Ground Strap	\$13.50
Replaces IHC/Farmall: #370389R91, 377995R91		
B2024-151	Battery To Battery Jumper Cable	\$34.75
Replaces IHC/Farmall: #370394R91, 3779946R1		

Farmall 504 Gas

B2000-007	Negative Ground Strap	\$14.50
B2024-129	Positive Battery Cable	\$39.50

Farmall 560 Gas

B2024-130	Positive Battery Cable	\$55.75
B2000-006	Negative Ground Strap	\$13.50

Farmall 560 Diesel

B2024-128	Positive Battery Cable	\$73.00
Replaces IHC/Farmall: #370383R91		
B2000-006	Negative Ground Strap	\$13.50
Replaces IHC/Farmall: #370389R91, 377995R91		
B2024-151	Battery To Battery Jumper Cable	\$34.75
Replaces IHC/Farmall: #370394R91, 3779946R1		

IHC 656 Gas

B2000-007	Negative Ground Strap	\$14.50
B2024-132	Positive Battery Cable	\$42.00

Farmall/IHC 656 Diesel

B2000-007	Negative Ground Strap	\$14.50
B2024-133	Positive Battery Cable	\$36.75

Farmall/IHC 706 Gas

B2000-007	Negative Ground Strap	\$14.50
Replaces IHC/Farmall: #384198R91		
B2024-134	Positive Battery Cable	\$30.75
Replaces IHC/Farmall: #378326R91		

IHC 706 Diesel

B2000-006	Negative Ground Strap	\$13.50
Replaces IHC/Farmall: #378760R91, 537063R1		
B2024-139	Positive Battery Cable	\$45.50
Replaces IHC/Farmall: #383726R91, 629929R92		
B2024-149	Battery To Battery Jumper Cable	\$60.50
Replaces IHC/Farmall: #383617R91, 534376R1		

IHC 806 Gas

B2000-007	Negative Ground Strap	\$14.50
B2024-136	Positive Battery Cable	\$25.00

IHC 806 Diesel

B2000-006	Negative Ground Strap	\$13.50
Replaces IHC/Farmall: #378760R91, 537063R1		
B2024-139	Positive Battery Cable	\$45.50
Replaces IHC/Farmall: #383726R91, 629929R92		
B2024-149	Battery To Battery Jumper Cable	\$60.50
Replaces IHC/Farmall: #383617R91, 534376R1		

Farmall 826 Diesel

B2000-006	Negative Ground Strap	\$13.50
Replaces IHC/Farmall: #378760R91, 537063R1		
B2024-139	Positive Battery Cable	\$45.50
Replaces IHC/Farmall: #383726R91, 629929R92		
B2024-149	Battery To Battery Jumper Cable	\$60.50
Replaces IHC/Farmall: #383617R91, 534376R1		

Farmall 856 Diesel

B2000-006	Negative Ground Strap	\$13.50
Replaces IHC/Farmall: #378760R91, 537063R1		
B2024-139	Positive Battery Cable	\$45.50
Replaces IHC/Farmall: #383726R91, 629929R92		
B2024-149	Battery To Battery Jumper Cable	\$60.50
Replaces IHC/Farmall: #383617R91, 534376R1		

Farmall 966

B2000-006	Negative Ground Strap	\$13.50
Replaces IHC/Farmall: #378760R91, 537063R1		
B2024-139	Positive Battery Cable	\$45.50
Replaces IHC/Farmall: #383726R91, 629929R92		
B2024-149	Battery To Battery Jumper Cable	\$60.50
Replaces IHC/Farmall: #383617R91, 534376R1		

Farmall 1066

B2000-006	Negative Ground Strap	\$13.50
Replaces IHC/Farmall: #378760R91, 537063R1		
B2024-139	Positive Battery Cable	\$45.50
Replaces IHC/Farmall: #383726R91, 629929R92		
B2024-149	Battery To Battery Jumper Cable	\$60.50
Replaces IHC/Farmall: #383617R91, 534376R1		

Farmall 1206

B2000-006	Negative Ground Strap	\$13.50
B2024-140	Positive Battery Cable	\$32.00

Farmall 1466

B2000-006	Negative Ground Strap	\$13.50
Replaces IHC/Farmall: #378760R91, 537063R1		
B2024-139	Positive Battery Cable	\$45.50
Replaces IHC/Farmall: #383726R91, 629929R92		
B2024-149	Battery To Battery Jumper Cable	\$60.50
Replaces IHC/Farmall: #383617R91, 534376R1		

Farmall 1468

B2000-006	Negative Ground Strap	\$13.50
Replaces IHC/Farmall: #378760R91, 537063R1		
B2024-139	Positive Battery Cable	\$45.50
Replaces IHC/Farmall: #383726R91, 629929R92		
B2024-149	Battery To Battery Jumper Cable	\$60.50
Replaces IHC/Farmall: #383617R91, 534376R1		

Farmall Hydro 100

B2000-006	Negative Ground Strap	\$13.50
Replaces IHC/Farmall: #378760R91, 537063R1		
B2024-139	Positive Battery Cable	\$45.50
Replaces IHC/Farmall: #383726R91, 629929R92		
B2024-149	Battery To Battery Jumper Cable	\$60.50
Replaces IHC/Farmall: #383617R91, 534376R1		



WIRING HARNESSSES

Our Wire Harnesses are made with our **premium cotton braid and/or PVC wire**.

They have the **correct gauge, color, wire, & fuse holders** (if needed).

All terminals are **soldered according to the original**.

(Harnesses do not include Battery Cables & Spark Plug Wires; however, we can supply these as separate products.)

NO HIDDEN COSTS, NOTHING EXTRA TO BUY!

Farmall Cub (Serial #501-115,402)

Complete Wire Harness

B3024-001	Original Design with Generator & Cutout Relay (4 Wire)	Replaces IHC/Farmall: #351325R91, Main Harness (4 Wire); #120692, Lead, Ammeter to Light Switch; #356937R91, Lead, Generator "A" to Relay "Gen"; #58189D, & #358110R92, Lead, Ignition Switch to Magneto or Distributor; #358111R91, Lead, Rear Light with Conduit; #357929R91, Lead, Coil to Distributor; #358571R91, Lead, Light Switch to Ignition Switch	\$137.50
B3024-241	Modified for 1 Wire Alternator	See #B3024-001	\$137.50
B3024-257	Modified for Delco 10SI Alternator (3 Wire)	See #B3024-001	\$137.50
B3024-274	Modified for ND Alternator (Small 2 Wire)	See #B3024-001	\$137.50
B3024-372	Rear Light Lead	Included with the Complete Wire Harnesses Listed Above	\$21.00

Farmall Cub (Serial #115,403-165,152)

Complete Wire Harness

B3024-002	Original Design with Generator & Voltage Regulator (7 Wire) (Can fit earlier Serial #'s with Voltage Regulators too)	Replaces IHC/Farmall: #354252R91, Main Harness (7 Wire); #354248R11, & #358112R92, Lead, Generator "A" to Regulator "Gen"; #354249R11, & #358113R92, Lead, Generator "F" to Regulator "F"; #354232R91, & #354233R91, Fuse Holder With Leads & Fuse; #30699DX, & #358111R91, Lead, Rear Light with Conduit; #58189D, & #358110R92, Lead, Ignition Switch to Magneto or Distributor	\$151.50
B3024-237	Modified for 1 Wire Alternator	See #B3024-002	\$151.50
B3024-255	Modified for Delco 10SI Alternator (3 Wire) & Voltage Regulator (7 Wire)	See #B3024-002	\$151.50
B3024-289	Modified for ND Alternator (Small, 2 Wire)	See #B3024-002	\$151.50
B3024-372	Rear Light Lead	Included with the Complete Wire Harnesses Listed Above	\$21.00

Farmall Cub (Serial #165,153-210,000)

Complete Wire Harness

B3024-003	Original Design with Generator & Voltage Regulator (8 Wire)	Replaces IHC/Farmall: #363507R91, Main Harness (8 Wire); #354248R11, & #358112R92, Lead, Generator "A" to Regulator "Gen"; #354249R11, & #358113R92, Lead, Generator "F" to Regulator "F"; #354232R91, & #354233R91, Fuse Holder With Leads & Fuse; #363508R91, Lead, Rear Light with Conduit; #58189D, & #358110R92, Lead, Ignition Switch to Magneto or Distributor; #357929R91, Lead, Coil to Distributor	\$172.25
B3024-268	Modified for 1 Wire Alternator	See #B3024-003	\$172.25
B3024-275	Modified for ND Alternator (Small 2 Wire)	See #B3024-003	\$172.25

Farmall Cub (Serial #210,001-224,400)

Complete Wire Harness

B3024-004	Original Design with Generator & Voltage Regulator	Replaces IHC/Farmall: #371032R91, Main Harness; #354248R11, & #358112R92, Lead, Generator "A" to Regulator "Gen"; #354249R11, & #358113R92, Lead, Generator "F" to Regulator "F"; #354232R91, & #354233R91, Fuse Holder With Leads & Fuse; #371033R91, Lead, Rear Light with Conduit; #357929R91, Lead, Coil to Distributor	\$213.25
B3024-256	Modified for 1 Wire Alternator	See #B3024-004	\$213.25
B3024-329	Modified for Delco 10SI Alternator (3 Wire)	See #B3024-004	\$213.25
B3024-293	Original Design with Generator & Regulator Made With Modern PVC Wire & Nylon Braid	See #B3024-004	\$213.25

Farmall Cub (Serial #224,401-227,700)

Complete Wire Harness

B3024-005	Original Design with Generator	Replaces IHC/Farmall: #387262R91, & #404353R1, Main Harness; #354248R11, & #358112R92, Lead, Generator "A" to Regulator "Gen"; #354249R11, & #358113R92, Lead, Generator "F" to Regulator "F"; #376852R91, Fuse Holder; #387310R91, Cable, Fuse Holder to Light Switch; #387266R91, Cable, Start Switch to Charge Indicator; #387312R91, Rear Light Harness; #357929R91, Lead, Coil to Distributor	\$213.25
B3024-298	Modified for 1 Wire Alternator	See #B3024-005	\$213.25

Farmall Cub (Serial #227,701-239,826)

Complete Wire Harness

B3024-006	Original Design with Generator	Replaces IHC/Farmall: #387262R91, & #404353R1, Main Harness; #354248R11, & #358112R92, Lead, Generator "A" to Regulator "Gen"; #354249R11, & #358113R92, Lead, Generator "F" to Regulator "F"; #376852R91, Fuse Holder; #387310R91, Cable, Fuse Holder to Light Switch; #387266R91, Cable, Start Switch to Charge Indicator; #387312R91, Rear Light Harness; #404353R1, Flashing Light Harness; #394332R91, & #404389R1, Cable, Flasher to Light; #357929R91, Lead, Coil to Distributor	\$227.00
B3024-385	Modified for 1 Wire Alternator	See #B3024-006	\$227.00

Farmall Cub (Serial #239,827-248,124)

Complete Wire Harness

B3024-007	Original Design with Generator	Replaces IH/Farmall: #547142R1, Main Harness; #354248R11, & #358112R92, Lead, Generator "A" to Regulator "Gen"; #354249R11, & #358113R92, Lead, Generator "F" to Regulator "F"; #376852R91, Fuse Holder; #404401R1, Cable, Fuse Holder to Light Switch; #387312R91, Rear Light Harness; #404353R1, Flashing Light Harness; #394332R91, & #404389R1, Cable, Flasher to Light; #547145R1, Neutral Safety Harness; #357929R91, Lead, Coil to Distributor	\$237.75
B3024-276	Modified for 1 Wire Alternator	See #B3024-007	\$237.75

Farmall Cub (Serial #248,125 & Up)

B3024-008	Complete Wire Harness Original Design with Factory Alternator	Replaces IH/Farmall: #107588R1, Main Harness; #376852R91, Fuse Holder; #404401R1, Cable, Fuse Holder to Light Switch; #387312R91, Rear Light Harness; #547145R1, Neutral Safety Harness; #404353R1, Flashing Light Harness; #394332R91, & 404389R1, Cable, Flasher to Light; #357929R91, Lead, Coil to Distributor	\$223.50
------------------	---	---	-----------------

Farmall Cub Lo-Boy (Serial #501 to 10,000)

Complete Wire Harness

B3024-003	Original Design with Generator & Voltage Regulator (8 Wire)	Replaces IHC/Farmall: #363507R91, Main Harness (8 Wire); #354248R11, & #358112R92, Lead, Generator "A" to Regulator "Gen"; #354249R11, & #358113R92, Lead, Generator "F" to Regulator "F"; #354232R91, & #354233R91, Fuse Holder With Leads & Fuse; #363508R91, Lead, Rear Light with Conduit; #58189D, & #358110R92, Lead, Ignition Switch to Magneto or Distributor; #357929R91, Lead, Coil to Distributor	\$172.25
B3024-268	Modified for 1 Wire Alternator & Voltage Regulator (8 Wire)	See #B3024-003	\$172.25
B3024-275	Modified for ND Alternator (Small 2 Wire)	See #B3024-003	\$172.25

Farmall Cub Lo-Boy (Serial #10,001-18,700)

Complete Wire Harness

B3024-004	Original Design with Generator & Voltage Regulator	Replaces IHC/Farmall: #371032R91, Main Harness; #354248R11, & #358112R92, Lead, Generator "A" to Regulator "Gen"; #354249R11, & #358113R92, Lead, Generator "F" to Regulator "F"; #354232R91, & #354233R91, Fuse Holder With Leads & Fuse; #371033R91, Lead, Rear Light with Conduit; #357929R91, Lead, Coil to Distributor	\$213.25
B3024-256	Modified for 1 Wire Alternator	See #B3024-004	\$213.25
B3024-329	Modified for Delco 10SI Alternator (3 Wire)	See #B3024-004	\$213.25

Farmall Cub Lo-Boy (Serial #18,701-21,575)

Complete Wire Harness

B3024-005	Original Design with Generator	Replaces IHC/Farmall: #387262R91, & #404353R1, Main Harness; #354248R11, & #358112R92, Lead, Generator "A" to Regulator "Gen"; #354249R11, & #358113R92, Lead, Generator "F" to Regulator "F"; #376852R91, Fuse Holder; #387310R91, Cable, Fuse Holder to Light Switch; #387266R91, Cable, Start Switch to Charge Indicator; #387312R91, Rear Light Harness; #357929R91, Lead, Coil to Distributor	\$213.25
B3024-298	Modified for 1 Wire Alternator	See #B3024-005	\$213.25

Farmall Cub Lo-Boy (Serial #21,576 & Up)

Complete Wire Harness

B3024-006	Original Design with Generator	Replaces IHC/Farmall: #387262R91, & #404353R1, Main Harness; #354248R11, & #358112R92, Lead, Generator "A" to Regulator "Gen"; #354249R11, & #358113R92, Lead, Generator "F" to Regulator "F"; #376852R91, Fuse Holder; #387310R91, Cable, Fuse Holder to Light Switch; #387266R91, Cable, Start Switch to Charge Indicator; #387312R91, Rear Light Harness; #404353R1, Flashing Light Harness; #394332R91, & #404389R1, Cable, Flasher to Light; #357929R91, Lead, Coil to Distributor	\$227.00
B3024-385	Modified for 1 Wire Alternator	See #B3024-006	\$227.00

IHC/Farmall Cub Lo-Boy 154

B3026-016	Complete Wire Harness	Original Design with Starter/ Generator	\$186.50
B3026-017	Dash & Engine Harness Only	Made with PVC Wire	\$106.00
B3026-018	Rear Harness Only	Made with PVC Wire	\$89.75

IHC/Farmall A

Complete Wire Harness

B3024-013	Original Design with Generator	Replaces IHC/Farmall: #51998D Wiring Harness	\$159.75
B3024-161	Modified for Delco 10SI Alternator (3 Wire)	See #B3024-013	\$159.75
B3024-162	Modified for 1 Wire Alternator	See #B3024-013	\$159.75

IHC/Farmall Super A (Up to Serial #286,221)

Complete Wire Harness

B3024-013	Original Design with Generator	Replaces IHC/Farmall: #51998D Wiring Harness	\$159.75
B3024-161	Modified for Delco 10SI Alternator (3 Wire)	See #B3024-013	\$159.75
B3024-162	Modified for 1 Wire Alternator	See #B3024-013	\$159.75

IHC/Farmall Super A (Serial #286,222 & Up)

Complete Wire Harness

B3024-015	Original Design with Generator		\$159.75
B3024-161	Modified for Delco 10SI Alternator (3 Wire)	See #B3024-013	\$159.75
B3024-162	Modified for 1 Wire Alternator	See #B3024-013	\$159.75

IHC/Farmall B, BN

Complete Wire Harness

B3024-013	Original Design with Generator	Replaces IHC/Farmall: #51998D Wiring Harness	\$159.75
B3024-161	Modified for Delco 10SI Alternator (3 Wire)	See #B3024-013	\$159.75
B3024-162	Modified for 1 Wire Alternator	See #B3024-013	\$159.75

IHC/Farmall C (Up to Serial #47,125)

Complete Wire Harness

B3024-019	Original Design with Generator & Cutout Relay	Replaces IHC/Farmall: #354243R92, 351917R92, 358109R92	\$159.75
B3024-159	Modified for Delco 10SI Alternator (3 Wire)	See #B3024-056	\$159.75
B3024-160	Modified for 1 Wire Alternator (Cotton Braid)	See #B3024-056	\$159.75
B3024-395	Modified for 1 Wire Alternator (PVC & Nylon Braid)	See #B3024-056	\$159.75
B3024-369	Rear Light Harness (1 Wire with Asphaltic Wire Loom)	Replaces IHC/Farmall: #358118R91	\$25.75

Head Light Harness

B3024-304	Original Type made with Correct Cotton Braid Wire & Original Type Braided Sheath (1 Wire)	Replaces IHC/Farmall: #52973DA	\$31.75
B3024-304M	Modern Type, as #B3024-304, but made with PVC Wire	Replaces IHC/Farmall: #52973DA	\$19.75

IHC/Farmall C (Serial #47,126 & Up)

Complete Wire Harness

B3024-056	Original Design with Generator & Voltage Regulator Mounted On the Engine (Cotton Braid)	Replaces IHC/Farmall: #354243R92, 351917R92, 358109R92	\$159.75
B3024-392	Original Design with Generator & Voltage Regulator Mounted On the Engine (PVC & Nylon Braid)	See #B3024-056	\$159.75
B3024-159	Modified for Delco 10SI Alternator (3 Wire)	See #B3024-056	\$159.75
B3024-160	Modified for 1 Wire Alternator	See #B3024-056	\$159.75
B3024-369	Rear Light Harness (1 Wire with Asphaltic Wire Loom)	Replaces IHC/Farmall: #358118R91	\$25.75

Head Light Harness

B3024-304	Original Type made with Correct Cotton Braid Wire & Original Type Braided Sheath (1 Wire)	Replaces IHC/Farmall: #52973DA (Included in Complete Wire Harnesses listed above)	\$31.75
B3024-304M	Modern Type, as #B3024-304, but made with PVC Wire	Replaces IHC/Farmall: #52973DA	\$19.75

IHC/Farmall Super C

Complete Wire Harness

B3024-056	Original Design with Generator & Voltage Regulator	Replaces IHC/Farmall: #354243R92, 351917R92, 358109R92	\$159.75
B3024-159	Modified for Delco 10SI Alternator (3 Wire)	See #B3024-056	\$159.75
B3024-160	Modified for 1 Wire Alternator	See #B3024-056	\$159.75
B3024-369	Rear Light Harness (1 Wire with Asphaltic Wire Loom)	Replaces IHC/Farmall: #358118R91	\$25.75

Head Light Harness

B3024-304	Original Type made with Correct Cotton Braid Wire & Original Type Braided Sheath (1 Wire)	Replaces IHC/Farmall: #52973DA (Included in Complete Wire Harnesses listed above)	\$31.75
B3024-304M	Modern Type, as #B3024-304, but made with PVC Wire	Replaces IHC/Farmall: #52973DA	\$19.75

IHC/Farmall H, HV (Up to Serial #340,953)

Complete Wire Harness

B3024-020	Original Design with Generator & Cutout Relay	Replaces IHC/Farmall: #354257R91, 354297R91, 52973DA, 54235D, 365020R91, 365021R91	\$193.50
B3024-024	Modified For Regulator on Generator	See #B3024-020	\$193.50
B3024-194	Modified for 1 Wire Alternator	See #B3024-020	\$193.50
B3024-195	Modified for Delco 10SI Alternator (3 Wire)	See #B3024-020	\$193.50
B3024-306	Rear Light Harness (1 Wire with Steel Conduit)	Replaces IHC/Farmall: #358311R91 (Included in Complete Wire Harnesses listed above)	\$37.25

Head Light Harness

B3024-304	Original Type made with Correct Cotton Braid Wire & Original Type Braided Sheath (1 Wire)	Replaces IHC/Farmall: #52973DA (Included in Complete Wire Harnesses listed above)	\$31.75
B3024-304M	Modern Type, as #B3024-304, but made with PVC Wire	Replaces IHC/Farmall: #52973DA	\$19.75

IHC/Farmall H, HV (Serial #340,954, & Up)

Complete Wire Harness

B3024-022	Original Design with Generator & Voltage Regulator	Replaces IHC/Farmall: #354257R91, 3605020R91, 52973DA, 358161R91	\$193.50
B3024-024	Modified For Regulator on Generator	See #B3024-022	\$193.50
B3024-194	Modified for 1 Wire Alternator	See #B3024-022	\$193.50
B3024-195	Modified for Delco 10SI Alternator (3 Wire)	See #B3024-022	\$193.50
B3024-306	Rear Light Harness (1 Wire with Steel Conduit)	Replaces IHC/Farmall: #358311R91 (Included in Complete Wire Harnesses listed above)	\$37.25

Head Light Harness

B3024-304	Original Type made with Correct Cotton Braid Wire & Original Type Braided Sheath (1 Wire)	Replaces IHC/Farmall: #52973DA (Included in Complete Wire Harnesses listed above)	\$31.75
------------------	---	---	----------------

B3024-304M	Modern Type, as #B3024-304, but made with PVC Wire	Replaces IHC/Farmall: #52973DA	\$19.75
-------------------	--	---------------------------------------	----------------

IHC/Farmall Super H (Up to Serial #19,233)

Complete Wire Harness

B3024-026	Original Design with Voltage Regulator	Replaces IHC/Farmall: #354257R91, 354297R91, 52973DA, 365020R91, 365021R91	\$200.25
B3024-246	Modified for 1 Wire Alternator	See #B3024-026	\$200.25
B3024-247	Modified for Delco 10SI Alternator (3 Wire)	See #B3024-026	\$200.25
B3024-306	Rear Light Harness (1 Wire with Steel Conduit)	Replaces IHC/Farmall: #358311R91 (Included in Complete Wire Harnesses listed above)	\$37.25

Head Light Harness

B3024-304	Original Type made with Correct Cotton Braid Wire & Original Type Braided Sheath (1 Wire)	Replaces IHC/Farmall: #52973DA (Included in Complete Wire Harnesses listed above)	\$31.75
B3024-304M	Modern Type, as #B3024-304, but made with PVC Wire	Replaces IHC/Farmall: #52973DA	\$19.75

IHC/Farmall Super H (Serial #19,234 & Up)

Complete Wire Harness

B3024-027	Original Design with Generator & Voltage Regulator	Replaces IHC/Farmall: #354257R91, 3605020R91, 52973DA, 358161R91	\$213.25
B3024-243	Modified for 1 Wire Alternator	See #B3024-027	\$213.25
B3024-258	Modified for Delco 10SI Alternator (3 Wire)	See #B3024-027	\$213.25
B3024-302	Rear Light Harness (2 Wire with Steel Conduit)	Replaces IHC/Farmall: #358915R91 (Included in Complete Wire Harnesses listed above)	\$46.50
B3024-303	Head Light Harness (2 Wire)	Replaces IHC/Farmall: #358916R91 (Included in Complete Wire Harnesses listed above)	\$42.00

IHC/Farmall I4

Complete Wire Harness

B3024-028	Original Design with Generator & Cutout Relay		\$200.25
B3024-029	Original Design with Generator & Voltage Regulator		\$200.25
B3024-250	Original Design with Voltage Regulator Mounted on the Generator		\$200.25
B3024-383	Modified for 1 Wire Alternator		\$200.25

IHC/Farmall I6 (Serial #501-36,779)

Complete Wire Harness

B3024-053	Original Design with Generator & Cutout Relay		\$200.25
B3024-287	Modified for 1 Wire Alternator		\$200.25
B3024-292	Original Design with Generator & Cutout Relay Made With Modern PVC Wire & Nylon Braid		\$200.25

IHC/Farmall I6 (Serial #36,780 & Up)

Complete Wire Harness

B3024-054	Original Design with Generator & Voltage Regulator		\$200.25
B3024-334	Modified for 1 Wire Alternator		\$200.25

IHC/Farmall M, MV (Up to Serial #229,910)

Complete Wire Harness

B3024-030	Original Design with Generator & Cutout Relay	Replaces IHC/Farmall: #354297R91, 354296R91, 52973DA, 56281D	\$200.25
B3024-187	Modified for Regulator on Generator	See #B3024-030	\$200.25
B3024-193	Modified for 1 Wire Alternator	See #B3024-030	\$200.25
B3024-176	Modified for Delco 10SI Alternator (3 Wire)	See #B3024-030	\$200.25
B3024-031	Original Design with Generator & Cutout Relay Made with Modern PVC Wire & Nylon Braid	See #B3024-030	\$200.25
B3024-299	Basic Wire Harness , Modified for a 1 Wire Alternator, Made with Modern PVC Wire & Nylon Braid		\$35.00
B3024-305	Rear Light Harness (1 Wire with Steel Conduit)	Replaces IHC/Farmall: #358121R91 (Included in Complete Wire Harnesses listed above)	\$37.25

Head Light Harness

B3024-304	Original Type made with Correct Cotton Braid Wire & Original Type Braided Sheath (1 Wire)	Replaces IHC/Farmall: #52973DA (Included in Complete Wire Harnesses listed above)	\$31.75
B3024-304M	Modern Type - as #B3024-304, but made with PVC Wire	Replaces IHC/Farmall: #52973DA	\$19.75

IHC/Farmall M, MV (Serial #229,911 & Up)

Complete Wire Harness

B3024-032	Original Design with a Generator & the Voltage Regulator Mounted on the Tractor	Replaces IHC/Farmall: #354297R91, 354296R91, 52973DA	\$200.25
B3024-187	Modified for a Voltage Regulator Mounted on Generator	See #B3024-032	\$200.25
B3024-193	Modified for 1 Wire Alternator	See #B3024-032	\$200.25
B3024-176	Modified for Delco 10SI Alternator (3 Wire)	See #B3024-032	\$200.25
B3024-299	Basic Wire Harness , Modified for a 1 Wire Alternator, Made with Modern PVC Wire & Nylon Braid		\$35.00
B3024-305	Rear Light Harness (1 Wire with Steel Conduit)	Replaces IHC/Farmall: #358121R91 (Included in Complete Wire Harnesses listed above)	\$37.25

Head Light Harness

B3024-304	Original Type made with Correct Cotton Braid Wire & Original Type Braided Sheath (1 Wire)	Replaces IHC/Farmall: #52973DA (Included in Complete Wire Harnesses listed above)	\$31.75
B3024-304M	Modern Type- as #B3024-304, but made with PVC Wire	Replaces IHC/Farmall: #52973DA	\$19.75

IHC/Farmall MD, MDV

Complete Wire Harness

B3024-034	Original Design with Generator & Cutout Relay	Replaces IHC/Farmall: #52973D, 52973DA, 62504D, 62505D, 62503D	\$200.25
B3024-036	Original Design with Generator & Voltage Regulator	Replaces IHC/Farmall: #52973D, 52973DA, 62504D, 62505D, 355703R91	\$200.25
B3024-249	Modified for 1 Wire Alternator		\$200.25
B3024-305	Rear Light Harness (1 Wire with Steel Conduit)	Replaces IHC/Farmall: #358121R91 (Included in Complete Wire Harnesses listed above)	\$37.25

Head Light Harness

B3024-304	Original Type made with Correct Cotton Braid Wire & Original Type Braided Sheath (1 Wire)	Replaces IHC/Farmall: #52973DA (Included in Complete Wire Harnesses listed above)	\$31.75
B3024-304M	Modern Type- as #B3024-304, but made with PVC Wire	Replaces IHC/Farmall: #52973DA	\$19.75

IHC/Farmall Super M (Serial #F501-F28174) (Serial #L500001-L504801)

with Battery Under the Fuel Tank

Complete Wire Harness

B3024-032	Original Design with a Generator & the Voltage Regulator Mounted on the Tractor	Replaces IHC/Farmall: #354297R91, 354296R91, 52973DA	\$200.25
B3024-193	Modified for 1 Wire Alternator	See #B3024-032	\$200.25
B3024-176	Modified for Delco 10SI Alternator (3 Wire)	See #B3024-032	\$200.25
B3024-299	Basic Wire Harness , Modified for a 1 Wire Alternator, Made with Modern PVC Wire & Nylon Braid		\$35.00
B3024-305	Rear Light Harness (1 Wire with Steel Conduit)	Replaces IHC/Farmall: #358121R91 (Included in Complete Wire Harnesses listed above)	\$37.25

Head Light Harness

B3024-304	Original Type made with Correct Cotton Braid Wire & Original Type Braided Sheath (1 Wire)	Replaces IHC/Farmall: #52973DA (Included in Complete Wire Harnesses listed above)	\$31.75
B3024-304M	Modern Type- as #B3024-304, but made with PVC Wire	Replaces IHC/Farmall: #52973DA	\$19.75

IHC/Farmall Super M & Super MTA (Serial #F28175 & Up) (Serial #L504802 & Up)

with Battery Under the Seat

Complete Wire Harness

B3024-040	Original Design with Generator & Voltage Regulator		\$213.25
B3024-188	Modified for 1 Wire Alternator		\$213.25
B3024-236	Modified for Delco 10SI Alternator (3 Wire)		\$213.25
B3024-365	Basic Wire Harness , Modified for a 1 Wire Alternator, Made with Modern PVC Wire & Nylon Braid		\$58.00

Wiring Harnesses, Battery Cables, & Spark Plug Wires, Proudly Made in the USA!

B3024-302	Rear Light Harness (2 Wire with Steel Conduit)	Replaces IHC/Farmall: #358915R91 (Included in Complete Wire Harnesses listed above)	\$46.50
B3024-303	Head Light Harness (2 Wire)	Replaces IHC/Farmall: #358916R91 (Included in Complete Wire Harnesses listed above)	\$42.00

IHC/Farmall Super MD (Serial #F501-F28174)(Serial #L500001-L504801)

Complete Wire Harness

B3024-036	Original Design with Generator & Voltage Regulator	Replaces IHC/Farmall: #52973D, 52973DA, 62504D, 62505D, 355703R91	\$200.25
B3024-249	Modified for 1 Wire Alternator		\$200.25
B3024-305	Rear Light Harness (1 Wire with Steel Conduit)	Replaces IHC/Farmall: #358121R91 (Included in Complete Wire Harnesses listed above)	\$37.25

Head Light Harness

B3024-304	Original Type made with Correct Cotton Braid Wire & Original Type Braided Sheath (1 Wire)	Replaces IHC/Farmall: #52973DA (Included in Complete Wire Harnesses listed above)	\$31.75
B3024-304M	Modern Type- as #B3024-304, but made with PVC Wire	Replaces IHC/Farmall: #52973DA	\$19.75

IHC/Farmall Super MD , & Super MDTA (Serial #F28175 & Up)(Serial #L504802 & Up)

Complete Wire Harness

B3024-046	Original Design with Generator & Voltage Regulator		\$213.25
B3024-363	Modified for 1 Wire Alternator		\$213.25
B3024-364	Modified for 10SI (3 Wire) Alternator		\$213.25
B3024-302	Rear Light Harness (2 Wire with Steel Conduit)	Replaces IHC/Farmall: #358915R91 (Included in Complete Wire Harnesses listed above)	\$46.50
B3024-303	Head Light Harness (2 Wire)	Replaces IHC/Farmall: #358916R91 (Included in Complete Wire Harnesses listed above)	\$42.00

IHC/Farmall O4

Complete Wire Harness

B3024-028	Original Design with Generator & Cutout Relay		\$200.25
B3024-029	Original Design with Generator & Voltage Regulator		\$200.25
B3024-250	Original Design with Voltage Regulator Mounted on the Generator		\$200.25
B3024-383	Modified for 1 Wire Alternator		\$200.25

IHC/Farmall OS4

Complete Wire Harness

B3024-029	Original Design with Generator & Voltage Regulator		\$200.25
B3024-250	Original Design with Voltage Regulator Mounted on the Generator		\$200.25
B3024-383	Modified for 1 Wire Alternator		\$200.25

IHC/Farmall O6 (Serial #501-36,779)

Complete Wire Harness

B3024-053	Original Design with Generator & Cutout Relay		\$200.25
B3024-287	Modified for 1 Wire Alternator		\$200.25
B3024-292	Original Design with Generator & Cutout Relay Made With Modern PVC Wire & Nylon Braid		\$200.25

IHC/Farmall O6 (Serial #36,780 & Up)

Complete Wire Harness

B3024-054	Original Design with Generator & Voltage Regulator		\$200.25
B3024-334	Modified for 1 Wire Alternator		\$200.25

IHC/Farmall OS6

Complete Wire Harness

B3024-054	Original Design with Generator & Voltage Regulator		\$200.25
B3024-334	Modified for 1 Wire Alternator		\$200.25

IHC/Farmall ODS6 (Up to Serial #31,252)

B3024-057	Complete Wire Harness Original Design with Generator & Cutout Relay		\$200.25
------------------	---	--	-----------------

IHC/Farmall ODS6 (Serial #31,253 & Up)

B3024-058	Complete Wire Harness Original Design with Generator & Voltage Regulator		\$200.25
------------------	--	--	-----------------

IHC/Farmall T6

Complete Wire Harness

B3024-061	Original Design with Generator & Cutout Relay (On Radiator)		\$227.00
B3024-277	Modified for 1 Wire Alternator		\$227.00
B3024-060	Original Design with Generator & Voltage Regulator (On Dash)		\$227.00

IHC/Farmall TD6

Complete Wire Harness

B3024-061	Original Design with Generator & Cutout Relay (On Radiator)		\$227.00
B3024-277	Modified for 1 Wire Alternator		\$227.00
B3024-062	Original Design with Generator & Voltage Regulator (On Dash)		\$227.00

IHC/Farmall TD9 (Serial #501-46,709)

B3024-063	Complete Wire Harness Original Design with Generator & Cutout Relay (On Radiator)		\$227.00
------------------	---	--	-----------------

IHC/Farmall TD9 (Serial # 46,710 & Up)

B3024-064	Complete Wire Harness Original Design with Generator & Voltage Regulator (On Dash)		\$227.00
------------------	--	--	-----------------

IHC W4

Complete Wire Harness

B3024-065	Original Design with Generator & Cutout Relay		\$193.50
B3024-066	Original Design with Generator & Voltage Regulator		\$193.50
B3024-278	Modified for 1 Wire Alternator		\$193.50
B3024-242	Modified for Delco 10SI Alternator (3 Wire)		\$193.50

IHC Super W4

B3024-171	Complete Wire Harness Original Design with Generator & Voltage Regulator		\$213.25
------------------	--	--	-----------------

IHC W6 (Serial #501-29,473)

Complete Wire Harness

B3024-067	Original Design with Generator & Cutout Relay		\$200.75
B3024-202	Original Design with Voltage Regulator Mounted on the Generator		\$200.75
B3024-198	Modified for Delco 10SI Alternator (3 Wire)		\$200.75
B3024-281	Modified for 1 Wire Alternator		\$200.75

IHC W6 (Serial #29,474-36,779)

B3024-201	Complete Wire Harness Original Design with Generator & Cutout Relay		\$193.50
------------------	---	--	-----------------

IHC W6 (Serial #36,780 & Up)

Complete Wire Harness

B3024-068	Original Design with Generator & Voltage Regulator		\$200.75
B3024-200	Modified for 1 Wire Alternator		\$200.75

IHC Super W6 (up to Serial #3.950)

Complete Wire Harness

B3024-068	Original Design with Generator & Voltage Regulator		\$200.75
B3024-200	Modified for 1 Wire Alternator		\$200.75

IHC Super W6 (Serial #3951 to 9084)

B3024-386	Complete Wire Harness Original Design with Generator & Voltage Regulator		\$200.75
------------------	--	--	-----------------

IHC Super W6 (Serial #10,000 & Up)

Complete Wire Harness

B3024-070	Original Design with Generator & Voltage Regulator		\$200.75
B3024-245	Modified for 1 Wire Alternator		\$200.75
B3024-244	Modified for Delco 10SI Alternator (3 Wire)		\$200.75

IHC/Farmall WD6 (Serial #501-31,252)

Complete Wire Harness

B3024-312	Original Design with Generator & Cutout Relay		\$227.00
B3024-071	Original Design with Generator & Voltage Regulator		\$227.00
B3024-379	Modified for 1 Wire Alternator		\$227.00

IHC/Farmall WD6 (Serial #31,253 & Up)

Complete Wire Harness

B3024-312	Original Design with Generator & Cutout Relay		\$227.00
B3024-072	Original Design with Generator & Voltage Regulator		\$227.00
B3024-379	Modified for 1 Wire Alternator		\$227.00

IHC/Farmall SWD6 (Serial #501-10,000)

B3024-072	Complete Wire Harness Original Design with Generator & Voltage Regulator		\$227.00
------------------	--	--	-----------------

IHC/Farmall SWD6 (Serial #10,001 & Up)

B3024-073	Complete Wire Harness Original Design		\$227.00
------------------	---	--	-----------------

IHC/Farmall W9

Complete Wire Harness

B3024-074	Original Design with Generator & Cutout Relay		\$213.25
B3024-074M	Original Design with Generator & Cutout Relay Made with PVC Wire & Nylon Braid		\$213.25
B3024-075	Original Design with Generator & Voltage Regulator		\$213.25
B3024-235	Modified for Voltage Regulator Mounted on the Generator		\$213.25
B3024-251	Modified for 1 Wire Alternator		\$213.25
B3024-252	Modified for Delco 10SI Alternator (3 Wire)		\$213.25

IHC/Farmall WR9

B3024-199	Complete Wire Harness Original Design with Generator & Voltage Regulator		\$255.00
------------------	--	--	-----------------

IHC/Farmall WD9 (Serial #501-52,066)

Complete Wire Harness

B3024-076	Original Design with Generator & Cutout Relay		\$213.25
B3024-158	Modified for Voltage Regulator Mounted on the Generator		\$213.25

IHC/Farmall WD9 (Serial #52,067 & Up)

Complete Wire Harness

B3024-077	Original Design with Generator & Voltage Regulator		\$213.25
B3024-253	Modified for Delco 10SI Alternator (3 Wire)		\$213.25
B3024-345	Modified for 1 Wire Alternator		\$213.25

IHC/Farmall Super WD9

B3024-078	Complete Wire Harness Original Design with Generator & Voltage Regulator		\$227.00
------------------	--	--	-----------------

IHC/International W400 Gas

Complete Wire Harness

B3024-175	Original Design with Generator & Voltage Regulator		\$269.00
B3024-388	Modified for a 1-Wire Alternator		\$269.00

IHC/International W400 Diesel

B3024-105	Complete Wire Harness	Original Design with Generator & Voltage Regulator		\$269.00
------------------	-----------------------	--	--	-----------------

IHC/International W450 Gas Late

B3024-346	Complete Wire Harness	Original Design with 12 Volt Generator & Voltage Regulator		\$269.00
------------------	-----------------------	--	--	-----------------

International 70 Gas (Gear Drive or Hydro)

B3024-262	Complete Wire Harness	Original Design with Alternator & Deluxe Fender Lighting		\$848.75
------------------	-----------------------	--	--	-----------------

Includes Listed Components Below and Can Be Purchased Separately

B3024-261	Main Harness	<u>Replaces IHC/Farmall: #65959C2</u> Front Main	\$377.25
B3024-260	Dash Harness	<u>Replaces IHC/Farmall: #405294R2</u> Dash	\$188.75
B3024-181	Deluxe Fender Harness	<u>Replaces IHC/Farmall: #405209R1, 405877R1, 533254R1, 533255R1, 533256R1</u> Deluxe Fender Harness	\$332.00

International Hydro 100 Diesel

B3024-221	Complete Wire Harness	Original Design with 10SI (Internal Regulator) Alternator & Deluxe Fender Lighting		\$902.00
------------------	-----------------------	--	--	-----------------

Includes Listed Components Below and Can Be Purchased Separately

B3024-178	Front Main Harness	<u>Replaces IHC/Farmall: #538995R1</u> Front Main	\$437.75
B3024-180	Dash Harness	<u>Replaces IHC/Farmall: #534367R1</u> Dash	\$182.75
B3024-181	Deluxe Fender Harness	<u>Replaces IHC/Farmall: #405209R1, 405877R1, 533254R1, 533255R1, 533256R1</u> Deluxe Fender Harness	\$332.00

IHC/Farmall 100

Complete Wire Harness

B3024-081	Original Design with Generator & Voltage Regulator	<u>Replaces IHC/Farmall: #3634796R91, 358109R92, 363483R91</u>	\$200.25
B3024-172	Modified for 1 Wire Alternator	See #B3024-081	\$200.25
B3024-231	Modified for Delco 10SI Alternator (3 Wire)	See #B3024-081	\$200.25

McCormick-Deering 125 SPU Harvester (Combine)

B3024-394	Complete Wire Harness	Original Design with Regulator		\$195.00
------------------	-----------------------	--------------------------------	--	-----------------

IHC/Farmall 130

Complete Wire Harness

B3024-081	Original Design with Generator & Voltage Regulator	<u>Replaces IHC: #3634796R91, 358109R92, 363483R91</u>	\$200.25
B3024-172	Modified for 1 Wire Alternator	See #B3024-081	\$200.25
B3024-231	Modified for Delco 10SI Alternator (3 Wire)	See #B3024-081	\$200.25

IHC/Farmall 140 (Serial #501-2581)

Complete Wire Harness

B3024-343	Original Design with Generator & Voltage Regulator	<u>Replaces IHC/Farmall: #354232R91, (Fuse Housing); #357929R92, (Coil to Distributor Cable); #358109R92, (Ignition Harness); #358112R91, (Generator A Cable); #370816R91 (Main Harness); #370817R91, (Rear Light Harness); #370818R91, (Generator F Cable)</u>	\$227.00
B3024-371	Modified for 1 Wire Alternator	See B3024-343	\$227.00

IHC/Farmall 140 (Serial #2582-26,800)

Complete Wire Harness

B3024-084	Original Design with Generator & Voltage Regulator	<u>Replaces IHC/Farmall: #354232R91, (Fuse Housing); #357929R92, (Coil to Distributor Cable); #358109R92, (Ignition Harness); #370817R91, (Rear Light Harness); #373106R91, (Main Harness)</u>	\$227.00
B3024-217	Modified for 1 Wire Alternator	See B3024-084	\$227.00
B3024-248	Modified for Delco 10SI Alternator (3 Wire)	See B3024-084	\$227.00

IHC/Farmall 140 (Serial #26,801-45,000)

Complete Wire Harness

B3024-085	Original Design with Generator & Voltage Regulator	Replaces IHC/Farmall: #404351R91, 387318R91	\$227.00
B3024-227	Modified for 1 Wire Alternator	See #B3024-085	\$227.00

IHC/Farmall 140 (Serial #45,001-57,723)

Complete Wire Harness

B3024-086	Original Design with Generator & Voltage Regulator	Replaces IHC/Farmall: #547046R91, 387318R91, 547048R91, 547007R91	\$255.00
B3024-378	Modified for 1 Wire Alternator	Replaces IHC/Farmall: #547046R91, 387318R91, 547048R91, 547007R91	\$255.00

IHC/Farmall 140 (Serial #57,724-62,471)

Complete Wire Harness

B3024-087	Original Design with Alternator	Replaces IHC/Farmall: #68267C1, 387318R91, 547007R91	\$269.00
B3024-174	Modified for 1 Wire Alternator	See #B3024-087	\$269.00

IHC/Farmall 200

Complete Wire Harness

B3024-088	Original Design with Generator & Voltage Regulator	Replaces IHC/Farmall: #354243R92, 363486R91, 358916R92, 358109R92	\$200.25
B3024-170	Modified for 1 Wire Alternator	See #B3024-088	\$200.25
B3024-391	with Fast Hitch , Modified for 1 Wire Alternator	See #B3024-088	\$200.25
B3024-387	Modified for Delco 10SI Alternator (3 Wire)	See #B3024-088	\$200.25

IHC/Farmall 230

Complete Wire Harness

B3024-089	Original Design with Generator & Voltage Regulator	Replaces IHC/Farmall: #354243R92, 363486R91, 358916R92, 358109R92	\$200.25
B3024-167	Modified for 1 Wire Alternator	See #B3024-089	\$200.25

Farmall 240 Row Crop

Complete Wire Harness

B3024-090	Original Design with Generator & Voltage Regulator	Replaces IHC/Farmall: #370737R91, 370741R91, 370738R91	\$227.00
B3024-229	Modified for 1 Wire Alternator	See #B3024-090	\$227.00
B3024-230	Modified for Delco 10SI Alternator (3 Wire)	See #B3024-090	\$227.00

International 240 Utility (Serial #501-7,732)

Complete Wire Harness

B3024-091	Original Design with Generator & Voltage Regulator		\$269.00
B3024-344	Modified for 1 Wire Alternator		\$269.00
B3024-384	Modified for Delco 10SI Alternator (3 Wire)		\$269.00

International 240 Utility (Serial #7,733 & Up)

Complete Wire Harness

B3024-092	Original Design with Generator & Voltage Regulator		\$256.25
B3024-380	Modified for 1 Wire Alternator		\$256.25

Farmall 300 Gas Row Crop

Complete Wire Harness

B3024-093	Original Design with Generator & Voltage Regulator	Replaces IHC/Farmall: #362009R91 Instrument Light Lead; #362011R91 Light Switch to Head Light Lead; #362012R91 Rear Light & Break away Harness; #362019R91 Main Harness; #362669R92 Fuse Housing & Leads	\$255.00
B3024-168	Modified for Delco 10SI Alternator (3 Wire)	See #B3024-093	\$255.00
B3024-169	Modified for 1 Wire Alternator	See #B3024-093	\$255.00
B3024-393	Headlight Harness	(Included with Complete Harnesses above, #362011R91 Light Switch to Head Light Lead)	\$42.00

International 300 Gas Utility

Complete Wire Harness

B3024-095	Original Design with Generator & Voltage Regulator	Replaces IHC: #362011R91, 362019R91, 362015R92	\$255.00
B3024-239	Modified for 1 Wire Alternator	See #B3024-095	\$255.00
B3024-240	Modified for Delco 10SI Alternator (3 Wire)	See #B3024-095	\$255.00

International 330 Utility

Complete Wire Harness

B3024-096	Original Design with Generator & Voltage Regulator		\$255.00
B3024-173	Modified for Delco 10SI Alternator (3 Wire)		\$255.00
B3024-271	Modified for 1 Wire Alternator		\$255.00

Farmall 340 Gas Row Crop

Complete Wire Harness

B3024-098	Original Design with Generator & Voltage Regulator		\$255.00
B3024-280	Modified for 1 Wire Alternator		\$255.00
B3024-377	Modified for 10SI Alternator (3 Wire)		\$255.00

International Gas 340 Utility

Complete Wire Harness

B3024-097	Original Design with Generator & Voltage Regulator		\$255.00
B3024-216	Modified for 1 Wire Alternator		\$255.00
B3024-166	Modified for Delco 10SI Alternator (3 Wire)		\$255.00

Farmall 350 Gas Row Crop

Complete Wire Harness

B3024-099	Original Design with Generator & Voltage Regulator		\$255.00
B3024-263	Modified for 1 Wire Alternator		\$255.00
B3024-254	Modified for Delco 10SI Alternator (3 Wire)		\$255.00

International 350 Gas Utility

Early, 6- or 12-Volt with Push Button Start & 7-Wire Main Harness

Complete Wire Harness

B3024-095	Original Design w/ Generator & Voltage Regulator	Replaces IHC/Farmall: #366315R91 Main Harness	\$255.00
B3024-239	Modified for 1 Wire Alternator	See #B3024-095	\$255.00
B3024-240	Modified for Delco 10SI Alternator (3 Wire)	See #B3024-095	\$255.00

Late, 12-Volt with Key Start & 8-Wire Main Harness)

Complete Wire Harness

B3024-259	Original Design w/ Generator & Voltage Regulator	Replaces IHC/Farmall: #368884R91 Main Harness	\$269.00
B3024-331	Modified for Delco 10SI Alternator (3 Wire)	See #B3024-259	\$269.00
B3024-351	Modified for 1 Wire Alternator	See #B3024-259	\$269.00

Farmall 350 Diesel Row Crop

Complete Wire Harness

B3024-100	Original Design with Generator & Voltage Regulator		\$255.00
B3024-226	Modified for 1 Wire Alternator		\$255.00

International 350 Diesel Utility

B3024-234	Complete Wire Harness Original Design with Generator & Voltage Regulator		\$255.00
------------------	---	--	-----------------

IHC/Farmall 400 Gas

Complete Wire Harness

B3024-102	Original Design with Generator & Voltage Regulator	Replaces IHC/Farmall: #362011R91, Head Light Harness; #362669R91, Fuse Holder; #362007R91, & #365758R91, Main Harness; #362012R92, Rear Light Harness	\$255.00
B3024-219	(12-Volt) Modified for 1 Wire Alternator	See #B3024-102	\$255.00
B3024-220	(12-Volt) Modified for Delco 10SI Alternator (3 Wire)	See #B3024-102	\$255.00

IHC/Farmall 400 Diesel

Complete Wire Harness

B3024-103	Original Design with Generator & Voltage Regulator		\$269.00
B3024-238	Modified for 1 Wire Alternator		\$269.00

Farmall B404, 404 Row Crop with Cowl-Mounted Lights

B3024-106	Complete Wire Harness Original Design with Generator & Voltage Regulator		\$447.00
------------------	--	--	-----------------

IHC/Farmall 450 Gas (Serial #501-11,083) Key Start

Complete Wire Harness

B3024-102	Original Design with Generator & Voltage Regulator	Replaces IHC/Farmall: #362011R91, Head Light Harness; #362669R91, Fuse Holder; #362007R91, & #365758R91, Main Harness; #362012R92, Rear Light Harness	\$255.00
B3024-219	Modified for 1 Wire Alternator	See #B3024-102	\$255.00
B3024-220	Modified for Delco 10SI Alternator (3 Wire)	See #B3024-102	\$255.00

IHC/Farmall 450 Gas (Serial #11,084 & Up) Push Button Start

Complete Wire Harness

B3024-108	Original Design with Generator & Voltage Regulator	Replaces IHC/Farmall: #362011R91 Head Light Harness; #362669R91 Fuse Holder; #362007R91 & 365758R91 Main Harness; #362012R92 Rear Light Harness	\$269.00
B3024-165	Modified for 1 Wire Alternator	See #B3024-108	\$269.00
B3024-164	Modified for Delco 10SI Alternator (3 Wire)	See #B3024-108	\$269.00

IHC/Farmall 450 Diesel (Serial #501-13,490)

B3024-109	Complete Wire Harness Original Design with Generator & Voltage Regulator		\$255.00
------------------	--	--	-----------------

IHC/Farmall 450 Diesel (Serial #13,491 & Up)

Complete Wire Harness

B3024-110	Original Design with Generator & Voltage Regulator		\$269.00
B3024-284	Modified for 1 Wire Alternator		\$269.00

Farmall 460 Gas Row Crop

Complete Wire Harness

B3024-115	Original Design with Generator & Voltage Regulator		\$391.25
B3024-211	Modified for 1 Wire Alternator		\$391.25
B3024-212	Modified for Delco 10SI Alternator (3 Wire)		\$391.25

International 460 Gas Utility

Complete Wire Harness

B3024-113	Original Design with Generator & Voltage Regulator		\$391.25
B3024-373	Modified for 1 Wire Alternator		\$391.25

Farmall 460 Diesel Row Crop

Complete Wire Harness

B3024-111	Original Design with Generator & Voltage Regulator	Replaces IHC/Farmall: #319965R91, 370386R91, 395077R91, 370395R91, 376102R91, 370437R92	\$391.25
B3024-213	Modified for 1 Wire Alternator	See #B3024-111	\$391.25
B3024-214	Modified for Delco 10SI Alternator (3 Wire)	See #B3024-111	\$391.25
B3024-368	Glow Plug Harness (Included in Complete Harnesses above)	Replaces IHC/Farmall: #319965R91 (2 used per Tractor)	\$23.50

IHC 460 Diesel Utility

Complete Wire Harness

B3024-330	Original Design with Generator & Voltage Regulator	Replaces IHC/Farmall: #319965R91	\$514.50
B3024-313	Modified for Delco 10SI Alternator (3 Wire)		\$514.50
B3024-368	Glow Plug Harness (Included in Complete Harnesses above)	Replaces IHC/Farmall: #319965R91 (2 used per Tractor)	\$23.50

Farmall 504 Gas Row Crop with Cowl Mounted Lights

Complete Wire Harness

B3024-325	Original Design with Generator & Voltage Regulator		\$485.00
B3024-327	Modified for Delco 10SI Alternator (3 Wire)		\$485.00

Includes Listed Components Below and Can Be Purchased Separately

Front Main Harness

B3024-322	Original Design with Generator & Voltage Regulator	Replaces IHC/Farmall: #377108R1, #393550R1 Main Harness, #376868R91 Voltage Regulator Harness	\$224.25
B3024-326	Modified for Delco 10SI Alternator (3 Wire)	Replaces IHC/Farmall: #377108R1, #393550R1 Main Harness, #376868R91 Voltage Regulator Harness	\$224.25
B3024-323	Dash Harness	Replaces IHC/Farmall: #381661R91 Dash Harness	\$149.00
B3024-324	Cowl Lighting Harness	Replaces IHC/Farmall: #376870R91 Cowl Lighting Harness; #374490R91 Headlight Ground Harness	\$54.75
B3024-328	Rear Lighting Harness	Replaces IHC/Farmall: #377117R91 Rear Lighting Harness; #391243R91 Combination Rear Light Harness	\$68.75

Farmall 504 Gas Row Crop with Deluxe Fender Mounted Lights

Complete Wire Harness

B3024-355	Original Design with Generator & Voltage Regulator		\$485.00
B3024-356	Modified for Delco 10SI Alternator (3 Wire)		\$485.00

Includes Listed Components Below and Can Be Purchased Separately

Front Main Harness

B3024-322	Original Design with Generator & Voltage Regulator	Replaces IHC/Farmall: #377108R1, #393550R1 Main Harness, #376868R91 Voltage Regulator Harness	\$224.25
B3024-326	Modified for Delco 10SI Alternator (3 Wire)	Replaces IHC/Farmall: #377108R1, #393550R1 Main Harness, #376868R91 Voltage Regulator Harness	\$224.25
B3024-323	Dash Harness	Replaces IHC/Farmall: #381661R91 Dash Harness	\$149.00
B3024-354	Deluxe Fender Mounted Lighting Harness	Replaces IHC/Farmall: #388949R1 Fender Harness, 2 Used; #374490R91 Headlight Ground Harness & 391214R91 Intermediate Harness	\$188.75

Farmall 504 Diesel Row Crop with Cowl Mounted Lights

Complete Wire Harness

B3024-357	Original Design with Generator & Voltage Regulator		\$485.00
B3024-375	Modified for a 10SI Alternator		\$485.00

Includes Listed Components Below and Can Be Purchased Separately

Front Main Harness

B3024-352	Original Design with Generator & Voltage Regulator	Replaces IHC/Farmall: #377109R1 , Main Harness, #376868R91 Voltage Regulator Harness, & #319966R91 Glow Plug Harness	\$224.25
B3024-374	Modified for a 10SI Alternator	Replaces IHC/Farmall: #377109R1 , Main Harness, #376868R91 Voltage Regulator Harness, & #319966R91 Glow Plug Harness	\$224.25
B3024-353	Dash Harness	Replaces IHC/Farmall: #381662R91 Dash Harness	\$149.00
B3024-324	Cowl Lighting Harness	Replaces IHC/Farmall: #376870R91 Cowl Lighting Harness; #374490R91 Headlight Ground Harness	\$54.75
B3024-328	Rear Lighting Harness	Replaces IHC/Farmall: #377117R91 Rear Lighting Harness; #391243R91 Combination Rear Light Harness	\$68.75

Farmall 504 Diesel Row Crop with Deluxe Fender Mounted Lights

Complete Wire Harness

B3024-358	Original Design with Generator & Voltage Regulator		\$497.00
B3024-376	Modified for a 10SI Alternator		\$497.00

Includes Listed Components Below and Can Be Purchased Separately

Front Main Harness

B3024-352	Original Design with Generator & Voltage Regulator	Replaces IHC/Farmall: #377109R1 , Main Harness, #376868R91 Voltage Regulator Harness, & #319966R91 Glow Plug Harness	\$224.25
B3024-374	Modified for a 10SI Alternator	Replaces IHC/Farmall: #377109R1 , Main Harness, #376868R91 Voltage Regulator Harness, & #319966R91 Glow Plug Harness	\$224.25
B3024-353	Dash Harness	Replaces IHC/Farmall: #381662R91 Dash Harness	\$149.00
B3024-354	Deluxe Fender Mounted Lighting Harness	Replaces IHC/Farmall: #388949R1 Fender Harness, 2 Used; #374490R91 Headlight Ground Harness & 391214R91 Intermediate Harness	\$188.75

International 504 Gas Utility

Complete Wire Harness

B3024-267	Original Design with Generator & Voltage Regulator		\$630.50
B3024-382	Modified for 10SI Alternator		\$630.50

Includes Listed Components Below and Can Be Purchased Separately

Engine & Regulator Harness

B3024-264	Original Design with Generator & Voltage Regulator	Replaces IHC/Farmall: #393552R91 Engine harness; #376868R91 Voltage Regulator Harness	\$228.25
B3024-381	Modified for 10SI Alternator	Replaces IHC/Farmall: #393552R91 Engine harness; #376868R91 Voltage Regulator Harness	\$228.25
B3024-265	Dash Harness	Replaces IHC/Farmall: #380400R91 Dash Harness	\$188.75
B3024-266	Lighting Harness	Replaces IHC/Farmall: #376869R91, 377298R91, 377299R91, 377300R91, 377301R91, 381543R91 Lighting Kit	\$225.75

Farmall 560 Gas Row Crop

Complete Wire Harness

B3024-115	Original Design with Generator & Voltage Regulator		\$391.25
B3024-211	Modified for 1 Wire Alternator		\$391.25
B3024-212	Modified for Delco 10SI Alternator (3 Wire)		\$391.25

International 560 Gas Utility

Complete Wire Harness

B3024-113	Original Design with Generator & Voltage Regulator		\$391.25
B3024-373	Modified for 1 Wire Alternator		\$391.25

Farmall 560 Diesel Row Crop

Complete Wire Harness

B3024-111	Original Design with Generator & Voltage Regulator	Replaces IHC/Farmall: #319965R91, 370386R91, 395077R91, 370395R91, 376102R91, 370437R92	\$391.25
B3024-213	Modified for 1 Wire Alternator	See #B3024-111	\$391.25
B3024-214	Modified for Delco 10SI Alternator (3 Wire)	See #B3024-111	\$391.25
B3024-368	Glow Plug Harness (Included in Complete Harnesses above)	Replaces IHC/Farmall: #319965R91 (2 used per Tractor)	\$23.50

IHC 560 Diesel Utility

Complete Wire Harness

B3024-330	Original Design with Generator & Voltage Regulator	Replaces IHC/Farmall: #319965R91	\$514.50
B3024-313	Modified for Delco 10SI Alternator (3 Wire)		\$514.50
B3024-368	Glow Plug Harness (Included in Complete Harnesses above)	Replaces IHC/Farmall: #319965R91 (2 used per Tractor)	\$23.50

IHC/Farmall 600 Diesel

B3024-078	Complete Wire Harness Original Design with Generator & Voltage Regulator		\$227.00
------------------	--	--	-----------------

IHC/Farmall 606 Gas or Diesel

B3024-129	Deluxe Fender Wire Harness Original Design	Replaces IHC/Farmall: #388948R1, 388949R1 (2 Used), 394130R91, 394265R91 Deluxe Fender Harness	\$196.75
------------------	--	---	-----------------

Farmall 656 Gas Row Crop (Up to Serial #23,107) with Deluxe Fender Lighting

Complete Wire Harness

B3024-272	Original Design with Generator		\$831.25
B3024-367	Modified for Delco 10SI Alternator (3 Wire)	*Note: May Be Used With A 1 Wire Alternator, Except The Charge Indicator Lamp Will Not Work!	\$831.25

Includes Listed Components Below and Can Be Purchased Separately

Front Main Harness

B3024-273	Original Design with Generator	Replaces IHC/Farmall: #389022R91, 393557R91 Front Main	\$177.25
B3024-366	Modified for Delco 10SI Alternator (3 Wire)	Same as #B3024-273	\$177.25
B3024-279	Rear Main Harness (Deluxe Fender Lighting)	Replaces IHC/Farmall: #528735R93, #535872R1 Rear Main	\$303.75
B3024-127	Right Dash Harness	Replaces IHC/Farmall: #405251R2 Right Dash	\$135.25
B3024-128	Left Dash Harness	Replaces IHC/Farmall: #405250R1 Left Dash	\$82.75
B3024-135	Deluxe Fender Harness	Replaces IHC/Farmall: #388949R1 (2 Pieces), 403302R1, 404393R1, 405287R1, 405876R1 Deluxe Fender Harness	\$209.50
B3024-389	Rear Main Harness (Cowl Mounted Lighting)	Replaces IHC/Farmall: #528735R93, 405284R1 Rear Main	\$333.75
B3024-390	Cowl Lighting Harness	Replaces IHC/Farmall: #405209R1, 370387R1, 405228R1, 383594RR91 Cowl Lighting Harness	\$33.50

Farmall 656 Gas Row Crop (Serial #23,108 & Up) with Deluxe Fender Lighting

Complete Wire Harness

B3024-119	Original Design with 10DN Alternator		\$831.25
B3024-301	Modified for Delco 10SI Alternator (3 Wire) (Can be used with early serial # tractors)		\$831.25

Includes Listed Components Below and Can Be Purchased Separately

Front Main Harness

B3024-228	Original Design with 10DN Alternator	Replaces IHC/Farmall: #405270R1 Front Main	\$177.25
B3024-300	Modified for Delco 10SI Alternator (3 Wire) (Can be used with early serial # tractors)	Replaces IHC/Farmall: #405270R1 Front Main	\$177.25
B3024-279	Rear Main Harness	Replaces IHC/Farmall: #528735R93, #535872R1 Rear Main	\$303.75
B3024-127	Right Dash Harness	Replaces IHC/Farmall: #405251R2 Right Dash	\$135.25
B3024-128	Left Dash Harness	Replaces IHC/Farmall: #405250R1 Left Dash	\$82.75
B3024-135	Deluxe Fender Harness	Replaces IHC/Farmall: #388949R1 (2 Pieces), 403302R1, 404393R1, 405287R1, 405876R1 Deluxe Fender Harness	\$209.50

Farmall 656 Diesel (Up to Serial #23,108) with Deluxe Fender Lighting

B3024-342	Complete Wire Harness Original Design with Generator & Regulator		\$761.50
------------------	--	--	-----------------

Includes Listed Components Below and Can Be Purchased Separately

B3024-340	Front Main Harness Original Design with Generator & Regulator	Replaces IHC/Farmall: #389025R91 Front Main	\$115.25
B3024-341	Rear Main Harness	Replaces IHC/Farmall: #389089R91 Rear Main	\$263.25
B3024-127	Right Dash Harness	Replaces IHC/Farmall: #405251R2 Right Dash	\$135.25
B3024-128	Left Dash Harness	Replaces IHC/Farmall: #405250R1 Left Dash	\$82.75
B3024-135	Deluxe Fender Harness	Replaces IHC/Farmall: #388949R1 (2 Pieces), 403302R1, 404393R1, 405287R1, 405876R1 Deluxe Fender Harness	\$209.50
B3024-368	Glow Plug Harness (Included in Complete Harnesses above)	Replaces IHC/Farmall: #319965R91 (2 used per Tractor)	\$23.50

Farmall 656 Diesel (Serial #23,109 & Up) with Deluxe Fender Lighting

Complete Wire Harness

B3024-196	Original Design with 10DN Alternator		\$877.75
B3024-315	Modified for Delco 10SI Alternator (3 Wire)		\$877.75

Includes Listed Components Below and Can Be Purchased Separately

Front Main Harness

B3024-197	Original Design with 10DN Alternator	Replaces IHC/Farmall: #405269R1 Front Main	\$177.25
B3024-314	Modified for Delco 10SI Alternator (3 Wire)	Replaces IHC/Farmall: #405269R1 Front Main	\$177.25
B3024-218	Rear Main Harness	Replaces IHC/Farmall: #528734R93, #535871R1 Rear Main, #402246R1 Rear Main to Glow Plug Meter	\$322.50

Wiring Harnesses, Battery Cables, & Spark Plug Wires, Proudly Made in the USA!

B3024-127	Right Dash Harness	Replaces IHC/Farmall: #405251R2 Right Dash	\$135.25
B3024-128	Left Dash Harness	Replaces IHC/Farmall: #405250R1 Left Dash	\$82.75
B3024-135	Deluxe Fender Harness	Replaces IHC/Farmall: #388949R1 (2 Pieces), 403302R1, 404393R1, 405287R1, 405876R1 Deluxe Fender Harness	\$209.50
B3024-368	Glow Plug Harness (Included in Complete Harnesses above)	Replaces IHC/Farmall: #319965R91 (2 used per Tractor)	\$23.50

IHC/Farmall 664 Diesel

B3024-122	Complete Wire Harness Original Design	Replaces IHC/Farmall: #406693R2	\$869.50
------------------	--	--	-----------------

International 666 Gas (Gear Drive or Hydro) with Deluxe Fender Lighting

B3024-262	Complete Wire Harness Original Design with Alternator		\$848.75
------------------	--	--	-----------------

Includes Listed Components Below and Can Be Purchased Separately

B3024-261	Front Main Harness	Replaces IHC/Farmall: #65959C2 Front Main	\$377.25
B3024-260	Dash Harness	Replaces IHC/Farmall: #405294R2 Dash	\$188.75
B3024-181	Deluxe Fender Harness	Replaces IHC/Farmall: #4052209R1, 405877R1, 533254R1, 533255R1, 533256R1 Deluxe Fender Harness	\$332.00

International 666 Diesel (Gear Drive or Hydro) with Deluxe Fender Lighting

B3024-339	Complete Wire Harness Original Design with Alternator		\$848.75
------------------	--	--	-----------------

Includes Listed Components Below and Can Be Purchased Separately

B3024-338	Front Main Harness	Replaces IHC/Farmall: #65960C1 Front Main	\$377.25
B3024-260	Dash Harness	Replaces IHC/Farmall: #405294R2 Dash	\$188.75
B3024-181	Deluxe Fender Harness	Replaces IHC/Farmall: #4052209R1, 405877R1, 533254R1, 533255R1, 533256R1 Deluxe Fender Harness	\$332.00

Farmall 706 Gas with Deluxe Fender Lighting

Complete Wire Harness

B3024-124	Original Design with Generator		\$863.75
B3024-205	Original Design with 10DN Alternator (External Voltage Regulator)		\$863.75
B3024-362	Modified for 10SI Alternator (Internal Voltage Regulator)		\$863.75

Includes Listed Components Below and Can Be Purchased Separately

Front Main Harness

B3024-125	Original Design with Generator	Replaces IHC/Farmall: #384457R91, #385009R91, #393566R91 Front Main	\$182.75
B3024-209	Original Design with 10DN Alternator (External Voltage Regulator)	Replaces IHC/Farmall: #384552R1 Front Main	\$182.75
B3024-361	Modified for 10SI Alternator (Internal Voltage Regulator)	Replaces IHC/Farmall: #384552R1 Front Main	\$182.75

Rear Main Harness

B3024-126	Original Design with Generator	Replaces IHC/Farmall: #384456R91, #385010R91 Rear Main	\$317.75
B3024-210	Original Design with 10DN Alternator (External Voltage Regulator) & 10SI Modification (Internal Voltage Regulator)	Replaces IHC/Farmall: #384999R91, #385010R91 Rear Main	\$317.75

B3024-127	Right Dash Harness	Replaces IHC/Farmall: #405251R2 Right Dash	\$135.25
B3024-128	Left Dash Harness	Replaces IHC/Farmall: #405250R1 Left Dash	\$82.75
B3024-129	Deluxe Fender Harness	Replaces IHC/Farmall: #388948R1, 388949R1 (2 Used), 394130R91, 394265R91 Deluxe Fender Harness	\$196.75

Farmall 706 Diesel (Up to Serial #37,236) with Deluxe Fender Lighting

Complete Wire Harness

B3024-204	Original Design with Generator		\$921.75
B3024-296	Original Design with 10DN Alternator		\$921.75
B3024-350	Modified for Delco 10SI Alternator (3 Wire)		\$921.75

Includes Listed Components Below and Can Be Purchased Separately

Front Main Harness

B3024-359	Original Design with Generator	Replaces IHC/Farmall: #384460R91 Front Main	\$182.75
B3024-294	Original Design with 10DN Alternator	Replaces IHC/Farmall: #385000R91 Front Main	\$182.75
B3024-349	Modified for Delco 10SI Alternator (3 Wire)	Replaces IHC/Farmall: #385000R91 Front Main	\$182.75

Rear Main Harness

B3024-360	Original Design with Generator	Replaces IHC/Farmall: #384459R91 Rear Main	\$317.75
B3024-295	For Both 10DN Alternator & Delco 10SI Alternator (3 Wire)	Replaces IHC/Farmall: #385001R91 Rear Main	\$317.75
B3024-297	Glow Plug Dash Harness	Replaces IHC/Farmall: #375077R91 Glow plug Meter to Glow Plug Switch; #384458R91 Rear Harness to Glow plug Meter	\$61.75
B3024-127	Right Dash Harness	Replaces IHC/Farmall: #405251R2 Right Dash	\$135.25
B3024-128	Left Dash Harness	Replaces IHC/Farmall: #405250R1 Left Dash	\$82.75
B3024-129	Deluxe Fender Harness	Replaces IHC/Farmall: #388948R1, 388949R1 (2 Used), 394130R91, 394265R91 Deluxe Fender Harness	\$196.75
B3024-368	Glow Plug Harness (Included in Complete Harnesses above)	Replaces IHC/Farmall: #319965R91 (2 used per Tractor)	\$23.50

Farmall 706 Diesel (Serial #37,237 & Up) **with Deluxe Fender Lighting**

Complete Wire Harness

B3024-203	Original Design with 10DN Alternator		\$863.75
B3024-336	Modified for Delco 10SI Alternator (3 Wire)		\$863.75

Includes Listed Components Below and Can Be Purchased Separately

Front Main Harness

B3024-191	Original Design with 10DN Alternator	Replaces IHC/Farmall: #398556R1 or 385011R91 Front Main	\$182.75
B3024-335	Modified for Delco 10SI Alternator (3 Wire)	Replaces IHC/Farmall: #398556R1 or 385011R91 Front Main	\$182.75
B3024-192	Rear Main Harness	Replaces IHC/Farmall: #385012R91 Rear Main	\$317.75
B3024-127	Right Dash Harness	Replaces IHC/Farmall: #405251R2 Right Dash	\$135.25
B3024-128	Left Dash Harness	Replaces IHC/Farmall: #405250R1 Left Dash	\$82.75
B3024-129	Deluxe Fender Harness	Replaces IHC/Farmall: #388948R1, 388949R1 (2 Used), 394130R91, 394265R91 Deluxe Fender Harness	\$196.75

Farmall 756 Gas with Deluxe Fender Lighting

Complete Wire Harness

B3024-130	Original Design with 10DN Alternator		\$1003.50
B3024-333	Modified for Delco 10SI Alternator (3 Wire)		\$1003.50

Includes Listed Components Below and Can Be Purchased Separately

Front Main Harness

B3024-148	Original Design with 10DN Alternator	Replaces IHC/Farmall: #398916R1 Front Main	\$249.25
B3024-332	Modified for Delco 10SI Alternator (3 Wire)	Replaces IHC/Farmall: #398916R1 Front Main	\$249.25
B3024-132	Rear Main Harness	Replaces IHC/Farmall: #398915R1 Rear Main	\$357.50
B3024-133	Right Dash Harness	Replaces IHC/Farmall: #398923R1 Right Dash	\$143.25
B3024-134	Left Dash Harness	Replaces IHC/Farmall: #398923R1, 405274R1, 406121R1 Left Dash	\$102.50
B3024-135	Deluxe Fender Harness	Replaces IHC/Farmall: #388949R1, #404393R1, #405287R1, #405949R1 Deluxe Fender Harness	\$209.50

Farmall 756 Diesel with Deluxe Fender Lighting

Complete Wire Harness

B3024-136	Original Design with 10DN Alternator		\$979.00
B3024-309	Modified for Delco 10SI Alternator (3 Wire)		\$979.00

Includes Listed Components Below and Can Be Purchased Separately

Front Main Harness

B3024-137	Original Design with 10DN Alternator	Replaces IHC/Farmall: #398929R1, #405278R1 Front Main	\$223.50
B3024-307	Modified for Delco 10SI Alternator (3 Wire)	Replaces IHC/Farmall: #398929R1, #405278R1 Front Main	\$223.50
B3024-131	Rear Main Harness	Replaces IHC/Farmall: #405292R2 Rear Main	\$357.50

B3024-183	Right Dash Harness	Replaces IHC/Farmall: #398924R1, 405275R1, 528175R1 Right Dash	\$143.25
B3024-134	Left Dash Harness	Replaces IHC/Farmall: #398923R1, 405274R1, 406121R1 Left Dash	\$102.50
B3024-135	Deluxe Fender Harness	Replaces IHC/Farmall: #388949R1, #404393R1, #405287R1, #405949R1 Deluxe Fender Harness	\$209.50

Farmall 766 Gas (Up to Serial #7,404) with Deluxe Fender Lighting

B3024-232	Complete Wire Harness Original Design		\$960.25
------------------	---	--	-----------------

Includes Listed Components Below and Can Be Purchased Separately

B3024-233	Front Main Harness	Replaces IHC/Farmall: #534369R1 Front Main	\$498.25
B3024-180	Dash Harness	Replaces IHC/Farmall: #534367R1 Dash	\$182.75
B3024-181	Deluxe Fender Harness	Replaces IHC/Farmall: #4052209R1, 405877R1, 533254R1, 533255R1, 533256R1 Deluxe Fender Harness	\$332.00
B3024-370	Deluxe Cab Dash Harness (Sold Separately)	Replaces IHC/Farmall: #405221R1, 537051R1	\$222.50

Farmall 766 Gas (Serial #7,405 & Up) with Deluxe Fender Lighting

B3024-184	Complete Wire Harness Original Design		\$960.25
------------------	---	--	-----------------

Includes Listed Components Below and Can Be Purchased Separately

B3024-185	Front Main Harness	Replaces IHC/Farmall: #538996R1 Front Main	\$498.25
B3024-180	Dash Harness	Replaces IHC/Farmall: #534367R1 Dash	\$182.75
B3024-181	Deluxe Fender Harness	Replaces IHC/Farmall: #4052209R1, 405877R1, 533254R1, 533255R1, 533256R1 Deluxe Fender Harness	\$332.00
B3024-370	Deluxe Cab Dash Harness (Sold Separately)	Replaces IHC/Farmall: #405221R1, 537051R1	\$222.50

Farmall 766 Diesel with Deluxe Fender Lighting

B3024-182	Complete Wire Harness Original Design		\$902.00
------------------	---	--	-----------------

Includes Listed Components Below and Can Be Purchased Separately

B3024-178	Main Harness	Replaces IHC/Farmall: #405211R1, 538995R1 Main	\$437.75
B3024-180	Dash Harness	Replaces IHC/Farmall: #534367R1 Dash	\$182.75
B3024-181	Deluxe Fender Harness	Replaces IHC/Farmall: #4052209R1, 405877R1, 533254R1, 533255R1, 533256R1 Deluxe Fender Harness	\$332.00
B3024-370	Deluxe Cab Dash Harness (Sold Separately)	Replaces IHC/Farmall: #405221R1, 537051R1	\$222.50

Farmall 806 Gas with Deluxe Fender Lighting

Complete Wire Harness

B3024-153	Original Design with Generator		\$863.75
B3024-206	Original Design with 10DN Alternator (External Voltage Regulator)		\$863.75

Includes Listed Components Below and Can Be Purchased Separately

Front Main Harness

B3024-125	Original Design with Generator	Replaces IHC/Farmall: #384457R91, #385009R91, #393566R91 Front Main	\$182.75
B3024-209	Original Design with 10DN Alternator (External Voltage Regulator)	Replaces IHC/Farmall: #384552R1 Front Main	\$182.75

Rear Main Harness

B3024-126	Original Design with Generator	Replaces IHC/Farmall: #384456R91, #385010R91 Rear Main	\$317.75
B3024-210	Original Design with 10DN Alternator (Has External Voltage Regulator)	Replaces IHC/Farmall: #384999R91, #385010R91 Rear Main	\$317.75

B3024-127	Right Dash Harness	Replaces IHC/Farmall: #405251R2 Right Dash	\$135.25
B3024-128	Left Dash Harness	Replaces IHC/Farmall: #405250R1 Left Dash	\$82.75
B3024-129	Deluxe Fender Harness	Replaces IHC/Farmall: #388948R1, 388949R1 (2 Used), 394130R91, 394265R91 Deluxe Fender Harness	\$196.75

Farmall 806 Diesel (Generator) with Deluxe Fender Lighting

B3024-189	Complete Wire Harness Original Design with Generator		\$863.75
------------------	---	--	-----------------

Includes Listed Components Below and Can Be Purchased Separately

B3024-177	Front Main Harness	Replaces IHC/Farmall: #384469R91 Front Main	\$182.75
B3024-179	Rear Main Harness	Replaces IHC/Farmall: #384468R91 Rear Main	\$317.75
B3024-127	Right Dash Harness	Replaces IHC/Farmall: #405251R2 Right Dash	\$135.25
B3024-128	Left Dash Harness	Replaces IHC/Farmall: #405250R1 Left Dash	\$82.75
B3024-129	Deluxe Fender Harness	Replaces IHC/Farmall: #388948R1, 388949R1 (2 Used), 394130R91, 394265R91 Deluxe Fender Harness	\$196.75

Farmall 806 Diesel (Alternator) with Deluxe Fender Lighting

Complete Wire Harness

B3024-190	Original Design with 10DN Alternator (External Voltage Regulator)		\$863.75
B3024-337	Modified for Delco 10SI Alternator (3 Wire with Internal Regulator)		\$863.75

Includes Listed Components Below and Can Be Purchased Separately

Front Main Harness

B3024-191	Original Design with 10DN Alternator (External Voltage Regulator)	Replaces IHC/Farmall: #398556R1 or 385011R91 Front Main	\$182.75
B3024-335	Modified for Delco 10SI Alternator (3 Wire with Internal Regulator)	Replaces IHC/Farmall: #398556R1 or 385011R91 Front Main	\$182.75
B3024-192	Rear Main Harness	Replaces IHC/Farmall: #385012R91 Rear Main	\$317.75
B3024-127	Right Dash Harness	Replaces IHC/Farmall: #405251R2 Right Dash	\$135.25
B3024-128	Left Dash Harness	Replaces IHC/Farmall: #405250R1 Left Dash	\$82.75
B3024-129	Deluxe Fender Harness	Replaces IHC/Farmall: #388948R1, 388949R1 (2 Used), 394130R91, 394265R91 Deluxe Fender Harness	\$196.75

Farmall 826 Gas with Deluxe Fender Lighting

B3024-146	Complete Wire Harness Original Design		\$1003.50
------------------	---	--	------------------

Includes Listed Components Below and Can Be Purchased Separately

B3024-148	Front Main Harness	Replaces IHC/Farmall: #405277R1 Front Main	\$249.25
B3024-140	Rear Main Harness	Replaces IHC/Farmall: #405291R1 Rear Main	\$357.50
B3024-183	Right Dash Harness	Replaces IHC/Farmall: #398924R1, 405275R1, 528175R1 Right Dash	\$143.25
B3024-134	Left Dash Harness	Replaces IHC/Farmall: #398923R1, 405274R1, 406121R1 Left Dash	\$102.50
B3024-135	Deluxe Fender Harness	Replaces IHC/Farmall: #388949R1, #404393R1, #405287R1, #405949R1 Deluxe Fender Harness	\$209.50

Farmall 826 Diesel with Deluxe Fender Lighting

Complete Wire Harness

B3024-156	Original Design with 10DN Alternator		\$979.00
B3024-308	Modified for Delco 10SI Alternator (3 Wire)		\$979.00

Includes Listed Components Below and Can Be Purchased Separately

Front Main Harness

B3024-137	Original Design with 10DN Alternator	Replaces IHC/Farmall: #398929R1, #405278R1 Front Main	\$223.50
B3024-307	Modified for Delco 10SI Alternator (3 Wire)	Replaces IHC/Farmall: #398929R1, #405278R1 Front Main	\$223.50
B3024-131	Rear Main Harness	Replaces IHC/Farmall: #405292R2 Rear Main	\$357.50
B3024-183	Right Dash Harness	Replaces IHC/Farmall: #398924R1, 405275R1, 528175R1 Right Dash	\$143.25
B3024-134	Left Dash Harness	Replaces IHC/Farmall: #398923R1, 405274R1, 406121R1 Left Dash	\$102.50
B3024-135	Deluxe Fender Harness	Replaces IHC/Farmall: #388949R1, #404393R1, #405287R1, #405949R1 Deluxe Fender Harness	\$209.50

Farmall 856 Gas with Deluxe Fender Lighting

B3024-151	Complete Wire Harness Original Design		\$1003.50
------------------	---	--	------------------

Includes Listed Components Below and Can Be Purchased Separately

B3024-148	Front Main Harness	Replaces IHC/Farmall: #405277R1 Front Main	\$249.25
B3024-140	Rear Main Harness	Replaces IHC/Farmall: #405291R1 Rear Main	\$357.50
B3024-133	Right Dash Harness	Replaces IHC/Farmall: #398923R1 Right Dash	\$143.25

B3024-134	Left Dash Harness	Replaces IHC/Farmall: #398923R1, 405274R1, 406121R1 Left Dash	\$102.50
B3024-135	Deluxe Fender Harness	Replaces IHC/Farmall: #388949R1, #404393R1, #405287R1, #405949R1 Deluxe Fender Harness	\$209.50

Farmall 856 Diesel with Deluxe Fender Lighting

Complete Wire Harness

B3024-147	Original Design with 10DN Alternator		\$1001.25
B3024-310	Modified for Delco 10SI Alternator (3 Wire)		\$1001.25

Includes Listed Components Below and Can Be Purchased Separately

Front Main Harness

B3024-137	Original Design with 10DN Alternator	Replaces IHC/Farmall: #398929R1, #405278R1 Front Main	\$223.50
B3024-307	Modified for Delco 10SI Alternator (3 Wire)	Replaces IHC/Farmall: #398929R1, #405278R1 Front Main	\$223.50
B3024-131	Rear Main Harness	Replaces IHC/Farmall: #405292R2 Rear Main	\$357.50
B3024-183	Right Dash Harness	Replaces IHC/Farmall: #398924R1, 405275R1, 528175R1 Right Dash	\$143.25
B3024-134	Left Dash Harness	Replaces IHC/Farmall: #398923R1, 405274R1, 406121R1 Left Dash	\$102.50
B3024-291	Ether Assist Harness	Replaces IHC/Farmall: #395076R1 Ether Assist Harness	\$25.75
B3024-135	Deluxe Fender Harness	Replaces IHC/Farmall: #388949R1, #404393R1, #405287R1, #405949R1 Deluxe Fender Harness	\$209.50

Farmall 856 Diesel Custom with Deluxe Fender Lighting

Complete Wire Harness

B3024-320	Original Design		\$1001.25
B3024-321	Modified for Delco 10SI Alternator (3 Wire)		\$1001.25

Includes Listed Components Below and Can Be Purchased Separately

Front Main Harness

B3024-215	Original Design	Replaces IHC/Farmall: #405279R1 Front Main	\$223.50
B3024-316	Modified for Delco 10SI Alternator (3 Wire)	Replaces IHC/Farmall: #405279R1 Front Main	\$223.50
B3024-131	Rear Main Harness	Replaces IHC/Farmall: #405292R2 Rear Main	\$357.50
B3024-183	Right Dash Harness	Replaces IHC/Farmall: #398924R1, 405275R1, 528175R1 Right Dash	\$143.25
B3024-134	Left Dash Harness	Replaces IHC/Farmall: #398923R1, 405274R1, 406121R1 Left Dash	\$102.50
B3024-291	Ether Assist Harness	Replaces IHC/Farmall: #395076R1 Ether Assist Harness	\$25.75
B3024-135	Deluxe Fender Harness	Replaces IHC/Farmall: #388949R1, #404393R1, #405287R1, #405949R1 Deluxe Fender Harness	\$209.50

Farmall 966 Diesel (Up To Serial #11,683) with Deluxe Fender Lighting

B3024-270	Complete Wire Harness Original Design with 10DN Alternator (External Voltage Regulator)		\$902.00
------------------	---	--	-----------------

Includes Listed Components Below and Can Be Purchased Separately

B3024-288	Main Harness	Replaces IHC/Farmall: #534368R1 Main	\$437.75
B3024-180	Dash Harness	Replaces IHC/Farmall: #534367R1 Dash	\$182.75
B3024-181	Deluxe Fender Harness	Replaces IHC/Farmall: #4052209R1, 405877R1, 533254R1, 533255R1, 533256R1 Deluxe Fender Harness	\$332.00
B3024-370	Deluxe Cab Dash Harness (Sold Separately)	Replaces IHC/Farmall: #405221R1, 537051R1	\$222.50

Farmall 966 Diesel (Serial #11684 & Up) with Deluxe Fender Lighting

B3024-221	Complete Wire Harness Original Design with 10SI Alternator (3 Wire with Internal Regulator)		\$902.00
------------------	---	--	-----------------

Includes Listed Components Below and Can Be Purchased Separately

B3024-178	Main Harness	Replaces IHC/Farmall: #538995R1 Front Main	\$437.75
B3024-180	Dash Harness	Replaces IHC/Farmall: #534367R1 Dash	\$182.75
B3024-181	Deluxe Fender Harness	Replaces IHC/Farmall: #4052209R1, 405877R1, 533254R1, 533255R1, 533256R1 Deluxe Fender Harness	\$332.00
B3024-370	Deluxe Cab Dash Harness (Sold Separately)	Replaces IHC/Farmall: #405221R1, 537051R1	\$222.50

Farmall 1026 Diesel with Deluxe Fender Lighting

Complete Wire Harness

B3024-150	Original Design		\$1001.25
B3024-317	Modified for Delco 10SI Alternator (3 Wire)		\$1001.25

Includes Listed Components Below and Can Be Purchased Separately

Front Main Harness

B3024-215	Original Design	Replaces IHC/Farmall: #405279R1 Front Main	\$223.50
B3024-316	Modified for Delco 10SI Alternator (3 Wire)	Replaces IHC/Farmall: #405279R1 Front Main	\$223.50
B3024-131	Rear Main Harness	Replaces IHC/Farmall: #405292R2 Rear Main	\$357.50
B3024-183	Right Dash Harness	Replaces IHC/Farmall: #398924R1, 405275R1, 528175R1 Right Dash	\$143.25
B3024-134	Left Dash Harness	Replaces IHC/Farmall: #398923R1, 405274R1, 406121R1 Left Dash	\$102.50
B3024-291	Ether Assist Harness	Replaces IHC/Farmall: #395076R1 Ether Assist Harness	\$25.75
B3024-135	Deluxe Fender Harness	Replaces IHC/Farmall: #388949R1, #404393R1, #405287R1, #405949R1 Deluxe Fender Harness	\$209.50

Farmall 1066 Diesel (Up to Serial #12,509) with Deluxe Fender Lighting

B3024-269	Complete Wire Harness Original Design with 10DN Alternator (External Voltage Regulator)		\$902.00
------------------	---	--	-----------------

Includes Listed Components Below and Can Be Purchased Separately

B3024-288	Main Harness	Replaces IHC/Farmall: #534368R1 Main	\$437.75
B3024-180	Dash Harness	Replaces IHC/Farmall: #534367R1 Dash	\$182.75
B3024-181	Deluxe Fender Harness	Replaces IHC/Farmall: #4052209R1, 405877R1, 533254R1, 533255R1, 533256R1 Deluxe Fender Harness	\$332.00
B3024-370	Deluxe Cab Dash Harness (Sold Separately)	Replaces IHC/Farmall: #405221R1, 537051R1	\$222.50

Farmall 1066 Diesel (Serial #12,510 & Up) with Deluxe Fender Lighting

B3024-222	Complete Wire Harness Original Design with 10SI Alternator (3 Wire with Internal Regulator)		\$902.00
------------------	---	--	-----------------

Includes Listed Components Below and Can Be Purchased Separately

B3024-178	Main Harness	Replaces IHC/Farmall: #538995R1 Front Main	\$437.75
B3024-180	Dash Harness	Replaces IHC/Farmall: #534367R1 Dash	\$182.75
B3024-181	Deluxe Fender Harness	Replaces IHC/Farmall: #4052209R1, 405877R1, 533254R1, 533255R1, 533256R1 Deluxe Fender Harness	\$332.00
B3024-370	Deluxe Cab Dash Harness (Sold Separately)	Replaces IHC/Farmall: #405221R1, 537051R1	\$222.50

Farmall 1206 Diesel with Deluxe Fender Lighting

Complete Wire Harness

B3024-143	Original Design with 10DN Alternator (External Voltage Regulator)		\$963.75
B3024-348	Modified for Delco 10SI Alternator (3 Wire with Internal Regulator)		\$963.75

Includes Listed Components Below and Can Be Purchased Separately

Front Main Harness

B3024-144	Original Design with 10DN Alternator (External Voltage Regulator)	Replaces IHC/Farmall: #398549R1 Front Main	\$249.25
B3024-347	Modified for Delco 10SI Alternator (3 Wire with Internal Regulator)	Replaces IHC/Farmall: #398549R1 Front Main	\$249.25
B3024-145	Rear Main Harness	Replaces IHC/Farmall: #392442R91 Rear Main	\$317.75
B3024-127	Right Dash Harness	Replaces IHC/Farmall: #405251R2 Right Dash	\$135.25
B3024-128	Left Dash Harness	Replaces IHC/Farmall: #405250R1 Left Dash	\$82.75
B3024-291	Ether Assist Harness	Replaces IHC/Farmall: #395076R1 Ether Assist Harness	\$25.75
B3024-129	Deluxe Fender Harness	Replaces IHC/Farmall: #388948R1, 388949R1 (2 Used), 394130R91, 394265R91 Deluxe Fender Harness	\$196.75

Farmall 1256 Diesel with Deluxe Fender Lighting

Complete Wire Harness

B3024-149	Original Design with 10DN Alternator (External Voltage Regulator)		\$1001.25
B3024-318	Modified for Delco 10SI Alternator (3 Wire)		\$1001.25

Includes Listed Components Below and Can Be Purchased Separately

Front Main Harness

B3024-215	Original Design with 10DN Alternator (External Voltage Regulator)	Replaces IHC/Farmall: #405279R1 Front Main	\$223.50
B3024-316	Modified for Delco 10SI Alternator (3 Wire)	Replaces IHC/Farmall: #405279R1 Front Main	\$223.50
B3024-131	Rear Main Harness	Replaces IHC/Farmall: #405292R2 Rear Main	\$357.50
B3024-183	Right Dash Harness	Replaces IHC/Farmall: #398924R1, 405275R1, 528175R1 Right Dash	\$143.25
B3024-134	Left Dash Harness	Replaces IHC/Farmall: #398923R1, 405274R1, 406121R1 Left Dash, #383620R91 Dash Lamp Socket (2 Included)	\$102.50
B3024-291	Ether Assist Harness	Replaces IHC/Farmall: #395076R1 Ether Assist Harness	\$25.75
B3024-135	Deluxe Fender Harness	Replaces IHC/Farmall: #388949R1, #404393R1, #405287R1, #405949R1 Deluxe Fender Harness	\$209.50

Farmall 1456 Diesel with Deluxe Fender Lighting

Complete Wire Harness

B3024-157	Original Design		\$1001.25
B3024-319	Modified for Delco 10SI Alternator (3 Wire)		\$1001.25

Includes Listed Components Below and Can Be Purchased Separately

Front Main Harness

B3024-215	Original Design	Replaces IHC/Farmall: #405279R1 Front Main	\$223.50
B3024-316	Modified for Delco 10SI Alternator (3 Wire)	Replaces IHC/Farmall: #405279R1 Front Main	\$223.50
B3024-131	Rear Main Harness	Replaces IHC/Farmall: #405292R2 Rear Main	\$357.50
B3024-183	Right Dash Harness	Replaces IHC/Farmall: #398924R1, 405275R1, 528175R1 Right Dash	\$143.25
B3024-134	Left Dash Harness	Replaces IHC/Farmall: #398923R1, 405274R1, 406121R1 Left Dash	\$102.50
B3024-291	Ether Assist Harness	Replaces IHC/Farmall: #395076R1 Ether Assist Harness	\$25.75
B3024-135	Deluxe Fender Harness	Replaces IHC/Farmall: #388949R1, #404393R1, #405287R1, #405949R1 Deluxe Fender Harness	\$209.50

Farmall 1466 Diesel (Up To Serial #10324) with Deluxe Fender Lighting

B3024-282	Complete Wire Harness Original Design with 10DN Alternator (External Voltage Regulator)		\$902.00
------------------	---	--	-----------------

Includes Listed Components Below and Can Be Purchased Separately

B3024-288	Main Harness	Replaces IHC/Farmall: #534368R1 Main	\$437.75
B3024-180	Dash Harness	Replaces IHC/Farmall: #534367R1 Dash	\$182.75
B3024-181	Deluxe Fender Harness	Replaces IHC/Farmall: #4052209R1, 405877R1, 533254R1, 533255R1, 533256R1 Deluxe Fender Harness	\$332.00

Farmall 1466 Diesel (Serial #10325 & Up) with Deluxe Fender Lighting

B3024-223	Complete Wire Harness Original Design with 10SI Alternator (3 Wire with Internal Regulator)		\$902.00
------------------	---	--	-----------------

Includes Listed Components Below and Can Be Purchased Separately

B3024-178	Front Main Harness	Replaces IHC/Farmall: #538995R1 Front Main	\$437.75
B3024-180	Dash Harness	Replaces IHC/Farmall: #534367R1 Dash	\$182.75
B3024-181	Deluxe Fender Harness	Replaces IHC/Farmall: #4052209R1, 405877R1, 533254R1, 533255R1, 533256R1 Deluxe Fender Harness	\$332.00

Farmall 1468 Diesel with Deluxe Fender Lighting

B3024-224	Complete Wire Harness Original Design with 10SI Alternator (3 Wire with Internal Regulator)		\$902.00
------------------	---	--	-----------------

Includes Listed Components Below and Can Be Purchased Separately

B3024-178	Front Main Harness	Replaces IHC/Farmall: #538995R1 Front Main	\$437.75
B3024-180	Dash Harness	Replaces IHC/Farmall: #534367R1 Dash	\$182.75
B3024-181	Deluxe Fender Harness	Replaces IHC/Farmall: #4052209R1, 405877R1, 533254R1, 533255R1, 533256R1 Deluxe Fender Harness	\$332.00

Farmall 1566 Diesel with Deluxe Fender Lighting

B3024-225	Complete Wire Harness Original Design with 10SI Alternator (3 Wire with Internal Regulator)		\$902.00
------------------	---	--	-----------------

Includes Listed Components Below and Can Be Purchased Separately

B3024-178	Front Main Harness	Replaces IHC/Farmall: #538995R1 Front Main	\$437.75
B3024-180	Dash Harness	Replaces IHC/Farmall: #534367R1 Dash	\$182.75
B3024-181	Deluxe Fender Harness	Replaces IHC/Farmall: #4052209R1, 405877R1, 533254R1, 533255R1, 533256R1 Deluxe Fender Harness	\$332.00

Farmall 1568 Diesel with Deluxe Fender Lighting

B3024-283	Complete Wire Harness Original Design with 10SI Alternator (3 Wire with Internal Regulator)		\$902.00
------------------	---	--	-----------------

Includes Listed Components Below and Can Be Purchased Separately

B3024-178	Front Main Harness	Replaces IHC/Farmall: #538995R1 Front Main	\$437.75
B3024-180	Dash Harness	Replaces IHC/Farmall: #534367R1 Dash	\$182.75
B3024-181	Deluxe Fender Harness	Replaces IHC/Farmall: #4052209R1, 405877R1, 533254R1, 533255R1, 533256R1 Deluxe Fender Harness	\$332.00

IHC/Farmall 2706 Gas with Deluxe Fender Lighting

Complete Wire Harness

B3024-154	Original Design with Generator		\$863.75
B3024-207	Original Design with 10DN Alternator (External Voltage Regulator)		\$863.75

Includes Listed Components Below and Can Be Purchased Separately

Front Main Harness

B3024-125	Original Design with Generator	Replaces IHC/Farmall: #384457R91, #385009R91, #393566R91 Front Main	\$182.75
B3024-209	Original Design with 10DN Alternator (External Voltage Regulator)	Replaces IHC/Farmall: #384552R1 Front Main	\$182.75

Rear Main Harness

B3024-126	Original Design with Generator	Replaces IHC/Farmall: #384456R91, #385010R91 Rear Main	\$317.75
B3024-210	Original Design with 10DN Alternator (Has External Voltage Regulator)	Replaces IHC/Farmall: #384999R91, #385010R91 Rear Main	\$317.75
B3024-127	Right Dash Harness	Replaces IHC/Farmall: #405251R2 Right Dash	\$135.25
B3024-128	Left Dash Harness	Replaces IHC/Farmall: #405250R1 Left Dash	\$82.75
B3024-129	Deluxe Fender Harness	Replaces IHC/Farmall: #388948R1, 388949R1 (2 Used), 394130R91, 394265R91 Deluxe Fender Harness	\$196.75

Farmall 2756 Gas with Deluxe Fender Lighting

Complete Wire Harness

B3024-130	Original Design		\$1003.50
B3024-333	Modified for Delco 10SI Alternator (3 Wire)		\$1003.50

Includes Listed Components Below and Can Be Purchased Separately

Front Main Harness

B3024-148	Original Design with 10DN Alternator	Replaces IHC/Farmall: #398916R1 Front Main	\$249.25
B3024-332	Modified for Delco 10SI Alternator (3 Wire)	Replaces IHC/Farmall: #398916R1 Front Main	\$249.25
B3024-132	Rear Main Harness	Replaces IHC/Farmall: #398915R1 Rear Main	\$357.50
B3024-133	Right Dash Harness	Replaces IHC/Farmall: #398923R1 Right Dash	\$143.25
B3024-134	Left Dash Harness	Replaces IHC/Farmall: #398923R1, 405274R1, 406121R1 Left Dash	\$102.50
B3024-135	Deluxe Fender Harness	Replaces IHC/Farmall: #388949R1, #404393R1, #405287R1, #405949R1 Deluxe Fender Harness	\$209.50

Farmall 2806 Gas with Deluxe Fender Lighting

Complete Wire Harness

B3024-155	Original Design with Generator		\$863.75
B3024-208	Original Design with 10DN Alternator (External Voltage Regulator)		\$863.75

Includes Listed Components Below and Can Be Purchased Separately

Front Main Harness

B3024-125	Original Design with Generator	Replaces IHC/Farmall: #384457R91, #385009R91, #393566R91 Front Main	\$182.75
B3024-209	Original Design with 10DN Alternator (External Voltage Regulator)	Replaces IHC/Farmall: #384552R1 Front Main	\$182.75

Rear Main Harness

B3024-126	Original Design with Generator	Replaces IHC/Farmall: #384456R91, #385010R91 Rear Main	\$317.75
B3024-210	Original Design with 10DN Alternator (Has External Voltage Regulator)	Replaces IHC/Farmall: #384999R91, #385010R91 Rear Main	\$317.75
B3024-127	Right Dash Harness	Replaces IHC/Farmall: #405251R2 Right Dash	\$135.25
B3024-128	Left Dash Harness	Replaces IHC/Farmall: #405250R1 Left Dash	\$82.75
B3024-129	Deluxe Fender Harness	Replaces IHC/Farmall: #388948R1, 388949R1 (2 Used), 394130R91, 394265R91 Deluxe Fender Harness	\$196.75

Farmall 2856 Diesel with Deluxe Fender Lighting

Complete Wire Harness

B3024-186	Original Design with 10DN Alternator		\$1001.25
B3024-311	Modified for Delco 10SI Alternator (3 Wire)		\$1001.25

Includes Listed Components Below and Can Be Purchased Separately

Front Main Harness

B3024-137	Original Design with 10DN Alternator	Replaces IHC/Farmall: #398929R1, #405278R1 Front Main	\$223.50
B3024-307	Modified for Delco 10SI Alternator (3 Wire)	Replaces IHC/Farmall: #398929R1, #405278R1 Front Main	\$223.50
B3024-131	Rear Main Harness	Replaces IHC/Farmall: #405292R2 Rear Main	\$357.50
B3024-183	Right Dash Harness	Replaces IHC/Farmall: #398924R1, 405275R1, 528175R1 Right Dash	\$143.25
B3024-134	Left Dash Harness	Replaces IHC/Farmall: #398923R1, 405274R1, 406121R1 Left Dash	\$102.50
B3024-291	Ether Assist Harness	Replaces IHC/Farmall: #395076R1 Ether Assist Harness	\$25.75
B3024-135	Deluxe Fender Harness	Replaces IHC/Farmall: #388949R1, #404393R1, #405287R1, #405949R1 Deluxe Fender Harness	\$209.50

Note

When ordering, please specify **Year** or **Serial Number**, Magneto/Distributor, & Regulator/Cut Out Relay.
Some Harnesses were originally made with PVC Wire & Braided; others were made with PVC Wire & Taped.
In those cases, we build them the **Original Way**.

Wiring Harness Clips

B9027-001	Wiring Harness Clip Set	\$49.99
	IHC/Farmall Fits: M, MV (Gas & LP), Super A, Super MV (Gas & LP Up to Serial # F28174)	
B9027-002	Wiring Harness Clip Set	\$49.99
	IHC/Farmall Fits: H, HV, Super H, Super HV (Up to Serial #19,233)	

REPLACEMENT DISTRIBUTORS

357935R91	IHC/Farmall Complete Distributor	\$129.00
	4 Cyl. Complete New Replacement Distributor Replaces: #107296C91, 107299C91, 107302C91, 107304C91, 353890R91, 353898R11, 354900R91, 357935R91, 362473R91, 362722R91, 364653R91, 364696R92, 366928R91, 372712R91, 380622R91 Distributor Housing Casting Number: #353898R11, 354900R91, 357935R91, 362473R91, 362722R91, 364653R91, 364696R92, 366928R91, 372712R91, 380622R91 Fits: (Gas/LP) - Cub, Lo-Boy, A, Super A, AV, Super AV, B, BN, C, Super C, H, Super H, HV, Super HV, M, Super M, MTA, Super MTA, MV, Super MV, Super O, O4, O6, OS4, OS6, T5, T6, T340, W4, Super W4, W6, Super W6, W6TA, W400, W450, 100, 130, 140, 154, 184, 185, 200, 230, 240, 300, 330, 340, 350, 400, 404, 424, 444, 450, 504 <u>Industrials: I4, I6, T4, T6, 500, 2404, 2424, 2444, 2504, 3444, 3514</u>	

B4008-018	Distributor Hold-Down Clamp	\$7.99
	<p>Note: 2 Used; Each Sold Separately IHC/Farmall: Replaces: #341139R1, 353937R1 Fits (when equipped with IH horizontal distributor): A, AV, B, BN, C, Cub, Cub Loboy, H, Hydro 70, Hydro 86, I4, I6, I9, ID6, ID9HV, M, MD, MDV, T5, MV, O4, O6, ODS6, OS4, OS6, Super WDR9, 414, Super A, Super A-1, Super AV, Super AV-1, Super C, Super H, Super HV, Super M, Super MD, Super MDV, Super MDV-TA, Super MTA diesel, Super MV, Super MVTA, Super W4, Super W6, Super W6TA, Super WD6, Super WD6TA, Super W9, Super WD9, T340, TD14A, TD14, TD6-61, T6-62, W4, W6, W9, WD9, WDR9, WR9S, 55T, 56T, 56W, 574, 57T, 100, 130, 140, 154, 161, 184, 185, 200, 201, 240, 300, 330, 340, 350, 400, 420, 422, 404, 416, 424, 444, 450, 454, 460, 464, 504, 544, 560, 600, 606, 616, 622, 650, 656, 660, 666, 674, 686, 706, 756, 766, 806, 826, 856, 2510B, 2544, 2606, 2656, 2706, 2806, 2826 Industrials: 100C, 230, 500, 2404, 2424, 2444, 2504, 2856, 3514, 3616, 3800, 3850, 4000, 2400A, 2400B, 2405B, 2410B, 2412B, 2500A, 2500B, 2505B, 2514B, 3400A, 3500A, 3600A, 4500A 4500B, 500C, H30B, H30F, H30R, H50A, H50B, H50C, H60B, T4, T6, T6-61, T9, TD9, TD9-91</p>	

	B4007-004	\$7.99
	Distributor Cap Clip Bracket & Screw	Replaces: #107386C1, 121832, 353895R1
	B4008-016	\$24.75
	IH Breaker Plate	Replaces: #352277R11
	B4008-020	\$7.50
	IH Distributor Advance Spring	Replaces: #353918R1
	B4008-010	\$28.99
	IH Distributor Drive Gear	Replaces: #353902R1, 531461R91
	B4008-011	\$29.99
	IH Distributor Drive Shaft	Replaces: #353934R11
	B4008-017	\$98.99
	Used Distributor Drive Housing w/ Tachometer Hole	Replaces: #363749R91, 363763R11
	B4009-003	\$39.99
	Distributor Shaft Bushing & Shim Kit	Replaces: #252739R1, 352298R1, 353899R1, 353921R1, 373577R91, 86637641
	B4005-003	\$59.99
	Original Style IHC 6 Volt Coil	Replaces: #353874R91, 396546R91 Note: Must be used with B4008-005 Coil Bracket
	B4005-004	\$57.99
	Original Style IHC 12 Volt Coil (Must be used with Ballast Resistor)	Replaces: #353875R91, 395331R91 Note: Must be used with B4008-005 Coil Bracket
	B4008-005	\$16.99
	IHC Distributor Coil Bracket	Replaces: # 353889R1 Used with #B4005-003 & #B4005-004 6- & 12-Volt IHC Distributor Coils
	B4008-023	\$18.99
	Primary Screw & Insulator Kit	Includes: Terminal Screw (B4008-003), Insulating Terminal Washer (B4008-004), IH Distributor Insulator (B4008-013) Replaces: #120622, 121841, 251538R1, 353906R1, 353907R1 Fits: IH Distributor (#368051R1, 401107R1, 353898R11)

*For 6-Volt Ignition Coils & Accessories, see p.44

TUNE UP PARTS FOR BATTERY IGNITION

IHC/Farmall with IHC Distributors

A, AV, Super A, Super AV, B, BN, C, Super C, Cub, Cub Loboy, H, HV, Super H, Super HV, I4, I6, I9, ID6, ID9, M, MD, MDV, MV, Super M, Super MD, Super MDV, Super MTA, Super MV, O4, O6, ODS6, T6, TD6, TD9, W4, Super W4, W6, Super W6, W61, W67A, W6TD, W400, W450, 100, 130, 140, 200, 230, 240, 300, 330, 340, 350, 400, 404, 424, 444, 450, 464, 600, 650, 2404, 2424, 2444

	B4100-007	\$12.75
	PCR Kit	Includes: Points (#B4001-015), Condenser (#B4002-011), Rotor (#B4004-011) Replaces: Points - #353172R91 Condenser - #353903R91 Rotor - #353896R91
	B4003-011	\$13.50
	Cap	Replaces: #351693R91, 351693R92 Premium Quality, USA Made with Brass Contacts
	B4004-011	\$4.75
	Rotor	Replaces: #353896R91
	B4007-003	\$14.99
	Cap Clip	2 Used Replaces: #353894R1
	B4006-003	\$13.99
	Dust Cover	Replaces: #353900R11

IHC/Farmall with Vertical Delco Distributors Cub, Lo-Boy, A, B, C, H, M, O4, OS6, W4, W6, W61, W67A, W6TD, W67A, W400, W450, 100, 130, 140, 200, 230, 240, 300, 330, 340, 350, 400, 404, 424, 444, 450, 464, & Supers		
	B4100-001	\$10.50
PCR Kit Includes: Points (#B4001-001), Condenser (#B4002-001), Rotor (#B4004-002) Replaces: Points - #D100HP, 1855720 Condenser - #1928111, D-203, 1869704, D-200 Rotor - #820445, D400		
	B4004-002	\$5.75
Rotor Replaces: #820445, D400		
	B4003-001	\$13.50
Distributor Cap Premium Grade, Made in the USA (Brass Contacts) Replaces: #811735, D300		
	B4006-001	\$9.99
Dust Cover Replaces: #1900119		
	B4007-001	\$11.95
Cap Clip Short Mount, 1 Used Replaces: #1889967, 1847289, 453844, 453461		
	B4007-002	\$11.95
Cap Clip Long Mount, 1 Used Replaces: #1889967, 1889999, 453844, 453461		
	B4008-001	\$14.99
Distributor Insulator Replaces: #1904376		
	B4009-001	\$25.99
Distributor Bushing & Shim Kit		

*For 6- or 12-Volt Ignition Coils & Accessories, see p.44

IHC/Farmall with Prestolite IBT-4102 (IHC #107298C91) & Prestolite #IBT-4106 (IHC #107290C91) Distributors Cub, Cub Lo-Boy, A, Super A, B, C, Super C, H, Super H, M, Super M, MD, Super MD, O4, OS6, T6, W4, Super W4, W6, Super W6, W61, W67A, W6TD, W67A, W9, Super W9, W400, W450, 100, 130, 140, 200, 230, 240, 300, 330, 340, 350, 400, 404, 424, 444, 450, 464, 574, 2424, 2444		
	B4001-017	\$6.50
Points Replaces: #IBP-2040L, IBP-3028BS, 1-33, 1-47V, 1-48		

	B4002-006	\$7.50
Condenser Replaces: #2-31, 2-38, 2-42, 2-95, IAT-1125S, IAT-3076BS, IBB-2042SS-1, IBB-2042-SS3, IG-3927F, IG-3927G, IG-3927K, IG-3927R,		
	B4004-012	\$7.25
Rotor Premium Grade, Made in the USA Replaces: #4-86, 4-93		
	B4003-012	\$15.00
Distributor Cap Made in the USA (Brass Contacts) Replaces: #3-129, IBK-1009		

*For 6- or 12-Volt Ignition Coils & Accessories, see p.44

IHC/Farmall with WICO Distributors #XB4011, XB4013, XB4018 Cub, Lo-Boy, A, AV, Super A, B, C, Super C, H, HV, Super H, Super HV, M, MV, Super M, Super MV, O4, OS6, W4, W6, W61, W67A, W6TD, W67A, W400, W450, 100, 130, 140, 200, 230, 240, 300, 330, 340, 350, 400, 404, 424, 444, 450, 464		
	B4011-004	\$17.75
Points Replaces: #1-5008, 1-5111, FXH-2100B, FXH-2400B, X5996		
	B4002-004	\$11.00
Condenser Replaces: #90-5072		
	B4013-004	\$36.75
Cap Includes #B4016-004 Replaces: #3-5014		
	B4014-002	\$23.50
Rotor Replaces: #4-5010		
	B4016-004	\$2.25
Cap Gasket Replaces: #94-5076		
	B4017-004	\$8.50
Coil Bar Replaces: #94-5066		

	B4017-007 Impulse Spring Replaces: #94-5016	\$12.50
	B4017-047 Resistor Coil Wire For 12-Volt WICO XB Distributors Only	\$24.75
	B4017-008 Stop Button Assembly Includes #B4017-009 Replaces: #90-5042 For the version with a Ground Wire, use #B4017-063 (\$7.26) instead.	\$6.25
	B4017-009 Stop Button Replaces: #94-5079	\$2.25
	B4016-005 Flange Gasket Replaces: #SAE	\$1.75

	B4007-002 Cap Clip Long Mount, 1 Used Replaces: #1889967, 1889999, 453844, 453461	\$11.95
	B4008-001 Distributor Insulator Replaces: #1904376	\$14.99
	B4009-001 Distributor Bushing & Shim Kit	\$25.99

*For 6-Volt Ignition Coils & Accessories, see p.44

IHC/Farmall with IHC Distributors 504, 2504, D-248, D-264		
	B4100-008 PCR Kit Includes: Points (#B4001-016), Condenser (#B4002-011), Rotor (#B4004-011) Replaces: Points - #372951R91 Condenser - #353903R91 Rotor - #353896R91	\$12.75
	B4003-011 Cap, 4 Cylinder IH Distributor Replaces: #351693R91, 351693R92 Premium Quality, USA Made with Brass Contacts	\$13.50
	B4004-011 Rotor Replaces: #353896R91	\$4.75
	B4007-003 Cap Clip 2 Used Replaces: #353894R1	\$14.99
	B4006-003 Dust Cover Replaces: #353900R11	\$13.99
	B4008-020 IH Distributor Advance Spring Replaces: #353918R1	\$7.50
	B4008-016 IH Breaker Plate Replaces: #352277R11	\$24.75
	B4005-004 Original Style IHC 12 Volt Coil Replaces: #353875R91, 395331R91	\$57.99

IHC/Farmall with Delco Distributors 354, B414, 434		
	B4001-013 Points Replaces: #1938330 (D-103P), 1882024 (D103), 1871678, 1871870, 1918148	\$16.25
	B4002-001 Condenser Replaces: #1928111, D-203, 1869704, D-200	\$4.75
	B4004-002 Rotor Replaces: #820445, D400	\$5.75
	B4003-001 Distributor Cap Premium Grade, Made in the USA (Brass Contacts) Replaces: #811735, D300	\$13.50
	B4006-001 Dust Cover Replaces: #1900119	\$9.99
	B4007-001 Cap Clip Short Mount, 1 Used Replaces: #1889967, 1847289, 453844, 453461	\$11.95

	B4008-023	\$18.99
	Primary Screw & Insulator Kit Includes: Terminal Screw (B4008-003), Insulating Terminal Washer (B4008-004), IH Distributor Insulator (B4008-013) Replaces: #120622, 121841, 251538R1, 353906R1, 353907R1 Fits: IH Distributor (#368051R1, 401107R1, 353898R11)	

*For 6- or 12-Volt Ignition Coils & Accessories, see p.44

IHC/Farmall with IHC Horizontal Distributors
 460, 560, 756, 766, 806, 826, 856, 2606, 2656, 2806,
 2826, 2856

	B4100-007	\$12.75
	PCR Kit Includes: Points (#B4001-015), Condenser (#B4002-011), Rotor (#B4004-011) Replaces: Points - #353172R91 Condenser - #353903R91 Rotor - #353896R91	

	B4003-013	\$19.25
	Cap, 6 Cylinder IH Distributor Replaces: #356189R91, 368062R91	

	B4004-011	\$4.75
	Rotor Replaces: #353896R91	

	B4007-003	\$14.99
	Cap Clip 2 Used Replaces: #353894R1	

	B4006-003	\$13.50
	Dust Cover Replaces: #353900R11	

	B4008-020	\$7.50
	IH Distributor Advance Spring Replaces: #353918R1	

	B4005-003	\$59.99
	Original Style IHC 6 Volt Coil Replaces: #353874R91, 396546R91	

	B4008-023	\$18.99
	Primary Screw & Insulator Kit Includes: Terminal Screw (B4008-003), Insulating Terminal Washer (B4008-004), IH Distributor Insulator (B4008-013) Replaces: #120622, 121841, 251538R1, 353906R1, 353907R1 Fits: IH Distributor (#368051R1, 401107R1, 353898R11)	

*For 12-Volt Ignition Coils & Accessories, see p.44

IHC/Farmall with Prestolite IBT-6201A Distributor
 460, 560, 706, 756, 766, 806, 826, 856, 2606, 2656,
 2806, 2826, 2856

	B4001-017	\$6.50
	Points Replaces: #IBP-2040L, IBP-3028BS, 1- 33, 1-47V, 1-48	

	B4002-006	\$7.50
	Condenser Replaces: #2-31, 2-38, 2-42, 2-95, IAT- 1125S, IAT-3076BS, IBB-2042SS-1, IBB-2042-SS3, IG-3927F, IG-3927G, IG- 3927K, IG-3927R,	

	B4003-014	\$20.50
	Cap Replaces: #IBK-1007A, 3-56, 3-138	

	B4004-012	\$7.25
	Rotor Premium Grade, Made in the USA Replaces: #4-86, 4-93	

*For 12-Volt Ignition Coils & Accessories, see p.44

IHC/Farmall with IHC Distributors
 606, 656, 660, 666, 706, 756, 766, 806, 826, 856, 2706,
 2756, 2826, 2806, 2856, 3400 3450, 3800, 3850

	B4100-008	\$12.75
	PCR Kit Includes: Points (#B4001-016), Condenser (#B4002-011), Rotor (#B4004-011) Replaces: Points - #372951R91 Condenser - #353903R91 Rotor - #353896R91	

	B4003-013	\$19.25
	Cap Replaces: #356189R91	

	B4004-011	\$4.75
	Rotor Replaces: #353896R91	

	B4007-003	\$14.99
	Cap Clip 2 Used Replaces: #353894R1	

	B4006-003	\$13.99
	Dust Cover Replaces: #353900R11	

	B4008-020	\$7.50
	IH Distributor Advance Spring Replaces: #353918R1	

	B4005-004	\$57.99
	Original Style IHC 12 Volt Coil Replaces: #353875R91, 395331R91	
	B4008-023	\$18.99
	Primary Screw & Insulator Kit Includes: Terminal Screw (B4008-003), Insulating Terminal Washer (B4008-004), IH Distributor Insulator (B4008-013) Replaces: #120622, 121841, 251538R1, 353906R1, 353907R1 Fits: IH Distributor (#368051R1, 401107R1, 353898R11)	

*For 12-Volt Ignition Coils & Accessories, see p.44

IHC/Farmall with Delco Distributor #1112489, 1112697 544, 574, 2544, 3514		
	B4100-003	\$9.75
	PCR Kit Includes: Points (#B4001-012), Condenser (#B4002-012), Rotor (#B4004-013) Replaces: Points - #D108P Condenser - #D205 Rotor - #D-419R, 1963972	
	B4004-013	\$4.75
	Rotor Premium Grade, Made in the USA Replaces: #D-419R, 1963972	
	B4003-015	\$16.25
	Distributor Cap Brass Contacts Replaces: #D-322	
B4006-004	Dust Cover Replaces: #1960325	\$16.99

*For 12-Volt Ignition Coils & Accessories, see p.44

BATTERY BOX GROMMET

B9033-001	IHC Battery Box Grommet	\$1.50
	Grommet for Battery box on IHC/Farmall Replaces: #248-1146, 52118D, 24179D Fits: Cub, A, B, C, H, M, I, W, O, & SUPERS, 100, 130, 140, 200, 230, 240, 300, 330, 340, 350, 400, 450 (Most tractors use 2 pieces)	

CONTROL BOX GROMMET

B9033-002	IHC Control Box Grommet	\$2.00
	Grommet for control box on IHC/Farmall Replaces: #52062D Fits: A, AV, B, BN, C, H, HV, I4, I6, I9, ID6, ID9, M, MD, MDV, MV, O4, O6, ODS6, OS6, Super H, Super M, Super MD, Super MTA, Super W4, Super W6, Super W9, Super WDR9, W4, W6, W9, WD9, WDR9, WR9	

BATTERY BOX LOCK BOLTS

51712D	Battery Box Support Lock Bolt	\$5.95
	Steel Lock Bolt for IHC/Farmall Battery Boxes (2 Used Per Tractor) IHC/Farmall Replaces: #51712D Fits: M, MD, MDV, MV, Super M & Super MV (Up to Serial #F28174 & #L504801), Super MD & Super MDV (Up to Serial #F28174)	

JUNCTION BLOCKS

B9031-004	1 Terminal Junction Block	\$8.99
	IHC/Farmall Replaces: #304314R91, 300559R91, 1998754, 42915D Fits (All used as a light wire, hour meter wire, or safety switch/ wire junction block) - A-I (SN: 286222-& up with magneto), C (SN: 47126-& up with voltage regulator & magneto), Cub & Cub Loboy (with voltage regulator & magneto with offset steering), H & HV (SN: 340954 & up with voltage regulator & magneto), I4 (SN: 36786 & up), I6 (SN: 36786-up), ID6 (up to SN: 31237), I9, ID9, M & MV (SN: 22911-up), MD, MDV, O4, O6, ODS6, OS4, OS6, Super M, Super MD, Super MDV, Super MDV-TA, Super MTA (Diesel), Super MV, Super MVTa, Super W4, Super W6, Super W6TA, Super W9, Super WD6, Super WD6TA, Super WD9, Super WDR9, T340, T6-62, TD14, TD14A, TD15B, TD18, TD18A, TD20B (up to SN: 22994), TD20C, TD24, TD340, TD340, TD6-62, W4, W6, W6TA, W9, WD6, WD9, WDR9, WR9S, 150, 330, 340 (Diesel), 350 (with magneto), 400 (Wheatland), 404, 424, 450 (Wheatland), 460 (up to SN: 15843), 560 (up to SN: 25617), 600, 606, 650, 660 (Standard), 2424, 2504, 4100 (With voltage regulator & magneto) - Super A, Super AV, Super AV-1, & Super C (With magneto) - Super H, T6, T9, TD6, TD9, 100, 130, 140, 200, & 230 (Used as a glow plug junction block; diesel) - TD340, TD6-62, TD9B, 340, 3600A, 460, 504, 560, 606, 656, 660, 706, 2504, 2656, 3514, 3616, 3800, 3850 Utility: 240, 300, 340, 350, 460, 504	

B9031-005	3 Terminal Junction Block	\$28.99
	IHC/Farmall Replaces: #371031R91, 378336R91 Fits: (Used as a dash / cab junction block- usually mounts under the dash panel)- Hydro 70, Hydro 86, Hydro 100, 404, 424, 444, 454, 464, 504, 544, 574, 606, 656, 664, 666, 674, 686, 706, 756, 766, 806, 826, 856, 966, 1026, 1066, 1206, 1256, 1456, 1466, 1468, 1566, 1568, 4100, 4156, 4166, 4186, 4366 (Serviceable for / has studs instead of screw terminals as a tail light junction block; mounts to rear of battery box) - Cub (SN: 210001 to 224400), Cub Loboy (SN: 10001 to 18700) Utility: 500, 2404, 2424, 2444, 2504, 2544, 2606, 2656, 2656, 2706, 2756, 2756, 2806, 2826, 2826, 2856, 21026, 21206, 2400A, 2400B, 2500A, 2500B	

ELECTRONIC IGNITION CONVERSION KITS

Replaces Points & Condenser



IHC/Farmall with Horizontal IHC Distributor 4 Cyl. Cub, Cub Lo-Boy, A, B, C, H, M, I4, O4, O6, OS6, W4, W6, W61, W67A, W400, W450, 100, 130, 140, 200, 230, 240, 300, 330, 340, 350, 400, 404, 424, 444, 450, 464, 2404, 2424, 2444, & Supers		
B9600-046	12 Volt Negative Ground	\$149.95
B9600-046II	12 Volt Negative Ground with Upgraded Current Protection	\$205.95
B9600-046P12	12 Volt Positive Ground	\$165.45
B9600-046P6	6 Volt Positive Ground	\$165.45

IHC/Farmall with Vertical Delco Distributor 4 Cyl. Cub, Cub Lo-Boy, A, B, C, H, M, I4, O4, O6, OS6, W4, W6, W61, W67A, W400, W450, 100, 130, 140, 200, 230, 240, 300, 330, 340, 350, 400, 404, 424, 444, 450, 464, & Supers		
B9600-006	12 Volt Negative Ground	\$147.45
B9600-006P12	12 Volt Positive Ground	\$165.45
B9600-006P6	6 Volt Positive Ground	\$165.45

IHC/Farmall with Horizontal Replacement Distributor Prestolite IBT-4102 (IHC #107298C91) & Prestolite #IBT-4106 (IHC #107290C91) 4 Cyl. Cub, Cub Lo-Boy, A, B, C, H, M, I4, O4, O6, OS6, W4, W6, W61, W67A, W400, W450, 100, 130, 140, 200, 230, 240, 300, 330, 340, 350, 400, 404, 424, 444, 450, 464, 544, 574, 674, 2404, 2424, 2444, 2544, 3514, & Supers		
B9600-058	12 Volt Negative Ground	\$134.45
B9600-058P12	12 Volt Positive Ground	\$147.45
B9600-058P6	6 Volt Positive Ground	\$147.45

IHC/Farmall with Delco Distributor #1112489, 1112697 4 Cyl. 544, 574, 674, 2544, 3514		
B9600-009A	12 Volt Negative Ground	\$124.95
B9600-009AP12	12 Volt Positive Ground	\$139.95

IHC/Farmall with Delco Distributor, 4 Cyl. 354, 434 with Delco Distributor # D204-7953342, & 3414		
B9600-012A	12 Volt Negative Ground	\$149.45
B9600-012AP12	12 Volt Positive Ground	\$165.45

IHC/Farmall with Lucas Distributor #D3A4-40748B 4 Cyl. B414, 3414		
B9600-144	12 Volt Negative Ground	\$177.45
B9600-144P12	12 Volt Positive Ground	\$191.45

IHC/Farmall with Mazda Distributor 4 Cyl. 434		
B9600-163	12 Volt Negative Ground	\$129.95

IHC/Farmall with IHC Distributors 6 Cyl. Gas 460, 560, 606, 656, 660, 666, 686, 706, 756, 766, 806, 826, 856, Hydro 70, Hydro 86		
B9600-047	12 Volt Negative Ground	\$147.45

IHC/Farmall with IHC Replacement Distributor Prestolite #IBT-6201A 6 Cyl. Gas 460, 560, 606, 656, 660, 666, 686, 706, 756, 766, 806, 826, 856, Hydro 70, Hydro 86		
B9600-065	12 Volt Negative Ground	\$134.45
B9600-065P12	12 Volt Positive Ground	\$147.45



***For Ignition Coils & Accessories, see p.44**





TUNE UP PARTS FOR MAGNETO IGNITION

IHC/Farmall with Fairbanks-Morse Magneto #FMJ-4B11		
	B4110-004	\$33.95
	PCR Kit Includes: Points (#B4011-002), Condenser (#B4012-001), Rotor (#B4014-001) Replaces: Points - #R2437 Condenser - #AXMR2433 Rotor - #M2765	
	B4013-001	\$49.75
	Cap Replaces: #C800	
	B4013-002	\$49.75
	Cap (Inner) Replaces: #A2430C	
	B4015-002	\$39.75
	Coil Replaces: #R2477C	
	B4016-001	\$2.75
	Cap Gasket (Outer) Replaces: #B682	
	B4016-002	\$2.75
	Cap Gasket (Inner) Replaces: #H2498	
	B4016-003	\$14.75
	Complete Gasket Set Includes # H2498 (B4016-002), B682 (B4016-001), G2501, G3861, A2492A, Replaces: #GK17	



	B4016-005 Flange Gasket Replaces: #SAE	\$1.75
	B4017-049 Service Repair Kit Replaces: #SK3, AXMR2433, R2437, E2460B, M2765, A5931B, 10S14D, A2492A, B682, G2501, G3861, H2498	\$93.75
	B4017-001 Coil Lead Replaces: #FMJL	\$2.75
	B4017-062 High Tension Rod Replaces: J983A	\$12.75
	B4017-036 Distributor Shaft and Gear Replaces: #N5939	\$14.75
	B4017-037 Rotor Pinion Gear Replaces: #F5952	\$21.25
	B4017-002 Rear Ball Bearing Replaces: #C5949	\$11.75
	B4017-041 Coupling Impulse Spring Replaces: #D2565	\$16.00
B4017-058	FMJ Distributor Shaft Clip	\$2.25
B4017-059	FMJ Distributor Shaft Washer	\$2.25
B4017-060	FMJ Distributor Shaft Felt Seal	\$1.75

IHC/Farmall with **Fairbanks-Morse Magneto**
#FMX-4B11

	B4110-005 PCR Kit Includes: Points (#B4011-003), Condenser (#B4012-001), Rotor (#B4014-001) Replaces: Points - #A2437A Condenser - #AXMR2433 Rotor - #M2765	\$39.50
	B4013-001 Cap Replaces: #C800	\$49.75
	B4013-003 Cap (Inner) Replaces: #AZ2430C	\$38.75

	B4015-002 Coil Replaces: #R2477C	\$39.75
	B4016-001 Cap Gasket (Outer) Replaces: #B682	\$2.75
	B4016-002 Cap Gasket (Inner) Replaces: #H2498	\$2.75
	B4016-003 Complete Gasket Set Includes # H2498 (B4016-002), B682 (B4016-001), G2501, G3861, A2492A, Replaces: #GK17	\$14.75
	B4016-005 Flange Gasket Replaces: #SAE	\$1.75
	B4017-001 Coil Lead Replaces: #FMJL	\$2.75
	B4014-009 Rotor Gear Replaces: #Y5939	\$29.75
	B4017-002 Rear Ball Bearing Replaces: #C5949	\$11.75
	B4017-041 Coupling Impulse Spring Replaces: #D2565	\$16.00
	B4017-050 High Tension Rod Replaces: A983A	\$12.75

IHC/Farmall
Regular (Some), F12, F14, F20, F30, I12, O12, T20, W12, W14, W40 with **F4 Magneto**

	B4011-008 Points Replaces: #353173R91	\$14.75
	B4012-005 Condenser Replaces: #373892R92, 21409DB, 47546D	\$9.25

Wiring Harnesses, Battery Cables, & Spark Plug Wires, Proudly Made in the USA!

	B4015-005	\$44.75
	Coil Replaces: #21401D, 21401DAX, 57926DX, 47439D Premium Quality, Made in the USA	
	B4013-006	\$34.75
	Cap Replaces: #21344DAY	
	B4016-010	\$5.25
	Cover Gasket Replaces: #21319D	
	B4017-013	\$5.25
	F4 Brush Set Replaces: #E4A-594-X	
	B4017-012	\$21.00
	Point Cover Replaces: #2549DX	
	B4017-043	\$22.75
	Secondary Lead Out Tower Replaces: #21364DBY	
	B4017-061	\$35.00
	F4 Magneto Drive Coupling - 3/8" thick	
	B4017-054	\$35.00
	Early F4 to Late F4 Magneto Drive Coupling Converter - 7/8" thick with 5/16" drive slots on both sides	
	B4017-056	\$35.00
	E4 to Late F4 Magneto Drive Coupling Converter - 7/8" thick with 5/16" drive slot on one side, 1/4" drive slot on the other side	

	B4013-021	\$13.75
	Magneto Cap Replaces: #47413DYC Premium Quality, Made in the USA with Brass Contacts	
	B4014-003	\$9.00
	Rotor Replaces: #47425DY	
	B4017-010	\$19.75
	Rotor Mount Driven Gear Replaces: #49420DX	
	B4015-005	\$44.75
	Coil Replaces: #21401D, 21401DAX, 57926DX, 47439D Premium Quality, Made in the USA	
	B4013-022	\$29.99
	Coil Cover Replaces: #47449DAY	
	B4016-017	\$7.50
	Gasket Set Replaces: #359966R1, 47408D, 47453D, 48472DA, 49419D, 55780DD, 55780DE, E4226	
	B4016-018	\$3.75
	Leather Seal Can be used with B4016-017 above	
	B4017-011	\$4.75
	Impulse Catch Return Spring 2 Used Replaces: #51303D	
	B4017-065	\$68.75
	H4 Impulse Assembly Removal Tool Replaces: #SE912	

IHC/Farmall: A, B, C, H, M, I4, O4, W4, I6, O6, T6, W6, & Supers with H4 Magneto		
	B4110-001	\$18.50
	PCR Kit Includes: Points (#B4011-009), Condenser (#B4012-005), Rotor (#B4014-003) Replaces: Points - #353171R91 Condenser - #373892R92, 21409DB, 47546D Rotor - #47425DY	

IHC/Farmall: Cub, Cub Lo-Boy with J4 Magneto		
	B4001-015	\$4.75
	Points Replaces: #353172R91	
	B4002-011	\$6.75
	Condenser Replaces: #353903R91	
	B4003-011	\$13.50
	Cap Replaces: #351693R91, 351693R92 Premium Quality, USA Made with Brass Contacts	
	B4014-011	\$41.99
	Cap Rotor Replaces: #351692R91	

	B4015-006	\$44.75
	J4 Magneto Coil Replaces: #352355R91	
	B4013-023	\$54.99
	J4 Coil Cover Replaces: #251502R11	
	B4016-007	\$9.50
	Gasket Set	
	B4014-010	\$9.79
	Pinion (Rotor) Gear Replaces: #251526R1	
	B4017-015	\$34.75
	Coil Bar Replaces: #251508R91	
	B4008-023	\$18.99
	Primary Screw & Insulator Kit Includes: Terminal Screw (B4008-003), Insulating Terminal Washer (B4008-004), IH Distributor Insulator (B4008-013) Replaces: #120622, 121841, 251538R1, 353906R1, 353907R1 Fits: J4 Magneto (Serial #139748 & Up)	
IHC/Farmall with WICO Magneto #XH184, XH1022, XH1344, XH1648, XH1769, XH2500, XH3000, XV2001, XV2001-B, XV2033, XV2033-B		
	B4011-004	\$17.75
	Points Replaces: #1-5008, 1-5111, FXH-2100B, FXH-2400B, X5996	
	B4012-002	\$13.75
	Condenser Replaces: #2-5007, X5614, X6916	
	B4017-040	\$2.75
	Condenser Clamp Replaces: #94-5167	
	B4013-004	\$36.75
	Cap Includes #B4016-004 Replaces: #3-5014	
	B4014-002	\$23.50
	Rotor Replaces: #4-5010	

	B4016-004	\$2.25
	Cap Gasket Replaces: #94-5076	
	B4016-012	\$2.25
	Striker Plate Gasket Replaces: #94-5154	
	B4015-003	\$39.75
	Coil (Hot Coil) Replaces: #5-5011, AR12006, FXH2403, X5700, X5700B, X5700C	
	B4017-003	\$2.25
	Coil Clamp 2 used, each sold separately Replaces: #94-5080	
	B4017-004	\$8.50
	Coil Bar Replaces: #94-5066	
	B4017-005	\$3.50
	Inner Bearing Replaces: #24-5000	
	B4017-006	\$9.75
	Outer Bearing Replaces: #25-5000	
	B4017-046	\$2.75
	Bearing Cage Snap Ring Replaces: #43-5055	
	B4017-007	\$12.50
	Impulse Spring Replaces: #94-5016	
	B4017-032	\$23.75
	Wico Counter-Clockwise Impulse Trip Arm Assembly Replaces: #94-5115	
	B4017-034	\$14.75
	CCW Paw Mount *Call for Availability* (Included with B4017-032 above) Replaces: #FXH-1025B, 90-5064	
	B4017-042	\$28.75
	XH Magneto Rear Bearing	
	B4017-066	\$5.50
	Wico C / X Impulse Paw	
	B4017-067	\$2.75
	Impulse Paw Retaining Clip	

	B4017-033 Wico Impulse Trip Dog Set Repair Kit Replaces: #90-5033	\$13.50
	B4017-008 Stop Button Assembly Includes #B4017-009 Replaces: #90-5042 For the version with a Ground Wire, use #B4017-063 (\$7.26) instead.	\$6.25
	B4017-009 Stop Button Replaces: #94-5079	\$2.25
	B4017-051 WICO Impulse Catch Plate Replaces: #94-5070, FXH-210S-1	\$10.25
	B4016-005 Flange Gasket Replaces: #SAE	\$1.75
	B4017-031 Drive Cup with Spring Assembly Replaces: #94-5359	\$44.00
	B9013-011 WICO Series X Nameplate Fits the WICO Series X magneto (Rivets included)	\$7.00
with WICO Magnetos #XHD2656, XHD2657, XHD2658, XHD2659		
	B4011-004 Points Replaces: #1-5008, 1-5111, FXH-2100B, FXH-2400B, X5996	\$17.75
	B4012-002 Condenser Replaces: #2-5007, X5614, X6916	\$13.75
	B4017-040 Condenser Clamp Replaces: #94-5167	\$2.75

	B4013-004 Cap Includes #B4016-004 Replaces: #3-5014	\$36.75
	B4014-002 Rotor Replaces: #4-5010	\$23.50
	B4016-004 Cap Gasket Replaces: #94-5076	\$2.25
	B4016-012 Striker Plate Gasket Replaces: #94-5154	\$2.25
	B4015-003 Coil (Hot Coil) Replaces: #5-5011, AR12006, FXH2403, X5700, X5700B, X5700C	\$39.75
	B4017-003 Coil Clamp 2 used, each sold separately Replaces: #94-5080	\$2.25
	B4017-004 Coil Bar Replaces: #94-5066	\$8.50
	B4017-005 Inner Bearing Replaces: #24-5000	\$3.50
	B4017-006 Outer Bearing Replaces: #25-5000	\$9.75
	B4017-046 Bearing Cage Snap Ring Replaces: #43-5055	\$2.75
	B4017-007 Impulse Spring Replaces: #94-5016	\$12.50

	B4017-051 WICO Impulse Catch Plate Replaces: #94-5070, FXH-210S-1	\$10.25
	B4017-009 Stop Button Replaces: #94-5079	\$2.25
	B4016-005 Flange Gasket Replaces: #SAE	\$1.75
B4017-042	XH Magneto Rear Bearing	\$28.75

IHC/Farmall Rebuilt H4 Magneto (Right Hand)			
	H4RR	Exchange	\$295.00
		Outright	\$430.00
For Gas Tractors IHC/Farmall: A, B, C, H, M, I4, O4, W4, I6, O6, T6, W6, & Supers Core Charge: \$135.00, See Notes			

IHC/Farmall Rebuilt H4 Magneto (Left Hand)			
	H4LR	Exchange	\$295.00
		Outright	\$470.00
Usually for Diesel Tractors IHC/Farmall: MD, ID64, OD6, TD6, WD6, I9*, ID9, TD9, W9*, WD9 & Supers (*Fits these gas versions too) Core Charge: \$175.00, See Notes			

IHC/Farmall Rebuilt J4 Magneto			
	J4MR	Exchange	\$345.00
		Outright	\$570.00
IHC/Farmall: Cub & Cub Lo-Boy Core Charge: \$225.00, See Notes			

REPLACEMENT MAGNETOS

Rebuilt Magnetos

Our Rebuilt Magnetos are completely torn down, cleaned, & inspected. They will (at the minimum) have the following new parts: Points, Condenser, Coil, Coil Insulators, Lead-out Tower, & Outside Covers, plus any additional parts that are needed to make the unit look & perform like new.

They come with a 1-Year Limited Warranty.

Notes:

1. Unless otherwise specified, cost is exchange price.
2. A core charge (see below) will be charged to your credit card until we receive your good core.
3. A good core is considered a complete magneto with no cracks or weld repairs. Only good cores will be credited.

*Magnetos must be used with copper ignition wire.
Use of any other type will Void the Warranty.*

Original

IHC/Farmall Rebuilt F4 Magneto			
	F4R	Exchange	\$295.00
		Outright	\$520.00
IHC/Farmall Gas Tractors: 10-20, 15-30, 22-36, F12, F14, F20, F30, O12, T20, & W12 Core Charge: \$225.00, See Notes			

Other

	XH184R	Exchange	\$445.00
		Outright	\$645.00
Rebuilt WICO Magneto 4 Cyl. Base Mount Core Charge: \$200.00, See Notes			

	XH1344R	Exchange	\$445.00
		Outright	\$645.00
Rebuilt WICO Magneto 4 Cyl. Flange Mount Core Charge: \$200.00, See Notes			

MAGNETO-TO-DISTRIBUTOR CONVERSION KITS

Farmall H4 Right Hand (Gas) Magneto to Distributor Conversion Kit (Points Ignition)

B9040-001	12-Volt	\$285.00
B9040-004	6-Volt	\$285.00



Converts H4 Right Hand (Gas) Magnetos to Distributor.
Kit includes:
- 4-Cylinder Complete Replacement Distributor
- Farmall Distributor Drive Shaft
- Distributor Drive Housing with Opening for Tachometer Drive,

x2 Hold Down Clamps, Drive Housing Block Off Plate, Mounting Gasket, Coil, & Coil Bracket

Fits **IHC/Farmall**: A, B, C, H, I4, I6, I9, O4, O6, M, Super A, Super C, Super H, Super M, Super O6, Super W6, Super W9

B9040-006	Farmall H4 Right Hand Magneto to Distributor Conversion Kit (Electronic Ignition)	\$415.00
------------------	--	-----------------

As #B9040-001 above, but converts H4 Right Hand Magnetos to Electronic Ignition Distributors (Negative Ground) instead.

CUTOUT RELAYS & VOLTAGE REGULATORS

Note: Due to modern battery design, voltage regulators can't be used to charge low or dead batteries. Doing so will destroy the voltage regulator and void the warranty.

B8001-001	6-Volt Cutout Relay	\$19.50
------------------	----------------------------	----------------



15 Amps, 6 Volt, Works Positive or Negative Ground

Replaces: **Autolite** – Replaces: #CB4014, C4012(9-5), C4012(9-4), C4012(9-1), R40061

Delco - #266P, 266N, 265P, 265N, 5015850, 812970, 265J, 820845, 812971, 1116816, 265G, 265H,

1116755, 1116751, 1116809DR, 265B, 1842859, 265C, 1867781, 265F, 265D Fits: **IHC** – Various Models

B8001-002	Electronic Cutout Relay	\$19.50
------------------	--------------------------------	----------------



25 Amp, Works with 6, 12, or 24 Volts. & Positive or Negative Ground

Replaces:

Autolite - #CB4014, C4012(9-5), C4012(9-4), C4012(9-1), R40061

Delco - #266P, 266N, 265P, 265N, 5015850, 812970, 265J, 820845,

812971, 1116816, 265G, 265H, 1116755, 1116751, 1116809DR, 265B, 1842859, 265C, 1867781, 265F, 265D

Fits: **IHC** – Various Models

6-Volt Saddle Mounted Cutout Relay (Delco Version)

B8001-004	Premium Quality, Made in the USA	\$122.50
B8001-006	Standard Quality	\$38.59



Cutout Relay, 25 Amp, 6 Volt, Works Positive or Negative Ground.

Replaces: IH / Farmall # 46412D

Delco - #266P, 266N, 265P, 265N, 5015850, 812970, 265J, 820845, 812971, 1116816, 265G, 265H, 1116755, 1116751, 1116809DR, 265B, 1842859, 265C,

1867781, 265F, 265D Fits: **IHC** – Various Models

6-Volt Delco Type Voltage Regulator

B8002-013	Premium Quality, USA Made	\$119.75
B8002-014	Standard Quality	\$34.75



6 Volt, Positive Ground,

4 Terminals, Flat Mounting Bracket

Replaces: **IH / Farmall** #354234R91, 376121R91

Delco – 1116807, 1116816, 1118291, 1118308, 1118780, 1118982, 1119575, D645, D657

Prestolite – 8-291, GRX-291

Fits: **IHC/Farmall** – (6 Volt, Tractor Mounted) CUB, A, Super A, AV, Super AV, B, BN, C, Super C, H, Super H, Super HV, M, Super M, ML, Super ML, Super MTA, MV, Super MV, O4, O6, SW4, SW6, SW9, WR9, SWR9, 100, 130, 140, 200, 230, 240, 300, 330, 340, 350, 400

B8002-006	12-Volt Voltage Regulator	\$67.50
------------------	----------------------------------	----------------



12 Volt, 3 Terminal, Negative Ground, Voltage Regulator

IHC/Farmall Replaces: **IH** #121579C1

Fits: 404, 424, 504, 606, 656, 706, 806, 2404, 2424, 2504, 2606, 2656, 2706, 2806

Premium Quality/ USA Made

Replaces: **Delco** # 1119673, 1118219, 1118241, 1118245,

1118252, 1118261, 1118263, 1118264, 1118267, 1118285, 1118317, 1118318, 1118325, 1118328, 1118329, 1118358, 1118367, 1118370, 1118384, 1118385, 1118704, 1118709, 1118716, 1118734, 1118736, 1118749, 1118750, 1118754, 1118759, 1118761, 1118825, 1118826, 1118839, 1118840, 1118882, 1118891, 1118892, 1118893, 1118894, 1118895, 1118896, 1118898, 1118899, 1118900, 1118931, 1118932, 1118933, 1118934, 1118935, 1118936, 1118945, 1118953, 1118967, 1118968, 1118974, 1119000, 1119001, 1119002, 1119003, 1119020, 1119122, 1119123, 1119150, 1119151, 1119155, 1119158, 1119161, 1119162, 1119174, 1119181, 1119182, 1119183, 1119190, 1119192, 1119205, 1119220, 1119234, 1119235, 1119238, 1119239, 1119242, 1119244, 1119247, 1119253, 1119260, 1119261, 1119263, 1119264, 1119277, 1119278, 1119279, 1119280, 1119299, 1119612, 1119621, 1119624, 1119634, 1119641, 1119642, 1119644, 1119645, 1119649, 1119657, 1119663, D617, D618, D620, D626, D611

12-Volt Delco Type Voltage Regulator

B8002-017	Premium Quality, Made in the USA	\$99.75
B8002-018	Standard Quality	\$34.75



12 Volt, 4 Terminals, Flat Mounting Bracket Regulator, Tractor Mounted, Positive or Negative Ground



Replaces: **Delco** - #1118381, 1118779, 1118977, 1118987, 1118993, 1118997,

1118999, 1119576, D646

IHC/Farmall - #376122R91

Prestolite - #8-290

Fits: **IHC/Farmall** - Cub, Cub LO-BOY, 140, F-140, F-140HC, 240, 300, 340, 350, 400, 450, 460, 560, 600, 650, MD, SMD, SMDV, O4, SO4, O6, ODS6, WD6, WD9, WDR9, SWDR9

12-Volt Delco Type Voltage Regulator		
B8002-019	Premium Quality, Made in the USA	\$116.51
B8002-020	Standard Quality	\$34.75
	12 Volt, Generator Mounted Delco Voltage Regulator Fits: IHC/Farmall - Cub, Cub Cadet, Cub Lo-Boy, 154, 184 (With Starter/Generator #1101698) Replaces: Delco - #1118792, 1118991, D649 Prestolite - 8-295, GRX-408	
B8002-038	24-Volt Delco Voltage Regulator	\$119.75
	24 Volt, 4 Terminal, Flat Mounting (Premium Quality, Made in the USA) Replaces: Delco - #1118737, 1118799, 1119185 Fits: IHC - All w/ Delco Generator #1105222, 1106053, 1106855, 1106867, 1106955, 1106971	
B8002-029	Regulator Shock Mount Kit	\$23.95
	Used in Conjunction with #B8002-006, B8002-038 Delco Type Voltage Regulator Replaces: Delco # 1910966, 1911028, 1911034, 1914863, 1915331, D32596	

ALTERNATOR VOLTAGE REGULATORS

B8002-030	Alternator Voltage Regulator	\$14.50
	Heavy Duty, 12 Volt, Negative Ground Alternator Voltage Regulator. This external voltage regulator has 4 spade terminals (field, 2, 3, 4). It is designed for 'B' type circuits in negative ground systems. This is designed for use only in 12 volt systems. For Delco 10DN, & 20DN Fits: International - Fits: [444, 504, 544, 606, 656, 664, 706, 756, 766, 806, 826, 856, 966, 1026, 1066, 1206, 1256, 1456, 1466, 1468, 2444, 2504, 2544, 2656, 2706, 2756, 2806, 2826, 2856, 3800, 3850, 4156, 21026, 21206, 21256, 21456 (With Factory Alternator)], Hydro: Hydro 100 (With Factory Alternator) Replaces: International - #65302C1, 65304C1, 384988R91, 389276R91, 393820R91, 532176R91, 702667C9, 925463C91 Delco - #D630, D635, D663, 1119513, 1119515, 1119508, 1119519, D663, 1119502, 1119516, 1119506, 1119512, 1119515	



GENERATOR BEARING & BRUSH SETS

10181RK	6 Volt, 3 Brush Generator Repair Kit	\$12.75
	Consists of 3 Brushes, 1 Ball Bearing & 1 Bushing 6 Volt., Fits Delco Generator #1101355 & 1101423 IHC / Farmall Fits: CUB, A, Super A, B, C, Super C, H, Super H, I4, I6, I9, M, Super M O4, O6, W4, W6, W9	
10242RK	6 Volt, 3 Brush Generator Repair Kit	\$12.75
	Consists of 3 Brushes, 1 Ball Bearing & 1 Bushing 6 Volt., Fits Delco Generator #1100501, & 1100531 IHC / Farmall Fits: Cub, A, Super A, B, C, Super C, H, Super H, I4, I6, I9, M, Super M, O4, O6, W4, W6, W9	
10341RK	12 Volt, 2 Brush Generator Repair Kit	\$11.75
	Consists of 2 Brushes, 1 Ball Bearing, & 1 Bushing 12 Volt, Fits Delco Generator #1100027, 100401 IHC / Farmall Fits: Farmall Cub, Cub Loboy with 12 Volt Generator	
9199RK	12 Volt IHC/Farmall Cub Lo-Boy 154, 184 Generator Repair Kit	\$15.75
	Consists of 2 Brushes & 2 Ball Bearings With Generator Mounted Regulator 12 Volt, Fits Starter/ Generator #1101698 IHC / Farmall Fits: Farmall Cub Lo-Boy 154, 184	





IDENTIFICATION TAGS

Delco Remy

B9013-004	Delco Remy I.D. Tag (Blank)	\$7.00
	Delco Remy I.D. Tag (Stamped)	\$14.25
	Black Delco-Remy I.D. Tag for Distributors, 6 Volt Starters, & 6 Volt Generators with Rivets, 3/4" 2 5/16"	

B9013-005	Red Delco Remy I.D. Tag (Blank)	\$7.00
	Red Delco Remy I.D. Tag (Stamped)	\$14.25
		Red Delco-Remy I.D. Tag for 12 Volt Starters & 12 Volt Generators with Rivets, 3/4" 2 5/16"
B9013-013	Delco Remy I.D. Tag (Blank)	\$7.00
	Delco Remy I.D. Tag (Stamped)	\$14.25
		Black Delco-Remy I.D. Tag for Distributors, 6 Volt Starters, & 6 Volt Generators with Rivets, 3/4" 2 5/16"

IHC/Farmall

B9013-007	IHC I.D. TAG	\$21.99
		IHC/Farmall Serial Number Tag (Size 2 1/4" x 4") Fits: CUB, A, B, C, H & M (Early Style 1939-49)
B9013-008	IHC I.D. TAG	\$21.99
		IHC/Farmall Serial Number Tag (Size 2 1/4" x 4") Fits: CUB, A, B, C, H & M (Later Style 1950 & Up)
B9013-015	IHC I.D. TAG	\$21.99
		IHC/Farmall Serial Number Tag (Size 2 1/4" x 4") Fits: [Cub, Super W9, Super WD9, Super WDR9, T340, TD340, WR9S, 100, 130, 140, 200, 230, 240, 300, 330, 340, 350, 400, 404, 450, 460, 560, 600, 650, 660 (YEAR 1956 AND UP)], [424, 504, 606, 656 (Thru 1964)], Cub LoBoy: Cub Loboy (Year 1956 & Up, Except 154, 184, 185), Wheatland: 400, 450 (Year 1956 & Up)
B9013-016	IHC I.D. TAG	\$21.99
		IHC/Farmall Serial Number Tag (Size 2 1/4" x 4"). Includes printed 'FC' and mounting screws. Installs on seat base. Fits: C

ALTERNATORS





Delco 10SI Type

B6001-005	6 Volt Alternator	\$166.50
40 Amp, 1 Wire, Positive Ground, 3/8" Pulley		
B6001-012	12 Volt Alternator (1 Wire, 1/2" Pulley)	\$111.25
63 Amp, Low Cut In, For Tractors, Forklifts, & Other Low Engine Speed Applications, 1/2" Belt Width Pulley		
B6001-014	12 Volt Alternator (1 Wire/3 Wire, 1/2" Pulley)	\$129.75
As B6001-002, but has 1/2" Pulley. Fits IHC- 656, 706 Gas, 756, 806 Gas, 826, 966, 1026, 1066, 1206, 1256, 1456, 1466, 1468, 1566, 1568, 2756, 2856		
B6001-015	12 Volt Alternator (1 Wire/3 Wire, 5/8" to 3/4" Pulley)	\$129.75
Fits IHC/Farmall -706 Diesel, 806 Diesel		

Small ND Type

B6002-003	12 Volt Small Denso Alternator (1-Wire)	\$119.75
		40 Amp, 1 Wire Internal Regulator. Will Start Charging with a Much Lower Engine Speed. Comes with a 4 1/2" Housing Diameter, 3/8 To 1/2" Belt width & a 2 1/2" Pulley Diameter. Excellent for Converting a 6 Volt System to 12 Volt. Negative Ground Only & is Self-Excited

ALTERNATOR BRACKETS

B9014-002	IHC/Farmall Alternator Bracket with Adjusting Arm	\$46.99
		Must only use with Alternator #B6002-003. Can Use Existing Belt, Direct Bolt-on. Will Allow Alternator To Fit Under The Hood Without Cutting Fits: Farmall Cub Made in the USA
B9014-003	IHC/Farmall Alternator Bracket with Adjusting Arm	\$55.99
		Alternator Bracket with Adjusting Arm Fits: Farmall A, B, C, Super A, Super C, 100, 130, 200, 230 Power Units: U2, U2A Made in the USA



B9014-004	IHC/Farmall Alternator Bracket with Adjusting Arm	\$49.75
	Will Allow Alternator To Fit Under The Hood Without Cutting Fits: IHC/Farmall H, Super H, I4, O4, W4, 300, 330, 350 Made in the USA	
B9014-005	IHC/Farmall Alternator Bracket with Adjusting Arm	\$49.75
	Will Allow Alternator To Fit Under The Hood Without Cutting Fits: IHC/Farmall M, Super M, I6, O6, W6, 400, 450 Made in the USA	
B9014-015	IHC/Farmall Alternator Bracket with Adjusting Arm	\$59.75
	Fits: IHC/Farmall 140 Made in the USA	
B9014-016	Farmall Alternator Bracket	\$15.75
	Fits: IHC/Farmall 460/560 Gas Made in the USA	

ALTERNATOR CONVERSION KITS

Each Converts from 6-Volt to a 12-Volt Negative Ground Alternator and includes:

- 12-Volt, 1-Wire (Self Exciting) Alternator
- Alternator Mounting Brackets
- 12-Volt, 3.0 OHM, Black Coil
- Instruction Sheet

B9021-007	Farmall Alternator Conversion Kit (Gas Only)	\$182.50
	Fits (gas only): IHC/Farmall A, B, C, Super A, Super C, 100, 130, 200, 230	
B9021-011	Farmall Alternator Conversion Kit	\$199.00
	Fits: IHC/Farmall 140	
B9021-006	Farmall Alternator Conversion Kit (Gas Only)	\$182.50
	<i>Note:</i> Allows Alternator to fit under hood without modification. Fits (gas only): IHC/Farmall H, Super H, I4, O4, W4, 300, 330, 350	

B9021-005	Farmall Alternator Conversion Kit (Gas Only)	\$182.50
	Fits (gas only): IHC/Farmall M, Super M, I6, O6, W6, 400, 450	
B9021-012	Farmall Alternator Conversion Kit (Gas Only)	\$155.25
Fits IHC/Farmall 460 Gas, 560 Gas		
B9021-009	IHC Cub Conversion Kit	\$219.00
	<i>Note:</i> Allows the Alternator to fit under the hood where the original generator would go. Farmall Cub Fits: (all)	

GENERATOR PULLEYS

B9028-027	IHC 2-Piece Adjustable Generator Pulley	\$49.50
	Measures 4.129" Diameter. IHC/Farmall Replaces: #6745D, 6745DA, 6746D, 6746DA Fits: (Gas or LP, with Generator #'s 1101355, 1101423, 1100501) - I4, H, HV, Super H, Super HV, I9, M, Super M, Super MTA, MV, Super MV, O4, O6, OS4, OS6, Super W4, W4, Super W6, W6, W6TA, W9, WR9, WR9S, 400 (gas, up to SN 13673), (LP, up to SN 13458), 300 (up to SN 11002 Farmall, up to SN 2689 Industrial) T6 (gas or LP, with Generator #1101358) W400 (gas, up to SN 1147, with Generator #1100501), W400 (LP, up to SN 1400, with Generator #1100997) 600 & 650 (gas or LP, with Generator #1100997)	
B9028-028	IHC Generator Pulley	\$49.99
	Fits on a 1-1/4" Generator Shaft. Measures 3" Outside Diameter with a 2.104" Overall Length. IHC/Farmall Replaces: #363366R1 Fits: C (Serial #47126 and Up, Using Generator #1100531), [Super A, Super AV (Serial #317192 and Pp, Using Generator I#100531)], [100, 130, 200, 230 (Using Generator #1100531)], 400 (Gas, Serial #13674 and Up), 450 (Gas, Up to Serial #11083), Farmall Rowcrop: 300 (Serial #11003 and Up, Using Generator #1100531), 350 (Up to Serial #13242, Using Generator #1100531), International Utility: 300 (Serial #2690 and Up, Using Generator #1100531), 350 (Gas, LP, Up to Serial #14600, Using Generator #1100996)	

GAUGES

Ammeters, Universal

B9025-002	Ammeter 20-0-20	\$19.99
	Does not have a logo Dimensions: Fits in 2" Diameter Hole 1.850" From Post to Bottom of Bezel	

B9025-005	Ammeter 30-0-30	\$19.99
	Has a black face with white lettering and a chrome bezel. Dimensions: Fits in a 2" Diameter Hole 1.740" From Top of Post to Bottom of Bezel	

B9025-008	Ammeter 60-0-60	\$19.99
	Has a black face with white lettering & a chrome bezel Uses threaded terminals and is dash mounted Used with 12-Volt Alternator Systems Dimensions: Fits in 2" Diameter Hole Measures 1.765" from Top of Post to Bottom of Bezel	

Ammeters, IHC

B9025-015	IHC 20-0-20 Ammeter	\$29.99
	IHC/Farmall Replaces – IH #354473R91. Fits Models: CUB, A, AV, B, BN, C, H, HV, I4, I6, ID6, ID9, M, MV, MD, MDV, O4, OS4, O6, OS6, ODS6, T6, T9, TD6, TD9, W4, W6, WD6, W9, WD9	

B9025-016	IHC 20-0-20 Ammeter	\$29.99
	IHC/Farmall Replaces IH #42383DB, 42383DA, 42383D, 42383DC. Fits Models: A, H, I4, I6, ID6, I9, M, T4, T6, TD6, T9, TD9, TD14, TD18, W4, W6, WD6, WD9 Also Fits Models with Cutout Relays through 1946	

B9025-017	IHC D-0-C Ammeter	\$29.99
	IHC/Farmall Replaces – IH #360053R91, 360053R92, 393334R91, 378424R91 Fits Models: Cub, Cub Lo-Boy 154, Super A, Super C, H, Super H, M, Super M, SMTA, 100, 130, 140, 200, 230, 240, 300, 330, 340, 350, 400, 450, 460, 560, 600, 650, 660	

B9025-030	IHC 60-0-60 Ammeter	\$29.99
	Fits All Models with Alternator	

B9025-054	Charge Indicator Gauge	\$27.99
	Has a Metal base with a Black & White Face with Chrome Bezel. Fits in 2" Diameter Hole. Has green Jewel Lens in Back for Proper Back Lighting. 1.875" From Top of Post to Bezel Bottom. Nitrile Rubber Gasket Included. IHC/Farmall Replaces: 1341322C1, 533990R1, 84203117 Fits: 1066, 1466, 1468, 1566, 1568, 4366, 4386, 766, 966, Hydro: Hydro 100	

Oil Pressure Gauges, IHC/Farmall

B9025-018	IHC Oil Pressure Gauge (0-75 PSI)	\$48.99
	Includes the IHC logo & part number.(threads into cylinder block)1/8 NPT male thread Logo is correct for tractors thru 1946 International – Replaces: 43987DB Fits: A, AV, B, BN, F12, F14, F20, I12, I14, O12, O14, W12, W14 Engine Mounted, All Models 1934 to 1946	

B9025-019	IHC Oil Pressure Gauge (0-75 PSI)	\$41.99
	Shipped with 1/8" male pipe threads International Replaces: 41934D, 41934DB Fits: H, HV, I4, I6, I9, M, MD, MDV, MTA, MTAV, MV, O4, O6, ODS6, OS4, OS6, W4, W6, W6TA, W9, WD6, WD9, WDR9, WR9, WR9S	

B9025-020	IHC Oil Pressure Gauge (0-75 PSI)	\$49.99
	Shipped with 1/8" male pipe threads International Replaces: 41934DB Fits: H, HV, I4, I6, I9, M, MV, O4, O6, OS4, OS6, Super H, Super HV, Super M, Super MTA, Super MV, Super W4, Super W6, Super W6TA, Super W9, T6, T9, TD6 (up to SN: 22501), W6, W9, WD6, WDR9, WR9, Crawler: T14	

B9025-021	IHC Oil Pressure Gauge (0-45 PSI)	\$48.99
	Screw-in type Gauge that mounts to the engine or governor. Includes the IH Logo & the IH Part number. The back of the Gauge has a 1/8" NPT Male thread International Replaces: 31041DB Fits Models: Cub (Early; up to 1954)	

B9025-022	IHC Oil Pressure Gauge (0-75 PSI)	\$43.99
	Screw-in type Gauge that mounts to the engine or governor. Includes the IH Logo & the IH Part number. The back of the Gauge has a 1/8" NPT Male thread International Replaces: 43987DB Fits: A, B, C, Super A, Super A-1(1947-1954), Super C	

B9025-023	IHC Oil Pressure Gauge (0-75 PSI)- Engine-Mounted	\$45.99
	Oil Pressure Gauge with IH Logo, Engine-Mounted International Replaces IH #536967R1, 528245R91, 393487R91, 364665R91 Fits: Cub (1955 & Up), 100, 130, 140, 200, 230	

B9025-024	IHC Oil Pressure Gauge (0-75 PSI)- Dash-Mounted	\$45.99
	Oil Pressure Gauge with IH Logo, Dash-Mounted IHC/Farmall- Replaces: #362039R91, Serviceable: 536962R2 Fits: 240, 300, 350, 330, 340, 400, 450 (Gas/Diesel) 600, 650 (Gas/LP) 3514, 3616, 3800, 3850, T340, T5, TD340, TD5, Crawler: 500	

B9025-025	IHC Oil Pressure Gauge (0-45 PSI)	\$45.99
	Dash-Mounted Oil Gauge with 1/8" NPT Male Pipe Threads IHC/Farmall Replaces: #258634R91, #702027C1 Fits: ID6, MD, MDV, Super MD, [Super MTA, W6TA (Diesel)], Super WD6, Super WD9, TD14, TD14A, TD15, TD20, TD25, TD9, TD18, TD18A, TD24, , TD30, TD6, WD6, WD9 (Serial #12,426 & Up), WDR9 (Serial #12,426 and Up), UD14, UD18, UD24	

Oil Pressure Gauges

B9025-004	Universal Oil Pressure Gauge (0-50 PSI)	\$21.99
	Has 1/8" NPT Male Threads, studs, & a bracket. No logo included. Dash-mounted, requires a 2" diameter hole. IHC/Farmall Fits: ID6, ID9, MD, MDV, MTA, ODS6, Super MD, Super MDV, Super MTA, Super WD6, Super WD6TA, Super WD9, TD6-61, TD9, UD14, UD18, UD24, UD6, UD9, WDR9, 350, 400, 450, 600, 650 (Diesel), WD9, 460, 560, 660 (Gas, Lp, & Diesel), 3616, 3800, 3850 (Gas & Diesel)	

B9025-001	Universal Oil Pressure Gauge (0-80 PSI)	\$24.99
	Has 1/8" NPT Male Threads, studs & a bracket. No logo included. Dash-mounted, requires a 2" diameter hole. IHC/Farmall Fits: H, HV, I4, I6, I9, M, MTA, MV, O4, O6, OS4, OS6, Super H, Super HV, Super M, Super MTA, Super MV, Super MVTA, Super W4, Super W6, Super W6TA, T340, T4, T5, T6, T6-61, T6-62, T9, TD340, W4, W6, W9, WR9, WR9S, 240, 300, 330, 340, 350, 400, 450, 460, 500, 560, 600, 650, 660, 3514, 3616, 3800, 3850, ID6, ODS6, WD6 (To Sn: 4926)], ID9, WD9, WDR9 (To Sn: 12425), MD, MDV (To Sn: 8246)	

B9025-089	IHC/Farmall Engine-Mounted Oil Pressure Gauge (0-45 PSI)	\$45.99
	Mounted either to the engine or governor 1/8" NPT Male Thread IHC/Farmall Replaces: #362177R92, 364663R92, 364665R92 Fits: Cub (1955 and up), Cub Loboy, 154, 184, 185	

Oil Pressure Gauge, Line Kit

B9026-001	Oil Pressure Gauge Line Kit	\$29.99
	6 FT copper 1/8" line --- Kit includes: (2) 5/16 - 24 UNF nut, (2) compression sleeves, (1) 1/8 - 27 NPTF female to 5/16" - 24 UNF male adapter --- Note: Depending on application customer may be required to purchase other fittings.	

B9026-004	Oil Pressure Gauge 1/4" to 1/8" NPT Adapter Fitting	\$15.99
	Adapter Fitting for Oil Gauges - 1/4" to 1/8" NPT. IHC/Farmall Replaces: #257523R1, 29898D Fits: H, HV, I9, ID9, M, MD, MDV, MTA, MV, O4, O6, ODS6, OS4, OS6, Super H, Super HV, Super M, Super MD, Super MDV, Super MV, Super WD9, Super WDR9, T340, T9, TD6, TD9, W4, W6, W6TA, W6TA (DSL), W9, WD6, WD9, WR9, WR9S, 300, 350, 400, 450, 460, 560, 600, 650, 660, Wheatland: 400, 450	

Water Temperature Gauges, Universal

B9025-006	Water Temperature Gauge	\$34.99
	Includes an Aluminum Sealing Washer to Seal Probe, 1/2" NPT Pipe Bushing, and 1.279" Probe Length. IHC/Farmall Fits: [C, Super C, T340, T4, T5, T6, T6-61, T9, TD340, TD5, TD6, TD6-61, TD9, 200, 230, 240, 2444, 300, 330, 340, 3414, 3444, 350, 3514, 400, 444, 450, 650 (And Other Models Using 60" Capillary Lead)]	

B9025-007	Universal Water Temperature Gauge	\$34.99
	Dash-mounted (parts included), 72" long heavy duty capillary tube included (check length before ordering) IHC/Farmall Fits: [C, Super C, T14, T340, T4, T5, T6, T6-61, T6-62, T9, TD14, TD14A, TD15, TD15-151, TD18, TD18A, TD20, TD340, TD5, TD6, TD6-61, TD6-62, TD9, TD9-91, TD9-92, TD9B, 200, 230, 240, 2444, 300, 330, 340, 3414, 3444, 350, 3514, 3616, 3800, 3850, 400, 444, 450, 460, 500, 560, 660 (And Others Using 72" Or Shorter Capillary Lead)]	

Cluster/Combination Gauges

B9025-051	IHC Oil & Temperature Cluster Gauge Assembly	\$159.99
	Lighted. 32-244 Ohm Range. Comes with Lead & 3/4" NPT Thread Probe. Fits in 4 1/4" hole. IHC/Farmall Replaces: #1546481C1, 534057R2 Fits: [1066, 1466, 1468, 1566, 1568, 4366, 4386, 4568, 4586, 766, 966 (Diesel)], Hydro: Hydro 100 (Diesel)	

Water Temperature Gauges, IHC

B9025-055	IHC Water Temperature Gauge	\$73.99
	Has a Metal Base with White "Cool", Green "Run". & Red "Hot" Zones with IH Logo Displayed. Fits in 2" Diameter Hole. 1.450" From Top of Post to Bezel Bottom. 1.4" Probe End Length. 19-1/4" Capillary Lead. IHC/Farmall Replaces: #53619DB, 53619DC Fits: B, BN, Super A, Super A-1, Super AV, Super AV-1, [100, 140 (serviceable for)], 130 (serviceable for)	

B9025-070	IHC Fuel & Water Temperature Cluster Gauge Assembly	\$159.99
	Lighted. 32-244 Ohm Range. Comes with 80" Capillary Lead & 11/16" x 24 UNF Thread Probe. Fits in 4 1/4" hole. IHC/Farmall Replaces: #1546480C1, 382733R93, 396380R91, 396380R91, 397937R92, 397939R92, 539293R91 Fits: Diesel Only: 1026, 1206, 1256, 1456, 4166, 4186, 666, 686, Hydro 70, Hydro 86; Following Gas & Diesel: 544, 656, 706, 756, 806, 826, 856; Serviceable for following Gas Model (gauge face is different for temperature & will have a longer capillary tube): 404, 424, 444, 606; Serviceable for following Gas and Diesel Models (gauge face is different for temperature & will have a longer capillary tube): 504	

B9025-026	IHC Water Temperature Gauge	\$57.99
	Has a 72" Lead IHC/Farmall Replaces: #393481R91, 393476R91, 369849R91, 53690R2, 353868R91 Fits Models: C, Super C, 200, 230, 240, 300, 330, 340 (GAS), [350, 400, 450, 460, 560, 660 (Gas & diesel)]	

Fuel Gauges, IHC

B9025-052	IHC Fuel Gauge	\$45.99
	32-244 Ohm Range. 12 Volt Negative Ground. Fits in 2" Diameter Hole. Has Green Jewel Lens in Back for Proper Back Lighting. 2.250" From Top of Post to Bezel Bottom. Has Nitrile Rubber Gasket. IHC/Farmall Replaces: #378426R91, 533992R1, H142794 Fits: 1066, 1466, 1468, 1566, 1568, 4366, 4386, 4568, 4586, 766, 966, Hydro: Hydro 100	

B9025-027	IHC Water Temperature Gauge (up to 1946)	\$52.99
	Has 16" Lead IHC/Farmall Replaces: #63783D Fits Models up to 1946: H, I4, I6, I9, ID6, ID9, M, O4, O6, TD6, W4, W6, W9, WD6, WD9	

B9025-088	Fuel Gauge (Rochester Style)	\$45.99
	Replaces Factory Rochester gauge, 12-Volt, Negative Ground, 0 - 70 OHMS, Ground wire must be connected to clamp stud to sender. IHC/Farmall Replaces: #369607R91 Fits: 340, 460, 560, 660	

B9025-028	IHC Water Temperature Gauge (1947 and up)	\$49.99
	Has 16" Lead IHC/Farmall Replaces: #67135D Fits Models 1947 & Later: H, I4, I6, I9, ID6, ID9, M, O4, O6, ODS6, OS4, OS6, Super H, Super M, Super MD, Super MTA, Super W9, Super WD6, Super WD9, TD6, W4, W6, W9, WD6, WD9, 100, 130, 140	

Air Filter Gauges, IHC

B9025-053	Air Filter Change Indicator	\$37.99
	<p>Has Green (Clean), Red (Clogged) Filter Zones, and Green Jewel Lens in Back for Proper Back Lighting. Fits 2" Diamr Hole. 2.250", Top of Post to Bezel Bottom. Nitrile Rubber Gasket.</p> <p>IHC/Farmall Replaces: #1341364C1, 389871R91, 397942R91, 533991R1, 536230R1</p> <p>Fits: Hydro 100, Hydro 70, Hydro 86, 1026, 1066, 1206, 1256, 1456, 1466, 1468, 1566, 1568, 21026, 21206, 21256, 21456, 2544, 2656, 2706, 2756, 2806, 2826, 2856, 4100, 4156, 4166, 4366, 4386, 4568, 4586, 544, 656, 664, 666, 686, 706, 756, 766, 806, 826, 856, 966</p>	

Touch Control Gauges, IHC

B9025-029	IHC Touch Control Temperature Gauge	\$93.99
	<p>IHC Replaces: IH #355840R91, 355841R91, 356465R91, 356466R91 Fits Models: A, Super A, C, Super C, 100, 130, 140, 200</p>	

Glow Plug Gauges, IHC

B9025-065	IHC Glow Plug Meter	\$45.99
	<p>Fits a 2" Hole. Includes Bracket, Mounting Studs, and IH Logo.</p> <p>IHC Replaces: #370380R91, 370380R92, 378352R91, 378352R91, 404740R1, 404740R1 Fits Diesel: 340, 424, 460, 504, 560, 606, 656, 660, 706</p> <p>Industrial: 2500, 2504, 2606, 2656, 2706, 3514, 3616, TD340 (diesel)</p>	

Tachometer Gauges, IHC

B9025-073	IHC Tachometer	\$104.50
	<p>Outer Housing Diameter Measures 4.22" and Length Measures 2.25"</p> <p>IHC Replaces: #103151A1, 388588R91, 388589R91, 66748C1 Fits: 706, 806, 1206, 21206</p>	

B9025-083	IHC Tachometer	\$59.99
	<p>Measures 3.75" outside diameter at bezel and 3.3170" outside diameter of housing. Has a clockwise rotation.</p> <p>IHC Replaces: #66455C1, 3121926R91, 3125106R92 Fits: 454, 464, 484, 485, 584, 585, 674, 684, 784, 785, 884, 885, 2400, 2500A, Hydro 84, Hydro 574</p>	

B9025-090	IHC Tachometer	\$112.99
	<p>Housing Outer Diameter is 3.330" Housing Length is 2.060"</p> <p>IHC/Farmall Replaces: #383092R91, 383093R91 Fits (gas/diesel): 460, 560</p>	

B9025-092	IHC Tachometer	\$164.99
	<p>4.227" dash opening OD 4.240" outer housing diameter 2.235" housing length</p> <p>IHC/Farmall Replaces: #103151A1, 107368C3, 67679C2, 84212503 Fits: 766 (diesel), 786 (Early), 886 (Early), 966 (with gear drive), 986, 1066 (with gear drive), 1086, 1466 (with gear drive), 1486 (Early)</p>	

Tachometer Drive Cable

B9026-006	Tachometer Drive Cable, 63"	\$32.99
	<p>Restoration Quality. Drive Cable for Tachometers. Measures 63" Outer Sheath Length. 5/8"-18 x 7/8"-18 Threads.</p> <p>IHC/Farmall Replaces: #371245R91, 401830R91, 402240R2 Fits: 340 (Diesel), 460, 544 (Diesel), 560 (Gas/Diesel), 660 (Gas/Diesel), 886 (D-360 Engine), 986, 1086, 1468, 1486, 1568, 3688</p>	

B9026-009	Tachometer/Speedometer Cable, 87"	\$32.99
	<p>Measures 87" long.</p> <p>IHC/Farmall Replaces: #396386R91 Fits: 706, 756, 826, 966, 1066, 1466, 1566, 2756, 2826, Hydro 100</p>	

B9026-011	Tachometer Cable, 43"	\$34.99
	<p>Has a 43" long Nylon Sheath with 5/8 - 18 x 7/8 - 18 threads with squares on both ends.</p> <p>IHC/Farmall Replaces: #370197R91, 397016R92 Fits: Cub, Cub Loboy, 606, 2606 As a speedometer for Hydro models: 100, 826, 966, 1026 Utility: 340, 460, 504</p>	

B9026-012	Tachometer Cable, 61 1/4"	\$36.99
	<p>61 1/4" Inner Cable Length with Squared Ends, 5/8 - 18 x 7/8 - 18 threads, Metal Sheath</p> <p>IHC/Farmall Replaces: #364375R91, 368107R91 Fits Rowcrop: 300, 350, 460</p>	

B9026-014	Tachometer Cable, 80"	\$36.99
	<p>80" Tip to Tip with Squared Ends, 5/8 - 18 x 7/8 - 18 threads, Metal Sheath IHC/Farmall Replaces: #89159R91, 341210C91, 384845R92, 385082C91, 387916R91, 393328R91, 393328R92, 393328R93 Fits (Diesel): 600, 650, 666 (with D310 engine), 766, 806, 856, 1026, 1206, 1256, 1456, 3088, 3288, 4166, 4186, 4366</p>	

B9026-016	Tachometer Cable, 58 3/8"	\$27.99
	<p>58 3/8" inner cable length, 5/8" - 18 threads on small threaded fitting, 7/8" - 18 threads on large threaded fitting, Square cable on both ends IHC/Farmall Replaces: #384843R91, 393326R92, 529234R1 Fits: 454, 464, 544 (Farmall Rowcrop only), 574, 656 (Farmall Rowcrop only, gas or diesel), 666, 674 (diesel), 686, 706, 756, 766, 784, 785, 806, 826, 856 (without cab) - 385, 484, 485, 584, 585, 684, 685, 884, 885 (as a speedometer cable) - Hydro 70, Hydro 84, Hydro 86</p>	

FUEL SENDING UNITS

B9037-005	Fuel Sending Unit For Stewart Warner Fuel Gauge	\$47.99
	<p>32-244 Ohms. 2 1/2" Bolt Circle. For Positive and Negative Ground Systems. IHC/Farmall Replaces: 378427R91, 378427R94, 84203050 Fits: 544 (GAS Rowcrop only), 560 & 660 (w/ Stewart Warner or Rochester Fuel Gauge, part #369607R92 Only), 656 (Rowcrop only), 666, 686, 706, 756, 766, 806, 826, 856, 966, 1026, 1066, 1206, 1256, 1456, 1466, 1468, 1566, 1568, [2706, 2756, 2806, 2826, 2856, 21026, 21206, 21256, 21456, (GAS)], Hydro 100, Hydro 70, Hydro 86</p>	

B9037-007	Fuel Sending Unit for Rochester Style Fuel Gauge	\$56.99
	<p>Only Used with Rochester Gauges, 0 OHMS empty - 70 OHMS full, 15" Deep, Works on negative or positive ground systems IHC/Farmall Replaces: 1341373C1, 369608R91, 369608R92, 370376R92, 84203084, 842708260 Fits: 444, 460, 560, 660, 2444</p>	

TACHOMETER DRIVES

B9035-001	Tachometer Drive Assembly	\$46.50
	<p>Has a 14 Tooth to 43 Tooth Gear Ratio. Includes Gaskets. IHC/Farmall Replaces: #367150R91 Fits: 350 Diesel Row Crop</p>	

B4008-019	Distributor/ Tachometer Drive Housing Block-Off Plate	\$8.99
	<p>Used to Cover Tachometer Drive. Includes Gasket. IHC/Farmall Replaces: #363764R1, 363765R1 Fits: A, A1, AV, AV-1, B, BN, C, Cub, Cub Loboy, H, HV, I4, I6, I9, ID6, ID9, M, MD, MDV, MTA, MTA, MV, O4, O6, ODS6, OS4, OS6, Super A, Super AV, Super C, Super H, Super HV, Super M, Super MD, Super MDV, Super MDV-TA, Super MTA, Super MTA, Super MV, Super MVTA, Super W4, Super W6, Super WD6, Super WD6TA, Super W9, Super WD9, W4, W6, WD6, W6TA, WD9, WDR9, WR9S, 56T, 56W, 57T, 57W, 100, 130, 140, 154, 184, 185, 200, 201, 240, 300, 330, 340, 350, 400, 404, 424, 444, 450, 504</p>	

IGNITION SWITCHES & PARTS

Push/Pull Switches

B5002-008	Push/Pull Magneto Switch, 1 Screw Terminal	\$44.99
	<p>Push/Pull 1 Prong Magneto Switch, Original Design, Includes Knob Mounting Stem 9/16"-18 Thread Knob #10/32 Thread IHC/Farmall Replaces: #54207DB Fits: A, AV, B, BN, C, Cub, H, HV, I4, I6, M, MD, MV, O4, O6, ODS6, OS4, OS6, Super A, Super AV, Super C, Super H, Super M, Super MD, Super MTA, T6, W4, W6, W9, WD6, WD9, WDR9, WR9, 100, 130, 140 (up to sn 26800), 200, 230, J4 Magneto</p>	

B5002-009	Push/Pull Battery Ignition Switch, 2 Screw Terminals	\$44.99
	<p>Push/Pull Battery Ignition Switch, Original Design, Includes Knob Mounting Stem 9/16"-18 Thread Knob #10/32 Thread IHC/Farmall Replaces: #62801DC Fits: A, AV, B, BN, C, Cub, H, HV, I4, I6, M, MD, MV, O4, O6, ODS6, OS4, OS6, Super A, Super AV, Super C, Super H, Super M, Super MD, Super MTA, [T4, T5 (up to SN: 3087)], T6, T9, TD14, TD14A, TD15 (150 Series), TD18, TD18A, TD20 (200 Series), TD6, TD9, W4, W6, W9, WD6, WD9, WDR9, WR9, 100, 130, 140 (up to Sn 26800), 200, 230</p>	

B5001-004	Push/Pull Knob	\$7.99
	#10/32 Threads. Interchangeable knob with #B5002-008, B5002-009	

B5002-015	1-Terminal Push-Pull Magneto Ignition Switch (OEM)	\$23.99
	Replaces: AGCO – #70213140V	

B5002-001	2 Position Push/Pull Switch	\$7.75
	OFF/ON Universal 2-Position Push/Pull (2 Screw Terminals) Mounting Stem 3/8"-32 Thread Knob #10/32 Thread	

Key Switches

B5003-001	2 Position Battery Key Switch	\$14.75
	Universal OFF/ON 2 Position Key Switch (For Battery Ignition) (2 Screw Terminals) Mounting Stem 3/4"-20 Thread	

B5003-005	4 Position Ignition Key Switch	\$39.99
	Can replace the 4 terminal switch. 2 battery terminals, 5 Spade Terminals, OEM Style Delco Remy 995" Diameter Threaded End. Includes 2 Keys & Jam Nut IHC/Farmall Replaces: #300557R91, #1116629, #361998R93 Fits: 300, 400, Wheatland:400 *Note: Replaces the 4-terminal IH switch. Original switch had 2 separate wires that went to the BAT terminal. On the new switch there are 2 BAT terminals, just hook one wire to each terminal. *Wire Terminals must be changed to plug in style ends.	

B5003-006	Ignition Key	\$4.99
	Key For Above Part, #B5003-005. Brass Finish Fits Listed Models Using Delco Switch IHC/Farmall -300, 400, Wheatland: 400	

B5003-011	Ignition Key Switch	\$43.99
	Includes 1 Key, 2 Nuts, and 1 Lockwasher. Designed for 0.800" hole diameter. International Replaces: 60736C3, 60736C2, 60736C1 Fits: Cub (Sn #239827 And Up), Cub Lo-Boy 154, 140 (Sn #45001 And Up), 154, 184	

B5003-017	4-Position Ignition Key Switch	\$16.99
	2 Keys Included. 6 Spade Terminals: 2 are .375" Wide; 4 are .250" Wide. Threaded end is .625" Replaces: Delco - #1533514 IHC/Farmall - #3107556R92, 3107556R93 Fits: 485 (Up to Serial #15000), 585, 685, 785	

B5003-022	3-Position Ignition Key Switch	\$19.99
	2 Keys Included. 6 Spade .250" Terminals. Fits in .775" diam. hole. IHC/Farmall Replaces: #529800R91, 529800R91GV, 529800R92 Fits: 354, 385, 454, 464 (Up to Serial #109150), 484, 485 (Serial #15001 & Up), 574 (Up to Serial #114908), 584, 674 (Up to Serial #108104), 684, 784, 884, Hydro 84; Industrial: 260A, 2300, 2400, 2500 (Up to Serial #114908)	

B5003-008	Ignition Key Switch	\$24.99
	Includes 2 Keys. 2 Spade Terminals. Fits 0.800" diameter hole. IHC/Farmall Replaces: #403562R2, 379594R92, 370375R91, 636365R91, 366313R91 Fits: Cub (sn 224401 - 239826, w/ battery ignition), [T4, T5, TD5 (SN: 3088 & up)], 100, 140 (sn 26,801 – 45,000), 240, 330, 340, 350, 404, 424, 444, 450 (SOME), 460, 504, 544, 560, 600, 606, 650, 656, 664, 666, 686, 706, 756, 766, 806, 826, 856, 966, 1026, 1066, 1206, 1256, 1456, 1466, 1468, 1566, 1568, 2404, 2424, 2444, 3444, 3514, 3616, 4100, 4156, 4166, 4186, 4366, 4386, IHC Combine: 615, 715, 815, 915; Wheatland: 450, Cub LoBoy: Cub Loboy (sn 18701 and up, w/ battery ignition), Hydro 100, Hydro 70, Hydro 86	

B5003-020	Ignition Key	\$6.99
	Key For Above Part, #B5003-008. IHC/Farmall Replaces: #131313C1, 382458R1 Fits: Industrial - 2404, 2424, 3444, 3514, 3616 Lawn & Garden - Cub Cadet: 100, 102, 104, 105, 106, 107, 108, [109, 128, 129, 149, 169, 76, 86 (SN: 400001 & Up)], 122, 123, 124, 125, 126, 127, 147, 70, 71, 72, 73, Cub Cadet Tractor - Cub (Late), 100, 1026, 1066, 1086, 1206, 1256, 140, 1456, 1466, 1468, 1486, 154, 1566, 1568, 1586, 184, 185, 240, 2400, 2500, 3088, 3288, 3388, 340, 3488, 350, 3588, 3688, 3788, 404, 4100, 4156, 4166, 4186, 424, 4366, 4386, 444, 450, 454, 4568, 4586, 460, 464, 4786, 484, 504, 5088, 5288, 544, 5488, 560, 574, 584, 606, 6388, 650, 656, 6588, 660, 664, 666, 674, 6788, 684, 686, 706, 7288, 7488, 756, 766, 784, 786, 806, 826, 856, 884, 886, 966, 986, Cub LoBoy: Cub Loboy (Late), Hydro: Hydro 100, Hydro 186, Hydro 70, Hydro 84, Hydro 86	

LIGHT SWITCHES & PARTS

B5010-001	IH 4-Position Cutout Light Switch	\$84.99
 <p>Restoration Quality 4 Position Light Switch for IHC & McCormick Deering Tractors. Looks and Works like the Original Replaces: IHC-#57310DX, 57310DY, 4789DX Delco-#1994019. IHC/Farmall & McCormick Deering</p> <p>Fits: Models with <u>Cut-Out Relay</u> on Generator Cub (up to Serial #115402), A, AV, Super A (up to Serial #345198), B, BN, C, Super C (up to Serial #47125), H & HV (up to Serial #340953), I4, I6, I9, ID6, ID9, M & MV (up to Serial #229,910), O4, OS4, O6, OS6, T6, TD6, T9, TD9, W4, W6, WD6, W9, WR9, WD9</p>		

3-Position Rotary Light Switch		
B5010-002	6-Volt (Replaces #354236R91)	\$49.99
B5010-003	12-Volt (Replaces #1994050, 263691R92)	\$47.99

3-Position Rotary Light Switch		
 <p>6 or 12 Volt Rotary Light Switch with Old Style Knob (3-Position) *Some switches may have a different appearance, however the knob is the only visible portion and is identical to the Original.* Note: Switch has been modified to replace earlier 3 & 4 Position Switches (6 & 12 Volt) IHC/Farmall Replaces: #1994038</p> <p>Fits Models with <u>Voltage Regulators</u>. Select 6 or 12 volt: A, AV, B, BN, C, H, HV, I4, I6, I9, ID6, ID9, M, MD, MDV, MV, O4, O6, OS4, OS6, Super A, Super A-1, Super AV, Super AV-1, Super C, Super H, Super HV, Super W4, W4, W6, W9, WD6, WD9 Cub (up to SN #224,400), Cub Lo-Boy (up to SN #18,700) Super M, Super MD, Super MDV, Super MV, Super W6, WDR9, WR9</p>		

B5010-011	3-Position Rotary Light Switch	\$49.99
 <p>6 Volt Rotary Light Switch, OEM, Switch Manufacturer Considers 'OFF' as 1 Position IHC/Farmall Replaces: #362111R91, 363130R91 Fits: [100, 130, 200, 230, 330 (with 6 volt systems using a voltage regulator)], [300, 400 (gas, with 6 volt systems using a voltage regulator)], 350 (Gas up to SN: 13242, with 6 volt systems using a voltage regulator), 450 (Gas to SN: 11083, with 6 volt systems using a voltage regulator), Wheatland: 400 (gas, with 6 volt systems using a voltage regulator), 450 (Gas up to SN: 1350, with 6 volt systems using a voltage regulator)</p>		

B5010-015	3 Position Rotary Light Switch (Body Only)	\$47.99
 <p>12 Volt Rotary Light Switch, OEM, Switch Manufacturer Considers 'OFF' as 1 Position. Body ONLY. Does Not Include Knob. IHC/Farmall Fits: [A, AV, BN, C, Cub, H, HV, I4, I6, I9, ID6, ID9, M, MD, MDV, MTA, MV, O4, O6, ODS6, OS4, OS6, Super A, Super AV, Super AV-1, Super C, Super H, Super HV, Super M, Super MD, Super MDV, Super MV, Super W6, Super W6TA, Super WD6, Super WD9, Super WDR9, W4, W6, W9, WD6, WD9, WDR9, WR9, WR9S, 100, 130, 140, 200, 230, 240, 300, 330, 340, 400, 450, 460, 560, 660 (with Regulator Only)], Super W6TA (DSL, with Regulator Only), Cub LoBoy: Cub Loboy (with Regulator Only), [Wheatland: 400, 450 (with Regulator Only)]</p>		

B5010-016	3 Position 12 Volt Rotary Light Switch	\$49.99
 <p>12 Volt Rotary Light Switch With New Style Knob (3 Position). *Some switches may have a different appearance, however the knob is the only visible portion and is identical to the Original.* IHC/Farmall Replaces: #363131R91 Fits Only Tractors with Voltage Regulators: [300, 350, 400, 450 (LP, with 12 Volt System and a Voltage Regulator)], [350, 450 (Diesel, with 12 Volt System and a Voltage Regulator)], 350 (Gas, Serial #13243 & Up, with 12 Volt System and a Voltage Regulator), 450 (Gas, Serial #11084 & Up, with 12 Volt System and a Voltage Regulator), [600, 650 (with 12 Volt System and a Voltage Regulator)], [Wheatland: 400, 450 (Diesel, with 12 Volt System and a Voltage Regulator)], [400, 450 (LP, with 12 Volt System and a Voltage Regulator)], 450 (Gas, Serial #1351 & Up, with 12 Volt System and a Voltage Regulator)</p>		

4-Position Rotary Light Switch		
B5010-004	6 Volt	\$49.99
B5010-005	12 Volt	\$49.99
 <p>4-Position Rotary Light Switch, OEM IHC/Farmall Replaces #371464R91 Fits: Cub (Serial #210,001 to 224,400), Cub Lo-Boy (Serial #10,001 to 18,700), 140 (up to Serial #26,800), 240, 340, 460, 500, 500 Crawler, 560, 660, T340 (up to Serial #5395), T4, T5, TD5</p>		

B5010-006	4-Position Rotary Light Switch	\$49.99
	<p>4 Position Rotary Light Switch, OEM 5 Outer Terminals & Resistor IHC/Farmall Replaces #376851R91, 376851R92 Fits: 2300A, 2400A, 2500A, Cub (SN: 224401 & up), Cub LoBoy 154, [T340, TD340 (SN: 5396 & up)], 140 (SN: 26801 to 62471), 154, 184, 185, 354, 404, 424, 444, 454, 464, 504, 574, 606, 674, 706, 806, 1206, 2424, 2444, 3414, 3444, 3514, 3600, 3616, 3800, 3850, 4100, 4156, Cub LoBoy: Cub Loboy (SN: 18701 & up) Combine: 205, 315, 403 (Hillside (Serial #1323 & up)), 403 (Serial #16130 & up), 503 (Serial #6288 & up) Miscellaneous - Cotton Picker: 616, 622, Scraper: E200</p>	

B5010-013	4-Position, 12-Volt Rotary Light Switch	\$48.95
	<p>OEM, Has 5 Terminals with 0.670" O.D. Thread. IHC/Farmall Replaces: #403571R1, 403571R2 Fits: 1026, 1066, 1256, 1456, 1466, 1468, 1566, 1568, 4166, 4366, 544, 656, 664, 666, 756, 766, 826, 856, 966, Hydro: Hydro 100, Hydro 70</p>	

B5010-019	4-Position, 12-Volt Rotary Light Switch	\$51.99
	<p>Has 6 spade terminals, Outside diameter thread: 0.685" IHC/Farmall Replaces- #107200C1, 107200C2, 1-1288 Fits: Hydro 84, Hydro 86, Hydro 186, 140 (SN: 62,472 and up with alternator), 384, 464 (SN: 109,151 and up), 484, 574 (SN: 104,909 and up), 584, 674 (SN: 108,105 and up), 684, 686, 784, 786, 884, 886, 986, 1086, 1486, 1586, 3088, 3288, 3488, 3588, 3688, 3688 High Clearance, 3788, 4186, 4568, 5088, 5288, 5488, 6388, 6588, 6788</p>	

B9017-077	Rear Combo Light Switch with Knob	\$18.50
	<p>has 3 Screw Terminals) International Fits: A, AV, B, BN, C, Cub, H, HV, I4, I6, I9, M, MD, MDV, MV, Super A, Super C, Super H, Super M, Super W4, Super W6, Super W9, W4, W9, WD9, WDR9, 100, 130, 140, 200, 230, 240, 300, 330, 340, 400, 450, 600, 650, <u>Wheatland</u>: 400, 450 Fits Lights- #B9016-018, B9016-021, B9016-032, B9016-033</p>	

B5001-005	Rear Combo Light Switch Knob	\$6.75
	<p>Black Knob Used With #B9016-018, #B9016-021, #B9016-032, #B9016-033. Replaces – IHC/Farmall: #359773R91 Fits – IHC/Farmall: [A, A1, AV, B, BN, C, Cub, H, HV, M, MD, MTA, Super A, Super C, Super H, Super HV, Super M, Super WD9, WDR9, WR9S, 100, 130, 140, 200, 230, 240, 300, 330, 340, 400, 450, 600, 650 (OEM STYLE)], 350 (Rowcrop, OEM STYLE), [Wheatland: 400, 450 (OEM STYLE)], Cub LoBoy: Cub Loboy (OEM STYLE)</p>	

B5001-011	IHC New- Style Knob for Rotary Light Switches	\$6.99
	<p>Made to OEM Manufacture Specs. New Style Arrow Design. IHC/Farmall Replaces: #1930685, 21367D Fits: Cub (Serial #210001 & Up), T340, T4, T5, TD340, TD5, 100, 1026, 1066, 1206, 1256, 130, 140, 1456, 1466, 1468, 154, 1566, 1568, 184, 185, 200, 230, 2300A, 240, 2400A, 2424, 2444, 2500A, 300, 330, 340, 3414, 3444, 3514, 354, 3600, 3616, 364, 3800, 3850, 400, 404, 4100, 4156, 4166, 4186, 424, 4366, 4386, 444, 450, 454, 460, 464, 504, 544, 560, 574, 606, 656, 660, 664, 666, 674, 686, 706, 756, 766, 806, 826, 856, 966, Crawler: 500, Cub LoBoy: Cub Loboy (Serial #10001 & Up), Hydro: Hydro 100, Hydro 70, Hydro 86</p>	

B5001-012	IHC Old Style Light Switch Knob	\$8.99
	<p>Made to OEM Specs. Zinc Plated. IHC/Farmall Replaces: #57313D Fits: A, AV, B, BN, C, Cub, H, HV, I4, I6, I9, ID6, ID9, M, MD, MDV, MV, O4, OS4, Super A, Super AV, Super C, Super H, Super HV, Super M, Super MD, Super MDV, Super MV, Super W4, Super W6, T6, T9, TD14, TD14A, TD15 (150 Series), TD18, TD18A, TD6, TD9, W4, W6, W9, WD6, WD9, WDR9, WR9</p>	

B5001-010	Metal Rear Combo Light Switch Knob	\$9.99
	<p>Fits Rear Combo Light #B9016-018, #B9016-021, #B9016-032, #B9016-033, and Light Switch #B9017-077. Constructed of Metal with Knurled Surface and Coated in White Zinc. Has a Set Screw. .252" Hold Diameter with .500" Outer Diameter and is .509" in Length. IHC/Farmall Replaces: #355423R91 Fits: A, AV, B, BN, C, H, HV, M, MD, MDV, [MTA, W6TA (DSL)], MTA, MV, Super A, Super A-1, Super AV, Super C, Super H, Super HV, Super M, Super MD, Super MDV, Super MV, Super W4, Super WD9, Super WDR9, W4, W6, W6TA, W9, WD6, WD9, WDR9, WR9, WR9S, [100, 450 (SERVICEABLE)]</p>	

ORIGINAL LIGHT SWITCH PARTS

B5011-001	Light Switch Dimmer Coil	\$15.99
	<p>Used on all Models With Delco 3 & 4 Position Light Switch IHC/Farmall Replaces: IHC #47889D, Delco #814545 Fits: Cub (Up to Serial #210,000), A, Super A, B, BN, C, Super C, H, SH, I4, I6, ID6 I9, ID9, M, Super M, Super MTA, MD, O4, O6, OD6, W4, W6, WD6, W9, WD9, W400, W450, 100, 130, 200, 230, 300, 330, 350, 400, 450, 600, 600D</p>	

B5011-002	Light Switch Resistor	\$15.99
 <p>Used on all Models with Cut Out Relay & Original Delco 4 Position Light Switch Replaces: Delco - #1838155, 1882994, 1878070 IHC/Farmall - #47891D Fits: IHC/Farmall - Cub Up to Serial #114502, A, Super A up To Serial #345198, B, BN, C up to serial #47125, H up to Serial #340,953, I4, I6, ID6 I9, ID9, M up to Serial #229,911, MD, O4, O6, OD6, W4, W6, WD6, W9, WD9</p>		

Momentary Switches

B5004-003	Momentary Push Switch	\$15.75
 <p>Manual Push Button Solenoid Switch with Rubber Protected Cap (2 Screw Terminals) Mounting Stem 5/8"-32 Thread Replaces: #367678R91, 393209R91, 271179R91, 373611R91 International - Fits: [Cub, 140, 240, 340, 404, 424, 444, 454, 460, 464, 504, 544, 560, 574, 606, 656, 660, 664, 666, 674, 686 (Horn Button)], [T4, T5 (Starter Switch)], TD5 (Starter Switch, SN: 3088 & up), [340, 350, 424, 444, 460, 504, 560, 606, 656, 660, 706, 2424, 2444, 2500, 2504, 2606, 2656, 2706, 3414, 3444, 3514, 3616, 3800, 3850 (Glow Plug Switch, Diesel)], [706, 756, 766, 806, 826, 856, 966, 1026, 1066, 1206, 1256, 1456, 1466, 1468, 1566, 1568, 2404, 2424, 2444, 2504, 2544, 2606, 2656, 2706, 2756, 2806, 2856, 3414, 3444, 3514, 3800, 3850, 4100, 4156, 4166, 4366, 4386, 4568, 4586, 21206, 21256 (Horn Button without tilt steering)], Crawler: 500 (Glow Plug Switch, Diesel), [Forklift: 5000, 7000 (Horn Button without tilt steering)], 7000 (Glow Plug Switch, Diesel), Cub Lo-Boy: Cub Lo-boy (Horn Button), [Hydro: Hydro 100, Hydro 70, Hydro 86 (Horn Button without tilt steering)];</p>		

B5004-007	Neutral Safety Switch	\$29.99
 <p>Manual Push Button Safety Switch used as a Neutral Safety Switch. 2 Spade Terminals. 5/8"-32 Thread. 2.575" Total Length. For use as neutral safety switch. International Replaces: #121629C1, 121629C2, 121629C3, 22-228, 22-642, 382728R91, 532682R1, 83954C91 Fits: 1026, 1066, 1086, 1206, 1256, 140 (SN: 45001 and up), 1456, 1466, 1468, 1486, 154, 1566, 1568, 1586, 185, 21026, 21206, 21256, 21456, 2400 (Hydro), 248 (SN: 816 and up), 2544, 258 (SN: 808 and up), 2656 (gas, diesel), 2706, 2756, 278 (SN: 801 and up), 2806, 2826, 2856, 3088, 3288, 3388, 3488, 3588, 3688, 3788, 385, 4100, 4156, 4166, 484 (SN: 6501 and up), 485 (SN: 7100 and up), 5088 (up to SN: 6243), 5288 (up to SN: 4210), 544, 5488 (up to SN: 2425), 584 (SN: 6953 and up), 585 (SN: 9312 and up), 6388, 656 (International / Farmall; gas / diesel, Hydro), 6588, 664, 666, 6788, [684, Hydro 84 (SN: 7253 and up)], 685 (SN: 10178 and up), 686, 706, 756, 766, 784 (SN: 7167 and up), 785 (SN: 12442 and up), 786, 806, 826, 856, 884 (SN: 6643 and up), 885 (SN: 2001 and up), 886, 966, 986, Cub (SN: 239827 and up), Hydro 100, Hydro 186, Hydro 70, Hydro 86, for use as a parking brake switch: 260A</p>		

Pressure Switches

B5012-001	Oil/Fuel Electric Pressure Fuel Sensor Switch	\$15.99
 <p>Designed to be screwed into the engine block and lead runs to a dummy light IHC/Farmall Replaces: #3106558R2, #3118643R1, #3129031R91, #376855R92, 392249R92, 529796R1, 530034R2, 65425C1, 91450C1 Fits: [1026, 1066, 1086, 1206, 1256, 1456, 1466, 1468, 1486, 154, 1566, 1568, 1586, 184, 185, 2400A, 2500A, 3088, 3288, 3388, 3414, 3444, 3588, 3688, 3788, 384, 385, 4100, 424, 444, 454, 464, 484, 485, 504, 544, 574, 584, 585, 6388, 656, 6588, 666, 674, 678,8, 684, 685, 706, 756, 766, 784, 785, 786, 806, 826, 856, 884, 885, 966, 986 (When Used as an Oil or Transmission Pressure Switch)], [Hydro: Hydro100, Hydro 70, Hydro 86 (When Used as an Oil or Transmission Pressure Switch)]</p>		

LIGHTS & LIGHT PARTS

Bullet Type Headlight & Rear Lamp		
B9016-017	6 Volt	\$49.99
B9016-053	12 Volt	\$54.99

 <p>IHC/Farmall Replaces: #45640DB, 61225DB Fits: A, AV, B, BN, C, Cub (to SN: 165,152), H, HV, I4, I6, I9, ID6, ID9, M, MD, MDV, MV, O4, O6, ODS6, OS4, OS6, Super A (to early 1953), Super AV (to early 1953), Super C (to SN: 159,454), Super H (to SN: 19,233), Super HV (to SN: 19,233), Super M (to SN: F28174, or Louisville built to SN: L504801), Super W4 (to early 1953), Super W6 (to SN: 3950), Super W9 (to SN: 1041), TD14, TD15, W4, W6, W9, WD6, WD9, WDR9, WR9 Crawler: 14A, 18A</p>		
--	--	--

PARTS FOR LIGHT ABOVE		
B9017-056	4 3/4" Lens with Guide Name	\$14.99
B9017-059	4 3/4" Clamp Ring (Red)	\$15.99
B9017-058	4 3/4" Gasket	\$3.99
B9017-004	4 3/4" Reflector	\$14.99
B9017-067	4 3/4" Light Terminal	\$6.00
B9017-013	6 Volt Bulb	\$3.00
	Pack of 10	\$25.50
B9017-015	12 Volt Bulb	\$3.00
	Pack of 10	\$25.50

Flat Back Head Lamp		
B9016-019	6 Volt	\$54.99
B9016-020	12 Volt	\$54.99
 <p>IHC/FARMALL Cub, Cub Lo-Boy, Super C, Super H, M, Super M, MD, Super MD, 100, 130, 140, 200, 230, 240, 300, 330, 340, 350, 400, 450 6 Volt Head & clear rear lamp Replaces: #357884R91, 357884R92, 357884R93, 357884R94 12 Volt Head & clear rear lamp Replaces: #357885R91, 357885R92, 357885R93</p>		

PARTS FOR FLAT BACK LIGHT ABOVE		
B9017-060	6-Volt Bulb Replaces: #358890R91, 358890R92	\$39.99
B9017-061	12-Volt Bulb Replaces: #358893R92	\$35.99
B9017-099	12-Volt LED Bulb, Flood Pattern Replaces: #358890R91, 358890R92, 358893R91, 358893R92	\$59.99
B9017-063	5" Clamp Ring	\$13.99
B9017-064	4 5/8" Gasket	\$6.99
B9017-065	Light Clamp	\$9.99

IHC/Farmall Sealed Beam Head Light		
B9016-030	6 Volt	\$49.99
B9016-031	12 Volt	\$88.95
	6 Volt Sealed Beam Head Light Replaces: #381181R91, 376849R91 Fits: Cub (Serviceable for following with 6 volt system, Serial #210001 & Up), 140 (Serviceable for Following with 6 Volt System, Up to Serial #26800) Cub Lo-Boy (Serviceable for Following with 6 Volt System, Serial #10001 & Up Replaces: #381181R91, 376849R91 12 Volt Sealed Beam Head Light 140 Serial #26801 & Up, 404, International Utility: 404, 504	

Sealed Beam Head Lamp Assembly for Flat Top Fenders		
B9016-022	12 Volt Low Beam	\$39.99
B9016-023	12 Volt High Beam	\$59.75
B9016-080	12 Volt LED Trapezoid	\$67.99
B9016-081	12 Volt LED Flood Light	\$67.99
	IHC/Farmall Replaces: #388946R91, 388945R91 Fits: 664, 666, 686, 706, 756, 766, 786, 806, 826, 856, 886, 966, 986, 1026, 1066, 1086, 1206, 1256, 1456, 1466, 1468, 1486, 1566, 1568, 1586, 3088, 3288, 3388, 3488, 3514, 3588, 3616, 3688, 3788, 4100, 4156, 4166, 4186, 4300, 4366, 4386, 4568, 4586, 4786, 5088, 5288, 5488, 6388, 6588, 6788, 7288, 7388, 7488, Farmall Rowcrop: 504, 544, 656 Hydro: Hydro 70, Hydro 86, Hydro 100, Hydro 186	

PARTS FOR LIGHT ABOVE		
B9017-031	Sealed Beam, 12 Volt High Beam	\$18.99
B9017-032	Sealed Beam, 12 Volt Low Beam	\$16.50
	4 1/2" diameter Double Contact Light Bulb 4.365" Outside Diameter	
	B9017-009	\$5.99
	Concave Light Mounting Washer/Retainer	

B9017-097	12-Volt LED Lamp, Trapezoid Beam Pattern	\$49.99
	IHC/Farmall Replaces: #131203C1, 131508C1, 134039H1, 144072H1, 21-521R1, 25-0133, 371461R91, 373662R1, 373662R91, 394770R2, 535850R1, 635959R91, 725-0222, 725-0588, 80627C1, 86594207, 87779219, 925-0222, 9410891 Fits: Cub, Cub Loboy, Hydro 6, Hydro 70, Hydro 84, Hydro 100, Hydro 186, TD7C, TD8C, TD8E, 140, 154, 184, 185, 260A, 354, 364, 384, 404, 420, 424, 444, 454, 460, 464, 484, 504, 544, 574, 606, 616, 656, 666, 674, 684, 686, 706, 756, 766, 786, 806, 826, 856, 886, 966, 986, 1026, 1066, 1086, 1206, 1256, 1456, 1466, 1468, 1486, 1566, 1568, 1586, 2400, 2500, 2544, 2606, 2656, 2706, 2756, 2806, 2826, 3088, 3288, 3388, 3400, 3488, 3588, 3600, 3688, 3788, 4100, 4156, 4166, 4186, 4366, 4386, 4568, 4586, 4786, 5088, 5288, 5488, 6388, 6588, 6788, 7288, 7488, 21026, 21206, 21256	

B9017-098	12-Volt LED Lamp, Flood Beam Pattern	\$49.99
	IHC/Farmall Replaces: #126470C1, 131203C1, 131348C1, 131508C1, 390756R91 GE: #4410, 4411 Fits: 544, 574, 584, 656, 666, 674, 684, 686, 706, 756, 766, 784, 786, 806, 826, 856, 884, 886, 966, 986, 1026, 1066, 1086, 1206, 1256, 1456, 1466, 1468, 1486, 1566, 1568, 1586, 2500, 3088, 3288, 3388, 3488, 3588, 3688, 3788, 4140, 4166, 4186, 4366, 4386, 4568, 4586, 4786, 5088, 5288, 5488, 6388, 6588, 6788, 7288, 7488, Hydro 70, Hydro 86, Hydro 100, Hydro 186 Industrial: 2500A, 2500B	

B9016-062	12V Headlight Assembly	\$49.99
	12 Volt, 5 3/4" Headlight. Stamped: TRACT-O-LITE on housing. IHC/Farmall Replaces: #377866R91 Fits: (w/ side-mounted lights): 706, 806 (with 12-volt system and hood-mounted lights- not grille mounted): 340, T340 (with hood mounted lights- not grille mounted): 404, 424, 444, 460, 504, 560, 606, 660, TD340	

PARTS FOR LIGHT ABOVE		
B9017-033	Sealed Beam, 12 Volt Bulb	\$14.75
	Double Contact High Beam 35 Watts with a 5.625" Outside Diameter Replaces bulb #4419	

See additional IHC/Farmall light parts on the following pages.

Bullet Type Work/ Tail Light with Switch		
B9016-021	6 Volt (B9016-083 for Black*)	\$79.99
B9016-018	12 Volt (B9016-084 for Black*)	\$79.99
	(*Black versions sold for lower prices) Combo/Red Dot Tail Lamp IHC/Farmall -(WILL NOT FIT 154, 184, 185)- Replaces: #373306R91 Fits: A, AV, B, BN, C, Cub, H, HV, I4, I6, I9, M, MD, MDV, MV, Super A, Super C, Super H, Super M, Super W4, Super W6, Super W9, T4, T5, TD5, W4, W9, WD9, WDR9, 100, 130, 140, 200, 230, 240, 300, 330, 340, 400, 450, 600, 650, Wheatland: 400, 450	

PARTS FOR LIGHT ABOVE		
B9017-056	4 3/4" Lens with Guide Name	\$14.99
B9017-059	4 3/4" Clamp Ring (Red)	\$15.99
B9017-058	4 3/4" Gasket	\$3.99
B9017-007	4 3/4" Reflector	\$21.99
B9017-067	4 3/4" Light Terminal	\$6.00
B9017-010	Light Switch Assembly	\$18.50
B9017-013	6 Volt Bulb 'teardrop'	\$3.00
	Pack of 10	\$25.50
B9017-015	12 Volt Bulb	\$3.00
	Pack of 10	\$25.50
B9017-037	6 Volt Miniature Bulb	\$1.25
B9017-039	12 Volt Miniature Bulb	\$1.25
B9017-066	Red Dot Jewel Lens Assembly	\$17.99
B9017-077	Rear Combo Light Switch with Knob (3 Screw Terminals)	\$18.50
B9017-095	Tail Light Gasket	\$2.99
B9017-031	Sealed Beam, 12 Volt High Bulb	\$18.99
B9017-032	Sealed Beam, 12 Volt Low Bulb	\$16.50

	4 1/2" diameter IHC/FARMALL 06, 56, & 66, Series with Deluxe Fender Lighting, Cub Lo-Boy 154
---	--

B9016-061	12 Volt Rear Combo Tail Light with Rubber Bezel (Hobbs Style)	\$74.99
	Restoration Quality 12 Volt Rear Combo Tail Light with Threaded Mounting Post and Single Connector on the Back. IHC/Farmall Replaces: #377102R91, 390047R91 Fits: 140 (SN: 26801 and up), 384, 464, 484, 544 Farmall, 574, 584, 656, 666, 674, 684, 686, 706, 756, 766, 784, 806, 826, 856, 884, 966, 1026, 1066, 1206, 1256, 1456, 1466, 1468, 1566, 1568, 4100, 4156, 4166, 4186, 21456, Hydro 100, Hydro 70, Hydro 84, Hydro 86 (Serviceable when replacing steel bezel light with rubber bezel light)-Cub (SN: 224401 and up), Cub Loboy (SN: 18701 and up, 154, 184, 185, 354, 404, 424, 444, 454, 504	

PARTS FOR LIGHT ABOVE		
B9017-069	Sealed Beam, 12 Volt Bulb	\$19.99
	Combination Rear Lamp w/ transparent red background using separate bulb Replaces: 166406A, 20-7000652, 71461R91, 371461R92, 377102R92, 676357R91	
B9017-115	LED Combination Rear Light Bulb, Red/White, Sealed Beam	\$49.99
	Flood Pattern, 18 Watts, 1200 Lumens, Can Be Switched to White or Red Light IHC/Farmall Replaces: 166406A, 20-7000652, 371461R91, 371461R92, 377102R92, 676357R91 Fits 4 1/2" O.D. Housing with Either Metal or Rubber Bezel	

B9016-054	Round Fender & Cab Mount Warning Light	\$19.99
	Restoration Quality 12 Volt Round Light with 2 x 4" Diameter Amber Lenses, Double Contact Bulb, 1/2" Diameter Stud, & 2.4" Thick at Widest Point. IHC/Farmall Replaces: #199954A1, 3123675R92, 394129R1, 531627R91, 67538C92 Fits (serviceable): 1026, 1066, 1086, 1206, 1256, 140, 1456, 1466, 1468, 1486, 154, 1566, 1568, 1586, 185, 21026, 21206, 21256, 21456, 2300A, 2400A, 2424, 2500A, 2544, 2656, 2706, 2756, 2806, 2856, 3088, 3288, 3514, 354, 3616, 364, 384, 385, 404, 4100, 4156, 4166, 4186, 424, 4366, 4386, 444, 454, 4568, 4586, 464, 484, 504, 544, 574, 584, 606, 656, 666, 674, 684, 686, 706, 756, 766, 784, 786, 806, 826, 856, 884, 886, 966, 986, Hydro: Hydro 100, Hydro 70, Hydro 86	

B9016-055	Rectangular Fender & Cab Mount Warning Light	\$32.99
	Restoration Quality 12 Volt Rectangular Light. One Red and One Amber Lens With Amber Side Marker 4.5" Wide & 1/2" Diameter Stud IHC/Farmall Replaces: 537328R1 Fits (Serviceable for custom cab & rectangular warning lights): 1066, 1466, 1468, 1566, 1568, 766, 966	

B9017-082	IHC/Farmall Cub Tail Light Bracket	\$22.99
	Quality Steel Mounting Bracket for Tail Lights on IHC/Farmall Cub Tractors IHC/Farmall Fits: Cub, Cub Lo-Boy Replaces: #352121R11, 352121R11GV, 352121R21 Note: Does Not Fit 154, 184, 185	

COMPLETE STARTERS

B9017-084	IHC/Farmall Forged Light Bracket (Left Hand)	\$12.99
	Quality Forged Steel Mounting Bracket for Lights on IHC/Farmall Tractors. 8 3/4" Overall Length. IHC/Farmall Replaces: #49394D Fits: A, [B, BN (Used as both LH and RH bracket)], Super A, 100, 130, 140	

B9017-085	IHC/Farmall Forged Light Bracket (Right Hand)	\$11.99
	Quality Forged Steel Mounting Bracket for Head & Tail Lights on IHC/Farmall Tractors. 3 3/4" Overall Length. IHC/Farmall Replaces: #49393D Fits: RH headlight bracket and tail light bracket: 100, 130, 140, A, Super A, tail light bracket only: B, BN	

B9017-086	IHC/Farmall Light Bracket, Curved	\$32.99
	*Call for Availability* Quality Forged Steel Mounting Bracket for Head & Tail Lights on IHC/Farmall Tractors. 4" Overall Length. IHC/Farmall Replaces: #353642R11 Fits: H, M, SUPER MVTA, SUPER MDV-TA, HV, MD, MDV, MTA, MV, SUPER H, SUPER HV, SUPER M, SUPER MD, SUPER MDV, SUPER MTA, SUPER MTA (DIESEL), SUPER MV	

4787N	6-Volt Starter with Switch	\$245.75
		New 6-Volt Replacement Starter with Switch IHC/Farmall Replaces Delco #1109603, 1109611, 1109613 Fits: Farmall Cub (up to serial #224,400) Note: Must be used with 6 volts only. Warranty will be void if used with 12 volts.

4033N	6-Volt Starter with Switch	\$162.50
		New 6-Volt Replacement Starter with Switch (#B5006-003) IHC/Farmall Replaces Delco #1107067, 1107093, 1108096. Fits: Super A, C, Super C, 100, 130, 140 (up to serial #26800), 200, 230. Note: Starter Switch Is Mounted On Commutator (Rear End Of Starter)

4132N	6-Volt Starter	\$168.61
		New 6-Volt Replacement Starter IHC/Farmall Replaces: Delco #1107427, 1107448, IHC #3104219A2, 997870R9, Case: #63608D. Fits: H, HV (Up to SN: 391357), I4, W4, O4, M, MV, Super M (Up to SN: F28174 & L504801), I6, T6, W6, Super W6 (Up to SN: 3950), & O6

FLASHERS

B9017-080	2-Terminal, 12-Volt Thermal Flasher	\$5.50
	12-Volt Thermal Flasher, Two Terminal IHC/Farmall Replaces: #552 Fits: 606 Gas or Diesel, 656 Gas Row Crop, 656 Diesel, 706 Gas with Generator, 706 Gas with Alternator, 706 Diesel (All), 806 Gas, 806 Gas with Alternator, 806 Diesel, 806 Diesel with Alternator, 1206 Diesel, 2706 Gas (All), 2806 Gas (All)	

STARTER PARTS

STARTER CE HOUSINGS

B7002-001	10MT Starter CE Housing	\$45.34
		Commutator End Housing for Delco 10MT Starters. Replaces: Delco - #1850147, 1850447, 1863470, 1864530, 1868714, 1871566, 1871659, 1873774, 1880870, 1881625, 1881627, 1881719, 1886098, 1907038, 1907138, 1908456, 1908459, 1908581, 1909456, 1909459, 1920409, 1920427, 1927463, 1935681, 1943578, 1946725, 813550, 815634, 815839, 818248, C1027, D4300 Fits OEM Units: Delco - #1107006, 1107010, 1107012, 1107016, 1107017, 1107031, 1107036, 1107044, 1107045, 1107046, 1107048, 1107051, 1107052, 1107060, 1107064, 1107067, 1107074, 1107082, 1107086, 1107090, 1107093, 1107127, 1107133, 1107134, 1107138, 1107149, 1107154, 1107156, 1107165, 1107169

B7002-002	Delco Cast Iron DE Housing	\$56.25
	Drive End Housing for Delco 10MT Starters without Integral Solenoids. Multi-Drilled for Universal Applications. Replaces: Delco - #1924299, 1924468, 1930639, 1938304 Fits: Delco Starters - #1107200, 1107358, 1107413, 1107424, 1107434, 1107437, 1107443, 1107454, 1107458, 1107682, 1107813, 1107815, 1107958, 1107967, 1108006, 1108009, 1108012, 1108038, 1108130, 1108142, 1108159, 1108165, 1109380	

B5004-004	Manual Push Button Starting Switch	\$14.99
	Wires Attach To Switch With Eyelets & Screws. (O.E.M.) IHC/Farmall Replaces: #366316R91, 366317R93 Fits: T4, T5, TD5 (up to SN #3087), 240, 300, 330, 340, 350, 400, 404, 424, 444, 450, 460, 504, 560, 606, 656, 660, 706, 806, 1206, 4100, 4156, 4166, 4186	

B5004-005	Manual Push Button Starting Switch	\$14.99
	Used for Starting or Ether, ECT (OEM) Wires Attach To Switch With Spade Terminals IHC/Farmall Replaces: #397940R93 Fits: 2400A, 2500A, 385, 395, 444, 454, 464, 484, 485, 495, 544, 574, 584, 585, 595, 664, 666, 674, 684, 686, 706, 756, 766, 784, 786, 806, 826, 856, 884, 886, 966, 986, 1026, 1066, 1086, 1206, 1256, 1456, 1466, 1468, 1486, 1566, 1568, 1586, 3088, 3288, 3388, 3488, 3588, 3688, 3788, 4100, 4156, 4166, 4186, 4366, 4386, 4568, 4586, 4786, 5088, 5288, 5488, 6388, 6588, 6788, 7288, 7488, Hydro: Hydro 100, Hydro 186, Hydro 70, Hydro 86	

B5011-006	Start Switch Lever	\$9.99
	Starter Rocker Switch Lever. Used with #B5006-003. Replaces: #1918322, 1919434 Fits: IHC/Farmall - A, AV, B, BN, C, Cub (sn 128799 and up), Cub Loboy ((WILL NOT FIT 154, 184, 185)), Super A, Super AV, Super C, Super H, Super HV, Super M, Super MTA, Super MV, Super W4, Super W6, Super WD6, T9, TD6 (using 1108925 starter), TD9, 100, 130, 140 (To Sn: 26800), 200, 230	

STARTER SWITCHES

(MECHANICAL)

B5006-001	Starter Switch (Long Shaft)	\$12.75
	6 or 12 Volt Panel Mounted Manual Push Start Switch Replaces: Delco - #192119, D900, 450C International Harvester (Farmall) - #131332-C2, 313331-C1, 313332-C1 Fits: IHC/Farmall - H, I4, I6, I9, M, O4, O6, W4, W6, W9	

B5006-003	Saddle Mount Lever Switch	\$11.75
	Lever or Rod operated, 6 or 12 Volt, Starter Mounted Manual Push Button Starter Switch Has Bracket for Rocker Lever Replaces: Delco - #1872403, 1872405, 1882323, 1918405, 1919576, 1919600, 1925781, 1918405, 1919578, 1919600, 1923480, 1925781, 1932131, 1940047, D903, D904, D905, D908, D909, IHC/Farmall - #593292C1, 70249D, Fits: IHC/Farmall - Cub, Cub Lo-Boy, A, AV, B BN, C, Super H, Super HV, Super M, Super MTA, O4, O6, O9, W4, W6, W9, WD6, WD9, WR9 (& Supers), 100, 130, 140, 200, 240, 300 (All with starter #1107093, 1107174, 1107491, 1108096 & Others)	



B5006-004	Starter Switch	\$11.75
	6 Or 12 Volt Starter Mounted Manual Push Button Starter Switch Fits: IHC/Farmall - MD, WD6, & Supers (with Starter #1108982)	

SOLENOIDS

B5007-001	6-Volt Solenoid	\$17.50
	3-Terminal with a Curved Mounting Bracket Fits: IHC/Farmall - 240, 300, 330, 340, 350, 400 With Starter #1107169, 1108097, 1108098	

B5007-002	12-Volt Solenoid	\$17.50
	3-Terminal with a Curved Mounting Bracket Fits: IHC/Farmall - 140 300, 400 LPG With Starter #1107238	
B5007-010	12 Volt Solenoid (Manual Push Button)	\$20.00
	12 Volt, 3 Terminal Solenoid With A Curved Mounting Bracket & Manual Push Button. Replaces: Autolite – SAE-4005, 15-60, SAW-4201 Fits: IHC/Farmall - 140 300, 400 LPG With Starter #1107238	
B5007-003	12 Volt Solenoid	\$17.50
	3 Terminal Solenoid With Flat Bracket Fits: IHC/Farmall – Cub (Serial #239,827 and Up), Cub Lo-Boy 154 Replaces: Ford - SWX118 Autolite/ Prestolite - 15-134, 15-136, 15-189, 15-250, SAE4001, SAE4005, SAE4005T, SAE4006, SAT4005, SAS4203, SAS4203M, SAS4205, SAW4204, SAW4207 IHC/Farmall – 121613C1	
B5007-017	12 Volt Lucas Solenoid	\$29.75
	12 Volt Rated Solenoid with 4 Terminals for Lucas M45G, M127, M418G Starters. 2 Hole Mount Stud & Removable Plunger. Replaces: Lucas - 76755, 76763, 76786, 76796, 76800, 76803, 76804, 76815, 76816, 76820, 76821, 76823, 76824, 76826, 76827, 76837, 76850, 76852, 76855, 76871, 76885, 76891, 76892, 76894, 76895, 76896, 76897, 76899, 76902, 76908, 76940, 76961, 76982, 76983, 77034, 77035, 77058, 77157, 77160, TOB109, TOB113, TOB121, TOB128, TOB134, TOB162, TPB107 Fits: IHC – 434, 444, & Other Various Models	
B5007-004	12 Volt Solenoid	\$23.75
	Has a Curved Bracket & 4 Terminals (Used with 30 & 35 MT Delco Starters) Fits: IHC/Farmall - Late 350, 450LP, 400, 450 Diesel, W400, W450, & The Following Diesels, 454, 464, 484 , 544, 560, 574, 660, 684, 706, 756, 806, 826, 856, 966 Standard, 1206, 1256, 1456 Delco : #1119890, 1119912, 1119885, 1119877, 1119935, 1119882, 1119906, D953, D985, 1119833, 1119883, 1115537, 1119978, 1115582, 1119778, 1115508, 1115529, 1115540, 1115501 IHC/Farmall - #65479C2, 585618C91	
B5007-032	12-Volt Delco Solenoid	\$27.50
	12 Volt Rated Solenoid for Delco Starters with 4 Terminals. Face-Mounted. Additional Mounting Parts Included. Fits: IHC/Farmall – 560 (Gas only)	

STARTER BRUSH SETS & STARTER BEARINGS

4787RK	IHC/Farmall Cub 6 Volt Starter Repair Kit	\$11.75
	Fits 6 Volt Delco Starter #1109603, 1109611, 1109613 Consists of 2 Bushings & 4 Brushes	
4214RK	IHC/Farmall Cub 12 Volt Starter Repair Kit	\$14.75
	Fits 12 Volt Delco Starter #1107021, 1107327, 1109352 Consists of 2 Bushings & 4 Brushes	
4033RK	IHC/Farmall 6 Volt Starter Repair Kit	\$11.75
	Fits: IHC/Farmall - A, B, C, & Supers, 100, 130, 140, 200, 230, 240 (with 6 Volt Delco Starter #1107067, & 1107092) Consists of 2 Bushings & 4 Brushes	
4132RK	IHC/Farmall 6 Volt Starter Repair Kit	\$11.75
	Fits: IHC/FARMALL - H, Super H (Up to Serial #19,233), M (with 6 Volt Delco Starter #1107427, 1107448) Consists of 2 Bushings & 4 Brushes	
4406RK	IHC/Farmall 6 Volt Starter Repair Kit	\$11.75
	Fits: IHC/FARMALL - Super H (Serial #19,234 & Up with 6 Volt Delco Starter #1108012) Consists of 2 Bushings & 4 Brushes	
4075RK	IHC/Farmall 6 Volt Starter Repair Kit	\$11.75
	Fits: IHC/FARMALL - SMTA (with 6 Volt Delco Starter #1108112) Consists of 2 Bushings & 4 Brushes	

3709RK	IHC/Farmall 12 Volt Starter Repair Kit	\$13.75
		Fits: IHC/FARMALL - 706D (D-282 Diesel 1963-1967, with 12 Volt Delco Starter #1113176) Consists of 3 Bushings & 4 Brushes

AUXILIARY PLUG & SOCKET

B9032-001	2 Pole Auxiliary Plug	\$23.75
		Fits: IHC/Farmall - 766, 866, 966, 1066, 1466, 1468, 1566

B9032-002	2 Pole Auxiliary Connector	\$19.75
		(Used With B9032-001) Fits: Cockshutt - Various Models

CIGARETTE LIGHTERS

B9030-001	6 Volt Cigarette Lighter	\$29.99
		With Anodized Aluminum Knob Engraved with the word Lighter International - Replaces: 363420R91, 367903R91 Fits: T340 (with 6 Volt systems, gas, up to SN 5395), 330 (with 6 Volt systems), 340 (with 6 Volt systems, gas), International Utility: 300 (with 6 Volt systems), Farmall Row crop: 300 (with 6 Volt systems), 350 (with 6 Volt systems, gas, up to SN 13242), International Utility: 350 (with 6 Volt systems, gas, up to SN 14600), Wheatland: 400 (with 6 Volt systems, gas), Farmall Row crop: 400 (with 6 Volt systems, gas), Wheatland: 450 (with 6 Volt systems, gas, up to SN 1350), Farmall Row crop: 450 (with 6 Volt systems, gas, up to SN 11083), Crawler: T6 (with 6 Volt systems (61 series))

B9030-002	12 Volt Cigarette Lighter	\$29.99
		With Anodized Aluminum Knob Engraved with the word Lighter International Replaces: 367904R91, 362000R91 Fits: TD14 (142 Series), TD15 (150 & 151 Series), TD18 (182 Series), TD20 (200 & 201 Series), TD25 (250 Series), TD340 (up to SN: 5395), TD6 (61 Series), TD9 (91 & 92 Series), 300, 330, 340, 350, 400, 450, 460, 560, 600, 650, 660, Wheatland: 400, 450





B9030-003	12 Volt Cigarette Lighter	\$27.99
		The knob is black plastic with the word 'lighter' in white printing. International Replaces: 378338R91, 378339R91, 378781R91, 382671R91, 382672R91, 393699R91, 1250545C1, 1265632C91 Fits: 154, 185, 404, 424, 444, 454, 464, 504, 544, 574, 606, 656, 664, 666, 674, 686, 706, 756, 786, 806, 826, 856, 886, 966, 986, 1026, 1066, 1086, 1206, 1256, 1456, 1466, 1468, 1486, 1566, 1568, 1586, 2400A, 2500A, 3088, 3288, 3388, 3414, 3444, 3488, 3500A, 3514, 3588, 3600A, 3616, 3688, 3788, 3800, 3850, 4100, 4156, 4166, 4186, 4366, 4386, 4568, 4586, 5088, 5288, 5488, 6388, 6588, 6788, 7288, 7488, Hydro: Hydro 100, Hydro 186, Hydro 70, Hydro 84, Hydro 86 Industrial: T340, TD340 (Serial #5396 and up)]

CARBURETOR REBUILD KITS

B9022-014	IHC Carburetor Rebuild Kit	\$46.75
		IHC/Farmall Tractors Model Cub Fits Carburetor: I.H.C. (Farmall) Carburetor: Fits carburetors with 'IH' emblem on float bowl.: #251234R91, 251234R92, 251234R93, 251234R94, 364579R91, 63349C9, 63349C91

B9022-008	Zenith Carburetor Rebuild Kit	\$26.95
		IHC/Farmall Tractors Model A, AB, AV, B, BN, C, SUPERS, C60, 100, 200, 130, 130HC, 154 LO-BOY, 185-LO-BOY, 230, 240, 330, 340, Balers Model 15, 22, 50 Fits Carburetor: Zenith Carburetor: #9167-A, 9748, 9749, 9750, 9752, 10386, 10386A, 10386C, 10441, 10441A, 10498, 10514, 10522, 10522A, 10652, 11115, 11115A, 11115D, 11338, 11339, 11339A, 11340, 11340A, 11704, 11704A, 11704B, 12115, 12122, 12123, 12225, 12285, 12342, 12475, 12476, 12522, 12544, 12566, 12612, 12613, 12632, 13056, 13794, 13871, 14544, S847 IHC/Farmall Carburetor: #40-02A-1, 48616-DC, 52499-DA, 52499-DB, 54214-DB, 68779-D, 70949-C91, 71523-C91, 85500-001, 251182-R92, 352046-R93, 352372-R92, 352376-R92, 352377-R92, 355485-R91, 352592-R91, 356901-R91, 357156-R91, 362384-R91, 366306-R91, 366462-R91, 366463-R92, 367700-R91, 367822-R91, 372096-R91, 375560-R91, 392425-R91

B9022-023	Marvel-Schebler Carburetor Rebuild Kit	\$24.50
		
<p><u>IHC/Farmall</u> Tractors Model 100, 130, 140, 200, 230, 240, 2404, 2444, 2504, 330, 340, 404, 424, 444, 504 (Early), 500, T340, A, A1, AV, B, BN, C, Super A, Super AV, Super AV1, Super C, T-340, TC-5, TS-5 Fits Carburetor:</p>		
<p>Marvel-Schebler Carburetor: #1004SL, TSX101, TSX102, TSX103, TSX112, TSX113, TSX114, TSX119, TSX120, TSX126, TSX128, TSX13, TSX132, TSX132A, TSX133, TSX134, TSX136, TSX137, TSX138, TSX140, TSX141, TSX142, TSX144, TSX146, TSX147, TSX148, TSX150, TSX151, TSX154, TSX155, TSX156, TSX157, TSX159, TSX161, TSX167, TSX171, TSX173, TSX179, TSX180, TSX182, TSX183, TSX184, TSX186, TSX188, TSX189, TSX190, TSX191, TSX192, TSX193, TSX194, TSX197, TSX198, TSX202, TSX203, TSX206, TSX206-1, TSX211, TSX212, TSX225, TSX228, TSX231, TSX237, TSX239, TSX239-1, TSX240, TSX241A, TSX241B, TSX241C, TSX246, TSX248, TSX253, TSX254, TSX258, TSX260, TSX264, TSX266, TSX267, TSX269, TSX272, TSX274, TSX278, TSX28, TSX280, TSX286, TSX287, TSX288, TSX289, TSX29, TSX290, TSX297, TSX30, TSX301, TSX305, TSX306, TSX308, TSX309, TSX312, TSX314, TSX315, TSX319, TSX322, TSX323, TSX326, TSX328, TSX33, TSX330, TSX331, TSX332, TSX333, TSX334, TSX335, TSX338, TSX339, TSX34, TSX341, TSX346, TSX347, TSX348, TSX35, TSX351, TSX352, TSX356, TSX357, TSX358, TSX359, TSX36, TSX361, TSX361-A, TSX363, TSX366, TSX367, TSX368, TSX37, TSX370, TSX370-1, TSX377, TSX38, TSX380, TSX388, TSX389, TSX39, TSX391, TSX398, TSX400, TSX403, TSX405, TSX406, TSX407, TSX409, TSX418, TSX419, TSX42, TSX420, TSX421, TSX422, TSX423, TSX428, TSX43, TSX44, TSX443, TSX447, TSX448, TSX45, TSX450, TSX452, TSX453, TSX455, TSX458, TSX459, TSX465, TSX470, TSX472, TSX474, TSX48, TSX480, TSX481, TSX484, TSX486, TSX49, TSX497, TSX500, TSX507, TSX510, TSX513, TSX514, TSX516, TSX518, TSX520, TSX525, TSX531, TSX532, TSX534, TSX539, TSX54, TSX541, TSX55, TSX551, TSX552, TSX556, TSX558, TSX560, TSX567, TSX569, TSX570, TSX573, TSX577, TSX58, TSX580, TSX589, TSX59, TSX593, TSX595, TSX597, TSX60, TSX603, TSX605, TSX606, TSX611, TSX614, TSX618, TSX626, TSX633, TSX635, TSX643, TSX646, TSX649, TSX649-1, TSX650, TSX653, TSX655, TSX656, TSX660, TSX663, TSX665, TSX668, TSX670, TSX671, TSX676, TSX680, TSX681, TSX683, TSX69, TSX690, TSX691, TSX692, TSX694, TSX696, TSX701, TSX706, TSX709, TSX710, TSX714, TSX730, TSX736, TSX74, TSX742, TSX744, TSX748, TSX753, TSX76, TSX762, TSX765, TSX767, TSX770, TSX771, TSX776, TSX776-1, TSX78, TSX781, TSX787, TSX79, TSX793, TSX796, TSX80, TSX802, TSX803, TSX804, TSX809, TSX812, TSX815, TSX820, TSX826, TSX827, TSX83, TSX830, TSX841, TSX844, TSX85, TSX851, TSX855, TSX857, TSX860, TSX862, TSX864, TSX865, TSX866, TSX879, TSX88, TSX882, TSX89, TSX896, TSX896SL, TSX90, TSX901, TSX91, TSX912, TSX913, TSX914, TSX919, TSX926, TSX930, TSX931, TSX936, TSX936SL, TSX937, TSX937SL, TSX94, TSX948, TSX949, TSX95, TSX954, TSX957, TSX957SL, TSX95A, TSX96, TSX971, TSX976, TSX978, TSX979, TSX979-1, TSX98, TSX983, TSX986, TSX987, TSX99, TSX990, TSX991, TSX991-1, TSX996, TSXU828, TSXU829, TSXU830, TSXU831, TSXU832, TSXU833, TSXU834, 1003 IHC/Farmall Carburetor: #352047R91, 372983R91, 372984R91, 372985R91, 372985R92, 381945R93, 389683R94, 397341R91, 404120R91, 404140R91, 69401D, 69402D, 69403D, 69404D ...</p>		

B9022-018	Carter Carburetor Rebuild Kit	\$19.25
		
<p><u>IHC/Farmall</u> Tractors Model AV, Super A, C, Super C, 100, 130, 200, 230, 240 Fits Carburetor: Carter Carburetor: #UT733S, UT734S, UT925SA, UT2222S w/Cast Iron Throttle Body</p>		
B9022-024	Carter Carburetor Rebuild Kit	\$44.99
		
<p><u>IHC/Farmall</u> Tractors Model C, Super A, Super AV, Super C, 100, 130, 140, 200, 230 Replaces: #373957R91, 373959R91, 373961R91, 373962R91, 76769R1 Fits Carburetor: Carter Carburetor: #0-653, 0-834, 0-839, 0-923S, 0-985, 0-1145, 0-1146, 0-1177, 0-1178, 0-1396, 0-1397, UT652, UT733S, UT734S, UT771A, UT795S, UT923S, UT925A, UT925S, UT997S, UT2222S, UT2223S, UT2402S, UT2418S, UT2257S, UT2612S, UT2701S, UT2709S Note: Many Carter carburetors are missing the tag and cannot be identified. This kit has all the bowl gasket variations along with both style needles and seats fitting <i>all</i> Carter carburetors.</p>		
B9022-009	Zenith Carburetor Rebuild Kit	\$27.99
		
<p><u>IHC/Farmall</u> Tractors Model 141 Fits Carburetor: Zenith Carburetor #11644, 11978, 14644 IHC/Farmall Carburetor: #274648</p>		
B9022-026	IHC Carburetor Rebuild Kit	\$25.50
		
<p><u>IHC/Farmall</u> Tractors Model H, HV, O4, W4 Fits IHC/Farmall Carburetor: #45108D, 45108DA, 45108DB, 45108DC, 45108DD, 45108DE, 50981D, 50981DB, 50981DC, 50981DD, 45108, 50981, Casting number: #6212DB, 6213DB</p>		
B9022-027	IHC Carburetor Rebuild Kit	\$27.25
		
<p><u>IHC/Farmall</u> Tractors Model [BM, M, MTA, MV, O6, W6 (with throttle body 8557D)], I9, Super H, Super M, Super MTA, Super MV, Super MVTA, Super W6, [W400, W450, 300, 350, 400, 450, 600, 650 (Must reuse old idle adjustment screw)], W6TA, W9, WR9, WR9S Replaces: #356948R92, 356948R93, 358065R91, 358065R93, 361525R92, 361525R93, 50983D, 50983DB, 50983DC, 50983DD, 52814D, 52814DB, 52815D, 52815DB, 52815DC, 58814DC, 60329D, 60329DA, 60329DB, 60329DC, 8867D, throttle body: 8867DX, 8557D Fits: IHC/Farmall Carburetor: #356948R91, 356948R92, 357231R92, 358065R91, 358554R91, 361525R91, 361525R92, 362173R91, 362173R92, 52814D, 52815D, 60329DA, with throttle body 8557DX or 8867D: 47387DB, 50983DB</p>		

B9022-005	Marvel-Schebler Carburetor Rebuild Kit	\$23.99
------------------	---	----------------



IHC/Farmall Tractors Model H, HV, M, MV, 6, W-9, WD-9, WR-9, WDR-9 & SUPERS, 300, 350, 400, 450
 Fits **Marvel-Schebler Carburetor:**
 TSX1001, TSX1002, TSX181, TSX221, TSX245, TSX296, TSX332, TSX360, TSX374, TSX397, TSX413, TSX414,

TSX436, TSX464, TSX466, TSX475, TSX492, TSX505, TSX506, TSX506A, TSX526, TSX528, TSX530, TSX561, TSX562, TSX563, TSX575, TSX582, TSX592, TSX596, TSX602, TSX605, TSX606, TSX610, TSX615, TSX633, TSX639, TSX641, TSX645, TSX648, TSX662, TSX678, TSX688, TSX689, TSX695, TSX704, TSX711, TSX713, TSX719, TSX721, TSX725, TSX732, TSX737, TSX738, TSX755, TSX756, TSX757, TSX759, TSX768, TSX769, TSX772, TSX773, TSX775, TSX777, TSX784, TSX788, TSX791, TSX792, TSX797, TSX798, TSX799, TSX800, TSX801, TSX806, TSX808, TSX810, TSX811, TSX813, TSX814, TSX816, TSX819, TSX825, TSX836, TSX843, TSX849, TSX853, TSX854, TSX856, TSX857, TSX867, TSX869, TSX871, TSX877, TSX878, TSX881, TSX883, TSX884, TSX885, TSX886, TSX888, TSX889, TSX892, TSX892S, TSX893, TSX894, TSX895, TSX897, TSX898, TSX899, TSX900, TSX902, TSX903, TSX904, TSX904SL, TSX905, TSX905-1, TSX905SL, TSX906, TSX906SL, TSX907, TSX907SL, TSX908, TSX908SL, TSX911, TSX917, TSX920, TSX920SL, TSX921SL, TSX922, TSX922SL, TSX923, TSX923SL, TSX925, TSX927, TSX928, TSX932, TSX932SL, TSX933, TSX934, TSX934SL, TSX938, TSX938SL, TSX939, TSX940, TSX940SL, TSX941, TSX941SL, TSX942, TSX943, TSX944SL, TSX945SL, TSX946, TSX947SL, TSX949, TSX950, TSX952, TSX952SL, TSX955, TSX959, TSX959SL, TSX961, TSX961SL, TSX962, TSX962SL, TSX964SL, TSX965SL, TSX966, TSX967SL, TSX968SL, TSX97, TSX972, TSX973, TSX974, TSX974SL, TSX975, TSX975SL, TSX977, TSX980, TSX980SL, TSX984SL, TSX985, TSX985SL, TSX988, TSX989, TSX993, TSX994, TSX997, TSX998, TSX999, TSXU1006, TSXU1007, TSXU835, TSXU836, TSXU840, TSXU904, TSXU904SL, TSXU905, TSXU905-1, TSXU944SL, TSXU963, TSXU9631, TSXU995

Replaces:

IHC/Farmall - #381945R93, 381945R93, 396966R91, 396966R91, 398069R91, 398069R92, 404731R91, 405873R91, 405873R93, 405879C93, 67235C91, 67235C91, 67238C91, 67238C91, 686680-C91, 686681-C91

B9022-011	Zenith Carburetor Rebuild Kit	\$24.99
------------------	--------------------------------------	----------------



IHC/Farmall Tractors Model 540
 Engine Type-C-153, C-200, C-291, WC-175
 Fits Carburetor:
Zenith Carburetor #12685, 12758, 12991, 12992, 12994, 13109, 13384, 13406, 13465, 13716, 14991, 14992

IHC/Farmall Carburetor #65486C92, 377234R94, 380490R92, 405030R91, 405530R91, 534475R91

B9022-022	IHC Carburetor Rebuild Kit	\$36.75
------------------	-----------------------------------	----------------



IHC/Farmall Tractor Model 560, 656, 660, 706, 756, 766, 806, 826, 856, 2656, 2706, 2756, 2806, 2826, 2856

Fits Carburetor:
IHC/Farmall Carburetor
 #378196R91, 378196R92, 378196R93, 379813R91, 379813R92, 379813R93,

381420R91, 381420R92, 381420R93, 381420R96, 388296R91, 388296R92, 388296R93, 388297R91, 388297R92, 388297R93, 388424R91, 388424R92, 388424R93, 388424R94, 388424R96, 388425R91, 388425R92, 388425R93, 388425R94, 388425R96, 396197R91, 396197R92, 396197R93, 396197R94, 396198R91, 396198R92, 396198R93, 396198R94, 533621R91, 533621R92, 533621R93, 533621R94, 533622R91, 533622R92, 533622R93, 533622R94, 539575R91, 539575R92, 539575R93, 539575R94

B9022-032	IHC Premium Carburetor Rebuild Kit	\$85.99
------------------	---	----------------



IHC/Farmall
 Tractor Model 560 (with 367259R91, 367259R92 carburetors)

Fits Carburetor:
IHC/Farmall Carburetor #367259R91, 367259R92

B9022-031	British Zenith Rebuild Kit	\$49.99
------------------	-----------------------------------	----------------



IHC/Farmall
 Includes: Needle and seat, gaskets and instructions (instruction sheet depicts parts that are not included in this kit; they are shown for reassembly purposes only).

Replaces: 3063945R91, 3106595R91
 Fits (with BC144 engines): B-275, 354,

444, 2300A, 2444, 3414, 3444, 7000 (Forklift)
 Fits Carburetor: **British Zenith** - VN, VNN, VNP, 3044193R92, C1751, C1759, 3106595R91, 3063945R91

CARBURETOR FLOATS

B9023-010	IHC Carburetor Float	\$29.50
------------------	-----------------------------	----------------



IHC/Farmall Tractors Model F12, F14, I, O, O12, W12, W14

Replaces:
IHC/Farmall: 25945D
 1.760" O.D., 1.000" Wide

B9023-005	IHC Carburetor Float	\$19.99
------------------	-----------------------------	----------------



IHC/Farmall Tractors Model Cub (Early models), Cub Loboy (Early models), 154
 1.405" O.D., 0.760" Wide

Fits **IH Carburetors** - #251293R91, 251234R91, 251234R92, 251234R93, 251234R94, 352063R91, 355712R91,

364579R91, 63349C1

B9023-006	IHC Carburetor Float	\$17.75
	<p>IHC/Farmall Tractors Model H, HV, I4, O4, W4 Replaces: IHC/Farmall: #45114D</p>	

B9023-015	Zenith Carburetor Float	\$24.99
	<p>IHC/Farmall Tractors Model 444, 504, 544, 574, 666, 674, 686 (Industrial) 2444, 2504, 2544, 3514 Replaces: IHC/Farmall: 381027R1, B51359, Zenith: #C85-115, C85-115S Fits Carburetor: (various- see www.brillman.com)</p>	

B9023-001	IHC Carburetor Float	\$20.95
	<p>IHC/Farmall Tractors Model Super H, I, M, MV, O, T, 6, W-9, Super W9, WD6, WD-9, WR-9, WDR-9 & Supers, 300, 350, 400, 450, 460, 544, 560, 574, 600, 606, 650, 656, 660, 706, 756, 766, 806, 826, 856, 2500 Gas, 2606, 2706 Replaces: IHC/Farmall: #47398D</p>	

CARBURETOR ACCESSORIES

B9023-003	Marvel-Schebler Carburetor Float	\$12.75
	<p>IHC/Farmall Tractors Model A, Super A, B, Super B, C, Super C, T-340, TC-5, TS-5 100, 130, 140, 230, 240, 330, 340, 404, 424, 444, 500, 2444 Replaces Carburetor: Marvel-Schebler Carburetor: #TSX-156, TSX-157, TSX-171, TSX-198, TSX-319, TSX-333, TSX-347, TSX-348, TSX-730, TSX-744, TSX-748, TSX-827, TSX-926, TSX-930, TSX-948, TSX-949, TSXU-831, TSXU-832, TSXU-834 IHC/Farmall Carburetor: #69401-D, 69402-D, 69403-D, 69404-D, 352047-R91, 352048-R91, 352688-R91, 352689-R91, 372983-R91, 372984-R91, 372985-R91, 372985-R92, 397341-R91, 404120-R91, 404140-R91 Replaces: IHC/Farmall: #69919D</p>	

B9038-001	Carburetor Fuel Line Fitting with Strainer	\$19.99
	<p>For IHC carburetors. 1/4" Pipe to 5/16" Flare. IHC/Farmall Fits: F12, F14, H, HV, Super H, Super HV, I4, I6, I9, ID6, ID9, M, Super M, MD, Super MD, MDV, Super MDV, MTA, MV, Super MV, O4, O6, O12, O14, ODS6, OS4, OS6, TD6, W4, Super W4, W6, W6TA, W6TA (Diesel), W9, W12, W14, WD6, WD9, Super WD9, WR9, WRD9, Super WDR9, WR9S, 300, 350, 400, 400 (Wheatland), 450, 450 (Wheatland), 460, 560, 600, 606, 650, 656, 660, 686, 706, 756, 766, 806, 826, 856 Replaces: #29902DX IHC Carburetor Fits: #356948R92, 35865R91, 366066R91, 367258R92, 367259R92, 372723R92, 378196R94, 379812R91, 379813R92, 380956R91, 381984R91, 388297R92, 388424R92, 388425R96, 390082R92, 396197R93, 45108DB, 45108DC, 50981DA, 50981DB, 50983DB, 52714D, 52814DA, 52815D, 52815DA, 533622R91, 53873DF, 53873DH, 539575R91, 56543DE, 60329DA, F8</p>	

B9023-007	Zenith Carburetor Float	\$16.99
	<p>IHC/Farmall Tractors Model A, AB, AV, B, BN, C, SUPERS, C60, 100, 200, 130, 130HC, 154 LO-BOY, 185-LO-BOY, 230, 240, 330, 340 Replaces Carburetors: Zenith Carburetor: #9748, 9749, 9750, 9752, 10386, 10386A, 10386C, 10441, 10441A, 10514, 10522, 10522A, 10652, 11115, 11115A, 11115D, 11338, 11339, 11339A, 11340, 11340A, 11704, 11704A, 11704B, 12115, 12122, 12123, 12225, 12285, 12342, 12475, 12476, 12522, 12544, 12566, 12612, 12613, 12632, 13056, 13794, 13871, 14544 IHC/Farmall Carburetor #40-02A-1, 48616-DC, 54214-DB, 52499-DB, 70949-C91, 71523-C91, 85500-001, 251182-R92, 352046-R93, 352372-R92, 352376-R92, 352377-R92, 355485-R91, 356901-R91, 357156-R91, 362384-R91, 366306-R91, 366462-R91, 366463-R92, 367700-R91, 367822-R91, 372096-R91, 375560-R91, 392425-R91 Replaces: IHC/Farmall: #53783D, Zenith: #C85-28</p>	

B9038-002	Carburetor Elbow Fuel Line Fitting with Strainer	\$29.95
	<p>Elbow Fuel Line Fitting with strainer for IHC carburetors. 1/8" Pipe to 5/16" Flare. IHC/Farmall Replaces: IHC/Farmall - #354827R91, 53796D, 69938D Fits: [A, Super A, B, C, Super C, Cub, Cub Loby, 100, 130, 140, 154, 184, 185, 200, 240, 330, 340, 404, 424, 444, 504, T340, T5 (with Listed Carter, Marvel Shebler, Zenith carburetors, using 5/16" O.D. fuel line)] Carburetors - #8928, 9167, 9722, 9749, 9750, 9751, 9752, 10386, 10441, 10498, 10514, 10522, 11115A, 11188, 11228, 11338, 11339, 11340, 11704, 11776, 11882, 12122, 12123, 12225, 12285, 12475, 12522, 12613, 12632, 12685, 12758, 12781, 13794, 14007, 14544 Marvel-Schebler - #67-528, C150-17</p>	

B9038-003	Carburetor Elbow Fuel Line Fitting with Strainer	\$7.99
	<p>Elbow Fuel Line Fitting with strainer for IHC carburetors. 1/8" Pipe to 1/4" Flare. Works with Carter UT Series and Various Marvel-Schebler Carburetors.</p> <p>International Replaces: #69938D Fits: A, B, C, SUPER C, AV, BN, SUPER A, 130, 140, 404, 424, 444, 504 (WHEN USING MARVEL-SCHEBLER CARBURETOR)</p>	

B9038-005	Right Angle Carburetor Fuel Line Fitting with Strainer	\$32.99
	<p>1/8" male threads, 3/4" long screen, 1/8" by 1/4" pipe compression</p> <p>IHC/Farmall Fits [with Carter, Marvel Schebler & Zenith carburetors, using 1/4" O.D. fuel line]: 100, 130, 140, 200, 230, 240, 330, 340, 404, 444, 504, 2444, 3514, A, B, C, Super A, Super C, T340, T4, T5 [with Zenith only, using 1/4" O.D. fuel line]: 154, 184, 185 Fits Carburetors: #1247S, 8928, 9167, 9722, 9749, 9750, 9751, 9752, 10386, 10441, 10498, 10514, 10522, 11115A, 11188, 11228, 11338, 11339, 11340, 11704, 11776, 11882, 12122, 12123, 12225, 12285, 12475, 12522, 12613, 12632, 12685, 12758, 13781, 13794, 14007, 14544</p>	

B9038-007	2" Sediment Bowl Gasket	\$2.19
	<p>2" Outer Diameter, Bowl to Body; Fits a 1.28" Tall Glass Bowl</p> <p>IHC/Farmall Replaces: 13193D, 360679R1 Fits (using/ 1.280" long glass bowl): A, B, BN, C, Cub, Cub LoBoy, Super A, Super A-1, Super AV, Super AV-1, Super C, 100, 130, 140, 154, 184, 185, 200, 230, 240, 300, 330, 404 (Gas Only, using/ 1.280" long glass bowl): 340, 350, 424, 444, 454, 460, 464, 504, 544, 574, 606, 656, 674, 2400A, 2404, 2424, 2444, 2500A, 2504, 2606, 2656 (Row crop Diesel with Auxiliary Fuel Tank Under Tractor): Hydro 100, 706, 756, 806, 826, 856, 1026, 1066, 1206, 1256, 1456, 1466, 1566</p>	

FUEL SEDIMENT BOWLS

B9036-001	Fuel Sediment Bowl	\$27.99
	<p>Has a 3/8" Pipe Inlet and a 1/8" Pipe Outlet. Bowl is 1.280" Long. Shallow Bowl has 90° Outlet Only.</p> <p>IHC/Farmall Replaces: #354222R91, 355142R91, 369988R91, 38465D, 51066DC, 61782C91 Fits: [A, B, BN, C, Cub, Cub Loboy, Super A, Super A-1, Super AV, Super AV-1, Super C, 100, 130, 140, 154, 184, 185, 200, 230, 240, 2400A, 2404, 2500A, 2504, 2606, 404, 454, 464, 504, 544, 574, 606, 674 (Gas Only)], TD15 (used for the starting tank), Industrial: 2656 (Gas Only), [International Utility: 300, 330, 340, 350 (Gas Only)], [International: 460, 656 (Gas Only)]</p>	

B9036-004	Sediment Bowl Assembly	\$34.99
	<p>Has a 2.315" long bowl with a 3/8" NPT fuel inlet and a 5/16" compression outlet. Includes one fuel line fitting for a 5/16" line.</p> <p>IHC/Farmall Replaces: #358245R91, 362494R91, 370832R91, 51066DBX, 64049DX Fits [Gas Only]: H, I4, I6, I9, M, MTA, MV, O4, O6, OS4, OS6, Super H, Super HV, Super M, Super MTA, Super MV, Super MVTA, Super W4, Super W6, Super W6TA, Super W9, W4, W6, W9, WR9S, 400, 450, 460, 560, 660, 706, 756, 766, 806, 826, 856, 2706, 2756, 2826 Industrials: T6, T9, 2856, 3400A, 3414, 3500A, 3514, 3600A, 3616, 7000 Rowcrops: 300, 340, 350, 656</p>	

B9036-005	Farmall Fuel Sediment Bowl	\$35.95
	<p>Has a 1.280" long bowl with a 5/16" tube outlet and a 3/8" pipe inlet. Includes one fuel line fitting for a 5/16" line.</p> <p>IHC/Farmall Replaces: #38465D, 51066DC, 61782C91, 354222R91, 355142R91, 369988R91 Fits [Gas Only]: 100, 130, 140, 154, 184, 185, 200, 230, 240, 300, 330, 340, 350, 404, 454, 460, 464, 504, 544, 574, 606, 656, 674, 2606, 2656, A, B, BN, C, Cub, Cub Loboy, Super A, Super A-1, Super AV, Super AV-1, Super C Industrials [Gas Only]: 2400A, 2404, 2500A, 2504, 4000, TD15 (used for the starting tank)</p>	

FUEL SYSTEM ACCESSORIES

B9038-017	Farmall Fuel Cap	\$32.99
	<p>2 1/2" Tall, 2.144" Tang to Tang Length, 0.400" Tang Width 1.840" Inside Center Diameter, 2 7/8" Outside Diameter</p> <p>IHC/Farmall Replaces: #224839C92, 23995DC, 361910R1, 361910R91, 65024D Fits: IHC/Farmall- A, A-I, AV, B, BN, C, Cub, Cub Loboy, H, HV, Hydro 100, Hydro 186, Hydro 70, Hydro 86, I4, I6, I9, ID6, ID9, M, MD, MDV, MTA, MV O4, O6, ODS6, OS4, OS6, Super A, Super A-1, Super AV, Super AV-1, Super C, Super H, Super HV, Super M, Super MD, Super MDV, Super MDV-TA, Super MTA, Super MV, Super MVTA, Super W4, Super W6, Super W6TA, Super W9, Super WD6, Super WD9, Super 2544, T340, T5, T6, TD6, TD15, TD18, TD18A, TD20, W4, W6, W6TA, W9, W400, W450, WD6, WD9, WDR9, WR9, WR9S, 100, 130, 140, 154, 184, 185, 200, 230, 240, 300, 330, 340, 350, 400, 404, 424, 444, 450, 460, 504, 544, 560, 600, 606, 650, 656, 660, 664, 666, 686, 706, 756, 766, 786, 806, 826, 856, 886, 966, 986, 1026, 1066, 1086, 1206, 1256, 1456, 1466, 1468, 1486, 1566, 1568, 1586, 2404, 2424, 2504, 2606, 2656, 2706, 2756, 2806, 2826, 2856, 3088 (with ROPS only), 3414, 3514, 3616, 4100, 4156, 4166, 4186, 4366, 4568</p>	

RADIATOR ACCESSORIES

B9041-001	Farmall Radiator Cap w/ Wing	\$17.99
	<p>Replaces: #67448DA, 67448DB, 67448DC, 67448DD Fits: Super A, C (except certain radiators), Super C (except certain radiators), H (Serial #115030 and up), Super H, M, MD, Super M, Super MD, Super MTA, O6, ODS6, Super W4, W4, Super W6, W6, Super W9, W9, WD6, Super WDR9, WD9 (except certain radiators)</p>	

IHC GAS ENGINES

SPARK PLUG WIRE SETS

Our Spark Plug Wire Sets Come Fully Assembled with the Proper Type Wire & Terminals.

They are Custom Tailored to Look & Fit Like Original Factory Equipment.

Varieties include:

Cotton Braid Wire: Copper Core with a Cotton Jacket.

PVC Wire: Copper Core with a Rubber Jacket.

EPDM Wire (E): Hi Performance Premium Conductor with a Tinned Copper Core, EPDM Silicone Insulation, and a Rubber Jacket.



McCormick Deering 300 POWER UNIT

4 Cyl. Tailored Spark Plug Wire Set

B1025-001	Original Type Cotton Braid Wire	\$23.25
B1025-001E	EPDM Wire	\$25.50

McCormick Deering M, 1.5 HP

1 Cyl. Tailored Spark Plug Wire Set

B1025-005	Original Type PVC Wire	\$7.25
B1025-005E	EPDM Wire	\$9.00

McCormick Deering M, 3 HP

1 Cyl. Tailored Spark Plug Wire Set

B1025-002	Original Type PVC Wire	\$7.25
B1025-002E	EPDM Wire	\$9.00

McCormick Deering LA

1 Cyl. Tailored Spark Plug Wire Set

B1025-003	Original Type PVC Wire	\$7.25
B1025-003E	EPDM Wire	\$9.00

McCormick Deering LB

1 Cyl. Tailored Spark Plug Wire Set

B1025-004	Original Type PVC Wire	\$7.25
B1025-004E	EPDM Wire	\$9.00

TUNE UP PARTS

With IHC MAGNETO #H-1

	B4011-009	\$5.50
	Point Replaces: #353171R91	
	B4012-005	\$9.25
	Condenser Replaces: #373892R92, 21409DB, 47546D	
	B4015-005	\$44.75
	Coil Replaces: #21401D, 21401DAX, 57926DX, 47439D Premium Quality, Made in the USA	
	B4013-022	\$29.99
	Coil Cover Replaces: #47449DAY	
	B4016-017	\$7.50
	Gasket Set Replaces: #359966R1, 47408D, 47453D, 48472DA, 49419D, 55780DD, 55780DE, E4226	
	B4016-018	\$3.75
	Leather Seal Can be used with B4016-017 above	

CYLINDER SLEEVE SEALS

Call for Availability	
IHC Model M, 1 ½ H.P. (Specify Igniter or Spark Plug)	\$3.50
IHC Model M, 3 H.P.	\$4.50
IHC Model M, 6 H.P.	\$4.50

IHC CUB CADET LAWN & GARDEN TRACTORS

TABLE OF CONTENTS

Spark Plug Wire Sets	219
Battery Cables	219
Wire Harnesses	220
Magnetos	221
Tune Up Parts for Battery Ignition	221
Electronic Ignition Conversion Kits	222
Voltage Regulators	222
Generator Bearings & Brush Sets	222
Ignition Switches	222
Alternator Conversion Kits	223
Cigarette Lighters	223

SPARK PLUG WIRE SETS

Our Spark Plug Wire Sets Come Fully Assembled with the Proper Type Wire & Terminals.

They are Custom Tailored to Look & Fit Like Original Factory Equipment.

Varieties include:

Cotton Braid Wire: Copper Core with a Cotton Jacket.

PVC Wire: Copper Core with a Rubber Jacket.

EPDM Wire (E): Hi Performance Premium Conductor with a Tinned Copper Core, EPDM Silicone Insulation, and a Rubber Jacket.



IHC Cub Cadet Original, 70, & 100

with K161 or K241 Kohler Engine
1 Cyl. Tailored Spark Plug Wire Set

B1026-001	Original Type PVC Wire	\$6.25
B1026-001E	EPDM Wire	\$7.50

IHC Cub LoBoy 154, 184, 185

4 Cyl. Tailored Spark Plug Wire Set

B1026-002	Original Type PVC Wire	\$23.75
B1026-002E	EPDM Wire	\$26.00
B1026-002S	Suppression Wire	\$26.00

IHC Cub Cadet 682

with Kohler KT17 Spec 24193 Engine
2 Cyl. Tailored Spark Plug Wire Set

B1026-004	Original Type EPDM Wire	\$16.50
------------------	-------------------------	----------------

IHC Cub Cadet 982

with Onan B48G Engine
2 Cyl. Tailored Spark Plug Wire Set

B1026-005	Original Type EPDM Wire	\$16.50
------------------	-------------------------	----------------

BATTERY CABLES



Our Battery Cables are made from the Proper Gauge Copper, as either Black Cotton Braided Wire or PVC Wire (whichever is correct for the application), using Soldered & Heat Sealed Brass or Copper Terminals.

IHC Cub Cadet Original

B2026-001	Negative Battery Cable	\$15.00
B2026-002	Positive Battery Cable	\$17.00
B2026-011	Switch to Starter Cable (part of B3026-001)	\$19.75

IHC Cub Cadet 70 & 71

B2026-003	Negative Battery Cable	\$18.00
Replaces #384924R91		
B2026-002	Positive Battery Cable	\$17.00
Replaces #376287R92, 376287R93, 392966R92		

IHC Cub Cadet 72 & 73

B2026-002	Positive Battery Cable	\$17.00
Replaces #376287R92, 376287R93, 392966R92		

IHC Cub Cadet 100

B2026-003	Negative Battery Cable	\$18.00
Replaces #384924R91		
B2026-002	Positive Battery Cable	\$17.00
Replaces #376287R92, 376287R93, 392966R92		

IHC Cub Cadet 123

B2026-003	Negative Battery Cable	\$18.00
Replaces #384924R91		
B2026-014	Positive Battery Cable	\$12.25
Replaces #392966R91		
B2026-015	Switch to Starter Cable (part of B3026-010)	\$15.00

IHC Cub Cadet 104, 105, 106, 107, 124, 125, 126, 127, 147

B2026-002	Positive Battery Cable	\$17.00
Replaces #376287R92, 376287R93, 392966R92		

IHC Cub Lo-Boy 154

B2000-006	Negative Battery Strap	\$13.50
B2026-007	Positive Battery Cable	\$17.75
B2026-008	Switch to Starter Cable	\$17.50

IHC Cub Cadet 682

B2026-009	Negative Battery Cable	\$16.00
Replaces #725-0978, 925-0978		
B2026-010	Positive Battery Cable	\$16.00
Replaces #725-3078, 925-3078		



WIRING HARNESSSES

Our Wire Harnesses are made with our **premium cotton braid and/or PVC wire**.

They have the **correct gauge, color, wire, & fuse holders** (if needed).

All terminals are **soldered according to the original**.

(Harnesses do not include Battery Cables & Spark Plug Wires; however, we can supply these as separate products.)

NO HIDDEN COSTS, NOTHING EXTRA TO BUY!

IHC Original Cub Cadet

B3026-001	Wire Harness	Main Harness with Positive Battery Cable & Switch to Starter Cable, Replaces #379595R91 or #376285R91	\$96.75
------------------	---------------------	--	----------------

IHC Cub Cadet 70

B3026-002	Main Wire Harness	Main Harness with Manual Push Button Start Replaces #384923R91	\$88.50
B3026-010	Main Wire Harness	With Solenoid (Key) Start Replaces #404363R2	\$102.50

IHC Cub Cadet 71

B3026-010	Main Wire Harness	With Solenoid (Key) Start Replaces #404363R2	\$102.50
------------------	--------------------------	---	-----------------

IHC Cub Cadet 72

B3026-003	Main Wire Harness	Main Harness Replaces #59321C91 or #404379R4	\$122.25
------------------	--------------------------	--	-----------------

IHC Cub Cadet 73

B3026-003	Main Wire Harness	Main Harness Replaces #59321C91 or #404379R4	\$122.25
------------------	--------------------------	--	-----------------

IHC Cub Cadet 100

B3026-002	Main Wire Harness	Main Harness With Manual Push Button Start Replaces #384923R91	\$88.50
B3026-010	Main Wire Harness	With Solenoid (Key) Start Replaces #404363R2	\$102.50

IHC Cub Cadet 102

B3026-010	Main Wire Harness	With Solenoid (Key) Start Replaces #404363R2	\$102.50
------------------	--------------------------	---	-----------------

IHC Cub Cadet 104

B3026-003	Main Wire Harness	Main Harness Replaces #59321C91 or #404379R4	\$122.25
------------------	--------------------------	--	-----------------

IHC Cub Cadet 105

B3026-003	Main Wire Harness	Main Harness Replaces #59321C91 or #404379R4	\$122.25
------------------	--------------------------	--	-----------------

IHC Cub Cadet 106

B3026-003	Main Wire Harness	Main Harness Replaces #59321C91 or #404379R4	\$122.25
------------------	--------------------------	--	-----------------

IHC Cub Cadet 107

B3026-003	Main Wire Harness	Main Harness Replaces #59321C91 or #404379R4	\$122.25
------------------	--------------------------	--	-----------------

IHC Cub Cadet 122

B3026-010	Main Wire Harness	With Solenoid (Key) Start Replaces #404363R2	\$102.50
------------------	--------------------------	---	-----------------

IHC Cub Cadet 123 Hydro

B3026-010	Main Wire Harness	With Solenoid (Key) Start Replaces #404363R2	\$102.50
------------------	--------------------------	---	-----------------

IHC Cub Cadet 124

B3026-003	Main Wire Harness	Main Harness Replaces #59321C91 or #404379R4	\$122.25
------------------	--------------------------	--	-----------------

IHC Cub Cadet 125

B3026-003	Main Wire Harness	Main Harness Replaces #59321C91 or #404379R4	\$122.25
------------------	--------------------------	--	-----------------

IHC Cub Cadet 126

B3026-003	Main Wire Harness	Main Harness Replaces #59321C91 or #404379R4	\$122.25
------------------	--------------------------	--	-----------------

IHC Cub Cadet 127

B3026-003	Main Wire Harness	Main Harness Replaces #59321C91 or #404379R4	\$122.25
------------------	--------------------------	--	-----------------

IHC Cub Cadet 147

B3026-003	Main Wire Harness	Main Harness Replaces #59321C91 or #404379R4	\$122.25
------------------	--------------------------	--	-----------------

IHC Cub Lo-Boy 154

B3026-016	Complete Wire Harness	Original Design with Starter/ Generator	\$186.50
B3026-017	Dash & Engine Harness Only	Made with PVC Wire	\$106.00
B3026-018	Rear Harness Only	Made with PVC Wire	\$89.75

ORIGINAL MAGNETOS

Rebuilt

Our Rebuilt Magnetos are completely torn down, cleaned, & inspected. They will (at the minimum) have the following new parts: Points, Condenser, Coil, Coil Insulators, Lead-out Tower, & Outside Covers, plus any additional parts that are needed to make the unit look & perform like new.

They come with a 1-Year Limited Warranty.

Notes:

1. Unless otherwise specified, cost is exchange price.
2. A core charge (see below) will be charged to your credit card until we receive your good core.
3. A good core is considered a complete magneto with no cracks or weld repairs. Only good cores will be credited.

*Magnetos must be used with copper ignition wire.
Use of any other type will Void the Warranty.*

IHC/Farmall Rebuilt J4 Magneto

	J4MR	Exchange	\$345.00
		Outright	\$570.00
	IHC/Farmall: Cub & Cub Lo-Boy Core Charge: \$225.00		

TUNE UP PARTS FOR BATTERY IGNITION

(WITH DISTRIBUTOR)

IHC/Farmall 4 Cyl. Cub Lo-Boy, 154, 184
(with IHC distributors)

	B4100-007	\$12.75
	PCR Kit Includes: Points (#B4001-015), Condenser (#B4002-011), Rotor (#B4004-011) Replaces: Points - #353172R91 Condenser - #353903R91 Rotor - #353896R91	
	B4003-011	\$13.50
	Cap Replaces: #351693R91, 351693R92 Premium Quality, USA Made with Brass Contacts	
	B4004-011	\$4.75
	Rotor Replaces: #353896R91	

	B4007-003 Cap Clip 2 Used Replaces: #353894R1	\$14.99
	B4006-003 Dust Cover Replaces: #353900R11	\$13.99
	B4008-016 IH Breaker Plate Replaces: #352277R11	\$24.75
	B4008-020 IH Distributor Advance Spring Replaces: #353918R1	\$7.50
	B4005-003 Original Style IHC 6 Volt Coil Replaces: #353874R91, 396546R91	\$59.99
	B4005-004 Original Style IHC 12 Volt Coil Replaces: #353875R91, 395331R91	\$57.99
	B4008-023 Primary Screw & Insulator Kit Includes: Terminal Screw (B4008-003), Insulating Terminal Washer (B4008-004), & IH Distributor Insulator (B4008-013) Replaces: #120622, 121841, 251538R1, 353906R1, 353907R1 Fits: IH Distributor (#368051R1, 401107R1, 353898R11)	\$18.99

* For 12-Volt Ignition Coils & Accessories, see p.44

ELECTRONIC IGNITION CONVERSION KITS

Replaces Points & Condenser



**IHC/Farmall 4 Cyl. Cub, Lo-Boy
with Horizontal IHC Distributor**

B9600-046	12 Volt Negative Ground	\$149.95
B9600-046II	12 Volt Negative Ground with Upgraded Current Protection	\$205.95
B9600-046P12	12 Volt Positive Ground	\$165.45

VOLTAGE REGULATORS

Note: Due to modern battery design, voltage regulators can't be used to charge low or dead batteries. Doing so will destroy the voltage regulator and void the warranty.

12-Volt Delco Type Voltage Regulator		
B8002-017	Premium Quality, Made in the USA	\$99.75
B8002-018	Standard Quality	\$34.75



12 Volt, 4 Terminals, Flat Mounting
Bracket Regulator, Tractor Mounted
Terminals BAT, GEN, F, L
Replaces: **Delco** - #1118381, 1118779,
1118977, 1118987, 1118993, 1118997,
1118999, 1119576, D646
IHC/Farmall - #376122R91

Fits: **IHC/Cub Cadet** – Original, 70, 100

B8002-034	12-Volt Delco Type Voltage Regulator	\$113.75
------------------	---	-----------------

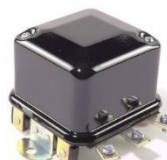

12 Volt, 4 Terminal, Flat Mounting
Bracket Regulator.
Tractor Mounted
Terminals BAT, GEN, F, GND
Replaces: **IHC** – #545130R92,
545130R93

Fits: **IHC/Cub Cadet** – 71, 72, 73, 86,
102, 104, 105, 106, 107, 108, 122, 123, 124, 125, 126, 127,
128, 147

Premium Quality/ Made in the USA

GENERATOR BEARINGS & BRUSH SETS

9199RK	12 Volt IHC/Farmall Cub Lo-Boy 154, 184 Generator Repair Kit	\$15.75
---------------	---	----------------



Consists of 2 Brushes & 2 Ball Bearings
With Generator Mounted Regulator
12 Volt, Fits Starter/ Generator
#1101698

IHC / Farmall

Fits: Farmall Cub Lo-Boy 154, 184

Ignition Switches

B5003-011	Ignition Key Switch	\$43.99
------------------	----------------------------	----------------



Includes 1 Key, 2 Nuts, and 1 Lockwasher.
Designed for 0.800" hole diameter.

International

Replaces: #60736C3, 60736C2, 60736C1

Fits: Cub Cadet: 70, 71, 72, 73, 86, 100,
102, 104, 105, 106, 107, 108, 109, 122, 123,
124, 125, 126, 127, 128, 129, 147, 149, 169

B5003-008	Ignition Key Switch	\$24.99
------------------	----------------------------	----------------



Includes 2 Keys, 2 Spade Terminals,
Designed for 0.800" hole diameter.

IH Lawn & Garden –

Fits: Cub Cadet: 70, 100, Cub Cadet (SN:
29409 & up)

Momentary Switches

B5004-007	Neutral Safety Switch	\$29.99
	Manual Push Button Safety Switch used as a Neutral Safety Switch. 2 Spade Terminals. 5/8"-32 Thread. 2.575" Total Length. For use as neutral safety switch. International Fits: 100, 1000, 102, 104, 105, 106, 107, 1200, 122, 123, 124, 125, 1250, 126, 127, 1450, 147, 1650, 182, 282, 382, 4000, 5000, 5500, 70, 71, 72, 73, 75, 800, Cub Cadet	

ALTERNATOR CONVERSION KITS

B9021-009	IHC Cub Conversion Kit	\$219.00
	Kit includes: - Mounting Bracket - 12-Volt Small Alternator (1-Wire) - 12-Volt, 3.0 OHM, Black Coil - Instruction Sheet Farmall Cub Fits: (all)	

CIGARETTE LIGHTERS

B9030-003	12 Volt Cigarette Lighter	\$27.99
	The knob is black plastic with the word 'lighter' in white printing Replaces: International - # 378338R91, 378339R91, 378781R91, 382671R91, 382672R91, 393699R91, 1250545C1, 1265632C91 Fits: Cub Cadet - 71, 72, 73, 102, 104, 105, 106, 107, 122, 123, 124, 125, 126, 127	

JOHN BLUE

SPARK PLUG WIRE SETS

John Blue G1000

4 Cyl. Tailored Spark Plug Wire Set

B1027-001	Original Type PVC Wire	\$21.50
B1027-001E	EPDM Wire	\$26.00

WIRING HARNESSSES

John Blue G1000

B3027-007	Complete Wire Harness	\$291.00
------------------	------------------------------	-----------------

TUNE UP PARTS

John Blue G1000

	B4100-007	\$12.75
	PCR Kit Includes: Points (#B4001-015), Condenser (#B4002-011), Rotor (#B4004-011) Replaces: Points - #353172R91 Condenser - #353903R91 Rotor - #353896R91	
	B4003-011	\$13.50
	Cap Replaces: #351693R91, 351693R92 Premium Quality, USA Made with Brass Contacts	
	B4004-011	\$4.75
	Rotor Replaces: #353896R91	
	B4007-003	\$14.99
	Cap Clip 2 Used Replaces: #353894R1	
	B4006-003	\$13.99
	Dust Cover Replaces: #353900R11	
	B4005-004	\$57.99
	Original Style IHC 12 Volt Coil Replaces: #353875R91, 395331R91	

*For 12-Volt Ignition Coils & Accessories, see p.44

JOHN DEERE FARM MACHINERY

TABLE OF CONTENTS

Spark Plug Wire Sets	224
Spark Plug Wire Holders	226
Battery Cables	227
Wire Harnesses	233
Wire Harness Accessories	268
Tune Up Parts (with Distributor)	269
Electronic Conversion Kits	274
Replacement Distributors	274
Tune Up Parts (with Magneto)	275
Magnetos	279
Magneto to Distributor Conversion Kits	280
Gauges	280
Tachometer Drive Cables	284
Fuel Sending Units	285
Fiber Optic Leads	285
Switches	285
Flashers	288
Cutout Relays & Voltage Regulators	289
Generator Repair Kits	290
Starter Repair Kits	291
Identification Tags	291
Alternators	291
Voltage Conversion Kits	292
Starters	292
Starter Switches/Solenoids	293
Lights & Light Parts	294
Auxiliary Plugs & Sockets, Cigarette Lighters	300
Carburetor Rebuild Kits	301
Carburetor Floats, Accessories	302
Fuel Sediment Bowls	303

SPARK PLUG WIRE SETS

Our Spark Plug Wire Sets Come Fully Assembled with the Proper Type Wire & Terminals.

They are Custom Tailored to Look & Fit Like Original Factory Equipment.

Varieties include:

Cotton Braid Wire: Copper Core with a Cotton Jacket.

PVC Wire: Copper Core with a Rubber Jacket.

EPDM Wire (E): Hi Performance Premium Conductor with a Tinned Copper Core, EPDM Silicone Insulation, and a Rubber Jacket.

Suppression Wire (S): for Electronic Ignition and is Spiral Wound, Ultra Low-Ohm, with EPDM Silicone Insulation and a Rubber Jacket.

Cotton Braid Suppression Wire (CS): also for Electronic Ignition, as Suppression Wire, but has an additional layer of Cotton Braid & Lacquer to replicate the vintage look, as well.



Waterloo Boy N

Replaces: #408R

2 Cyl. Tailored Spark Plug Wire Set

B1028-001	Original Type Cotton Braid Wire	\$34.25
B1028-001E	EPDM Wire	\$40.25

John Deere A, AO, & AR

Replaces: #AA1222R, #AA1890R, (Sub for #AA6141R)

2 Cyl. Tailored Spark Plug Wire Set

B1028-003	Original Type Cotton Braid Wire	\$22.75
B1028-003E	EPDM Wire	\$24.50
B1028-003S	Suppression Wire	\$24.50
B1028-003CS	Cotton Suppression wire	\$39.00

John Deere B, BO, BR

Replaces: #AA1222R, #AA1890R, #AB211R, #AB830R,

#AB2604R, (Sub for #AA6141R)

2 Cyl. Tailored Spark Plug Wire Set

B1028-005	Original Type Cotton Braid Wire	\$22.75
B1028-005E	EPDM Wire	\$24.50
B1028-005S	Suppression Wire	\$24.50
B1028-005CS	Cotton Suppression Wire	\$39.00

John Deere D

with WICO Magneto

Replaces: #AA6142R (Sub for #AD26R, #AD27R)

2 Cyl. Tailored Spark Plug Wire Set

B1028-007	Original Type Cotton Braid Wire	\$23.75
B1028-007E	EPDM Wire	\$26.00

with Edison Splitdorf Magneto

Replaces: #AC1013R (Sub for #AD1415R), #AA6142R (Sub for #AD1416R)

2 Cyl. Tailored Spark Plug Wire Set

B1028-064	Original Type Cotton Braid Wire	\$23.75
B1028-064E	EPDM Wire	\$26.00

John Deere G, GM

Replaces: #AC1013R (Sub for #AD1454R, #AD1415R), #AA6141R

(Sub for #AA1222R, #AA1890R)

2 Cyl. Tailored Spark Plug Wire Set

B1028-009	Original Type Cotton Braid Wire	\$22.75
B1028-009E	EPDM Wire	\$24.50
B1028-009S	Suppression Wire	\$24.50
B1028-009CS	Cotton Suppression wire	\$39.00

John Deere GP

Replaces: #AD529R

2 Cyl. Tailored Spark Plug Wire Set

B1028-011	Original Type Cotton Braid Wire	\$23.75
B1028-011E	EPDM Wire	\$26.00

John Deere H

Replaces: #AA1890R, #AH655R

2 Cyl. Tailored Spark Plug Wire Set

B1028-013	Original Type Cotton Braid Wire	\$26.25
B1028-013E	EPDM Wire	\$28.75
B1028-013S	Suppression Wire	\$28.75

John Deere L, LA, LI

Replaces: #AL2923T

2 Cyl. Tailored Spark Plug Wire Set

B1028-015	Original Type Cotton Braid Wire	\$23.75
B1028-015E	EPDM Wire	\$26.00

John Deere M, MC, MI, MT

Replaces: #AM3055T (Sub for #AM376T), #AM374T

2 Cyl. Tailored Spark Plug Wire Set

B1028-020	Original Type Cotton Braid Wire	\$21.00
B1028-020E	EPDM Wire	\$23.25
B1028-020S	Suppression Wire	\$23.25
B1028-020CS	Cotton Suppression wire	\$37.25

John Deere R

Cranking Motor; Replaces: #AB3481R, A3559R

2 Cyl. Tailored Spark Plug Wire Set

B1028-025	Original Type Cotton Braid Wire	\$22.75
B1028-025E	EPDM Wire	\$24.50

John Deere 40

Replaces: #AM3055T (Sub for #AM376T), #AM374T

2 Cyl. Tailored Spark Plug Wire Set

B1028-020	Original Type Cotton Braid Wire	\$21.00
B1028-020E	EPDM Wire	\$23.25
B1028-020S	Suppression Wire	\$23.25
B1028-020CS	Cotton Suppression wire	\$37.25

John Deere 50

Replaces: #AA6141R (Sub for #AB3480R, #AA5976R)

2 Cyl. Tailored Spark Plug Wire Set

B1028-027	Original Type PVC Wire	\$16.00
B1028-027E	EPDM Wire	\$17.50
B1028-027S	Suppression Wire	\$17.50

John Deere 60

Replaces: #AA6141R (Sub for #AA1890R, #AA5976R)

2 Cyl. Tailored Spark Plug Wire Set

B1028-028	Original Type PVC Wire	\$16.00
B1028-028E	EPDM Wire	\$17.50
B1028-028S	Suppression Wire	\$17.50

John Deere 70 Gas

Replaces: #AA6141R

2 Cyl. Tailored Spark Plug Wire Set

B1028-029	Original Type PVC Wire	\$16.00
B1028-029E	EPDM Wire	\$17.50
B1028-029S	Suppression Wire	\$17.50

John Deere 70 Diesel

Cranking Motor; Replaces: #X9274, #X9652 (Sub for #AR12004R),

#X9275, #X9653 (Sub for #AR12005R)

4 Cyl. Tailored Spark Plug Wire Set

B1028-030	Original Type PVC Wire	\$24.75
------------------	-------------------------------	----------------

John Deere 70 Skid Steer

2 Cyl. Tailored Spark Plug Wire Set

B1028-071	Original Type EPDM Wire	\$17.75
------------------	--------------------------------	----------------

John Deere 80 Diesel

Cranking Motor; Replaces: #X9652 (Sub for #AR12004R), #X9653

(Sub for #AR12005R)

4 Cyl. Tailored Spark Plug Wire Set

B1028-030	Original Type PVC Wire	\$24.75
------------------	-------------------------------	----------------

John Deere 310 Industrial

Replaces: #AR50270 (Sub for #T23428, #T23429, #T23430, #T23431)

3 Cyl. Tailored Spark Plug Wire Set

B1028-049	Original Type PVC Wire	\$21.50
B1028-049E	EPDM Wire	\$26.00
B1028-049S	Suppression Wire	\$26.00

John Deere 320, 330, 420*, 430, & 440

*Note: The 420 is listed for the Farm Tractor Only.

For the Lawn & Garden Tractor, use B1029-005 instead

Replaces: #AM3055T, #AM374T

2 Cyl. Tailored Spark Plug Wire Set

B1028-032	Original Type PVC Wire	\$17.00
B1028-032E	EPDM Wire	\$18.25
B1028-032S	Suppression Wire	\$18.25

John Deere 520, 530, 620, 630, 720, 730

Gas

Replaces: #AA6141R

2 Cyl. Tailored Spark Plug Wire Set

B1028-037	Original Type PVC Wire	\$16.00
B1028-037E	EPDM Wire	\$17.50
B1028-037S	Suppression Wire	\$17.50

John Deere 720, 730, 820, 830, 840 Diesel

Cranking Motor; Replaces: #AR30963R, #X9652 (Sub for

#AR12004R), #X9653 (Sub for #AR12005R)

4 Cyl. Tailored Spark Plug Wire Set

B1028-030	Original Type PVC Wire	\$24.75
------------------	-------------------------------	----------------

John Deere 1010

Replaces: #AT24384 (Sub for #AT161T, #AT162T, #AT163T)

4 Cyl. Tailored Spark Plug Wire Set

B1028-048	Original Type PVC Wire	\$21.50
B1028-048E	EPDM Wire	\$26.00
B1028-048S	Suppression Wire	\$26.00

John Deere 1020

Replaces: #AR50270 (Sub for #T23428, #T23429, #T23430, #T23431)

3 Cyl. Tailored Spark Plug Wire Set

B1028-049	Original Type PVC Wire	\$21.50
B1028-049E	EPDM Wire	\$26.00
B1028-049S	Suppression Wire	\$26.00

John Deere 1520

Replaces: #AR50270 (Sub for #T23428, #T23429, #T23430, #T23431)

3 Cyl. Tailored Spark Plug Wire Set

B1028-050	Original Type PVC Wire	\$21.50
B1028-050E	EPDM Wire	\$26.00
B1028-050S	Suppression Wire	\$26.00

John Deere 2010

Replaces: #AR30963R (Sub for #AT161T, #AT162T, #AT163T)

4 Cyl. Tailored Spark Plug Wire Set

B1028-051	Original Type PVC Wire	\$21.50
B1028-051E	EPDM Wire	\$26.00
B1028-051S	Suppression Wire	\$26.00

John Deere 2010 Industrial

Replaces: #AT24384 (Sub for #AT161T, #AT162T, #AT163T)

4 Cyl. Tailored Spark Plug Wire Set

B1028-052	Original Type PVC Wire	\$21.50
B1028-052E	EPDM Wire	\$26.00
B1028-052S	Suppression Wire	\$26.00

John Deere 2020

Replaces: #R32006, #R32013, #A3539R (Sub for #T23428,

#T23429, #T23430, #T23432)

4 Cyl. Tailored Spark Plug Wire Set

B1028-053	Original Type PVC Wire	\$21.50
B1028-053E	EPDM Wire	\$26.00
B1028-053S	Suppression Wire	\$26.00

John Deere 2030

Replaces: #R32006, #R32013, #A3539R

4 Cyl. Tailored Spark Plug Wire Set

B1028-069	Original Type PVC Wire	\$21.50
B1028-069E	EPDM Wire	\$26.00
B1028-069S	Suppression Wire	\$26.00

John Deere 2510, 2520

Replaces: #AR50270, #AR38807

4 Cyl. Tailored Spark Plug Wire Set

B1028-054	Original Type PVC Wire	\$21.50
B1028-054E	EPDM Wire	\$26.00
B1028-054S	Suppression Wire	\$26.00

John Deere 3010

Replaces: #AR30963R

4 Cyl. Tailored Spark Plug Wire Set

B1028-056	Original Type PVC Wire	\$21.50
B1028-056E	EPDM Wire	\$26.00
B1028-056S	Suppression Wire	\$26.00

John Deere 3020

Replaces: #AR50270

4 Cyl. Tailored Spark Plug Wire Set

B1028-057	Original Type PVC Wire	\$21.50
B1028-057E	EPDM Wire	\$26.00
B1028-057S	Suppression Wire	\$26.00

John Deere 4000, 4010, 4020

Replaces: #AR46275, #AR46273

6 Cyl. Tailored Spark Plug Wire Set

B1028-058	Original Type PVC Wire	\$32.50
B1028-058E	EPDM Wire	\$39.25
B1028-058S	Suppression Wire	\$39.25

John Deere Semi-Tailored Fit

2 Cyl. Tailored Spark Plug Wire Set

B1028-062	Modern Type PVC Wire	\$14.50
B1028-063	Original Type Cotton Braid Wire	\$21.50

~Combines~

John Deere 25 Combine

4 Cyl. Tailored Spark Plug Wire Set

B1028-060	Original Type PVC Wire	\$35.75
B1028-060E	EPDM Wire	\$43.25

John Deere 45 Combine

6 Cyl. Tailored Spark Plug Wire Set

B1028-058	Original Type PVC Wire	\$32.50
B1028-058E	EPDM Wire	\$39.25
B1028-058S	Suppression Wire	\$39.25

John Deere 3300 Combine

6 Cyl. Tailored Spark Plug Wire Set

B1028-070	Original Type PVC Wire	\$21.50
B1028-070E	EPDM Wire	\$26.00
B1028-070S	Suppression Wire	\$26.00

SPARK PLUG WIRE HOLDERS

B9034-001	John Deere Rubber Spark Plug Holder	\$6.99
------------------	--	---------------



Rubber Spark Plug Wire Holder fits John Deere Unstyled A, B, G, 2 Cylinder models, (Styled A, B & G), 50, 60 & 70 Replaces: #A470R

B9033-003	John Deere Spark Plug Wire Bracket Grommet	\$0.50
------------------	---	---------------



Grommet for spark plug wire bracket on John Deere 2 Cyl. 50, 60, 70, 520, 530, 620, 630, 720, 730 Gas tractors (Note: 4 used per tractor)

B9034-002	John Deere D Wooden Spark Plug Wire Holder Set	\$25.00
------------------	---	----------------





Wooden Spark Plug Wire Holder set fits John Deere D

B9034-003	John Deere GP Wooden Spark Plug Wire Holder Set	\$25.00
------------------	--	----------------



Wooden Spark Plug Wire Holder set fits John Deere GP

B9034-004	Large Individual Wooden Spark Plug Wire Holder Block	\$10.00
	for use with John Deere Tractors	

B9034-005	Small Individual Wooden Spark Plug Wire Holder Block	\$10.00
	for use with John Deere Tractors	

BATTERY CABLES

Our Battery Cables are made from the Proper Gauge Copper, as either Black Cotton Braided Wire or PVC Wire (whichever is correct for the application), using Soldered & Heat Sealed Brass or Copper Terminals.

John Deere A (Up to Serial #583,999 Late 1947)

B2028-001	Negative Battery Cable	\$40.00
Replaces: #AA4422R (Sub for #AB1842R)		
B2000-006	Positive Battery Strap	\$13.50
Replaces: #AB1197R		

John Deere A (Serial #584000 & up, Late 1947)

B2028-002	Negative Battery Cable	\$78.75
B2028-131	with Original Armor	\$98.75
Replaces: #AB3546R (Sub for #AA3996R)		
B2000-006	Positive Ground Strap	\$13.50
Replaces: #AB1833R		
B2028-003	Battery to Battery Jumper Cable	\$29.00
Replaces: #AD2091R (Sub for #AA4039R)		

John Deere AO (Serial #250,000-271,999)

B2028-004	Negative Battery Cable	\$45.00
Replaces: #AA4422R (Sub for #AB1842R)		
B2000-006	Positive Battery Strap	\$13.50
Replaces: #AB1197R		

John Deere AO (Serial #272,000, & Up)

B2028-005	Negative Battery Cable	\$46.75
Replaces: #AA4422R		
B2000-004	Positive Battery Strap	\$10.50
Replaces: #AB1833R		
B2028-006	Battery to Battery Jumper Cable	\$56.00
Replaces: #AA4423R		

John Deere AR (Serial #250,000-271,999)

B2028-007	Negative Battery Cable	\$45.00
Replaces: #AA4422R (Sub for #AB1842R)		
B2000-006	Positive Battery Strap	\$13.50
Replaces: #AB1197R		

John Deere AR (Serial #272,000, & Up)

B2028-005	Negative Battery Cable	\$46.75
Replaces: #AA4422R		
B2000-004	Positive Battery Strap	\$10.50
Replaces: #AB1833R		
B2028-006	Battery to Battery Jumper Cable	\$56.00
Replaces: #AA4423R		

John Deere B (Up to Serial #200,999, Late 1947)

B2028-010	Negative Battery Cable	\$45.00
Replaces: #AB1968R		
B2000-006	Positive Battery Strap	\$13.50
Replaces: #AB1197R		

John Deere B (Serial #201,000 & Up, Late 1947 and up)

B2028-011	Negative Battery Cable	\$78.75
B2028-130	with Original Armor	\$98.75
Replaces: #AB3546R		
B2000-006	Positive Battery Strap	\$13.50
Replaces: #AB1833R (Sub for #AB3449R)		

John Deere BO

B2028-012	Negative Battery Cable	\$33.00
Replaces: #AB1968R		
B2000-006	Positive Battery Strap	\$13.50
Replaces: #AB1197R		

John Deere BR

B2028-013	Negative Battery Cable	\$33.00
Replaces: #AB1968R		
B2000-006	Positive Battery Strap	\$13.50
Replaces: #AB1197R		

John Deere D

B2028-014	Negative Battery Cable	\$45.00
Replaces: #AA4422R (Sub for #AB2081R)		
B2000-008	Positive Battery Strap	\$15.50
Replaces: #AB1197R (Sub for #AD2568R)		
B2028-015	Battery to Battery Jumper Cable	\$24.00
Replaces: #AD2091R		

John Deere G, GM (Serial #13,000 to 25,999)

B2028-016	Negative Battery Cable	\$84.25
B2028-146	with Original Armor	\$104.25
Replaces: #AR1353R		
B2000-006	Positive Battery Strap	\$13.50
Replaces: #AB1833R		
B2028-017	Battery to Battery Jumper Cable	\$22.75
Replaces: #AA4039R		

John Deere G (Serial #26,000 & up)

B2028-020	Negative Battery Cable	\$78.75
B2028-126	with Original Armor	\$98.75
Replaces: #AB3546R		
B2000-007	Positive Battery Strap	\$14.50
Replaces: #AB1833R		
B2028-021	Battery to Battery Jumper Cable	\$22.75
Replaces: #AA4039R (Sub for #AD2091R)		

John Deere H

B2028-022	Negative Battery Cable	\$59.25
B2028-090	with Original Armor	\$79.25
Replaces: #AH969R		
B2000-005	Positive Battery Strap	\$12.50
Replaces: #AB1833R		

John Deere L, LA, LI

B2028-023	Negative Battery Cable	\$35.75
Replaces: #AL2822T		
B2000-004	Positive Battery Strap	\$10.50
Replaces: #AL2823T		

John Deere M

B2028-025	Negative Battery Cable	\$26.25
Replaces: #AM349T		
B2000-002	Positive Battery Strap	\$9.50
Replaces: #AM348T		

John Deere MC

B2028-026	Negative Battery Cable	\$26.25
Replaces: #AM349T		
B2000-002	Positive Battery Strap	\$9.50
Replaces: #AM348T		

John Deere MI

B2028-027	Negative Battery Cable	\$26.25
Replaces: #AM349T		
B2000-002	Positive Battery Strap	\$9.50
Replaces: #AM348T		

John Deere MT

B2028-028	Negative Battery Cable	\$26.25
Replaces: #AM349T		
B2000-002	Positive Battery Strap	\$9.50
Replaces: #AM348T		

John Deere R

B2028-029	Negative Battery Cable	\$97.50
B2028-148	with Original Armor	\$117.50
Replaces: #AR1353R (Sub. For #AR511R)		
B2000-002	Positive Battery Strap	\$9.50
Replaces: #AB1833R		

John Deere 40

B2028-030	Negative Battery Cable	\$26.25
Replaces: #AM349T		
B2000-002	Positive Battery Strap	\$9.50
Replaces: #AM348T		

John Deere 50

B2028-031	Negative Battery Cable	\$78.75
B2028-129	with Original Armor	\$98.75
Replaces: #AB3546R		
B2000-002	Positive Battery Strap	\$9.50
Replaces: #AB4100R (Sub for #AB3449R)		
B2028-032	Battery to Battery Jumper Cable	\$31.00
Replaces: #AA4309R		

John Deere 60

B2028-033	Negative Battery Cable	\$78.75
B2028-128	with Original Armor	\$98.25
Replaces: #AB3546R (Sub for #AA3996R)		
B2000-004	Positive Battery Strap	\$10.50
Replaces: #AB4100R (Sub for #AB1833R)		
B2028-034	Battery to Battery Jumper Cable	\$31.00
Replaces: #AA4039R (Sub for #AD2091R)		

John Deere 60 Orchard

B2028-005	Negative Battery Cable	\$46.75
Replaces: #AB3546R (Sub for #AA3996R)		
B2000-004	Positive Battery Strap	\$10.50
Replaces: #AB4100R (Sub for #AB1833R)		
B2028-006	Battery to Battery Jumper Cable	\$56.00
Replaces: #AA4039R (Sub for #AD2091R)		

John Deere 60 Standard

(Up to Serial #6,042,999)

B2028-005	Negative Battery Cable	\$46.75
Replaces: #AB3546R (Sub for #AA3996R)		
B2000-004	Positive Battery Strap	\$10.50
Replaces: #AB4100R (Sub for #AB1833R)		
B2028-006	Battery to Battery Jumper Cable	\$56.00
Replaces: #AA4039R (Sub for #AD2091R)		

John Deere 70 Gas

B2028-035	Negative Battery Cable	\$88.00
B2028-127	with Original Armor	\$108.00
Replaces: #AF1579R, #AF1754R		
B2000-002	Positive Battery Strap	\$9.50
Replaces: #AB4100R		
B2028-036	Battery to Battery Jumper Cable	\$22.75
Replaces: #AA4039R (Sub for #AD2091R)		

John Deere 70 Diesel

B2028-037	Negative Battery Cable	\$78.75
B2028-125	with Original Armor	\$98.75
Replaces: #AB3546R		
B2000-002	Positive Battery Strap	\$9.50
Replaces: #AB4100R		

John Deere 80 Diesel

B2028-038	Negative Battery Cable	\$103.00
B2028-145	with Original Armor	\$123.00
Replaces: #AR1353R		
B2000-002	Positive Battery Strap	\$9.50
Replaces: #AB4100R		

John Deere 320

B2028-039	Negative Battery Cable	\$26.25
Replaces: #AM349T		
B2000-002	Positive Battery Strap	\$9.50
Replaces: #AL2823T		

John Deere 330

B2028-040	Negative Battery Cable	\$27.75
Replaces: #AT10309T		
B2000-002	Positive Battery Strap	\$9.50
Replaces: #AL2823T		

John Deere 420

B2028-041	Negative Battery Cable	\$26.25
Replaces: #AM349T		
B2000-002	Positive Battery Strap	\$9.50
Replaces: #AL2823T		

John Deere 430

B2028-042	Negative Battery Cable	\$27.75
Replaces: #AT10309T		
B2000-002	Positive Battery Strap	\$9.50
Replaces: #AL2823T		

John Deere 435 Diesel

B2028-043	Negative Battery Cable	\$30.00
Replaces: #AL2822T (Sub for #AT10309T)		
B2000-005	Positive Battery Strap	\$12.50
Replaces: #AT11516T		

John Deere 440 Gas

B2028-045	Negative Battery Cable	\$27.75
Replaces: #AT10309T		
B2000-002	Positive Battery Strap	\$9.50
Replaces: #AL2823T		

John Deere 440 Diesel

B2028-046	Negative Battery Cable	\$30.00
Replaces: #AL2822T (Sub for #AT10309T)		
B2000-005	Positive Battery Strap	\$12.50
Replaces: #AT11516T		

John Deere 450E Crawler w/ Factory Disconnect Switch

B2000-002	Negative Battery Strap (2 Used)	\$9.50
Replaces: #AT41189		
B2028-162	Positive Battery Cable	\$52.75
Replaces: #AT18702		

John Deere 520

B2028-048	Negative Battery Cable	\$78.75
B2028-106	with Original Armor	\$98.75
Replaces: #AB3546R		
B2000-004	Positive Battery Strap	\$10.50
Replaces: #AB4100R		
B2028-049	Battery to Battery Jumper Cable	\$22.75
Replaces: #AA4039R (Sub for #AD2091R)		

John Deere 530

B2028-050	Negative Battery Cable	\$78.75
B2028-134	with Original Armor	\$98.75
Replaces: #AR20253R See more JD 530 cables, top of next column		

B2000-004	Positive Battery Strap	\$10.50
Replaces: #AB4100R-		
B2028-051	Battery to Battery Jumper Cable	\$22.75
Replaces: #AA4039R		

John Deere 620

B2028-052	Negative Battery Cable	\$78.75
B2028-105	with Original Armor	\$98.75
Replaces: #AB3546R		
B2000-004	Positive Battery Strap	\$10.50
Replaces: #AB4100R		
B2028-053	Battery to Battery Jumper Cable	\$22.75
Replaces: #AA4039R (Sub for #AD2091R)		

John Deere 630

B2028-054	Negative Battery Cable	\$95.50
B2028-139	with Original Armor	\$115.50
Replaces: #AR20256R		
B2000-004	Positive Battery Strap	\$10.50
Replaces: #AB4100R		
B2028-055	Battery to Battery Jumper Cable	\$22.75
Replaces: #AA4039R		

John Deere 720 Gas

B2028-056	Negative Battery Cable	\$95.50
B2028-139	with Original Armor	\$115.50
Replaces: #AF1754R		
B2000-004	Positive Battery Strap	\$10.50
Replaces: #AB4100R		
B2028-057	Battery to Battery Jumper Cable	\$29.00
Replaces: #AA4039 (Sub for #AD2091R)		

John Deere 720 Diesel Electric Start

B2028-058	Negative Battery Cable	\$86.25
Replaces: #AR20217R		
B2028-059	Positive Battery Cable	\$75.75
Replaces: #AR20216R		
B2028-060	Switch to Starter Cable	\$30.00
Replaces: #AR11029R		
B2028-057	Battery to Battery Jumper Cable	\$29.00
(1 Piece) Used with Two 12-Volt Batteries Replaces: #AA4039R		
B2028-062	Center of Batteries to Ground Cable	\$17.50
Replaces: #AR20218R		

John Deere 720 Diesel Pony Start

B2028-063	Negative Battery Cable	\$78.75
B2028-143	with Original Armor	\$98.75
Replaces: #AB3546R		
B2000-004	Positive Battery Strap	\$10.50
Replaces: #AB4100R		

John Deere 730 Gas

B2028-064	Negative Battery Cable	\$73.25
B2028-104	with Original Armor	\$93.25
Replaces: #AR20256R		
B2000-004	Positive Battery Strap	\$10.50
Replaces: #AB4100R		
B2028-065	Battery to Battery Jumper Cable	\$31.00
Replaces: #AA4039R		

John Deere 730 Diesel Electric Start

B2028-066	Negative Battery Cable	\$66.75
Replaces: #AR20216R		
B2028-067	Positive Battery Cable	\$63.25
Replaces: #AR20216R		
B2028-057	Battery to Battery Jumper Cable	\$29.00
(1 Piece) Used with Two 12-Volt Batteries		
Replaces: #AA4039R		
B2028-069	Switch to Starter Cable	\$26.75
Replaces: #AR11029R		
B2028-062	Center of Batteries to Ground Cable	\$17.50
Replaces: #AR20218R		

John Deere 730 Diesel Pony Start

B2028-071	Negative Battery Cable	\$78.75
B2028-149	with Original Armor	\$98.75
Replaces: #AB3546R		
B2000-004	Positive Battery Strap	\$10.50
Replaces: #AB4100R		

John Deere 820, 830 Diesel Pony Start

For American Made 2-Cylinder Tractors Only.
(Does Not Fit German Made 3-Cylinders.)

B2028-038	Negative Battery Cable	\$103.00
B2028-145	with Original Armor	\$123.00
Replaces: #AR1353R		
B2000-004	Positive Battery Strap	\$10.50
Replaces: #AB4100R		

John Deere 830, 840 Diesel Electric Start

For American Made 2-Cylinder Tractors Only.
(Does Not Fit German Made 3-Cylinders.)

B2028-074	Negative Battery Cable	\$94.75
Replaces: #AR20566R		
B2028-075	Positive Battery Cable	\$94.75
Replaces: #AR20565R		
B2028-069	Switch to Starter Cable	\$26.75
Replaces: #AR11029R		
B2028-057	Battery to Battery Jumper Cable	\$29.00
(1 Piece) Used with Two 12-Volt Batteries		
Replaces: #AA4039R		
B2028-062	Center of Batteries to Ground Cable	\$17.50
Replaces: #AR2021SR		

John Deere 1010 Gas, Diesel

B2028-089	Negative Battery Cable	\$42.00
Replaces: #AT13528T		
B2000-007	Positive Ground Strap	\$14.50
Replaces: #AL2823T		

John Deere 1020

B2028-093	Negative Battery Cable	\$31.75
Replaces: #AR103525 (Sub for #T21887)		
B2000-004	Positive Ground Strap	\$10.50
Replaces: #AR67453		

John Deere 2010 Gas

B2028-151	Negative Battery Cable	\$44.75
Replaces: #AT16286 (Sub for #AT21644)		
B2000-006	Positive Ground Strap	\$13.50
Replaces: #AB1833R		

John Deere 2030 Gas

B2028-111	Negative Battery Cable	\$30.75
Replaces: #AR103525 (Sub for #T21887)		
B2028-112	Positive Battery Cable	\$30.75
Replaces: #AR67453		

John Deere 2240 Diesel

B2028-095	Negative Battery Cable	\$47.25
Replaces: #AR67453		
B2028-096	Positive Battery Cable	\$53.25
Replaces: #T21887		

John Deere 2510 Gas & LP Row Crop (All)

Original Design with 1 Battery

B2000-005	11" Negative Ground Strap	\$12.50
Replaces: #AR26619 & AR26622		
B2028-136	Positive Battery Cable	\$65.25
Replaces: #AR45923		

John Deere 2510 Diesel Row Crop (All)

Original Design with Two 12-Volt batteries

B2000-005	11" Negative Ground Strap	\$12.50
Replaces: #AR26619 & AR26622		*Two Used*
B2028-136	Positive Battery Cable	\$65.25
Replaces: #AR45923		*Two Used*

John Deere 2520 Diesel Row Crop (All)

Original Design with Two 6-Volt Batteries

B2028-140	Negative Battery Cable	\$31.25
Replaces: #AR51395		
B2028-136	Positive Battery Cable	\$65.25
Replaces: #AR45923		
B2028-142	Battery to Battery Jumper Cable	\$60.75
Replaces: #AR48912		

John Deere 2520 Gas Row Crop (All)

Original Design with One 12-Volt Battery

B2028-140	Negative Battery Cable	\$31.25
Replaces: #AR51395		
B2028-136	Positive Battery Cable	\$65.25
Replaces: #AR45923		

John Deere 3010 Gas, & LP Row Crop

B2028-101	Negative Battery Cable, 24-Volt Only	\$44.00
Replaces: #AR28950		
B2000-006	Positive Ground Strap	\$13.50
Replaces: #AR26619		

John Deere 3010 Gas Utility

B2028-098	Negative Battery Cable	\$61.00
Replaces: #AR30388 (Sub for #AR27365)		

John Deere 3010 Diesel Row Crop

Original Design, 24-Volt

B2028-101	Negative Battery Cable	\$44.00
Replaces: #AR28950		
B2028-102	Positive Battery Cable	\$69.25
Replaces: #AR26621		
B2000-005	Battery to Ground Cable	\$12.50
2 Used Replaces: #AR26619, Flat Braided Positive Ground Strap #AR26622, Flat Braided Negative Ground Strap		

12-Volt Conversion

B2028-161	Positive Battery Cable (Left Side)	\$44.00
B2028-102	Positive Battery Cable (Right Side)	\$69.25
Replaces: #AR26621		
B2000-005	Negative Ground Cable (2 Used)	\$12.50

John Deere 3010 Diesel Utility

Original Design, 24-Volt

B2028-099	Negative Battery Cable	\$51.75
Replaces: #AR27366		
B2028-100	Positive Battery Cable	\$66.75
Replaces: #AR30388 (Sub For #AR27365 Positive Battery Cable)		
B2000-005	Battery to Ground Cable (2 Used)	\$12.50
Replaces: #AR26619, Flat Braided Positive Ground Strap #AR26622, Flat Braided Negative Ground Strap		

John Deere 3020 Gas (Up to Serial 122,999)

B2000-007	Positive Ground Strap	\$14.50
B2028-101	Negative Battery Cable	\$44.00
with Synchro Range (Serial #68,000 to 122,999) Replaces: #AR28950		

John Deere 3020 Diesel Row Crop

-Up To Serial #67,999-

Original 24 Volt

B2028-101	Negative Battery Cable (Left Side)	\$44.00
with Synchro Range, Replaces: #AR28950		
B2028-102	Positive Battery Cable	\$69.25
with Synchro Range, Replaces: #AR26621		
B2028-138	Negative Battery Cable	\$49.25
with Power Shift, Replaces: #AR33659		
B2028-137	Positive Battery Cable	\$50.75
with Power Shift, Replaces: #AR33660		
B2000-005	Battery to Ground Cable (2 Used)	\$12.50
Replaces: #AR26619, Flat Braided Positive Ground Strap #AR26622, Flat Braided Negative Ground Strap		

Modified for 12-Volt Negative Ground Alternator

B2028-161	Positive Battery Cable (Left Side)	\$44.00
with Synchro Range, Replaces: #AR28950		
B2028-102	Positive Battery Cable (Right Side)	\$69.25
with Synchro Range, Replaces: #AR26621		
B2000-005	Negative Ground Cable (2 Used)	\$12.50

-Serial #68,000 to 122,999-

Original Design, 24 Volt

B2028-101	Negative Battery Cable	\$44.00
with Synchro Range, Replaces: #AR28950		
B2028-138	Negative Battery Cable	\$49.25
with Power Shift, Replaces: #AR33659		
B2028-136	Positive Battery Cable	\$65.25
Replaces: #AR45923		
B2028-107	Battery to Battery Jumper Cable	\$50.25
Replaces: #AR40409 (#Sub for R39712)		
B2028-135	Center of Batteries to Ground Cable	\$21.00
Replaces: #AR47412, Center of Batteries to Ground with Fuse Holder		

Modified for 12-Volt Negative Ground Alternator

B2028-161	Positive Battery Cable (Left Side)	\$44.00
with Synchro Range, Replaces: #AR28950		

B2028-136	Positive Battery Cable (Right Side)	\$65.25
Replaces: #AR45923		
B2000-005	Negative Ground Cable (2 Used)	\$12.50

-Serial #123,000 to 150,000-

B2028-108	Negative Battery Cable	\$31.25
Replaces: #AR38565 & AR45925		
B2028-136	Positive Battery Cable	\$65.25
Replaces: #AR45923		
B2028-110	Battery to Battery Jumper Cable	\$50.25
Replaces: #AR45924		

-Serial #150,001 & Up-

B2028-140	Negative Battery Cable	\$31.25
Replaces: #AR51395		
B2028-141	Positive Battery Cable	\$52.00
Replaces: #AR51394		
B2028-142	Battery to Battery Jumper Cable	\$60.75
Replaces: #AR48912		

John Deere 3020 Gas Row Crop

-Serial #123,000 to 150,000-

B2028-108	Negative Battery Cable	\$31.25
Replaces: #AR38565, & AR45925		
B2028-136	Positive Battery Cable	\$65.25
Replaces: #AR45923		

-Serial #150,001 & Up-

B2028-140	Negative Battery Cable	\$31.25
Replaces: #AR51395		
B2028-147	Positive Battery Cable	\$56.00
Replaces: #AR45926		

John Deere 4010 Gas & LP Row Crop

B2028-101	Negative Battery Cable	\$44.00
Replaces: #AR28950		
B2000-006	Positive Ground Strap	\$13.50
Replaces: #AR26619		

John Deere 4010 Diesel

Original Design, 24 Volt

B2028-101	Negative Battery Cable	\$44.00
Replaces: #AR28950		
B2028-102	Positive Battery Cable	\$69.25
Replaces: #AR26621		
B2000-005	Battery to Ground Cable (2 Used)	\$12.50
Replaces: #AR26619, Flat Braided Positive Ground Strap #AR26622, Flat Braided Negative Ground Strap		

Modified for 12-Volt Negative Ground Alternator

B2028-161	Positive Battery Cable (Left Side)	\$44.00
with Synchro Range, Replaces: #AR28950		
B2028-102	Positive Battery Cable (Right Side)	\$69.25
with Synchro Range, Replaces: #AR26621		
B2000-005	Negative Ground Cable (2 Used)	\$12.50

John Deere 4020 Gas Row Crop

(Up to Serial #200,999, with Open Operator Station)

B2028-101	Negative Battery Cable (Left Side)	\$44.00
Replaces: #AR28950		
B2000-006	Positive Ground Strap	\$13.50
Replaces: #AR26619		

John Deere 4020 Diesel Row Crop

-Up to Serial #90,999-

Original 24-Volt

B2028-101	Negative Battery Cable (Left Side)	\$44.00
Replaces: #AR28950		
B2028-102	Positive Battery Cable	\$69.25
with Synchro Range, Replaces: #AR26621		
B2028-116	Positive Battery Cable	\$72.75
with Power Shift, Replaces: #AR34555		
B2000-005	Battery to Ground Cable	\$12.50
2 Used Replaces: #AR26619, Flat Braided Positive Ground Strap, #AR26622, Flat Braided Negative Ground Strap		

Modified for 12-Volt Negative Ground Alternator

B2028-161	Positive Battery Cable (Left Side)	\$44.00
with Synchro Range, Replaces: #AR28950		
B2028-102	Positive Battery Cable (Right Side)	\$69.25
with Synchro Range, Replaces: #AR26621		
B2000-005	Negative Ground Cable (*2 Used*)	\$12.50

-Serial #91,000 to 200,999-

Original Design, 24-Volt

B2028-101	Negative Battery Cable (Left Side)	\$44.00
Replaces: #AR28950		
B2028-136	Positive Battery Cable	\$65.25
Replaces: #AR40408, AR45923 (Sub for #R39719)		
B2028-107	Battery to Battery Jumper Cable	\$50.25
Replaces: #AR40409 (Sub For #R39712)		

Modified for 12-Volt Negative Ground Alternator

B2028-161	Positive Battery Cable (Left Side)	\$44.00
Replaces: #AR28950		
B2028-136	Positive Battery Cable (Right Side)	\$65.25
Replaces: #AR40408, AR45923 (Sub for #R39719)		
B2000-005	Negative Ground Cable (*2 Used*)	\$12.50

-Serial #201,000 to 250,000-

B2028-108	Negative Battery Cable	\$31.25
Replaces: #AR45925		
B2028-136	Positive Battery Cable	\$65.25
Replaces: #AR40408, AR45923 (Sub for #R39719)		
B2028-120	Battery to Battery Jumper Cable	\$55.75
Replaces: #AR45924		

-Serial #250,001 & Up-

B2028-108	Negative Battery Cable	\$31.25
Replaces: #AR45925		
B2028-150	Positive Battery Cable	\$52.00
Replaces: #AR5194		
B2028-120	Battery to Battery Jumper Cable	\$55.75
Replaces: #AR45924		

John Deere 4040, 4240, 4440

Original Design with Cab

B2028-154	Negative Battery Cable	\$31.50
Replaces: #RE21740, AR60012		
B2028-155	Positive Battery Cable	\$38.75
Replaces: #AR56949		
B2028-156	Battery to Battery Jumper Cable	\$72.50
Replaces: #RE21741, AR57099		

Modified for Group 31 Stud Post Batteries with Cab

B2028-157	Positive Left Battery Cable	\$28.50
Replaces: JD #AR56949 (modified)		
B2028-158	Negative Right Battery Cable	\$27.75
Replaces: #RE21740, AR60012 (modified)		
B2028-159	Negative Left Battery Cable	\$34.25
B2028-160	Positive Right Battery Cable	\$71.25
Replaces: #RE21741, AR57099 (modified)		

John Deere 4320 Diesel Row Crop

Original Design with Two 6-Volt Batteries

B2028-141	Positive Battery Cable	\$52.00
Replaces: #AR51394		
B2028-140	Negative Battery Cable	\$31.25
Replaces: #AR51395		
B2028-142	Battery to Battery Jumper Cable	\$60.75
Replaces: #AR48912		

John Deere 4520 Diesel Row Crop

Original Design with Two 6-Volt Batteries

with Synchro Range Transmission

B2028-140	Negative Battery Cable	\$31.25
Replaces: #AR51395		
B2028-141	Positive Battery Cable	\$52.00
Replaces: #AR51394		
B2028-142	Battery to Battery Jumper Cable	\$60.75
Replaces: #AR48912		

with Power Shift Transmission

B2028-140	Negative Battery Cable	\$31.25
Replaces: #AR51395		
B2028-136	Positive Battery Cable	\$65.25
Replaces: #AR45923		
B2028-142	Battery to Battery Jumper Cable	\$60.75
Replaces: #AR48912		

John Deere 5010

B2028-121	Negative Battery Cable	\$48.00
Replaces: #AR35212		
B2000-006	Positive Ground Strap	\$13.50
Replaces: #AR26619		
B2000-010	Positive Ground Strap	\$21.75
Replaces: #R39713		
B2028-122	Battery to Battery Jumper Set	\$31.00
Replaces: #RE21742 (Sub for #AA4039R)		

John Deere 5020

B2028-123	Negative Battery Cable	\$57.25
Replaces: #AR47005		
B2028-124	Positive Battery Cable	\$50.75
Replaces: #AR47004		

***For All Battery Cables, we can add Original Type Steel Armor for an additional cost of \$20.00.**



WIRING HARNESSSES

Our Wire Harnesses are made with our **premium cotton braid and/or PVC wire**.

They have the **correct gauge, color, wire, & fuse holders** (if needed).

All terminals are **soldered according to the original**.

(Harnesses do not include Battery Cables & Spark Plug Wires; however, we can supply these as separate products.)

NO HIDDEN COSTS, NOTHING EXTRA TO BUY!

John Deere A (Up to Serial #583,999)

Complete Wire Harness

B3028-001	Original Design with Generator and Cutout Relay	Replaces John Deere: #AB1964R Wiring Harness Starter Switch To Magnetic Switch; #AB1979R Wiring Harness Generator Wiring; #AA3298R Wiring Harness; #AB1963R Wiring Harness Rear Lamp; #AB1965R Wiring Harness Ammeter To Magnetic Switch; #AB1978R Wiring Harness Ammeter To Battery; #AA4845R Wiring Harness Ammeter To Starting Switch; #AF701R Lead With Fuse Ammeter To Light Switch	\$138.00
B3028-183	Modified for Generator & Replacement Voltage Regulator	See #B3028-001	\$138.00
B3028-224	Modified for 1 Wire Alternator	See #B3028-001	\$138.00

John Deere A (Serial #584,000 & Up)

Complete Wire Harness

B3028-002	Original Design with Generator	Replaces John Deere: #AA5695R Wiring Replacement Set; #AB4484R Wiring Harness Generator Wiring; #AA3975R Wiring Harness Side Lamp; #AA4051R Wiring Harness Light Switch To Rear Lamp; #AA4845R Wire Magnetic Switch To Starter Switch; #AB3547R Wiring Harness Starting Switch To Ammeter	\$138.00
B3028-225	Modified for 1 Wire Alternator	See #B3028-002	\$138.00
B3028-226	Modified for 10SI Alternator (3 Wire Alternator) / (Must be used with distributor Ignition)	See #B3028-002	\$138.00

John Deere AO (Serial #250,000 to 271,999) with Ring Terminal-Connected Lights

Complete Wire Harness

B3028-003	Original Design with Generator	Replaces John Deere: #AB1979R Wiring Harness Generator Wiring; #AB1962R Wiring Harness; #AB1963R Wiring Harness Rear Lamp; #AB1964R Wiring Starter Switch To Magnetic Switch; #AB1965R Wiring Harness Ammeter To Magnetic Switch; #AB1978R Wiring Harness Ammeter To Battery; #AA4845R Wiring Harness Ammeter To Starting Switch	\$146.25
B3028-360	Modified for Generator & Replacement Voltage Regulator	See #B3028-003	\$146.25

John Deere AO & AR (Serial #250,000 to 271,999) with 7" Twist Lock Terminal-Connected Lights

B3028-433	Complete Wire Harness, Original Design with Generator	See B3028-003	\$159.75
------------------	---	---------------	-----------------

John Deere AO (Serial #272,000 & Up)

B3028-004	Complete Wire Harness, Original Design with Generator		\$143.25
------------------	---	--	-----------------

John Deere AR (Serial #250,000 to 271,999) with Ring Terminal-Connected Lights

Complete Wire Harness

B3028-003	Original Design with Generator	Replaces John Deere: #AB1979R Wiring Harness Generator Wiring; #AB1962R Wiring Harness; #AB1963R Wiring Harness Rear Lamp; #AB1964R Wiring Starter Switch To Magnetic Switch; #AB1965R Wiring Harness Ammeter To Magnetic Switch; #AB1978R Wiring Harness Ammeter To Battery; #AA4845R Wiring Harness Ammeter To Starting Switch	\$146.25
B3028-360	Modified for Generator & Replacement Voltage Regulator	See #B3028-003	\$146.25

John Deere AR (Serial #272,000 & Up)

B3028-006	Complete Wire Harness Original Design with Generator		\$143.25
------------------	--	--	-----------------

John Deere B (Serial #60,000 to 95,999) with 7" Twist Lock Terminal-Connected Lights

B3028-426	Complete Wire Harness Original Design with Generator	See #B3028-007 below	\$151.50
------------------	--	----------------------	-----------------

John Deere B (Up to Serial #200,999) with Ring Terminal-Connected Lights

Complete Wire Harness

B3028-007	Original Design with Generator & Cutout Relay	Replaces John Deere: #AB1979R Wiring Harness Generator Wiring; #AB1962R Wiring Harness; #AB1963R Wiring Harness Rear Lamp; #AB1964R Wiring Starter Switch To Magnetic Switch; #AB1965R Wiring Harness Ammeter To Magnetic Switch; #AB1978R Wiring Harness Ammeter To Battery; #AA4845R Wiring Harness Ammeter To Starting Switch	\$138.00
B3028-380	Modified for Voltage Regulator	See #B3028-007	\$138.00
B3028-227	Modified for 1 Wire Alternator	See #B3028-007	\$138.00

John Deere B (Serial #201,000 & Up)

Complete Wire Harness

B3028-008	Original Design with Generator	Replaces John Deere: #AB4296R Wiring Replacement Set; #AA3975R Wiring Harness Side Lamp; #AA4051R Wiring Harness Light Switch To Rear Lamp; #AB3547R Wiring Harness Starter Switch To Ammeter; #AB4484R Wiring Harness Generator; #AA4845R Wiring Harness Ammeter To Starting Switch	\$138.00
B3028-213	Modified for 1 Wire Alternator	See #B3028-008	\$138.00
B3028-214	Modified for 10SI Alternator (3 Wire Alternator)	See #B3028-008	\$138.00

John Deere BO & BR with 7" Twist Lock Terminal-Connected Lights

B3028-433	Complete Wire Harness Original Design with Generator	See B3028-003	\$159.75
------------------	--	---------------	-----------------

John Deere BO & BR with Ring Terminal-Connected Lights

Complete Wire Harness

B3028-003	Original Design with Generator	Replaces John Deere: #AB1979R Wiring Harness Generator Wiring; #AB1962R Wiring Harness; #AB1963R Wiring Harness Rear Lamp; #AB1964R Wiring Starter Switch To Magnetic Switch; #AB1965R Wiring Harness Ammeter To Magnetic Switch; #AB1978R Wiring Harness Ammeter To Battery; #AA4845R Wiring Harness Ammeter To Starting Switch	\$146.25
B3028-360	Modified for Generator & Replacement Voltage Regulator	See #B3028-003	\$146.25

John Deere D (Serial #143,800 to 186,751)

B3028-011	Complete Wire Harness Original Design with Generator	Replaces John Deere: #AF701R Lead with Fuse Ammeter To Light Switch; #AD2057R Wiring Harness Generator; #AB1965R Lead Battery To Ammeter	\$159.75
------------------	--	---	-----------------

John Deere D (Serial #186,752 & Up)

B3028-012	Complete Wire Harness Original Design with Generator	Replaces John Deere: #AF701R Lead with Fuse Ammeter To Light Switch; #AD2704R Wiring Harness Generator; #AB1965R Lead Battery To Ammeter	\$159.75
------------------	--	---	-----------------

John Deere G & GM (Serial #13,000 to 25,999)

Complete Wire Harness

B3028-013	Original Design with Generator & Starter	Replaces John Deere: #AF701R Lead with Fuse Ammeter To Light Switch; #AF1005R Wiring Harness; #AD2094R Wiring Harness Generator; #AB1978R Lead Battery To Ammeter	\$138.00
B3028-311	Original Design with Generator & No Starter	Replaces John Deere: #AF1005R Wiring Harness; #AD2094R Wiring Harness Generator; #AB1978R Lead Battery To Ammeter	\$138.00
B3028-409	Modified for 1-Wire Alternator	See #B3028-013	\$138.00

John Deere G (Serial #26,000 & Up)

Complete Wire Harness

B3028-014	Original Design with Generator (Has Starter)	Replaces John Deere: #AF1326 Wiring Replacement Set; #AA4485R Lead Ignition Switch To Coil; #AA4881R Lead Ignition Coil To Distributor; #AA4882R Cable Ignition Secondary To Coil To Distributor; #AB1965R Lead Ammeter To Starting Motor; #AB4484R Wiring Harness Generator; #AB4484R Wiring Harness Lamp	\$138.00
B3028-394	Modified for 1 Wire Alternator(Has Starter)	See #B3028-014	\$138.00
B3028-395	Modified for 10SI Alternator (3 Wire Alternator) (Has Starter)	See #B3028-014 Note: Must be used with Battery Ignition	\$138.00

John Deere H

B3028-016	Complete Wire Harness Original Design with Generator	Replaces John Deere: #AF701R Lead with Fuse Ammeter To Light Switch; #AH976R Wiring Lead; #AH973R Wiring Harness Generator; #AA4442R Wiring Lead; #AH972R Wiring Cable Lighting	\$112.25
------------------	--	--	-----------------

John Deere L, LA

Complete Wire Harness

B3028-017	Original Design with Generator	Replaces John Deere: #AL2793T Lead with Fuse Ammeter To Light Switch; #AL2792T Wiring Harness Generator To Ammeter To Switch; #AL2924T Lead Ammeter To Battery; #AL2795T Lead Headlight To Switch; #AL2796T Lead Spotlight To Switch	\$76.25
B3028-420	Modified for 1 Wire Alternator	See #B3028-017	\$76.25

John Deere LI

B3028-019	Complete Wire Harness Original Design with Generator	Replaces John Deere: #AL2793T Lead with Fuse Ammeter To Light Switch; #AL2792T Wiring Harness Generator To Ammeter To Switch; #AL2924T Lead Ammeter To Battery; #AL2795T Lead Headlight To Switch (2 Used); #AL2796T Lead Spotlight To Switch (2 Used)	\$90.75
------------------	--	---	----------------

John Deere M, MC, MI, MT

Complete Wire Harness

B3028-020	Original Design with Generator & Cutout Relay	Replaces John Deere: #AM393T Lead with Fuse Ammeter To Light Switch; #AM355T Lead Ammeter To Cutout Relay; #AL2974T Lead Rear Light To Extension Lead; #AL2973T Lead Wiring Harness Extension; #AM356T Wiring Harness; #AL2971T Lead Front Lights; #AA3240R Lead	\$193.75
B3028-237	Modified for Generator & Voltage Regulator	See #B3028-020	\$193.75
B3028-238	Modified for 1 Wire Alternator	See #B3028-020	\$193.75
B3028-239	Modified for 10SI Alternator (3 Wire Alternator)	See #B3028-020	\$193.75

John Deere R

B3028-024	Complete Wire Harness Original Design with Generator	Replaces John Deere: #AR1012R Wiring Replacement Set; #AB1965R Lead Ammeter To Starting Motor Switch/Terminal; #AR494R Wiring Harness Generator; #AR495R Wiring Harness Lamp	\$173.00
------------------	--	---	-----------------

John Deere 40 Series

Complete Wire Harness

B3028-025	Original Design with Generator Fits John Deere Tractors: 40H, 40S, 40T, 40U, 40V, 40W	Replaces John Deere: #AA3240R Lead Bulb Contact To Terminal Post; #AL2971T Lead Harness To Lamp (2 Used); #AM2099T Lead Harness To Left Lamp; #AM1865T Wiring Harness; #AB4725R Wiring Assembly; #AM393T Lead Voltage Regulator To Switch; #AM355T Lead Voltage Regulator To Ammeter	\$200.75
B3028-230	Modified for 1 Wire Alternator	See #B3028-025	\$200.75
B3028-410	Modified for 10SI Alternator (3 Wire Alternator)	See #B3028-025	\$200.75

John Deere 40 Crawler

B3028-310	Complete Wire Harness Original Design with Generator Fits John Deere Tractors: 40H, 40S, 40T, 40U, 40V, 40W	Replaces John Deere: #AA3240R Lead Bulb Contact To Terminal Post; #AL2971T Lead Harness To Lamp (2 Used); #AM2099T Lead Harness To Left Lamp; #AM1865T Wiring Harness; #AB4725R Wiring Assembly; #AM393T Lead Voltage Regulator To Switch; #AM355T Lead Voltage Regulator To Ammeter	\$200.75
B3028-418	Rear Lighting Harness		\$46.25

John Deere 50 (Up to Serial #5,016,057)

Complete Wire Harness

B3028-026	Original Design with Generator		\$156.50
B3028-434	Modified for 1 Wire Alternator		\$156.50
B3028-321	Modified for 10SI Alternator (3 Wire Alternator)		\$156.50

John Deere 50 (Serial #5,016,058 to 5,021,479)

Complete Wire Harness

B3028-027	Original Design with Generator		\$156.50
B3028-436	Modified for 1 Wire Alternator		\$156.50

John Deere 50 (Serial #5,021,480 & Up)

Complete Wire Harness

B3028-028	Original Design with Generator		\$156.50
B3028-240	Modified for 1 Wire Alternator		\$156.50

John Deere 50 LP

Complete Wire Harness

B3028-029	Original Design with Generator		\$169.00
B3028-369	Modified for 1 Wire Alternator		\$169.00

John Deere 60 Row Crop (Up to Serial #6,017,060)

Complete Wire Harness

B3028-030	Original Design with Generator		\$156.50
B3028-362	Modified for 1 Wire Alternator		\$156.50

John Deere 60 Row Crop (Serial #6,017,061 to 6,029,999)

Complete Wire Harness

B3028-031	Original Design with Generator		\$143.25
B3028-406	Modified for 1 Wire Alternator		\$143.25

John Deere 60 Row Crop (Serial #6,030,000 & Up)

Complete Wire Harness

B3028-032	Original Design with Generator		\$156.50
B3028-438	Modified for 1 Wire Alternator		\$156.50
B3028-363	Modified for 10SI Alternator (3 Wire Alternator)		\$156.50

John Deere 60 LP

Complete Wire Harness

B3028-446	Original Design with Generator		\$169.00
B3028-447	Modified for 1 Wire Alternator		\$169.00

John Deere 60 Orchard

Complete Wire Harness

B3028-034	Original Design with Generator		\$196.75
------------------	--------------------------------	--	-----------------

John Deere 60 Standard (Up to Serial #6,042,999)

Complete Wire Harness

B3028-035	Original Design with Generator		\$149.25
------------------	--------------------------------	--	-----------------

John Deere 60 Standard (Serial #6,043,000 & Up)

B3028-036	Complete Wire Harness Original Design with Generator		\$163.75
------------------	---	--	-----------------

John Deere 70 Gas Row Crop

Complete Wire Harness

B3028-037	Original Design with Generator		\$156.50
B3028-241	Modified for 1 Wire Alternator		\$156.50
B3028-242	Modified for 10SI Alternator (3 Wire Alternator)		\$156.50

John Deere 70 Gas Standard

B3028-038	Complete Wire Harness, Original Design with Generator		\$163.75
------------------	---	--	-----------------

John Deere 70 LP Row Crop

Complete Wire Harness

B3028-041	Original Design with Generator		\$169.00
B3028-405	Modified for 1 Wire Alternator		\$169.00

John Deere 70 LP Standard

B3028-042	Complete Wire Harness, Original Design with Generator		\$177.25
------------------	---	--	-----------------

John Deere 70 Diesel Row Crop

Complete Wire Harness

B3028-039	Original Design with Generator		\$183.25
B3028-364	Modified for 12 Volt 1 Wire Alternator & Electric Start	Note: Fuel Gauge will not work when tractor is running	\$183.25

John Deere 70 Diesel Standard

Complete Wire Harness

B3028-040	Original Design with Generator		\$189.50
B3028-374	Modified for 12 Volt 1 Wire Alternator & Electric Start	Note: Fuel Gauge will not work when tractor is running	\$189.50

John Deere 80

B3028-043	Complete Wire Harness, Original Design with Generator	<u>Replaces:</u> #AR1423R Complete Wire Harness	\$183.25
------------------	---	---	-----------------

John Deere 125 Diesel Skid Steer (Serial #120,001-220,000)

B3028-044	Complete Wire Harness Original Design	<u>Replaces John Deere:</u> #GG420-33923 Wiring Lead; #GG420-33944 Wiring Harness Generator; #GG420-33167 Wiring Harness Lamp	\$249.25
------------------	--	---	-----------------

John Deere 320 Gas Farm Tractor

Complete Wire Harness

B3028-045	Original Design with Generator	<u>Replaces John Deere:</u> #AM1865T Wiring Harness; #AB4725R Wiring Assembly Dash Lamp; #AM2050T Wiring Harness Rear	\$196.75
B3028-231	Modified for 1 Wire Alternator	See #B3028-045	\$196.75
B3028-232	Modified for 10SI Alternator (3 Wire Alternator)	See #B3028-045	\$196.75
B3028-455	Light Switch to Rear Work Light Only	<u>Replaces:</u> #AM2050T Wiring Harness Rear	\$45.00

John Deere 320 LP Farm Tractor

Complete Wire Harness

B3028-046	Original Design with Generator		\$203.00
B3028-425	Modified for 1 Wire Alternator		\$203.00

John Deere 330 Gas Farm Tractor

Complete Wire Harness

B3028-047	Original Design with Generator	<u>Replaces John Deere:</u> #AM10769T Wiring Harness; #AB4725R Wiring Assembly Dash Lamp; #AM10799T Wiring Harness Rear	\$203.00
B3028-229	Modified for 1 Wire Alternator	See #B3028-047	\$203.00
B3028-228	Modified for 10SI Alternator (3 Wire Alternator)	See #B3028-047	\$203.00

John Deere 330 LP Farm Tractor

B3028-048	Complete Wire Harness, Original Design with Generator		\$210.00
------------------	---	--	-----------------

John Deere 330 Crawler Farm Tractor

Complete Wire Harness

B3028-371	Original Design with Generator	<u>Replaces John Deere:</u> #AM10769T Wiring Harness; #AB4725R Wiring Assembly Dash Lamp; #AM2038T Wiring Harness Rear	\$203.00
B3028-372	Modified for 1 Wire Alternator	See #B3028-371	\$203.00
B3028-373	Modified for 10SI Alternator (3 Wire Alternator)	See #B3028-371	\$203.00

John Deere 420 Gas Farm Tractor

Complete Wire Harness

B3028-045	Original Design with Generator	Replaces John Deere: #AB4725R Wiring Assembly Dash Lamp; #AM355T Wiring Lead Voltage Regulator To Ammeter; #AM1865T Wiring Harness	\$196.75
B3028-231	Modified for 1 Wire Alternator	See #B3028-045	\$196.75
B3028-232	Modified for 10SI Alternator (3 Wire Alternator)	See #B3028-045	\$196.75
B3028-455	Light Switch to Rear Work Light Only	Replaces: #AM2050T Wiring Harness Rear	\$45.00

John Deere 320, 420 Crawler Farm Tractor

Complete Wire Harness

B3028-218	Original Design with Generator	Replaces John Deere: #AB4725R Wiring Assembly Dash Lamp; #AM355T Wiring Lead Voltage Regulator To Ammeter; #AM1865T Wiring Harness; #AM2038T Wiring Harness Rear	\$196.75
B3028-309	Modified for a ND Alternator (Small 2 Wire Alternator)	See #B3028-218	\$196.75
B3028-429	Modified for 10SI Alternator (3 Wire Alternator)	See #B3028-218	\$196.75

John Deere 420 LP Farm Tractor

Complete Wire Harness

B3028-046	Original Design with Generator	Replaces John Deere: #AB4725R Wiring Assembly Dash Lamp; #AM355T Wiring Lead Voltage Regulator To Ammeter; #AM1865T Wiring Harness	\$203.00
B3028-425	Modified for 1 Wire Alternator	See #B3028-046 above	\$203.00

John Deere 430 Gas Farm Tractor

Complete Wire Harness

B3028-047	Original Design with Generator	Replaces John Deere: #AB4725R Wiring Assembly Dash Lamp; #AM10874T Wiring Lead Voltage Regulator To Ammeter; #AM10769T Wiring Harness	\$203.00
B3028-229	Modified for 1 Wire Alternator	See #B3028-047 above	\$203.00
B3028-228	Modified for 10SI Alternator (3 Wire Alternator)	See #B3028-047 above	\$203.00

John Deere 430 LP Farm Tractor

B3028-048	Complete Wire Harness Original Design with Generator	Replaces John Deere: #AB4725R Wiring Assembly Dash Lamp; #AM355T Wiring Lead Voltage Regulator To Ammeter; #AM1865T Wiring Harness	\$210.00
------------------	--	---	-----------------

John Deere 430 Crawler Farm Tractor

Complete Wire Harness

B3028-371	Original Design with Generator	Replaces John Deere: #AM10769T Wiring Harness; #AB4725R Wiring Assembly Dash Lamp; #AM2038T Wiring Harness Rear	\$203.00
B3028-372	Modified for 1 Wire Alternator	See #B3028-371 above	\$203.00
B3028-373	Modified for 10SI Alternator (3 Wire Alternator)	See #B3028-371 above	\$203.00

John Deere 435 Diesel Tractor

Complete Wire Harness

B3028-054	Original Design with Generator	Replaces John Deere: #AM11282T Front Harness, #AT10484T Rear Harness, #AB4725R Dash Lamp Lead, #AM3120T Fuse Holder & Lead Wires	\$223.50
B3028-358	Modified for 1 Wire Alternator	See #B3028-054 above	\$223.50

John Deere 435 & 440 Diesel Crawler

Complete Wire Harness

B3028-414	Original Design with Generator	Replaces John Deere: #AM11282T Front Harness, #AT10483T, #AL2976T Rear Harness, #AB4725R Dash Lamp Lead, #AM3120T Fuse Holder & Lead Wires	\$223.50
B3028-415	Modified for 1 Wire Alternator	See #B3028-414 above	\$223.50

Includes Listed Components Below and Can Be Purchased Separately

B3028-413	Rear Light Lead for Crawler only	Replaces John Deere: #AT10483T, #AL2976T	\$38.00
------------------	----------------------------------	---	----------------

John Deere 440 Gas

B3028-056	Complete Wire Harness Original Design with Generator	Replaces John Deere: #AM10191T Front Harness, #AT10731T Rear Harness, #AB4725R Dash Lamp Lead, #AM3120T Fuse Holder & Lead Wires	\$203.00
------------------	--	---	-----------------

John Deere 440 Gas Crawler

Complete Wire Harness

B3028-368	Original Design with Generator	Replaces John Deere: #AM10191T Front Harness, #AM2038T Wiring Harness Rear, #AB4725R Dash Lamp Lead, #AM3120T Fuse Holder & Lead Wires	\$203.00
B3028-435	Modified for 1 Wire Alternator	See #B3028-368 above	\$203.00

John Deere 440 Diesel

Complete Wire Harness

B3028-054	Original Design with Generator	Replaces John Deere: #AM11282T Front Harness, #AT10484T Rear Harness, #AB4725R Dash Lamp Lead, #AM3120T Fuse Holder & Lead Wires	\$223.50
B3028-358	Modified for 1 Wire Alternator	See #B3028-054	\$223.50

John Deere 520 Gas Row Crop

Complete Wire Harness

B3028-057	Original Design with Generator	Replaces John Deere: #AB5298R Complete Harness, AA4881R, AA4882R, AA5652R, AF3814R, AA6037R, AA6491R, AA6503R, AF3813R, AB4795R, AF2639R	\$196.75
B3028-184	Modified for 1 Wire Alternator	See #B3028-057	\$196.75
B3028-326	Modified for 10SI Alternator (3 Wire Alternator)	See #B3028-057	\$196.75

John Deere 520 LP Row Crop

Complete Wire Harness

B3028-164	Original Design with Generator	Replaces John Deere: #AB5299R Complete Harness, AA4881R, AA4882R, AA5652R, AF3814R, AA6037R, AA6503R, AF3813R, AB4795R, AF2639R, AF2675R	\$210.00
B3028-234	Modified for 1 Wire Alternator	See #B3028-164	\$210.00

John Deere 530 Gas with 4-Light Flat Fender Lighting

Complete Wire Harness

B3028-060	Original Design with Generator	Replaces John Deere: #AR21115R	\$229.75
B3028-252	Modified for 1 Wire Alternator		\$229.75
B3028-348	Modified for 10SI Alternator (3 Wire Alternator)		\$229.75

Includes Listed Components Below and Can Be Purchased Separately

Engine, Dash, & Rear Light Harness (does not include Front Lighting)

B3028-120	Original Design with Generator	Replaces John Deere: #AA4881R, #AA4882R, #AA5673R, #AF3814R, #AR20708R, #AR20710R, #AR20713R, #AR20714R, #AR20715R	\$163.75
B3028-250	Modified for 1 Wire Alternator	See #B3028-120	\$163.75
B3028-342	Modified for 10SI Alternator (3 Wire Alternator)	See #B3028-120	\$163.75
B3028-088	Fender Lighting & Dash Harness	Replaces John Deere: #AR20724R	\$103.00
B3028-449	Switch-to-Rear Light Harness	Replaces John Deere – #AA5652R, AF2124R, AF3814R, AF3815R	\$29.75

John Deere 530 Gas with Cowl Mounted Lights

Complete Wire Harness

B3028-058	Original Design with Generator	Replaces John Deere: #AR21114R	\$196.75
B3028-251	Modified for 1 Wire Alternator		\$196.75
B3028-345	Modified for 10SI Alternator (3 Wire Alternator)		\$196.75

Includes Listed Components Below and Can Be Purchased Separately

Engine, Dash, & Rear Light Harness (does not include Front Lighting)

B3028-120	Original Design with Generator	Replaces John Deere: #AA4881R, #AA4882R, #AA5673R, #AF3814R, #AR20708R, #AR20710R, #AR20713R, #AR20714R, #AR20715R	\$163.75
B3028-250	Modified for 1 Wire Alternator	See #B3028-120	\$163.75
B3028-342	Modified for 10SI Alternator (3 Wire Alternator)	See #B3028-120	\$163.75
B3028-123	Lighting & Dash Harness	Replaces John Deere: #AR20719R	\$35.00
B3028-449	Switch-to-Rear Light Harness	Replaces John Deere – #AA5652R, AF2124R, AF3814R, AF3815R	\$29.75

John Deere 530 LP with Cowl-Mounted Lights

Complete Wire Harness

B3028-059	Original Design with Generator	Replaces John Deere: #AR21117R	\$196.75
B3028-258	Modified for 1 Wire Alternator		\$196.75

Includes Listed Components Below and Can Be Purchased Separately

Engine, Dash, & Rear Light Harness (does not include Front Lighting)

B3028-125	Original Design with Generator	Replaces John Deere: #AA4881R, #AA4882R, #AA5673R, #AF3814R, #AR20708R, #AR20710R, #AR20713R, #AR20714R, #AR20715R	\$163.75
B3028-257	Modified for 1 Wire Alternator	See #B3028-125	\$163.75
B3028-123	Lighting & Dash Harness	Replaces John Deere: #AR20719R	\$35.00

John Deere 530 LP With 4-Light Flat Fender Lighting

Complete Wire Harness

B3028-196	Original Design with Generator	Replaces John Deere: #AR21118R	\$212.25
B3028-259	Modified for 1 Wire Alternator		\$212.25

Includes Listed Components Below and Can Be Purchased Separately

Engine, Dash, & Rear Light Harness (does not include Front Lighting)

B3028-125	Original Design with Generator	Replaces John Deere: #AA4881R, #AA4882R, #AA5673R, #AF3814R, #AR20708R, #AR20710R, #AR20713R, #AR20714R, #AR20715R	\$163.75
B3028-257	Modified for 1 Wire Alternator	See #B3028-125	\$163.75
B3028-088	Fender Lighting & Dash Harness	Replaces John Deere: #AR20724R	\$103.00

John Deere 620 Gas Row Crop

Complete Wire Harness

B3028-062	Original Design with Generator	Replaces John Deere #AA6826R, AA7350R Complete Harness, AA4881R, AA4882R, AA5652R, AA5739R, AA6045R, AA6046R, AA6491R, AA6503R, AF2639R, AF3813R, AF3814R	\$196.75
B3028-185	Modified for 1 Wire Alternator	See #B3028-062	\$196.75
B3028-324	Modified for 10SI Alternator (3 Wire Alternator)	See #B3028-062	\$196.75

John Deere 620 Gas Standard

Complete Wire Harness

B3028-160	Original Design with Generator	Replaces John Deere: #AA6827R, AA7351R Complete Harness, AA4881R, AA4882R, AA5652R, AA5739R, AA6045R, AA6046R, AA6491R, AA6503R, AF2676R, AF3813R, AF3814R	\$203.00
B3028-244	Modified for 1 Wire Alternator	See #B3028-160	\$203.00

John Deere 620 LP Row Crop

Complete Wire Harness

B3028-063	Original Design with Generator	Replaces John Deere: #AA6828R, AA7352R Complete Harness, AA4881R, AA4882R, AA5652R, AA5739R, AA6045R, AA6046R, AA6491R, AA6503R, AF2639R, AF2675R, AF3813R, AF3814R	\$210.00
B3028-233	Modified for 1 Wire Alternator	See #B3028-063	\$210.00

John Deere 620 LP Standard

B3028-437	Complete Wire Harness Original Design with Generator	Replaces John Deere: #AF3330R Complete Harness, AA4881R, AA4882R, AF1393R, AF2639R, AF2675R, AF2825R, AF3813R, AF3814R	\$223.50
------------------	--	---	-----------------

John Deere 620 Orchard (Up to Serial #6,222,999)

B3028-034	Complete Wire Harness Original Design with Generator	Replaces John Deere: #AA7215R Complete Harness, AA4442R, AA4881R, AA4882R, AA5739R, AA6037R, AA6045R, AA6046R, AA6491R, AA6567R, AA7091R, AA7226R, AF3814R	\$196.75
------------------	--	---	-----------------

John Deere 620 Gas Orchard (Serial #6,223,000 & Up)

B3028-065	Complete Wire Harness Original Design with Generator	Replaces John Deere: #AR21269R Complete Harness, AA4442R, AA4881R, AA4882R, AA5739R, AA6037R, AA6491R, AA6567R, AA7091R, AA7226R, AF3814R, AR21250R, AR21251R	\$210.00
------------------	--	--	-----------------

John Deere 620 LP Orchard (Up to Serial #6,222,999)

B3028-066	Complete Wire Harness Original Design with Generator	Replaces John Deere: #AA7216R Complete Harness, AA4442R, AA4881R, AA4882R, AA6037R, AA6045R, AA6046R, AA6491R, AA7091R, AA7226R, AF1393R, AF3814R	\$223.50
------------------	--	--	-----------------

John Deere 620 LP Orchard (Serial #6,223,000 & Up)

B3028-067	Complete Wire Harness Original Design with Generator	Replaces John Deere: #AR21270R Complete Harness, AA4442R, AA4881R, AA4882R, AA6037R, AA6045R, AA6046R, AA6491R, AA6567R, AA7091R, AA7226R, AF3814R	\$223.50
------------------	--	---	-----------------

John Deere 630 Gas with 4-Light Flat Fender Lighting

Complete Wire Harness

B3028-070	Original Design with Generator	Replaces John Deere: #AR21115R	\$229.75
B3028-254	Modified for 1 Wire Alternator		\$229.75
B3028-349	Modified for 10SI Alternator (3 Wire Alternator)		\$229.75

Includes Listed Components Below and Can Be Purchased Separately

Engine, Dash, & Rear Light Harness (does not include Front Lighting)

B3028-121	Original Design with Generator	Replaces John Deere: #AA4881R, #AA4882R, #AA5673R, #AF3814R, #AR20708R, #AR20710R, #AR20713R, #AR20714R, #AR20715R	\$163.75
B3028-256	Modified for 1 Wire Alternator	See #B3028-121	\$163.75
B3028-343	Modified for 10SI Alternator (3 Wire Alternator)	See #B3028-121	\$163.75
B3028-088	Fender Lighting & Dash Harness	Replaces John Deere: #AR20724R	\$103.00
B3028-449	Switch-to-Rear Light Harness	Replaces John Deere – #AA5652R, AF2124R, AF3814R, AF3815R	\$29.75

John Deere 630 Gas with Cowl Mounted Lights

Complete Wire Harness

B3028-068	Original Design with Generator	Replaces John Deere: #AR21114R	\$196.75
B3028-253	Modified for 1 Wire Alternator		\$196.75
B3028-346	Modified for 10SI Alternator (3 Wire Alternator)		\$196.75

Includes Listed Components Below and Can Be Purchased Separately

Engine, Dash, & Rear Light Harness (does not include Front Lighting)

B3028-121	Original Design with Generator	Replaces John Deere: #AA4881R, #AA4882R, #AA5673R, #AF3814R, #AR20708R, #AR20710R, #AR20713R, #AR20714R, #AR20715R	\$163.75
B3028-256	Modified for 1 Wire Alternator	See #B3028-121	\$163.75
B3028-343	Modified for 10SI Alternator (3 Wire Alternator)	See #B3028-121	\$163.75
B3028-123	Lighting & Dash Harness	Replaces John Deere: #AR20719R	\$35.00
B3028-449	Switch-to-Rear Light Harness	Replaces John Deere – #AA5652R, AF2124R, AF3814R, AF3815R	\$29.75

John Deere 630 Gas Standard with Clamshell Fender Lighting

Complete Wire Harness

B3028-129	Original Design with Generator	Replaces John Deere: #AR2119R	\$203.00
B3028-255	Modified for 1 Wire Alternator		\$203.00
B3028-351	Modified for 10SI Alternator (3 Wire Alternator)		\$203.00

Includes Listed Components Below and Can Be Purchased Separately

Engine, Dash, & Rear Light Harness (does not include Front Lighting)

B3028-121	Original Design with Generator	Replaces John Deere: #AA4881R, #AA4882R, #AA5673R, #AF3814R, #AR20708R, #AR20710R, #AR20713R, #AR20714R, #AR20715R	\$163.75
B3028-256	Modified for 1 Wire Alternator	See #B3028-121	\$163.75
B3028-343	Modified for 10SI Alternator (3 Wire Alternator)	See #B3028-121	\$163.75
B3028-124	Lighting & Dash Harness	Replaces John Deere: #AR20720R	\$49.50

John Deere 630 LP with Cowl Mounted Lights

Complete Wire Harness

B3028-069	Original Design with Generator	Replaces John Deere: #AR21117R	\$196.75
B3028-261	Modified for 1 Wire Alternator		\$196.75

Includes Listed Components Below and Can Be Purchased Separately

Engine, Dash, & Rear Light Harness (does not include Front Lighting)

B3028-126	Original Design with Generator	Replaces John Deere: #AA4881R, #AA4882R, #AA5673R, #AF3814R, #AR20708R, #AR20710R, #AR20713R, #AR20714R, #AR20715R	\$163.75
------------------	--------------------------------	---	-----------------

B3028-260	Modified for 1 Wire Alternator	See #B3028-126	\$163.75
B3028-123	Lighting & Dash Harness	Replaces John Deere: #AR20719R	\$35.00

John Deere 630 LP Standard with Clamshell Fender Lighting

Complete Wire Harness

B3028-132	Original Design with Generator	Replaces John Deere: #AR21121R	\$203.00
B3028-262	Modified for 1 Wire Alternator		\$203.00

Includes Listed Components Below and Can Be Purchased Separately

Engine, Dash, & Rear Light Harness (does not include Front Lighting)

B3028-126	Original Design with Generator	Replaces John Deere: #AA4881R, #AA4882R, #AA5673R, #AF3814R, #AR20708R, #AR20710R, #AR20713R, #AR20714R, #AR20715R	\$163.75
B3028-260	Modified for 1 Wire Alternator	See #B3028-126	\$163.75
B3028-124	Lighting & Dash Harness	Replaces John Deere: #AR20720R	\$49.50

John Deere 630 LP with 4-Light Flat Fender Lighting

Complete Wire Harness

B3028-071	Original Design with Generator	Replaces John Deere: #AR21118R	\$229.75
B3028-263	Modified for 1 Wire Alternator		\$229.75

Includes Listed Components Below and Can Be Purchased Separately

Engine, Dash, & Rear Light Harness (does not include Front Lighting)

B3028-126	Original Design with Generator	Replaces John Deere: #AA4881R, #AA4882R, #AA5673R, #AF3814R, #AR20708R, #AR20710R, #AR20713R, #AR20714R, #AR20715R	\$163.75
B3028-260	Modified for 1 Wire Alternator	See #B3028-126	\$163.75
B3028-088	Fender Lighting & Dash Harness	Replaces John Deere: #AR20724R	\$103.00

John Deere 720 Gas Row Crop

Complete Wire Harness

B3028-072	Original Design with Generator	Replaces John Deere: #AF3327R Complete Harness, AA4881R, AA4882R, AF1393R, AF2639R, AF2675R, AF2825R, AF3813R, AF3814R	\$196.75
B3028-186	Modified for 1 Wire Alternator	See #B3028-072	\$196.75
B3028-325	Modified for 10SI Alternator (3 Wire Alternator)	See #B3028-072	\$196.75

John Deere 720 Gas Standard

Complete Wire Harness

B3028-162	Original Design with Generator	Replaces John Deere: #AF3328R Complete Harness, AA4881R, AA4882R, AF1393R, AF2639R, AF2675R, AF2825R, AF3813R, AF3814R	\$203.00
B3028-245	Modified for 1 Wire Alternator	See #B3028-162	\$203.00

John Deere 720 LP Row Crop

Complete Wire Harness

B3028-073	Original Design with Generator	Replaces John Deere: #AF3329R Complete Harness, AA4881R, AA4882R, AF1393R, AF2639R, AF2675R, AF2825R, AF3813R, AF3814R	\$203.00
B3028-235	Modified for 1 Wire Alternator	See #B3028-073	\$203.00

John Deere 720 LP Standard

B3028-236	Complete Wire Harness Original Design with Generator	Replaces John Deere: #AF3330R Complete Harness, AA4881R, AA4882R, AF1393R, AF2639R, AF2675R, AF2825R, AF3813R, AF3814R	\$223.50
------------------	---	---	-----------------

John Deere 720 Diesel Row Crop with Pony Start

B3028-074	Complete Wire Harness Original Design with Generator	Replaces John Deere: #AF3456 Wiring Replacement Harness, #AA5673R, AF2172R, AF2174R, AF2639R, AF2692R, AF2693R, AF3814R, AF3815R	\$210.00
------------------	---	---	-----------------

John Deere 720 Diesel Standard with Pony Start

B3028-207	Complete Wire Harness Original Design with Generator	Replaces John Deere: #AF3457 Wiring Replacement Harness, #AA5673R, AF2172R, AF2174R, AF2676R, AF2692R, AF2693R, AF3814R, AF3815R	\$217.25
------------------	---	---	-----------------

John Deere 720 Diesel Row Crop (Serial #7222600 & Up) with Electric Start

Complete Wire Harness

B3028-075	Original Design with Generator	Replaces John Deere: #AR20591R Complete Harness; #AA5673R, AF3814R, AR20218R, AR20241R, AR20242R, AR20713R, AR20721R, AR21961R, AR20715R	\$223.50
B3028-319	Modified for Use with a 12 Volt 10SI Alternator	*Note: May Be Used With A 1 Wire Alternator, Except The Charge Indicator Lamp Will Not Work!	\$223.50

John Deere 720 Diesel Standard (Serial #7222600 & Up) with Electric Start

Complete Wire Harness

B3028-163	Original Design with Generator	Replaces John Deere: #AR20592R Complete Harness; #AA5673R, AF3814R, AR20218R, AR20241R, AR20242R, AR20713R, AR20722R, AR21961R, AR20715R	\$238.00
B3028-320	Modified for Use with a 12 Volt 10SI Alternator	*Note: May Be Used With A 1 Wire Alternator, Except The Charge Indicator Lamp Will Not Work!	\$238.00

John Deere 730 Gas Row Crop with 4-Light Flat Fender Lighting

Complete Wire Harness

B3028-078	Original Design with Generator	Replaces John Deere: #AR21115R	\$229.75
B3028-176	Modified for 1 Wire Alternator		\$229.75
B3028-350	Modified for 10SI Alternator (3 Wire Alternator)		\$229.75

Includes Listed Components Below and Can Be Purchased Separately

Engine, Dash, & Rear Light Harness (does not include Front Lighting)

B3028-122	Original Design with Generator	Replaces John Deere: #AA4881R, #AA4882R, #AA5673R, #AF3814R, #AR20708R, #AR20710R, #AR20713R, #AR20714R, #AR20715R	\$163.75
B3028-177	Modified for 1 Wire Alternator	See #B3028-122	\$163.75
B3028-344	Modified for 10SI Alternator (3 Wire Alternator)	See #B3028-122	\$163.75

B3028-088	Fender Lighting & Dash Harness	Replaces John Deere: #AR20724R	\$103.00
------------------	---	---------------------------------------	-----------------

John Deere 730 Gas Row Crop with Cowl Mounted Lights

Complete Wire Harness

B3028-076	Original Design with Generator	Replaces John Deere: #AR21114R	\$196.75
B3028-246	Modified for 1 Wire Alternator		\$196.75
B3028-347	Modified for 10SI Alternator (3 Wire Alternator)		\$196.75

Includes Listed Components Below and Can Be Purchased Separately

Engine, Dash, & Rear Light Harness (does not include Front Lighting)

B3028-122	Original Design with Generator	Replaces John Deere: #AA4881R, #AA4882R, #AA5673R, #AF3814R, #AR20708R, #AR20710R, #AR20713R, #AR20714R, #AR20715R	\$163.75
B3028-177	Modified for 1 Wire Alternator	See #B3028-122	\$163.75
B3028-344	Modified for 10SI Alternator (3 Wire Alternator)	See #B3028-122	\$163.75

B3028-123	Lighting & Dash Harness	Replaces John Deere: #AR20719R	\$35.00
------------------	------------------------------------	---------------------------------------	----------------

B3028-449	Switch-to-Rear Light Harness	Replaces John Deere - #AA5652R, AF2124R, AF3814R, AF3815R	\$29.75
------------------	-------------------------------------	--	----------------

John Deere 730 Gas Standard with Clamshell Fender Lighting

Complete Wire Harness

B3028-130	Original Design with Generator	Replaces John Deere: #AR21116R	\$203.00
B3028-247	Modified for 1 Wire Alternator		\$203.00
B3028-352	Modified for 10SI Alternator (3 Wire Alternator)		\$203.00

Includes Listed Components Below and Can Be Purchased Separately

Engine, Dash, & Rear Light Harness (does not include Front Lighting)

B3028-122	Original Design with Generator	Replaces John Deere: #AA4881R, #AA4882R, #AA5673R, #AF3814R, #AR20708R, #AR20710R, #AR20713R, #AR20714R, #AR20715R	\$163.75
B3028-177	Modified for 1 Wire Alternator	See #B3028-122	\$163.75
B3028-344	Modified for 10SI Alternator (3 Wire Alternator)	See #B3028-122	\$163.75

B3028-124	Lighting & Dash Harness	Replaces John Deere: #AR20720R	\$49.50
------------------	------------------------------------	---------------------------------------	----------------

John Deere 730 LP Row Crop with Cowl Mounted Lights

Complete Wire Harness

B3028-077	Original Design with Generator	Replaces John Deere: #AR21119R	\$196.75
------------------	--------------------------------	---------------------------------------	-----------------

B3028-265	Modified for 1 Wire Alternator		\$196.75
------------------	--------------------------------	--	-----------------

Includes Listed Components Below and Can Be Purchased Separately

Engine/ Dash Harness (does not include Front Lights)

B3028-127	Original Design with Generator	Replaces John Deere: #AA4881R, #AA4882R, #AA5673R, #AF3814R, #AR20708R, #AR20710R, #AR20713R, #AR20714R, #AR20715R	\$163.75
B3028-264	Modified for 1 Wire Alternator	See #B3028-127	\$163.75
B3028-123	Lighting & Dash Harness	Replaces John Deere: #AR20719R	\$35.00

John Deere 730 LP Standard with Clamshell Fender Lighting

Complete Wire Harness

B3028-133	Original Design with Generator	Replaces John Deere: #AR21121R	\$203.00
B3028-266	Modified for 1 Wire Alternator		\$203.00

Includes Listed Components Below and Can Be Purchased Separately

Engine/ Dash Harness (does not include Front Lights)

B3028-127	Original Design with Generator	Replaces John Deere: #AA4881R, #AA4882R, #AA5673R, #AF3814R, #AR20708R, #AR20710R, #AR20713R, #AR20714R, #AR20715R	\$163.75
B3028-264	Modified for 1 Wire Alternator	See #B3028-127	\$163.75
B3028-124	Lighting & Dash Harness	Replaces John Deere: #AR20720R	\$49.50

John Deere 730 LP Row Crop with 4-Light Flat Fender Lighting

Complete Wire Harness

B3028-079	Original Design with Generator	Replaces John Deere: #AR21120R	\$229.75
B3028-267	Modified for 1 Wire Alternator		\$229.75

Includes Listed Components Below and Can Be Purchased Separately

Engine/ Dash Harness (does not include Front Lights)

B3028-127	Original Design with Generator	Replaces John Deere: #AA4881R, #AA4882R, #AA5673R, #AF3814R, #AR20708R, #AR20710R, #AR20713R, #AR20714R, #AR20715R	\$163.75
B3028-264	Modified for 1 Wire Alternator	See #B3028-127	\$163.75
B3028-088	Fender Lighting & Dash Harness	Replaces John Deere: #AR20724R	\$103.00

John Deere 730 Diesel Row Crop with Pony Start & 4-Light Flat Fender Lighting

B3028-081	Complete Wire Harness Original Design with Generator	Replaces John Deere: #AR21123R	\$244.00
------------------	---	---------------------------------------	-----------------

Includes Listed Components Below and Can Be Purchased Separately

B3028-134	Engine/ Dash Harness	Replaces John Deere: #AA5673R, #AF3814R, #AR20715R, #AR20716R	\$177.25
B3028-088	Fender Lighting & Dash Harness	Replaces John Deere: #AR20724R	\$103.00

John Deere 730 Diesel Row Crop with Pony Start & Cowl Mounted Lights

B3028-080	Complete Wire Harness Original Design with Generator	Replaces John Deere: #AR21122R	\$196.75
------------------	---	---------------------------------------	-----------------

Includes Listed Components Below and Can Be Purchased Separately

B3028-134	Engine/ Dash Harness	Replaces John Deere: #AA5673R, #AF3814R, #AR20715R, #AR20716R	\$177.25
B3028-123	Lighting & Dash Harness	Replaces John Deere: #AR20719R	\$35.00

John Deere 730 Diesel Standard with Pony Start & Clamshell Fender Lighting

B3028-135	Complete Wire Harness Original Design with Generator	Replaces John Deere: #AR21124R	\$217.25
------------------	---	---------------------------------------	-----------------

Includes Listed Components Below and Can Be Purchased Separately

B3028-134	Engine/ Dash Harness	Replaces John Deere: #AA5673R, #AF3814R, #AR20715R, #AR20716R	\$177.25
B3028-124	Lighting & Dash Harness	Replaces John Deere: #AR20720R	\$49.50

John Deere 730 Diesel Row Crop With Electric Start & 4-Light Flat Fender Lighting

Complete Wire Harness

B3028-083	Original Design with 24-Volt Generator	Replaces John Deere: #AR21126R	\$238.00
B3028-322	Modified for 10SI Alternator (12-Volt, 3-Wire Alternator)		\$238.00

Includes Listed Components Below and Can Be Purchased Separately

Engine, Dash, & Rear Light Harness (does not include Front Lighting)

B3028-144	Original Design with 24-Volt Generator	Replaces John Deere: #AA5673R, #AF3814R, #AR20715R, #AR20218R, #AR20721R	\$169.00
B3028-298	Modified for 10SI Alternator (12-Volt, 3-Wire Alternator)	See #B3028-144	\$169.00
B3028-088	Fender Lighting & Dash Harness	Replaces John Deere: #AR20724R	\$103.00
B3028-450	Charge Indicator Light Assembly	(included with Engine Harnesses above, except for the Jewel Light)	\$39.75

John Deere 730 Diesel Row Crop with Electric Start & Cowl Mounted Lights

Complete Wire Harness

B3028-082	Original Design with 24-Volt Generator	Replaces John Deere: #AR21125R	\$196.75
B3028-299	Modified for 10SI Alternator (12-Volt, 3-Wire Alternator)		\$196.75

Includes Listed Components Below and Can Be Purchased Separately

Engine, Dash, & Rear Light Harness (does not include Front Lighting)

B3028-144	Original Design with 24-Volt Generator	Replaces John Deere: #AA5673R, #AF3814R, #AR20715R, #AR20218R, #AR20721R	\$169.00
B3028-298	Modified for 10SI Alternator (12-Volt, 3-Wire Alternator)	See #B3028-144	\$169.00
B3028-136	Lighting & Dash Harness	Replaces John Deere: #AR20721R	\$42.25
B3028-450	Charge Indicator Light Assembly	(included with Engine Harnesses above, except for the Jewel Light)	\$39.75

John Deere 730 Diesel Standard with Electric Start & Clamshell Fender Lighting

B3028-138	Complete Wire Harness Original Design with 24-Volt Generator	Replaces John Deere: #AR21127R	\$210.00
------------------	--	---------------------------------------	-----------------

Includes Listed Components Below and Can Be Purchased Separately

B3028-144	Engine, Dash, & Rear Light Harness	Replaces: #AA5673R, #AF3814R, #AR20715R, (See Above)	\$169.00
B3028-137	Lighting & Dash Harness	Replaces John Deere: #AR20722R	\$55.50
B3028-450	Charge Indicator Light Assembly	(included with Engine Harness above, except for the Jewel Light)	\$39.75

John Deere 820 Diesel with Pony Start

For American Made 2-Cylinder Tractors Only. (Does Not Fit German Made 3-Cylinders.)

B3028-084	Complete Wire Harness Original Design with Generator	Replaces John Deere: #AR1581R	\$210.00
------------------	---	--------------------------------------	-----------------

John Deere 820 Diesel Modified for Electric Start

For American Made 2-Cylinder Tractors Only. (Does Not Fit German Made 3-Cylinders.)

B3028-085	Complete Wire Harness Original Design with Generator		\$217.25
------------------	---	--	-----------------

John Deere 830 Diesel with Pony Start

For American Made 2-Cylinder Tractors Only. (Does Not Fit German Made 3-Cylinders.)

Complete Wire Harness

B3028-086	Original Design with Generator	Replaces John Deere: #AR21317R Complete Wire Harness	\$210.00
B3028-448	Modified for a 1-Wire Alternator, allows for use of the "S" Terminal	(see B3028-086 above)	\$210.00

John Deere 830 Diesel with Electric Start Original Design With Generator.

For American Made 2-Cylinder Tractors Only. (Does Not Fit German Made 3-Cylinders.)

B3028-087	Complete Wire Harness Original Design with Generator	Replaces John Deere: #AR21318R Complete Wire Harness	\$217.25
------------------	--	---	-----------------

John Deere 1010 Gas Row Crop (Up to Serial #16,648)

B3028-216	Complete Wire Harness Original Design with Generator	Replaces John Deere: #AT16691, #AT13335, #AT13986, #AT13332, #AT13344	\$352.25
------------------	--	--	-----------------

John Deere 1010 Gas Row Crop (Serial #16,649-42,000)

Complete Wire Harness

B3028-215	Original Design with Generator	Replaces John Deere: #AT16691, #AT13335, #AT13986, #AT13332, #AT13344	\$364.50
B3028-312	Modified for 10SI Alternator (3 Wire Alternator)	*Note: May Be Used With A 1 Wire Alternator, Except The Charge Indicator Lamp Will Not Work!	\$364.50

John Deere 1010 Gas Row Crop (Serial #42,001-51,039)

Complete Wire Harness

B3028-091	Original Design with Generator	Replaces John Deere: #AT17612T, #AT12932T, #AT17602T, #AT17599T, #AT161T	\$357.50
B3028-282	Modified for 10SI Alternator (3 Wire Alternator)	*Note: May Be Used With A 1 Wire Alternator, Except The Charge Indicator Lamp Will Not Work!	\$357.50

John Deere 1010 Diesel Row Crop (Serial #16640-42,000)

Complete Wire Harness

B3028-381	Original Design with Generator	Replaces John Deere: #AT16692, #AT13335, #AT13986, #AT13332, #AT13344	\$398.50
B3028-400	Modified for 10SI Alternator (3 Wire Alternator)	*Note: May Be Used With A 1 Wire Alternator, Except The Charge Indicator Lamp Will Not Work!	\$398.50

John Deere 1020, 2020 Gas, Diesel, LP Row Crop (Up to Serial #117,499)

Complete Wire Harness

B3028-202	Original Design with Motorola Alternator		\$413.00
B3028-338	Modified for 10SI Alternator (3 Wire Alternator)	*Note: May Be Used With A 1 Wire Alternator, Except The Charge Indicator Lamp Will Not Work!	\$413.00

Includes Listed Components Below and Can Be Purchased Separately

Dash & Engine Harness

B3028-203	Original Design with Motorola Alternator	Replaces John Deere: #AT20795, T23428 Dash & Engine Harness	\$257.50
B3028-337	Modified for 10SI Alternator (3 Wire Alternator)	Replaces John Deere: #AT20795, T23428 Dash & Engine Harness	\$257.50
B3028-092	Lighting Harness	Replaces John Deere: #AT20708 Lighting Harness	\$177.25

John Deere 1520 Gas, Diesel, LP Row Crop (Up to Serial #117,499)

Complete Wire Harness

B3028-439	Original Design with Motorola Alternator	Includes #AT20795, T23428 Dash & Engine	\$413.00
B3028-440	Modified for 10SI Alternator (3 Wire Alternator)	*Note: May Be Used With A 1 Wire Alternator, Except The Charge Indicator Lamp Will Not Work!	\$413.00

John Deere 2010 Gas Row Crop (Up to Serial #42,000)

Complete Wire Harness

B3028-119	Original Design with Generator	Replaces John Deere: #AT15946, #AT16866, #AT15823, #AT15823, #AT15945	\$437.75
B3028-412	Original Modified for 10SI (3-Wire) Delco Alternator	Replaces John Deere: #AT15946, #AT16866, #AT15823, #AT15823, #AT15945	\$437.75

John Deere 2020 Gas, Diesel, LP Row Crop (Up to Serial #117,499)

See #B3028-202 or #B3028-338 above

John Deere 2510 Gas & LP Row Crop with Synchro Range Transmission

B3028-303	Complete Wire Harness Original Design with Motorola Alternator		\$801.25
------------------	--	--	-----------------

Includes Listed Components Below and Can Be Purchased Separately

B3028-304	Dash & Engine Harness Original Design with Motorola Alternator	Replaces John Deere: #AR47685, R39555, AR44952 Switch Harness; #AR47686, R39641, AR44953 Instrument Harness; #AR38195, Sub for AR38873 Engine Harness	\$561.25
B3028-114	Neutral Safety Switch Harness	Replaces John Deere: #R33823 Neutral Safety Switch Harness	\$26.75
B3028-113	Lighting Harness	Replaces John Deere: #AR41284 Platform Harness; #AR39618 Rear Harness; #AR26575 Rear Harness; #AR27359 Fender Harness (2 Used)	\$217.25

John Deere 2510 Gas & LP Row Crop with Power Shift Transmission

B3028-305	Complete Wire Harness Original Design with Motorola Alternator		\$814.75
------------------	--	--	-----------------

Includes Listed Components Below and Can Be Purchased Separately

B3028-304	Dash & Engine Harness Original Design with Motorola Alternator	Replaces John Deere: #AR47685, R39555, AR44952 Switch Harness; #AR47686, R39641, AR44953 Instrument Harness; #AR38195, Sub for AR38873 Engine Harness	\$561.25
B3028-306	Neutral Safety Switch Harness	Replaces John Deere: #R38418 Neutral Safety Switch Harness	\$41.25
B3028-113	Lighting Harness	Replaces John Deere: #AR41284 Platform Harness; #AR39618 Rear Harness; #AR26575 Rear Harness; #AR27359 Fender Harness (2 Used)	\$217.25

John Deere 2510 Diesel Row Crop with Synchro Range Transmission

B3028-323	Complete Wire Harness Original Design with Motorola Alternator		\$801.25
------------------	--	--	-----------------

Includes Listed Components Below and Can Be Purchased Separately

B3028-316	Dash & Engine Harness Original Design with Motorola Alternator	Replaces John Deere: #AR47685, R39555, AR44952 Switch Harness; #AR47686, R39641, AR44953 Instrument Harness; #AR38597 Engine Harness	\$561.25
B3028-114	Neutral Safety Switch Harness	Replaces John Deere: #R33823 Neutral Safety Switch Harness	\$26.75
B3028-113	Lighting Harness	Replaces John Deere: #AR41284 Platform Harness; #AR39618 Rear Harness; #AR26575 Rear Harness; #AR27359 Fender Harness (2 Used)	\$217.25

John Deere 2510 Diesel Row Crop with Power Shift Transmission

B3028-315	Complete Wire Harness Original Design with Motorola Alternator		\$814.75
------------------	--	--	-----------------

Includes Listed Components Below and Can Be Purchased Separately

B3028-316	Dash & Engine Harness Original Design with Motorola Alternator	Replaces John Deere: #AR47685, R39555, AR44952 Switch Harness; #AR47686, R39641, AR44953 Instrument Harness; #AR38597 Engine Harness	\$561.25
B3028-306	Neutral Safety Switch Harness	Replaces John Deere: #R38418 Neutral Safety Switch Harness	\$41.25
B3028-113	Lighting Harness	Replaces John Deere: #AR41284 Platform Harness; #AR39618 Rear Harness; #AR26575 Rear Harness; #AR27359 Fender Harness (2 Used)	\$217.25

John Deere 2520 Gas Row Crop (Up to Serial #22,000) with Synchro Range Transmission

B3028-328	Complete Wire Harness Original Design		\$1,252.50
------------------	---	--	-------------------

Includes Listed Components Below and Can Be Purchased Separately

B3028-327	Engine Harness	Replaces John Deere: #AR38793, AR38974 Engine Harness	\$286.25
B3028-157	Main Harness	Replaces John Deere: #AR41683, #AR47855, #AR49349, #RE42185, #RE42186 Main Harness	\$556.25
B3028-158	Instrument Harness	Replaces John Deere: #AR45516, AR47856, AR48647, RE42182, RE42183 Instrument Harness	\$182.25
B3028-159	Fender Lighting Harness	Replaces John Deere: #AR41684 Platform Harness; #AR41696 (2 Used) Head Light Harness; #AR41699 Rear Harness; #AR41695 Flasher Harness	\$291.50

John Deere 2520 Gas Row Crop (Up to Serial #19,541) with Power Shift Transmission

B3028-330	Complete Wire Harness Original Design		\$1,313.25
------------------	---	--	-------------------

Includes Listed Components Below and Can Be Purchased Separately

B3028-327	Engine Harness	Replaces John Deere: #AR38793, AR38974 Engine Harness	\$286.25
B3028-157	Main Harness	Replaces John Deere: #AR41683, #AR47855, #AR49349, #RE42185, #RE42186 Main Harness	\$556.25
B3028-222	Instrument Harness	Replaces John Deere: #AR45517, AR48647, AR46728, AR46729, Instrument Harness	\$243.00
B3028-159	Fender Lighting Harness	Replaces John Deere: #AR41684 Platform Harness; #AR41696 (2 Used) Head Light Harness; #AR41699 Rear Harness; #AR41695 Flasher Harness	\$291.50

John Deere 2520 Gas Row Crop (Serial #19,541 to 22,000) with Power Shift Transmission

B3028-331	Complete Wire Harness Original Design		\$1,293.75
------------------	---	--	-------------------

Includes Listed Components Below and Can Be Purchased Separately

B3028-327	Engine Harness	Replaces John Deere: #AR38793, AR38974 Engine Harness	\$286.25
B3028-157	Main Harness	Replaces John Deere: #AR41683, #AR47855, #AR49349, #RE42185, #RE42186 Main Harness	\$556.25
B3028-166	Instrument Harness	Replaces John Deere: #AR47857, RE61109, AR47858 Instrument, Filter Harness	\$222.50
B3028-159	Fender Lighting Harness	Replaces John Deere: #AR41684 Platform Harness; #AR41696 (2 Used) Head Light Harness; #AR41699 Rear Harness; #AR41695 Flasher Harness	\$291.50

John Deere 2520 Gas Row Crop (Serial #22,001 & Up) with Synchro Range Transmission

B3028-329	Complete Wire Harness Original Design with 12 Volt Alternator		\$1,285.50
------------------	---	--	-------------------

Includes Listed Components Below and Can Be Purchased Separately

B3028-327	Engine Harness	Replaces John Deere: #AR38793, AR38974 Engine Harness	\$286.25
B3028-210	Main Harness	Replaces John Deere: #AR50829 Neutral Safety Switch Harness; #AR48936 Main Harness	\$560.25
B3028-211	Instrument Harness	Replaces John Deere: #AR43986 Instrument Harness	\$169.00
B3028-212	Fender Lighting Harness	Replaces John Deere: #AR41699, AR41702 Rear Harness; #AR48937, Platform Harness; #AR48938 Fender Lamp Harness (2 Used); #AR50834 2-4-Light Adaptor Lead	\$291.50
B3028-411	Fender Lamp Harness	Replaces John Deere: #AR48938 Fender Lamp Harness (2 Used)- *Note: included with B3028-212 above	\$50.50

John Deere 2520 Gas Row Crop (Serial #22,001 & Up) with Power Shift Transmission

B3028-332	Complete Wire Harness Original Design with 12 Volt Alternator		\$1,332.75
------------------	---	--	-------------------

Includes Listed Components Below and Can Be Purchased Separately

B3028-279	Engine Harness	Replaces John Deere: #AR38925 Engine Harness	\$257.50
B3028-210	Main Harness	Replaces John Deere: #AR50829 Neutral Safety Switch Harness; #AR48936 Main Harness	\$560.25
B3028-361	Instrument & Filter Harness	Replaces John Deere: #AR43987 Instrument Harness; #AR47858 Filter Harness	\$229.75
B3028-212	Fender Lighting Harness	Replaces John Deere: #AR41699, AR41702 Rear Harness; #AR48937, Platform Harness; #AR48938 Fender Lamp Harness (2 Used); #AR50834 2-4-Light Adaptor Lead	\$291.50
B3028-411	Fender Lamp Harness	Replaces John Deere: #AR48938 Fender Lamp Harness (2 Used)- *Note: included with B3028-212 above	\$50.50

John Deere 2520 Diesel Row Crop (Up to Serial #22,000) with Synchro Range Transmission

B3028-172	Complete Wire Harness Original Design		\$1252.50
------------------	---	--	------------------

Includes Listed Components Below and Can Be Purchased Separately

B3028-173	Engine Harness	Replaces John Deere: #AR38795 Engine Harness	\$271.00
B3028-157	Main Harness	Replaces John Deere: #AR41683, #AR47855, #AR49349, #RE42185, #RE42186 Main Harness	\$556.25
B3028-158	Instrument Harness	Replaces John Deere: #AR45516, AR47856, AR48647, RE42182, RE42183 Instrument Harness	\$182.25
B3028-159	Fender Lighting Harness	Replaces John Deere: #AR41684 Platform Harness; #AR41696 (2 Used) Head Light Harness; #AR41699 Rear Harness; #AR41695 Flasher Harness	\$291.50
B3028-398	Alternator Adapter Harness (Optional, not included in Complete Harness above)	Original Motorola Alternator to Delco 10SI Alternator Adaptor Assembly Harness (used when changing from Original Alternator to Delco 10SI {3 wire} Alternator)	\$20.50

John Deere 2520 Diesel Row Crop (Up to Serial #19,541) with Power Shift Transmission

B3028-270	Complete Wire Harness Original Design		\$1,313.25
------------------	---	--	-------------------

Includes Listed Components Below and Can Be Purchased Separately

B3028-173	Engine Harness	Replaces John Deere: #AR38795 Engine Harness	\$271.00
------------------	-----------------------	---	-----------------

Wiring Harnesses, Battery Cables, & Spark Plug Wires, Proudly Made in the USA!

B3028-157	Main Harness	Replaces John Deere: #AR41683, #AR47855, #AR49349, #RE42185, #RE42186 Main Harness	\$556.25
B3028-222	Instrument Harness	Replaces John Deere: #AR45517, AR48647, AR46728, AR46729, Instrument Harness	\$243.00
B3028-159	Fender Lighting Harness	Replaces John Deere: #AR41684 Platform Harness; #AR41696 (2 Used) Head Light Harness; #AR41699 Rear Harness; #AR41695 Flasher Harness	\$291.50
B3028-398	Alternator Adapter Harness (Optional, not included in Complete Harness above)	Original Motorola Alternator to Delco 10SI Alternator Adaptor Assembly Harness (used when changing from Original Alternator to Delco 10SI {3 wire} Alternator)	\$20.50

John Deere 2520 Diesel Row Crop (#19,541 to 22,000) with Power Shift Transmission

B3028-271	Complete Wire Harness Original Design		\$1,293.75
------------------	---	--	-------------------

Includes Listed Components Below and Can Be Purchased Separately

B3028-327	Engine Harness	Replaces John Deere: #AR38793, AR38974 Engine Harness	\$286.25
B3028-157	Main Harness	Replaces John Deere: #AR41683, #AR47855, #AR49349, #RE42185, #RE42186 Main Harness	\$556.25
B3028-166	Instrument Harness	Replaces John Deere: #AR47857, RE61109, AR47858 Instrument, Filter Harness	\$222.50
B3028-159	Fender Lighting Harness	Replaces John Deere: #AR41684 Platform Harness; #AR41696 (2 Used) Head Light Harness; #AR41699 Rear Harness; #AR41695 Flasher Harness	\$291.50

John Deere 2520 Diesel Row Crop (Serial #22,001 & Up) with Synchro Range Transmission

B3028-280	Complete Wire Harness Original Design with 12 Volt Alternator		\$1,273.00
------------------	---	--	-------------------

Includes Listed Components Below and Can Be Purchased Separately

B3028-279	Engine Harness	Replaces John Deere: #AR38925 Engine Harness	\$257.50
B3028-210	Main Harness	Replaces John Deere: #AR50829 Neutral Safety Switch Harness; #AR48936 Main Harness	\$560.25
B3028-211	Instrument Harness	Replaces John Deere: #AR43986 Instrument Harness	\$169.00
B3028-212	Fender Lighting Harness	Replaces John Deere: #AR41699, AR41702 Rear Harness; #AR48937, Platform Harness; #AR48938 Fender Lamp Harness (2 Used); #AR50834 2 4-Light Adaptor Lead	\$291.50
B3028-411	Fender Lamp Harness	Replaces John Deere: #AR48938 Fender Lamp Harness (2 Used)- *Note: included with B3028-212 above	\$50.50

John Deere 2520 Diesel Row Crop (Serial #22,001 & Up) with Power Shift Transmission

B3028-281	Complete Wire Harness Original Design with 12 Volt Alternator		\$1,332.75
------------------	---	--	-------------------

Includes Listed Components Below and Can Be Purchased Separately

B3028-279	Engine Harness	Replaces John Deere: #AR38925 Engine Harness	\$257.50
B3028-210	Main Harness	Replaces John Deere: #AR50829 Neutral Safety Switch Harness; #AR48936 Main Harness	\$560.25
B3028-361	Instrument & Filter Harness	Replaces John Deere: #AR43987 Instrument Harness; #AR47858 Filter Harness	\$229.75
B3028-212	Fender Lighting Harness	Replaces John Deere: #AR41699, AR41702 Rear Harness; #AR48937, Platform Harness; #AR48938 Fender Lamp Harness (2 Used); #AR50834 2 4-Light Adaptor Lead	\$291.50
B3028-411	Fender Lamp Harness	Replaces John Deere: #AR48938 Fender Lamp Harness (2 Used)- *Note: included with B3028-212 above	\$50.50

John Deere 3010 Gas & LP Utility

B3028-098	Fender Lighting Harness Original Design		\$88.50
------------------	---	--	----------------

John Deere 3010 Gas Row Crop

Complete Wire Harness

B3028-198	Original Design with Generator		\$479.00
B3028-217	Modified for Use with a 12 Volt, 10SI Delco Alternator	*Note: May be used with a 1-Wire Alternator, except the Charge Indicator Lamp will not work.	\$479.00

Includes Listed Components Below and Can Be Purchased Separately

Engine & Neutral Safety Harness

B3028-200	Original Design with Generator	Replaces John Deere: #AR26816, AR26565, AR28811, AR47648 Engine Harness; #AR26565 Generator to Regulator Harness; #AR28921 Neutral Safety Switch Harness	\$271.00
B3028-201	Modified for Use with a Replacement 12 Volt, 10SI Delco Alternator	Replaces John Deere: #AR26816, AR26565, AR28811, AR47648 Engine Harness; #AR28921 Neutral Safety Switch Harness	\$271.00
B3028-101	Lighting Harness	Replaces John Deere: #AR26752 Switch to Fender Harness; #AR28289 AR26753 Switch to Rear Harness; #AR26575 Rear Harness; #AR27359 Fender Harness (2 Used); #AR27656 Starter to Rear harness (Has Fuse Holder)	\$210.00

John Deere 3010 LP Row Crop

Complete Wire Harness

B3028-340	Original Design with Generator		\$479.00
B3028-423	Modified for Use with a 12 Volt, 10SI Delco Alternator		\$479.00

Includes Listed Components Below and Can Be Purchased Separately

Engine & Dash Harness

B3028-341	Original Design with Generator	Replaces John Deere: #AR26817, AR28812, AR47647 Engine Harness; #AR26565 Generator to Regulator Harness; #AR28921 Neutral Safety Switch Harness	\$271.00
B3028-422	Modified for Use with a 12 Volt, 10SI Delco Alternator	Per B3028-341 above	\$271.00
B3028-101	Lighting Harness	Replaces John Deere: #AR26752 Switch to Fender Harness; #AR28289 AR26753 Switch to Rear Harness; #AR26575 Rear Harness; #AR27359 Fender Harness (2 Used); #AR27656 Starter to Rear harness (Has Fuse Holder)	\$210.00

John Deere 3010 Gas Standard

Complete Wire Harness

B3028-289	Original Design with Generator		\$398.50
B3028-294	Modified for Use with a 12 Volt, 10SI Delco Alternator	*Note: May be used with a 1-Wire Alternator, except the Charge Indicator Lamp will not work.	\$398.50

Includes Listed Components Below and Can Be Purchased Separately

Engine & Neutral Safety Harness

B3028-200	Original Design with Generator	Replaces John Deere: #AR26816, AR26565, AR28811, AR47648 Engine Harness; #AR26565 Generator to Regulator Harness; #AR28921 Neutral Safety Switch Harness	\$271.00
B3028-201	Modified for Use with a Replacement 12 Volt, 10SI Delco Alternator	Replaces John Deere: #AR26816, AR26565, AR28811, AR47648 Engine Harness; #AR28921 Neutral Safety Switch Harness	\$271.00
B3028-293	Lighting Harness	Replaces John Deere: #AR26616, AR28418, AR28419 Switch to Fender Harness; #AR28289, AR26753 Switch to Rear Harness; #AR26575 Rear Light Harness; #AR27239 Fender Harness (2 Used); #AR27656 Starter to Rear harness (Has Fuse Holder)	\$129.75

John Deere 3010 Diesel Row Crop

Complete Wire Harness

B3028-099	Original Design with 24 Volt Generator	Replaces John Deere: #AR47646 Complete Harness	\$479.00
B3028-170	Modified for Use with a Replacement 12 Volt, 10SI Delco Alternator	*Note: May be used with a 1-Wire Alternator, except the Charge Indicator Lamp will not work.	\$479.00

Includes Listed Components Below and Can Be Purchased Separately

Engine & Neutral Safety Harness

B3028-100	Original Design with 24 Volt Generator	Replaces John Deere: #AR47679 Engine Harness; #AR28921 Neutral Safety Switch Harness	\$283.25
B3028-171	Modified for Use with a Replacement 12 Volt, 10SI Delco Alternator	Replaces John Deere: #AR47679 Engine Harness; #AR28921 Neutral Safety Switch Harness	\$283.25
B3028-101	Lighting Harness	Replaces John Deere: #AR26752 Switch to Fender Harness; #AR28289 AR26753 Switch to Rear Harness; #AR26575 Rear Harness; #AR27359 Fender Harness (2 Used); #AR27656 Starter to Rear harness (Has Fuse Holder)	\$210.00

John Deere 3010 Diesel Standard

Complete Wire Harness

B3028-291	Original Design with 24 Volt Generator	Replaces John Deere: #AR47646 Complete Harness	\$398.50
B3028-295	Modified for Use with a Replacement 12 Volt, 10SI Delco Alternator	*Note: May be used with a 1-Wire Alternator, except the Charge Indicator Lamp will not work.	\$398.50

John Deere 3020 Gas & LP Row Crop (Up to Serial #67,999) with Synchro Range Transmission

Complete Wire Harness

B3028-336	Original Design with Generator		\$491.25
B3028-402	Modified for Use with a Replacement 12 Volt, 10SI Delco Alternator	*Note: May be used with a 1-Wire Alternator, except the Charge Indicator Lamp will not work.	\$491.25

Includes Listed Components Below and Can Be Purchased Separately

Main Engine Harness

B3028-301	Original Design with Generator	Replaces John Deere: #AR47650, Sub for R34274 Main Harness	\$257.50
B3028-401	Modified for Use with a Replacement 12 Volt, 10SI Delco Alternator	Replaces John Deere: #AR47650, Sub for R34274 Main Harness	\$257.50
B3028-114	Neutral Safety Switch Harness	Replaces John Deere: #R33823 Neutral Safety Switch Harness	\$26.75
B3028-101	Lighting Harness	Replaces John Deere: #AR26752 Switch to Fender Harness; #AR28289 AR26753 Switch to Rear Harness; #AR26575 Rear Harness; #AR27359 Fender Harness (2 Used); #AR27656 Starter to Rear harness (Has Fuse Holder)	\$210.00

John Deere 3020 Gas & LP Row Crop (Up to Serial #57,369) with Power Shift Transmission

Complete Wire Harness

B3028-399	Original Design with Generator		\$491.25
B3028-403	Modified for Use with a Replacement 12 Volt, 10SI Delco Alternator	*Note: May be used with a 1-Wire Alternator, except the Charge Indicator Lamp will not work.	\$491.25

Includes Listed Components Below and Can Be Purchased Separately

Main Engine Harness

B3028-301	Original Design with Generator	Replaces John Deere: #AR47650, Sub for R34274 Main Harness	\$257.50
B3028-401	Modified for Use with a Replacement 12 Volt, 10SI Delco Alternator	Replaces John Deere: #AR47650, Sub for R34274 Main Harness	\$257.50
B3028-193	Neutral Safety Switch Harness	Replaces John Deere: #R33770 Neutral Safety Switch Harness	\$22.75
B3028-101	Lighting Harness	Replaces John Deere: #AR26752 Switch to Fender Harness; #AR28289 AR26753 Switch to Rear Harness; #AR26575 Rear Harness; #AR27359 Fender Harness (2 Used); #AR27656 Starter to Rear harness (Has Fuse Holder)	\$210.00

John Deere 3020 Gas & LP Row Crop (Serial #57,370–67,999) with Power Shift Transmission

Complete Wire Harness

B3028-302	Original Design with Generator		\$505.75
B3028-404	Modified for Use with a Replacement 12 Volt, 10SI Delco Alternator	*Note: May be used with a 1-Wire Alternator, except the Charge Indicator Lamp will not work.	\$505.75

Includes Listed Components Below and Can Be Purchased Separately

Main Engine Harness

B3028-301	Original Design with Generator	Replaces John Deere: #AR47650, Sub for R34274 Main Harness	\$257.50
B3028-401	Modified for Use with a Replacement 12 Volt, 10SI Delco Alternator	Replaces John Deere: #AR47650, Sub for R34274 Main Harness	\$257.50
B3028-115	Neutral Safety Switch Harness	Replaces John Deere: #R34869 Neutral Safety Switch Harness	\$41.25
B3028-101	Lighting Harness	Replaces John Deere: #AR26752 Switch to Fender Harness; #AR28289 AR26753 Switch to Rear Harness; #AR26575 Rear Harness; #AR27359 Fender Harness (2 Used); #AR27656 Starter to Rear harness (Has Fuse Holder)	\$210.00

John Deere 3020 Gas & LP Row Crop (Serial #68,000 to 122,999) with Synchro Range Transmission

Complete Wire Harness

B3028-182	Original Design with Generator		\$801.25
B3028-354	Modified for Use with a Replacement 12 Volt, 10SI Delco Alternator	*Note: May be used with a 1-Wire Alternator, except the Charge Indicator Lamp will not work.	\$801.25

Includes Listed Components Below and Can Be Purchased Separately

Dash & Engine Harness

B3028-175	Original Design with Generator	Replaces John Deere: # Original Design with Generator; #AR47685, R39555, AR44952 Switch Harness; #AR47686, R39641, AR44953 Instrument Harness; #AR47687 Engine Harness	\$587.00
------------------	--------------------------------	---	-----------------

B3028-353	Modified for Use with a Replacement 12 Volt, 10SI Delco Alternator	See B3028-175 above	\$587.00
B3028-114	Neutral Safety Switch Harness	Replaces John Deere: #R33823 Neutral Safety Switch Harness	\$26.75
B3028-113	Lighting Harness	Replaces John Deere: #AR41284 Platform Harness; #AR39618 Rear Harness; AR26575 Rear Harness; #AR27359 Fender Harness (2 Used)	\$217.25

John Deere 3020 Gas & LP Row Crop (Serial #68,000 to 122,999) with Power Shift Transmission

Complete Wire Harness

B3028-174	Original Design with Generator		\$814.75
B3028-356	Modified for Use with a Replacement 12 Volt, 10SI Delco Alternator	*Note: May be used with a 1-Wire Alternator, except the Charge Indicator Lamp will not work.	\$814.75

Includes Listed Components Below and Can Be Purchased Separately

Dash & Engine Harness

B3028-175	Original Design with Generator	Replaces John Deere: # Original Design with Generator; #AR47685, R39555, AR44952 Switch Harness; #AR47686, R39641, AR44953 Instrument Harness; #AR47687 Engine Harness	\$587.00
B3028-353	Modified for Use with a Replacement 12 Volt, 10SI Delco Alternator	See B3028-175 above	\$587.00
B3028-115	Neutral Safety Switch Harness	Replaces John Deere: #R34869 Neutral Safety Switch Harness	\$41.25
B3028-113	Lighting Harness	Replaces John Deere: #AR41284 Platform Harness; #AR39618 Rear Harness; AR26575 Rear Harness; #AR27359 Fender Harness (2 Used)	\$217.25

John Deere 3020 Gas & LP Utility (Serial #68,000 to 122,999) with Synchro Range Transmission

Complete Wire Harness

B3028-273	Original Design with Generator		\$755.00
B3028-355	Modified for Use with a Replacement 12 Volt, 10SI Delco Alternator	*Note: May be used with a 1-Wire Alternator, except the Charge Indicator Lamp will not work.	\$755.00

Includes Listed Components Below and Can Be Purchased Separately

Dash & Engine Harness

B3028-175	Original Design with Generator	Replaces John Deere: # Original Design with Generator; #AR47685, R39555, AR44952 Switch Harness; #AR47686, R39641, AR44953 Instrument Harness; #AR47687 Engine Harness	\$587.00
B3028-353	Modified for Use with a Replacement 12 Volt, 10SI Delco Alternator	See B3028-175 above	\$587.00
B3028-114	Neutral Safety Switch Harness	Replaces John Deere: #R33823 Neutral Safety Switch Harness	\$26.75
B3028-272	Lighting Harness	Replaces John Deere: #AR41284 Platform Harness; #AR37654 Fender Harness	\$169.00

John Deere 3020 Gas & LP Utility (Serial #68,000 to 122,999) with Power Shift Transmission

Complete Wire Harness

B3028-274	Original Design with Generator		\$767.25
B3028-357	Modified for Use with a Replacement 12 Volt, 10SI Delco Alternator	*Note: May be used with a 1-Wire Alternator, except the Charge Indicator Lamp will not work.	\$767.25

Includes Listed Components Below and Can Be Purchased Separately

Dash & Engine Harness

B3028-175	Original Design with Generator	Replaces John Deere: Original Design with Generator; #AR47685, R39555, AR44952 Switch Harness; #AR47686, R39641, AR44953 Instrument Harness; #AR47687 Engine Harness	\$587.00
B3028-353	Modified for Use with a Replacement 12 Volt, 10SI Delco Alternator	See B3028-175 above	\$587.00
B3028-115	Neutral Safety Switch Harness	Replaces John Deere: #R34869 Neutral Safety Switch Harness	\$41.25
B3028-272	Lighting Harness	Replaces John Deere: #AR41284 Platform Harness; #AR37654 Fender Harness	\$169.00

John Deere 3020 Gas & LP Row Crop (Serial #123,000 to 150,000) with Synchro Range Transmission

B3028-445	Complete Wire Harness Original Design with 12 Volt Alternator		\$1,236.00
------------------	---	--	-------------------

Includes Listed Components Below and Can Be Purchased Separately

B3028-444	Engine Harness	Replaces John Deere: #AR41685 Engine Harness, AR47086 Relay Harness	\$290.50
B3028-157	Main Harness	Replaces John Deere: #AR41683, AR47855, AR49349, RE42185, RE42186 Main Harness	\$556.25
B3028-158	Instrument Harness	Replaces John Deere: #AR45516, AR47856, AR48647, RE42182, RE42183 Instrument Harness	\$182.25
B3028-159	Fender Lighting Harness	Replaces John Deere: #AR41684 Platform Harness; #AR41696 (2 Used) Head Light Harness; #AR41699 Rear Harness; #AR41695 Flasher Harness	\$291.50

John Deere 3020 Diesel Row Crop (Up to Serial #67,999) with Synchro Range Transmission

Complete Wire Harness

B3028-187	Original Design with 24 Volt Generator		\$525.25
B3028-188	Modified for Use with a Replacement 12 Volt, 10SI Delco Alternator	*Note: May be used with a 1-Wire Alternator, except the Charge Indicator Lamp will not work.	\$525.25

Includes Listed Components Below and Can Be Purchased Separately

Main Engine Harness

B3028-191	Original Design with 24 Volt Generator	Replaces John Deere: #AR34275 Main Harness	\$291.50
B3028-192	Modified for Use with a Replacement 12 Volt, 10SI Delco Alternator	Replaces John Deere: #AR34275 Main Harness	\$291.50
B3028-114	Neutral Safety Switch Harness	Replaces John Deere: #R33823 Neutral Safety Switch Harness	\$26.75
B3028-101	Lighting Harness	Replaces John Deere: #AR26752 Switch to Fender Harness; #AR28289 AR26753 Switch to Rear Harness; #AR26575 Rear Harness; #AR27359 Fender Harness (2 Used); #AR27656 Starter to Rear harness (Has Fuse Holder)	\$210.00

John Deere 3020 Diesel High Crop (Up to Serial #67,999) with Synchro Range Transmission

Complete Wire Harness

B3028-334	Original Design with 24 Volt Generator		\$491.25
B3028-335	Modified for Use with a Replacement 12 Volt, 10SI Delco Alternator	*Note: May be used with a 1-Wire Alternator, except the Charge Indicator Lamp will not work.	\$491.25

Includes Listed Components Below and Can Be Purchased Separately

Main Engine Harness

B3028-191	Original Design with 24 Volt Generator	Replaces John Deere: #AR34275 Main Harness	\$291.50
B3028-192	Modified for Use with a Replacement 12 Volt, 10SI Delco Alternator	Replaces John Deere: #AR34275 Main Harness	\$291.50
B3028-114	Neutral Safety Switch Harness	Replaces John Deere: #R33823 Neutral Safety Switch Harness	\$26.75
B3028-333	Lighting Harness	Replaces John Deere: #AR27240 Switch to Light Lead Harness; #AR28289, AR26753 Switch to Rear Harness; #AR26575 Rear Light Harness; #AR39653 Light Lead (2 Used)	\$177.25

John Deere 3020 Diesel Row Crop (Up to Serial #57,369) with Power Shift Transmission

Complete Wire Harness

B3028-189	Original Design with 24 Volt Generator		\$524.25
B3028-190	Modified for Use with a Replacement 12 Volt, 10SI Delco Alternator	*Note: May be used with a 1-Wire Alternator, except the Charge Indicator Lamp will not work.	\$524.25

Includes Listed Components Below and Can Be Purchased Separately

Main Engine Harness

B3028-191	Original Design with 24 Volt Generator	Replaces John Deere: #AR34275 Main Harness	\$291.50
B3028-192	Modified for Use with a Replacement 12 Volt, 10SI Delco Alternator	Replaces John Deere: #AR34275 Main Harness	\$291.50
B3028-193	Neutral Safety Switch Harness	Replaces John Deere: #R33770 Neutral Safety Switch Harness	\$22.75
B3028-101	Lighting Harness	Replaces John Deere: #AR26752 Switch to Fender Harness; #AR28289 AR26753 Switch to Rear Harness; #AR26575 Rear Harness; #AR27359 Fender Harness (2 Used); #AR27656 Starter to Rear harness (Has Fuse Holder)	\$210.00

John Deere 3020 Diesel Row Crop (Serial #57,370–67,999) with Power Shift Transmission

Complete Wire Harness

B3028-194	Original Design with 24 Volt Generator		\$538.75
B3028-195	Modified for Use with a Replacement 12 Volt, 10SI Delco Alternator	*Note: May be used with a 1-Wire Alternator, except the Charge Indicator Lamp will not work.	\$538.75

Includes Listed Components Below and Can Be Purchased Separately

Main Engine Harness

B3028-191	Original Design with 24 Volt Generator	Replaces John Deere: #AR34275 Main Harness	\$291.50
B3028-192	Modified for Use with a Replacement 12 Volt, 10SI Delco Alternator	Replaces John Deere: #AR34275 Main Harness	\$291.50
B3028-115	Neutral Safety Switch Harness	Replaces John Deere: #R34869 Neutral Safety Switch Harness	\$41.25
B3028-101	Lighting Harness	Replaces John Deere: #AR26752 Switch to Fender Harness; #AR28289 AR26753 Switch to Rear Harness; #AR26575 Rear Harness; #AR27359 Fender Harness (2 Used); #AR27656 Starter to Rear harness (Has Fuse Holder)	\$210.00

John Deere 3020 Diesel Row Crop (Serial #68,000-122,999) with Synchro Range Transmission

Complete Wire Harness

B3028-103	Original Design with 24 Volt Generator		\$789.00
B3028-197	Modified for Use with a Replacement 12 Volt, 10SI Delco Alternator	*Note: May be used with a 1-Wire Alternator, except the Charge Indicator Lamp will not work.	\$789.00

Includes Listed Components Below and Can Be Purchased Separately

Dash & Engine Harness

B3028-104	Original Design with 24 Volt Generator	Replaces John Deere: #AR47685, R39555, AR44952 Switch Harness; #AR47686, R39641, AR44953 Instrument Harness; #AR47684 Engine Harness	\$548.00
B3028-199	Modified for Use with a Replacement 12 Volt, 10SI Delco Alternator	See B3028-104 above	\$548.00
B3028-114	Neutral Safety Switch Harness	Replaces John Deere: #R33823 Neutral Safety Switch Harness	\$26.75
B3028-113	Lighting Harness	Replaces John Deere: #AR41284 Platform Harness; #AR39618 Rear Harness; AR26575 Rear Harness; #AR27359 Fender Harness (2 Used)	\$217.25

John Deere 3020 Diesel Utility (Serial #68,000-122,999) with Synchro Range Transmission

Complete Wire Harness

B3028-275	Original Design with 24 Volt Generator		\$741.50
B3028-276	Modified for Use with a Replacement 12 Volt, 10SI Delco Alternator	*Note: May be used with a 1-Wire Alternator, except the Charge Indicator Lamp will not work.	\$741.50

Includes Listed Components Below and Can Be Purchased Separately

Dash & Engine Harness

B3028-104	Original Design with 24 Volt Generator	Replaces John Deere: #AR47685, R39555, AR44952 Switch Harness; #AR47686, R39641, AR44953 Instrument Harness; #AR47684 Engine Harness	\$548.00
B3028-199	Modified for Use with a Replacement 12 Volt, 10SI Delco Alternator	See B3028-104 above	\$548.00
B3028-114	Neutral Safety Switch Harness	Replaces John Deere: #R33823 Neutral Safety Switch Harness	\$26.75
B3028-272	Lighting Harness	Replaces John Deere: #AR41284 Platform Harness; #AR37654 Fender Harness	\$169.00

John Deere 3020 Diesel Row Crop (Serial #68,000-122,999) with Power Shift Transmission

Complete Wire Harness

B3028-179	Original Design with 24 Volt Generator		\$801.25
B3028-288	Modified for Use with a Replacement 12 Volt, 10SI Delco Alternator	*Note: May be used with a 1-Wire Alternator, except the Charge Indicator Lamp will not work.	\$801.25

Includes Listed Components Below and Can Be Purchased Separately

Dash & Engine Harness

B3028-104	Original Design with 24 Volt Generator	Replaces John Deere: #AR47685, R39555, AR44952 Switch Harness; #AR47686, R39641, AR44953 Instrument Harness; #AR47684 Engine Harness	\$548.00
B3028-199	Modified for Use with a Replacement 12 Volt, 10SI Delco Alternator	See B3028-104 above	\$548.00
B3028-115	Neutral Safety Switch Harness	Replaces John Deere: #R34869 Neutral Safety Switch Harness	\$41.25
B3028-113	Lighting Harness	Replaces John Deere: #AR41284 Platform Harness; #AR39618 Rear Harness; AR26575 Rear Harness; #AR27359 Fender Harness (2 Used)	\$217.25

John Deere 3020 Diesel Utility (Serial #68,000-122,999) with Power Shift Transmission

Complete Wire Harness

B3028-277	Original Design with 24 Volt Generator		\$755.00
B3028-278	Modified for Use with a Replacement 12 Volt, 10SI Delco Alternator	*Note: May be used with a 1-Wire Alternator, except the Charge Indicator Lamp will not work.	\$755.00

Includes Listed Components Below and Can Be Purchased Separately

Dash & Engine Harness

B3028-104	Original Design with 24 Volt Generator	Replaces John Deere: #AR47685, R39555, AR44952 Switch Harness; #AR47686, R39641, AR44953 Instrument Harness; #AR47684 Engine Harness	\$548.00
B3028-199	Modified for Use with a Replacement 12 Volt, 10SI Delco Alternator	See B3028-104 above	\$548.00
B3028-115	Neutral Safety Switch Harness	Replaces John Deere: #R34869 Neutral Safety Switch Harness	\$41.25
B3028-272	Lighting Harness	Replaces John Deere: #AR41284 Platform Harness; #AR37654 Fender Harness	\$169.00

John Deere 3020 Diesel Row Crop (Serial #123,000-150,000) with Synchro Range Transmission

B3028-300	Complete Wire Harness Original Design with 12 Volt Alternator		\$1,233.00
------------------	--	--	-------------------

Includes Listed Components Below and Can Be Purchased Separately

B3028-169	Engine Harness	Replaces John Deere: #AR41688 Engine Harness	\$286.25
B3028-157	Main Harness	Replaces John Deere: #AR41683, AR47855, AR49349, RE42185, RE42186 Main Harness	\$556.25
B3028-158	Instrument Harness	Replaces John Deere: #AR45516, AR47856, AR48647, RE42182, RE42183 Instrument Harness	\$182.25
B3028-159	Fender Lighting Harness	Replaces John Deere: #AR41684 Platform Harness; #AR41696 (2 Used) Head Light Harness; #AR41699 Rear Harness; #AR41695 Flasher Harness	\$291.50
B3028-398	Alternator Adapter Harness (Optional, not included in Complete Harness above)	Original Motorola Alternator to Delco 10SI Alternator Adaptor Assembly Harness (used when changing from Original Alternator to Delco 10SI {3 wire} Alternator)	\$20.50

John Deere 3020 Diesel Row Crop (Serial #123,000-130,206) with Power Shift Transmission

B3028-223	Complete Wire Harness Original Design with 12 Volt Alternator		\$1,299.75
------------------	--	--	-------------------

Includes Listed Components Below and Can Be Purchased Separately

B3028-169	Engine Harness	Replaces John Deere: #AR41688 Engine Harness	\$286.25
B3028-157	Main Harness	Replaces John Deere: #AR41683, AR47855, AR49349, RE42185, RE42186 Main Harness	\$556.25
B3028-222	Instrument Harness	Replaces John Deere: #AR45517, AR48647, AR46728, AR46729, Instrument Harness	\$243.00
B3028-159	Fender Lighting Harness	Replaces John Deere: #AR41684 Platform Harness; #AR41696 (2 Used) Head Light Harness; #AR41699 Rear Harness; #AR41695 Flasher Harness	\$291.50
B3028-398	Alternator Adapter Harness (Optional, not included in Complete Harness above)	Original Motorola Alternator to Delco 10SI Alternator Adaptor Assembly Harness (used when changing from Original Alternator to Delco 10SI {3 wire} Alternator)	\$20.50

John Deere 3020 Diesel Row Crop (Serial #130,207-150,000) with Power Shift Transmission

B3028-168	Complete Wire Harness Original Design with 12 Volt Alternator		\$1,299.75
------------------	--	--	-------------------

Includes Listed Components Below and Can Be Purchased Separately

B3028-169	Engine Harness	Replaces John Deere: #AR41688 Engine Harness	\$286.25
B3028-157	Main Harness	Replaces John Deere: #AR41683, AR47855, AR49349, RE42185, RE42186 Main Harness	\$556.25
B3028-166	Instrument Harness	Replaces John Deere: #AR47857, RE61109, AR47858 Instrument, Filter Harness	\$222.50
B3028-159	Fender Lighting Harness	Replaces John Deere: #AR41684 Platform Harness; #AR41696 (2 Used) Head Light Harness; #AR41699 Rear Harness; #AR41695 Flasher Harness	\$291.50

B3028-398	Alternator Adapter Harness (Optional, not included in Complete Harness above)	Original Motorola Alternator to Delco 10SI Alternator Adaptor Assembly Harness (used when changing from Original Alternator to Delco 10SI {3 wire} Alternator)	\$20.50
------------------	---	--	----------------

John Deere 3020 Diesel Row Crop (Serial #150,001 & Up) with Synchro Range Transmission

B3028-366	Complete Wire Harness Original Design with 12 Volt Alternator		\$1,273.00
------------------	---	--	-------------------

Includes Listed Components Below and Can Be Purchased Separately

B3028-365	Engine Harness	Replaces John Deere: #AR52731, AR50824 Engine Harness, #AR43609 Battery to Starter Relay	\$257.50
B3028-210	Main Harness	Replaces John Deere: #AR48936 Main Harness	\$560.25
B3028-211	Instrument Harness	Replaces John Deere: #AR43986 Instrument Harness	\$169.00
B3028-212	Fender Lighting Harness	Replaces John Deere: #AR41699, AR41702 Rear Harness; #AR48937, Platform Harness; #AR48938 Fender Lamp Harness (2 Used); #AR50834 2 4-Light Adaptor Lead	\$291.50
B3028-411	Fender Lamp Harness	Replaces John Deere: #AR48938 Fender Lamp Harness (2 Used)- *Note: included with B3028-212 above	\$50.50
B3028-398	Alternator Adapter Harness (Optional, not included in Complete Harness above)	Original Motorola Alternator to Delco 10SI Alternator Adaptor Assembly Harness (used when changing from Original Alternator to Delco 10SI {3 wire} Alternator)	\$20.50

John Deere 3020 Diesel Row Crop (Serial #150,001 & Up) with Power Shift Transmission

B3028-367	Complete Wire Harness Original Design with 12 Volt Alternator		\$1,332.75
------------------	---	--	-------------------

Includes Listed Components Below and Can Be Purchased Separately

B3028-365	Engine Harness	Replaces John Deere: #AR52731, AR50824 Engine Harness, #AR43609 Battery to Starter Relay	\$257.50
B3028-210	Main Harness	Replaces John Deere: #AR48936 Main Harness	\$560.25
B3028-361	Instrument & Filter Harness	Replaces John Deere: #AR43987 Instrument Harness; #AR47858 Filter Harness	\$229.75
B3028-212	Fender Lighting Harness	Replaces John Deere: #AR41699, AR41702 Rear Harness; #AR48937, Platform Harness; #AR48938 Fender Lamp Harness (2 Used); #AR50834 2 4-Light Adaptor Lead	\$291.50
B3028-411	Fender Lamp Harness	Replaces John Deere: #AR48938 Fender Lamp Harness (2 Used)- *Note: included with B3028-212 above	\$50.50
B3028-398	Alternator Adapter Harness (Optional, not included in Complete Harness above)	Original Motorola Alternator to Delco 10SI Alternator Adaptor Assembly Harness (used when changing from Original Alternator to Delco 10SI {3 wire} Alternator)	\$20.50

John Deere 4000 Gas & LP Row Crop (Serial #201,000-250,000) with Synchro Range Transmission

B3028-389	Complete Wire Harness Original Design with 12 Volt Alternator		\$1,246.25
------------------	---	--	-------------------

Includes Listed Components Below and Can Be Purchased Separately

B3028-388	Engine Harness	Replaces John Deere: #AR41685 Engine Harness, AR47086 Relay Harness	\$300.75
B3028-157	Main Harness	Replaces John Deere: #AR41683, AR47855, AR49349, RE42185, RE42186 Main Harness	\$556.25
B3028-158	Instrument Harness	Replaces John Deere: #AR45516, AR47856, AR48647, RE42182, RE42183 Instrument Harness	\$182.25
B3028-159	Fender Lighting Harness	Replaces John Deere: #AR41684 Platform Harness; #AR41696 (2 Used) Head Light Harness; #AR41699 Rear Harness; #AR41695 Flasher Harness	\$291.50
B3028-398	Alternator Adapter Harness (Optional, not included in Complete Harness above)	Original Motorola Alternator to Delco 10SI Alternator Adaptor Assembly Harness (used when changing from Original Alternator to Delco 10SI {3 wire} Alternator)	\$20.50

John Deere 4000 Gas & LP (Serial #211,492-222,918) with Power Shift Transmission

B3028-390	Complete Wire Harness Original Design with 12 Volt Alternator		\$1,313.25
------------------	---	--	-------------------

Includes Listed Components Below and Can Be Purchased Separately

B3028-388	Engine Harness	Replaces John Deere: #AR41685 Engine Harness, AR47086 Relay Harness	\$300.75
------------------	-----------------------	--	-----------------

Wiring Harnesses, Battery Cables, & Spark Plug Wires, Proudly Made in the USA!

B3028-157	Main Harness	Replaces John Deere: #AR41683, AR47855, AR49349, RE42185, RE42186 Main Harness	\$556.25
B3028-222	Instrument Harness	Replaces John Deere: #AR45517, AR48647, AR46728, AR46729, Instrument Harness	\$243.00
B3028-159	Fender Lighting Harness	Replaces John Deere: #AR41684 Platform Harness; #AR41696 (2 Used) Head Light Harness; #AR41699 Rear Harness; #AR41695 Flasher Harness	\$291.50
B3028-375	Power Front Wheel Drive Harness (Optional, not included in above listed Complete Harness)	Replaces John Deere: #AR49479 Shift Speed Switch Harness; #AR4539 Extension Harness; #AR45734 Control Valve Harness; #AR49432 Clutch Switch Harness	\$238.00
B3028-398	Alternator Adapter Harness (Optional, not included in Complete Harness above)	Original Motorola Alternator to Delco 10SI Alternator Adaptor Assembly Harness (used when changing from Original Alternator to Delco 10SI {3 wire} Alternator)	\$20.50

John Deere 4000 Gas, & LP (Serial #222, 919-250,000) with Power Shift Transmission

B3028-391	Complete Wire Harness Original Design with 12 Volt Alternator		\$1,313.25
------------------	---	--	-------------------

Includes Listed Components Below and Can Be Purchased Separately

B3028-388	Engine Harness	Replaces John Deere: #AR41685 Engine Harness, AR47086 Relay Harness	\$300.75
B3028-157	Main Harness	Replaces John Deere: #AR41683, AR47855, AR49349, RE42185, RE42186 Main Harness	\$556.25
B3028-166	Instrument Harness	Replaces John Deere: #AR47857, RE61109, AR47858 Instrument, Filter Harness	\$222.50
B3028-159	Fender Lighting Harness	Replaces John Deere: #AR41684 Platform Harness; #AR41696 (2 Used) Head Light Harness; #AR41699 Rear Harness; #AR41695 Flasher Harness	\$291.50
B3028-375	Power Front Wheel Drive Harness (Optional, not included in above listed Complete Harness)	Replaces John Deere: #AR49479 Shift Speed Switch Harness; #AR4539 Extension Harness; #AR45734 Control Valve Harness; #AR49432 Clutch Switch Harness	\$238.00
B3028-398	Alternator Adapter Harness (Optional, not included in Complete Harness above)	Original Motorola Alternator to Delco 10SI Alternator Adaptor Assembly Harness (used when changing from Original Alternator to Delco 10SI {3 wire} Alternator)	\$20.50

John Deere 4000 Gas & LP (Serial #250,001 & Up) with Synchro Range Transmission

B3028-208	Complete Wire Harness Original Design with 12 Volt Alternator		\$1,285.50
------------------	---	--	-------------------

Includes Listed Components Below and Can Be Purchased Separately

B3028-209	Engine Harness	Replaces John Deere: #AR50827 Engine Harness	\$271.00
B3028-210	Main Harness	Replaces John Deere: #AR48936 Main Harness	\$560.25
B3028-211	Instrument Harness	Replaces John Deere: #AR43986 Instrument Harness	\$169.00
B3028-212	Fender Lighting Harness	Replaces John Deere: #AR41699, AR41702 Rear Harness; #AR48937, Platform Harness; #AR48938 Fender Lamp Harness (2 Used); #AR50834 2 4-Light Adaptor Lead	\$291.50
B3028-411	Fender Lamp Harness	Replaces John Deere: #AR48938 Fender Lamp Harness (2 Used)- *Note: included with B3028-212 above	\$50.50
B3028-398	Alternator Adapter Harness (Optional, not included in Complete Harness above)	Original Motorola Alternator to Delco 10SI Alternator Adaptor Assembly Harness (used when changing from Original Alternator to Delco 10SI {3 wire} Alternator)	\$20.50

John Deere 4000 Gas & LP (Serial #250,001 & Up) with Power Shift Transmission

B3028-269	Complete Wire Harness Original Design with 12 Volt Alternator		\$1,340.00
------------------	---	--	-------------------

Includes Listed Components Below and Can Be Purchased Separately

B3028-209	Engine Harness	Replaces John Deere: #AR50827 Engine Harness	\$271.00
B3028-210	Main Harness	Replaces John Deere: #AR48936 Main Harness	\$560.25
B3028-361	Instrument & Filter Harness	Replaces John Deere: #AR43987 Instrument Harness; #AR47858 Filter Harness	\$229.75
B3028-212	Fender Lighting Harness	Replaces John Deere: #AR41699, AR41702 Rear Harness; #AR48937, Platform Harness; #AR48938 Fender Lamp Harness (2 Used); #AR50834 2 4-Light Adaptor Lead	\$291.50
B3028-411	Fender Lamp Harness	Replaces John Deere: #AR48938 Fender Lamp Harness (2 Used)- *Note: included with B3028-212 above	\$50.50

B3028-398	Alternator Adapter Harness (Optional, not included in Complete Harness above)	Original Motorola Alternator to Delco 10SI Alternator Adaptor Assembly Harness (used when changing from Original Alternator to Delco 10SI { 3 wire } Alternator)	\$20.50
------------------	---	--	----------------

John Deere 4000 Diesel (Serial #211,492-250,000) with Synchro Range Transmission

B3028-155	Complete Wire Harness Original Design with 12 Volt Alternator		\$1,233.00
------------------	---	--	-------------------

Includes Listed Components Below and Can Be Purchased Separately

B3028-156	Engine Harness	Replaces John Deere: #AR41686 Engine Harness, #AR47086 Relay Harness	\$286.25
B3028-157	Main Harness	Replaces John Deere: #AR41683, AR47855, AR49349, RE42185, RE42186 Main Harness	\$556.25
B3028-158	Instrument Harness	Replaces John Deere: #AR45516, AR47856, AR48647, RE42182, RE42183 Instrument Harness	\$182.25
B3028-159	Fender Lighting Harness	Replaces John Deere: #AR41684 Platform Harness; #AR41696 (2 Used) Head Light Harness; #AR41699 Rear Harness; #AR41695 Flasher Harness	\$291.50
B3028-398	Alternator Adapter Harness (Optional, not included in Complete Harness above)	Original Motorola Alternator to Delco 10SI Alternator Adaptor Assembly Harness (used when changing from Original Alternator to Delco 10SI { 3 wire } Alternator)	\$20.50

John Deere 4000 Diesel (Serial #211,492-222,918) with Power Shift Transmission

B3028-221	Complete Wire Harness Original Design with 12 Volt Alternator		\$1,299.75
------------------	---	--	-------------------

Includes Listed Components Below and Can Be Purchased Separately

B3028-156	Engine Harness	Replaces John Deere: #AR41686 Engine Harness, #AR47086 Relay Harness	\$286.25
B3028-157	Main Harness	Replaces John Deere: #AR41683, AR47855, AR49349, RE42185, RE42186 Main Harness	\$556.25
B3028-222	Instrument Harness	Replaces John Deere: #AR45517, AR48647, AR46728, AR46729, Instrument Harness	\$243.00
B3028-159	Fender Lighting Harness	Replaces John Deere: #AR41684 Platform Harness; #AR41696 (2 Used) Head Light Harness; #AR41699 Rear Harness; #AR41695 Flasher Harness	\$291.50
B3028-375	Power Front Wheel Drive Harness (Optional, not included in above listed Complete Harness)	Replaces John Deere: #AR49479 Shift Speed Switch Harness; #AR4539 Extension Harness; #AR45734 Control Valve Harness; #AR49432 Clutch Switch Harness	\$238.00
B3028-398	Alternator Adapter Harness (Optional, not included in Complete Harness above)	Original Motorola Alternator to Delco 10SI Alternator Adaptor Assembly Harness (used when changing from Original Alternator to Delco 10SI { 3 wire } Alternator)	\$20.50

John Deere 4000 Diesel (Serial #222,919-250,000) with Power Shift Transmission

B3028-165	Complete Wire Harness Original Design with 12 Volt Alternator		\$1,299.75
------------------	---	--	-------------------

Includes Listed Components Below and Can Be Purchased Separately

B3028-156	Engine Harness	Replaces John Deere: #AR41686 Engine Harness, #AR47086 Relay Harness	\$286.25
B3028-157	Main Harness	Replaces John Deere: #AR41683, AR47855, AR49349, RE42185, RE42186 Main Harness	\$556.25
B3028-166	Instrument Harness	Replaces John Deere: #AR47857, RE61109, AR47858 Instrument, Filter Harness	\$222.50
B3028-159	Fender Lighting Harness	Replaces John Deere: #AR41684 Platform Harness; #AR41696 (2 Used) Head Light Harness; #AR41699 Rear Harness; #AR41695 Flasher Harness	\$291.50
B3028-375	Power Front Wheel Drive Harness (Optional, not included in above listed Complete Harness)	Replaces John Deere: #AR49479 Shift Speed Switch Harness; #AR4539 Extension Harness; #AR45734 Control Valve Harness; #AR49432 Clutch Switch Harness	\$238.00
B3028-398	Alternator Adapter Harness (Optional, not included in Complete Harness above)	Original Motorola Alternator to Delco 10SI Alternator Adaptor Assembly Harness (used when changing from Original Alternator to Delco 10SI { 3 wire } Alternator)	\$20.50

John Deere 4000 Diesel (Serial #250,001 & Up) with Synchro Range Transmission

B3028-248	Complete Wire Harness Original Design with 12 Volt Alternator		\$1,273.00
------------------	---	--	-------------------

Includes Listed Components Below and Can Be Purchased Separately

B3028-249	Engine Harness	Replaces John Deere: #AR52733 Engine Harness, #AR43609 Battery to Starter Relay	\$257.50
B3028-210	Main Harness	Replaces John Deere: #AR48936 Main Harness	\$560.25

Wiring Harnesses, Battery Cables, & Spark Plug Wires, Proudly Made in the USA!

B3028-211	Instrument Harness	Replaces John Deere: #AR43986 Instrument Harness	\$169.00
B3028-212	Fender Lighting Harness	Replaces John Deere: #AR41699, AR41702 Rear Harness; #AR48937 , Platform Harness; #AR48938 Fender Lamp Harness (2 Used); #AR50834 2 4-Light Adaptor Lead	\$291.50
B3028-411	Fender Lamp Harness	Replaces John Deere: #AR48938 Fender Lamp Harness (2 Used)- *Note: included with B3028-212 above	\$50.50
B3028-398	Alternator Adapter Harness (Optional, not included in Complete Harness above)	Original Motorola Alternator to Delco 10SI Alternator Adaptor Assembly Harness (used when changing from Original Alternator to Delco 10SI {3 wire} Alternator)	\$20.50

John Deere 4000 Diesel (Serial #250,001 & Up) with Power Shift Transmission

B3028-268	Complete Wire Harness Original Design with 12 Volt Alternator		\$1,332.75
------------------	---	--	-------------------

Includes Listed Components Below and Can Be Purchased Separately

B3028-249	Engine Harness	Replaces John Deere: #AR52733 Engine Harness, #AR43609 Battery to Starter Relay	\$257.50
B3028-210	Main Harness	Replaces John Deere: #AR48936 Main Harness	\$560.25
B3028-361	Instrument & Filter Harness	Replaces John Deere: #AR43987 Instrument Harness; #AR47858 Filter Harness	\$229.75
B3028-212	Fender Lighting Harness	Replaces John Deere: #AR41699, AR41702 Rear Harness; #AR48937 , Platform Harness; #AR48938 Fender Lamp Harness (2 Used); #AR50834 2 4-Light Adaptor Lead	\$291.50
B3028-411	Fender Lamp Harness	Replaces John Deere: #AR48938 Fender Lamp Harness (2 Used)- *Note: included with B3028-212 above	\$50.50
B3028-398	Alternator Adapter Harness (Optional, not included in Complete Harness above)	Original Motorola Alternator to Delco 10SI Alternator Adaptor Assembly Harness (used when changing from Original Alternator to Delco 10SI {3 wire} Alternator)	\$20.50

John Deere 4010 Gas Row Crop

Complete Wire Harness

B3028-106	Original Design with Generator		\$479.00
B3028-181	Modified for Use with a Replacement 12 Volt, 10SI Delco Alternator	*Note: May be used with a 1-Wire Alternator, except the Charge Indicator Lamp will not work.	\$479.00

Includes Listed Components Below and Can Be Purchased Separately

Dash & Engine Harness

B3028-167	Original Design with Generator	Replaces John Deere: #AR28808, AR26576, AR47657 Engine Harness; #AR28921 Neutral Safety Switch Harness	\$271.00
B3028-180	Modified For Use with a Replacement 12 Volt 10SI Delco Alternator	See B3028-167 above	\$271.00
B3028-101	Lighting Harness	Replaces John Deere: #AR26752 Switch to Fender Harness; #AR28289, AR26753 Switch to Rear Harness; #AR26575 Rear Harness; #AR27359 Fender Harness (2 Used); #AR27656 Starter to Rear harness (Has Fuse Holder)	\$210.00

John Deere 4010 Gas Standard

Complete Wire Harness

B3028-290	Original Design with Generator		\$398.50
B3028-296	Modified for Use with a Replacement 12 Volt, 10SI Delco Alternator	*Note: May be used with a 1-Wire Alternator, except the Charge Indicator Lamp will not work.	\$398.50

Includes Listed Components Below and Can Be Purchased Separately

Dash & Engine Harness

B3028-167	Original Design with Generator	Replaces John Deere: #AR28808, AR26576, AR47657 Engine Harness; #AR28921 Neutral Safety Switch Harness	\$271.00
B3028-180	Modified For Use With a Replacement 12 Volt 10SI Delco Alternator	See B3028-167 above	\$271.00
B3028-293	Lighting Harness	Replaces John Deere: #AR26616, AR28418, AR28419 Switch to Fender Harness; #AR28289, AR26753 Switch to Rear Harness; #AR26575 Rear Light Harness; #AR27239 Fender Harness (2 Used); #AR27656 Starter to Rear harness (Has Fuse Holder)	\$129.75

John Deere 4010 LP Row Crop

Complete Wire Harness

B3028-308	Original Design with Generator		\$479.00
B3028-424	Modified for Use with a 12 Volt, 10SI Delco Alternator		\$479.00

Includes Listed Components Below and Can Be Purchased Separately

Dash & Engine Harness

B3028-307	Original Design with Generator	Replaces John Deere: #AR28809, AR26577, AR47658 Engine Harness; #AR26565 Generator to Regulator Harness; #AR28921 Neutral Safety Switch Harness	\$271.00
B3028-421	Modified for Use with a 12 Volt, 10SI Delco Alternator	See B3028-307, above	\$271.00
B3028-101	Lighting Harness	Replaces John Deere: #AR26752 Switch to Fender Harness; #AR28289, AR26753 Switch to Rear Harness; #AR26575 Rear Harness; #AR27359 Fender Harness (2 Used); #AR27656 Starter to Rear harness (Has Fuse Holder)	\$210.00

John Deere 4010 Diesel Row Crop

Complete Wire Harness

B3028-107	Original Design with 24 Volt Generator		\$486.25
B3028-206	Modified for Use with a Replacement 12 Volt, 10SI Delco Alternator	*Note: May be used with a 1-Wire Alternator, except the Charge Indicator Lamp will not work.	\$486.25

Includes Listed Components Below and Can Be Purchased Separately

Dash & Engine Harness

B3028-108	Original Design with 24 Volt Generator	Replaces John Deere: #AR28810, AR47657 Engine Harness	\$284.25
B3028-205	Modified For Use With a Replacement 12 Volt 10SI Delco Alternator	Replaces John Deere: #AR28810, AR47657 Engine Harness	\$284.25
B3028-101	Lighting Harness	Replaces John Deere: #AR26752 Switch to Fender Harness; #AR28289, AR26753 Switch to Rear Harness; #AR26575 Rear Harness; #AR27359 Fender Harness (2 Used); #AR27656 Starter to Rear harness (Has Fuse Holder)	\$210.00

John Deere 4010 Diesel Standard

Complete Wire Harness

B3028-292	Original Design with 24 Volt Generator		\$404.75
B3028-297	Modified for Use with a Replacement 12 Volt, 10SI Delco Alternator	*Note: May be used with a 1-Wire Alternator, except the Charge Indicator Lamp will not work.	\$404.75

Includes Listed Components Below and Can Be Purchased Separately

Dash & Engine Harness

B3028-108	Original Design with 24 Volt Generator	Replaces John Deere: #AR28810, AR47657 Engine Harness	\$284.25
B3028-205	Modified For Use With a Replacement 12 Volt 10SI Delco Alternator	Replaces John Deere: #AR28810, AR47657 Engine Harness	\$284.25
B3028-293	Lighting Harness	Replaces John Deere: #AR26616, AR28418, AR28419 Switch to Fender Harness; #AR28289, AR26753 Switch to Rear Harness; #AR26575 Rear Light Harness; #AR27239 Fender Harness (2 Used); #AR27656 Starter to Rear harness (Has Fuse Holder)	\$129.75

John Deere 4020 Gas & LP Row Crop (Serial #65,000 to 90,999) with Synchro Range Transmission

Complete Wire Harness

B3028-428	Original Design with 12 Volt Generator		\$445.00
B3028-431	Modified For Use With a Replacement 10SI/ 3-Wire Delco Alternator		\$445.00

Includes Listed Components Below and Can Be Purchased Separately

Dash & Engine Harness

B3028-427	Original Design with 12 Volt Generator	Replaces John Deere: #AR47661, Sub for R34277 Dash & Engine Harness	\$269.75
B3028-430	Modified For Use With a Replacement 10SI/ 3-Wire Delco Alternator	See B3028-427 above	\$269.75
B3028-114	Neutral Safety Switch Harness	Replaces John Deere: #R33823 Neutral Safety Switch Harness	\$26.75
B3028-101	Lighting Harness	Replaces John Deere: #AR26752 Switch to Fender Harness; #AR28289, AR26753 Switch to Rear Harness; #AR26575 Rear Harness; #AR27359 Fender Harness (2 Used); #AR27656 Starter to Rear harness (Has Fuse Holder)	\$210.00

John Deere 4020 Gas & LP Row Crop (Serial #65,000 to 90,999) with Power Shift Transmission

Complete Wire Harness

B3028-432	Modified For Use With a Replacement 10SI/ 3-Wire Delco Alternator		\$457.25
------------------	---	--	-----------------

Includes Listed Components Below and Can Be Purchased Separately

Dash & Engine Harness

B3028-430	Modified For Use With a Replacement 10SI/ 3-Wire Delco Alternator	See B3028-427 above	\$269.75
B3028-115	Neutral Safety Switch Harness	Replaces John Deere: #R34869 Neutral Safety Switch Harness	\$41.25

Wiring Harnesses, Battery Cables, & Spark Plug Wires, Proudly Made in the USA!

B3028-101	Lighting Harness	Replaces John Deere: #AR26752 Switch to Fender Harness; #AR28289, AR26753 Switch to Rear Harness; #AR26575 Rear Harness; #AR27359 Fender Harness (2 Used); #AR27656 Starter to Rear harness (Has Fuse Holder)	\$210.00
------------------	-------------------------	--	-----------------

John Deere 4020 Gas & LP Row Crop (Serial #91,000 to #200,999) with Synchro Range Transmission Complete Wire Harness

B3028-313	Original Design with 12 Volt Generator		\$801.25
B3028-383	Modified For Use With a Replacement 12 Volt 10SI Delco Alternator		\$801.25

Includes Listed Components Below and Can Be Purchased Separately

Dash & Engine Harness

B3028-314	Original Design with 12 Volt Generator	Replaces John Deere: #AR47685, R39555, AR44952 Switch Harness; #AR47686, R39641, AR44953 Instrument Harness; #R39644, AR47663 Engine Harness	\$587.00
B3028-382	Modified For Use With a Replacement 12 Volt 10SI Delco Alternator	See B3028-314 above	\$587.00

B3028-114	Neutral Safety Switch Harness	Replaces John Deere: #R33823 <i>Neutral Safety Switch Harness</i>	\$26.75
B3028-113	Lighting Harness	Replaces John Deere: #AR41284 Platform Harness; #AR39618 Rear Harness; AR26575 Rear Harness; #AR27359 Fender Harness (2 Used)	\$217.25

John Deere 4020 Gas & LP Row Crop (Serial #91,000 to #200,999) with Power Shift Transmission Complete Wire Harness

B3028-370	Original Design with 12 Volt Generator		\$808.50
B3028-384	Modified For Use With a Replacement 12 Volt 10SI Delco Alternator		\$808.50

Includes Listed Components Below and Can Be Purchased Separately

Dash & Engine Harness

B3028-314	Original Design with 12 Volt Generator	Replaces John Deere: #AR47685, R39555, AR44952 Switch Harness; #AR47686, R39641, AR44953 Instrument Harness; #R39644, AR47663 Engine Harness	\$587.00
B3028-382	Modified For Use With a Replacement 12 Volt 10SI Delco Alternator	See B3028-314 above	\$587.00

B3028-115	Neutral Safety Switch Harness	Replaces John Deere: #R34869 <i>Neutral Safety Switch Harness</i>	\$41.25
B3028-113	Lighting Harness	Replaces John Deere: #AR41284 Platform Harness; #AR39618 Rear Harness; AR26575 Rear Harness; #AR27359 Fender Harness (2 Used)	\$217.25

John Deere 4020 Gas & LP Row Crop (Serial #201,000-250,000) With Synchro Range Transmission

B3028-389	Complete Wire Harness Original Design with 12 Volt Alternator		\$1,246.25
------------------	---	--	-------------------

Includes Listed Components Below and Can Be Purchased Separately

B3028-388	Engine Harness	Replaces John Deere: #AR41685 Engine Harness, AR47086 Relay Harness	\$300.75
B3028-157	Main Harness	Replaces John Deere: #AR41683, AR47855, AR49349, RE42185, RE42186 Main Harness	\$556.25
B3028-158	Instrument Harness	Replaces John Deere: #AR45516, AR47856, AR48647, RE42182, RE42183 Instrument Harness	\$182.25
B3028-159	Fender Lighting Harness	Replaces John Deere: #AR41684 Platform Harness; #AR41696 (2 Used) Head Light Harness; #AR41699 Rear Harness; #AR41695 Flasher Harness	\$291.50
B3028-398	Alternator Adapter Harness (Optional, not included in Complete Harness above)	Original Motorola Alternator to Delco 10SI Alternator Adaptor Assembly Harness (used when changing from Original Alternator to Delco 10SI {3 wire} Alternator)	\$20.50

John Deere 4020 Gas & LP (Serial #201,000-222,918) with Power Shift Transmission

B3028-390	Complete Wire Harness Original Design with 12 Volt Alternator		\$1,313.25
------------------	---	--	-------------------

Includes Listed Components Below and Can Be Purchased Separately

B3028-388	Engine Harness	Replaces John Deere: #AR41685 Engine Harness, AR47086 Relay Harness	\$300.75
B3028-157	Main Harness	Replaces John Deere: #AR41683, AR47855, AR49349, RE42185, RE42186 Main Harness	\$556.25
B3028-222	Instrument Harness	Replaces John Deere: #AR45517, AR48647, AR46728, AR46729, Instrument Harness	\$243.00
B3028-159	Fender Lighting Harness	Replaces John Deere: #AR41684 Platform Harness; #AR41696 (2 Used) Head Light Harness; #AR41699 Rear Harness; #AR41695 Flasher Harness	\$291.50

Wiring Harnesses, Battery Cables, & Spark Plug Wires, Proudly Made in the USA!

B3028-375	Power Front Wheel Drive Harness (Optional, not included in above listed Complete Harness)	Replaces John Deere: #AR49479 Shift Speed Switch Harness; #AR4539 Extension Harness; #AR45734 Control Valve Harness; #AR49432 Clutch Switch Harness	\$238.00
B3028-398	Alternator Adapter Harness (Optional, not included in Complete Harness above)	Original Motorola Alternator to Delco 10SI Alternator Adaptor Assembly Harness (used when changing from Original Alternator to Delco 10SI {3 wire} Alternator)	\$20.50

John Deere 4020 Gas, & LP (Serial #222, 919-250,000) with Power Shift Transmission

B3028-391	Complete Wire Harness Original Design with 12 Volt Alternator		\$1,313.25
------------------	---	--	-------------------

Includes Listed Components Below and Can Be Purchased Separately

B3028-388	Engine Harness	Replaces John Deere: #AR41685 Engine Harness, AR47086 Relay Harness	\$300.75
B3028-157	Main Harness	Replaces John Deere: #AR41683, AR47855, AR49349, RE42185, RE42186 Main Harness	\$556.25
B3028-166	Instrument Harness	Replaces John Deere: #AR47857, RE61109, AR47858 Instrument, Filter Harness	\$222.50
B3028-159	Fender Lighting Harness	Replaces John Deere: #AR41684 Platform Harness; #AR41696 (2 Used) Head Light Harness; #AR41699 Rear Harness; #AR41695 Flasher Harness	\$291.50
B3028-375	Power Front Wheel Drive Harness (Optional, not included in above listed Complete Harness)	Replaces John Deere: #AR49479 Shift Speed Switch Harness; #AR4539 Extension Harness; #AR45734 Control Valve Harness; #AR49432 Clutch Switch Harness	\$238.00
B3028-398	Alternator Adapter Harness (Optional, not included in Complete Harness above)	Original Motorola Alternator to Delco 10SI Alternator Adaptor Assembly Harness (used when changing from Original Alternator to Delco 10SI {3 wire} Alternator)	\$20.50

John Deere 4020 Gas & LP (Serial #250,001 & Up) with Synchro Range Transmission

B3028-208	Complete Wire Harness Original Design with 12 Volt Alternator		\$1,285.50
------------------	---	--	-------------------

Includes Listed Components Below and Can Be Purchased Separately

B3028-209	Engine Harness	Replaces John Deere: #AR50827 Engine Harness	\$271.00
B3028-210	Main Harness	Replaces John Deere: #AR48936 Main Harness	\$560.25
B3028-211	Instrument Harness	Replaces John Deere: #AR43986 Instrument Harness	\$169.00
B3028-212	Fender Lighting Harness	Replaces John Deere: #AR41699, AR41702 Rear Harness; #AR48937, Platform Harness; #AR48938 Fender Lamp Harness (2 Used); #AR50834 2 4-Light Adaptor Lead	\$291.50
B3028-411	Fender Lamp Harness	Replaces John Deere: #AR48938 Fender Lamp Harness (2 Used)- *Note: included with B3028-212 above	\$50.50
B3028-398	Alternator Adapter Harness (Optional, not included in Complete Harness above)	Original Motorola Alternator to Delco 10SI Alternator Adaptor Assembly Harness (used when changing from Original Alternator to Delco 10SI {3 wire} Alternator)	\$20.50

John Deere 4020 Gas & LP (Serial #250,001 & Up) with Power Shift Transmission

B3028-269	Complete Wire Harness Original Design with 12 Volt Alternator		\$1,340.00
------------------	---	--	-------------------

Includes Listed Components Below and Can Be Purchased Separately

B3028-209	Engine Harness	Replaces John Deere: #AR50827 Engine Harness	\$271.00
B3028-210	Main Harness	Replaces John Deere: #AR48936 Main Harness	\$560.25
B3028-361	Instrument & Filter Harness	Replaces John Deere: #AR43987 Instrument Harness; #AR47858 Filter Harness	\$229.75
B3028-212	Fender Lighting Harness	Replaces John Deere: #AR41699, AR41702 Rear Harness; #AR48937, Platform Harness; #AR48938 Fender Lamp Harness (2 Used); #AR50834 2 4-Light Adaptor Lead	\$291.50
B3028-411	Fender Lamp Harness	Replaces John Deere: #AR48938 Fender Lamp Harness (2 Used)- *Note: included with B3028-212 above	\$50.50
B3028-398	Alternator Adapter Harness (Optional, not included in Complete Harness above)	Original Motorola Alternator to Delco 10SI Alternator Adaptor Assembly Harness (used when changing from Original Alternator to Delco 10SI {3 wire} Alternator)	\$20.50

John Deere 4020 Diesel Row Crop (Up to Serial #90,999) with Synchro Range Transmission

Complete Wire Harness

B3028-147	Original Design with 24 Volt Generator		\$474.75
------------------	--	--	-----------------

Wiring Harnesses, Battery Cables, & Spark Plug Wires, Proudly Made in the USA!

B3028-150	Modified for Use with a Replacement 12 Volt, 10SI Delco Alternator	*Note: May be used with a 1-Wire Alternator, except the Charge Indicator Lamp will not work.	\$474.75
------------------	--	---	-----------------

Includes Listed Components Below and Can Be Purchased Separately

Dash & Engine Harness

B3028-148	Original Design with 24 Volt Generator	Replaces John Deere: #AR34278, AR47660 Main Harness (Dash & Engine)	\$267.75
B3028-152	Modified For Use With a Replacement 12 Volt 10SI Delco Alternator	Replaces John Deere: #AR34278, AR47660 Main Harness (Dash & Engine)	\$267.75
B3028-114	Neutral Safety Switch Harness	Replaces John Deere: #R33823 Neutral Safety Switch Harness	\$26.75
B3028-101	Lighting Harness	Replaces John Deere: #AR26752 Switch to Fender Harness; #AR28289, AR26753 Switch to Rear Harness; #AR26575 Rear Harness; #AR27359 Fender Harness (2 Used); #AR27656 Starter to Rear harness (Has Fuse Holder)	\$210.00

John Deere 4020 Diesel Row Crop (Up to Serial #75,534) with Power Shift Transmission

Complete Wire Harness

B3028-386	Original Design with 24 Volt Generator		\$486.25
B3028-387	Modified for Use with a Replacement 12 Volt, 10SI Delco Alternator	*Note: May be used with a 1-Wire Alternator, except the Charge Indicator Lamp will not work.	\$486.25

Includes Listed Components Below and Can Be Purchased Separately

Dash & Engine Harness

B3028-148	Original Design with 24 Volt Generator	Replaces John Deere: #AR34278, AR47660 Main Harness (Dash & Engine)	\$267.75
B3028-152	Modified For Use With a Replacement 12 Volt 10SI Delco Alternator	Replaces John Deere: #AR34278, AR47660 Main Harness (Dash & Engine)	\$267.75
B3028-193	Neutral Safety Switch Harness	Replaces John Deere: #R33770 Neutral Safety Switch Harness	\$22.75
B3028-101	Lighting Harness	Replaces John Deere: #AR26752 Switch to Fender Harness; #AR28289, AR26753 Switch to Rear Harness; #AR26575 Rear Harness; #AR27359 Fender Harness (2 Used); #AR27656 Starter to Rear harness (Has Fuse Holder)	\$210.00

John Deere 4020 Diesel Row Crop (Serial #75,535 to 90,999) with Power Shift Transmission

Complete Wire Harness

B3028-145	Original Design with 24 Volt Generator		\$486.25
B3028-153	Modified for Use with a Replacement 12 Volt, 10SI Delco Alternator	*Note: May be used with a 1-Wire Alternator, except the Charge Indicator Lamp will not work.	\$486.25

Includes Listed Components Below and Can Be Purchased Separately

Dash & Engine Harness

B3028-148	Original Design with 24 Volt Generator	Replaces John Deere: #AR34278, AR47660 Main Harness (Dash & Engine)	\$267.75
B3028-152	Modified For Use With a Replacement 12 Volt 10SI Delco Alternator	Replaces John Deere: #AR34278, AR47660 Main Harness (Dash & Engine)	\$267.75
B3028-115	Neutral Safety Switch Harness	Replaces John Deere: #R34869 Neutral Safety Switch Harness	\$41.25
B3028-101	Lighting Harness	Replaces John Deere: #AR26752 Switch to Fender Harness; #AR28289, AR26753 Switch to Rear Harness; #AR26575 Rear Harness; #AR27359 Fender Harness (2 Used); #AR27656 Starter to Rear harness (Has Fuse Holder)	\$210.00

John Deere 4020 Diesel Row Crop (Serial #91,000 to 200,999) with Synchro Range Transmission

Complete Wire Harness

B3028-111	Original Design with 24 Volt Generator		\$801.25
B3028-140	Modified For Use With a Replacement 12 Volt 10SI Delco Alternator	*Note: May be used with a 1-Wire Alternator, except the Charge Indicator Lamp will not work.	\$801.25

Includes Listed Components Below and Can Be Purchased Separately

Engine & Dash Harness

B3028-118	Original Design with 24 Volt Generator	Replaces John Deere: #AR47685, R39555, AR44952 Switch Harness; #AR47686, R39641, AR44953 Instrument Harness; #AR44954, R39645, AR47662 Engine Harness	\$601.50
B3028-139	Modified For Use With a Replacement 12 Volt 10SI Delco Alternator	Replaces John Deere: #AR47685, R39555, AR44952 Switch Harness; #AR47686, R39641, AR44953 Instrument Harness; #AR44954, R39645, AR47662 Engine Harness	\$601.50

B3028-114	Neutral Safety Switch Harness	Replaces John Deere: #R33823 Neutral Safety Switch Harness	\$26.75
B3028-113	Lighting Harness	Replaces John Deere: #AR41284 Platform Harness; #AR39618 Rear Harness; AR26575 Rear Harness; #AR27359 Fender Harness (2 Used)	\$217.25

John Deere 4020 Diesel Row Crop (Serial #91,000 to 200,999) with Power Shift Transmission
Complete Wire Harness

B3028-116	Original Design with 24 Volt Generator		\$814.75
B3028-141	Modified for Use with a Replacement 12 Volt, 10SI Delco Alternator	*Note: May be used with a 1-Wire Alternator, except the Charge Indicator Lamp will not work.	\$814.75

Includes Listed Components Below and Can Be Purchased Separately

Engine & Dash Harness

B3028-118	Original Design with 24 Volt Generator	Replaces John Deere: #AR47685, R39555, AR44952 Switch Harness; #AR47686, R39641, AR44953 Instrument Harness; #AR44954, R39645, AR47662 Engine Harness	\$601.50
B3028-139	Modified For Use With a Replacement 12 Volt 10SI Delco Alternator	Replaces John Deere: #AR47685, R39555, AR44952 Switch Harness; #AR47686, R39641, AR44953 Instrument Harness; #AR44954, R39645, AR47662 Engine Harness	\$601.50
B3028-115	Neutral Safety Switch Harness	Replaces John Deere: #R34869 Neutral Safety Switch Harness	\$41.25
B3028-113	Lighting Harness	Replaces John Deere: #AR41284 Platform Harness; #AR39618 Rear Harness; AR26575 Rear Harness; #AR27359 Fender Harness (2 Used)	\$217.25

John Deere 4020 Diesel High Crop (Serial #91,000 to 200,999) with Synchro Range Transmission
Complete Wire Harness

B3028-219	Original Design with 24 Volt Generator		\$781.75
B3028-339	Modified for Use with a Replacement 12 Volt, 10SI Delco Alternator	*Note: May be used with a 1-Wire Alternator, except the Charge Indicator Lamp will not work.	\$781.75

Includes Listed Components Below and Can Be Purchased Separately

Engine & Dash Harness

B3028-118	Original Design with 24 Volt Generator	Replaces John Deere: #AR47685, R39555, AR44952 Switch Harness; #AR47686, R39641, AR44953 Instrument Harness; #AR44954, R39645, AR47662 Engine Harness	\$601.50
B3028-139	Modified For Use With a Replacement 12 Volt 10SI Delco Alternator	Replaces John Deere: #AR47685, R39555, AR44952 Switch Harness; #AR47686, R39641, AR44953 Instrument Harness; #AR44954, R39645, AR47662 Engine Harness	\$601.50
B3028-114	Neutral Safety Switch Harness	Replaces John Deere: #R33823 Neutral Safety Switch Harness	\$26.75
B3028-220	Lighting Harness	Replaces John Deere: #AR41284 Platform Harness; #AR39618 Rear Harness; #AR27359, AR26575 Rear Harness #R66319, R32016, R32025, R32027 Head Light Lead (2 Used)	\$196.75

John Deere 4020 Diesel (Serial #201,000-250,000) with Synchro Range Transmission

B3028-155	Complete Wire Harness Original Design with 12 Volt Alternator		\$1,233.00
------------------	---	--	-------------------

Includes Listed Components Below and Can Be Purchased Separately

B3028-156	Engine Harness	Replaces John Deere: #AR41686 Engine Harness, AR47086 Relay Harness	\$286.25
B3028-157	Main Harness	Replaces John Deere: #AR41683, AR47855, AR49349, RE42185, RE42186 Main Harness	\$556.25
B3028-158	Instrument Harness	Replaces John Deere: #AR45516, AR47856, AR48647, RE42182, RE42183 Instrument Harness	\$182.25
B3028-159	Fender Lighting Harness	Replaces John Deere: #AR41684 Platform Harness; #AR41696 (2 Used) Head Light Harness; #AR41699 Rear Harness; #AR41695 Flasher Harness	\$291.50
B3028-398	Alternator Adapter Harness (Optional, not included in Complete Harness above)	Original Motorola Alternator to Delco 10SI Alternator Adaptor Assembly Harness (used when changing from Original Alternator to Delco 10SI {3 wire} Alternator)	\$20.50

John Deere 4020 Diesel (Serial #201,000-222,918) with Power Shift Transmission

B3028-221	Complete Wire Harness Original Design with 12 Volt Alternator		\$1,299.75
------------------	---	--	-------------------

Wiring Harnesses, Battery Cables, & Spark Plug Wires, Proudly Made in the USA!

Includes Listed Components Below and Can Be Purchased Separately

B3028-156	Engine Harness	Replaces John Deere: #AR41686 Engine Harness, AR47086 Relay Harness	\$286.25
B3028-157	Main Harness	Replaces John Deere: #AR41683, AR47855, AR49349, RE42185, RE42186 Main Harness	\$556.25
B3028-222	Instrument Harness	Replaces John Deere: #AR45517, AR48647, AR46728, AR46729, Instrument Harness	\$243.00
B3028-159	Fender Lighting Harness	Replaces John Deere: #AR41684 Platform Harness; #AR41696 (2 Used) Head Light Harness; #AR41699 Rear Harness; #AR41695 Flasher Harness	\$291.50
B3028-375	Power Front Wheel Drive Harness (Optional, not included in above listed Complete Harness)	Replaces John Deere: #AR49479 Shift Speed Switch Harness; #AR4539 Extension Harness; #AR45734 Control Valve Harness; #AR49432 Clutch Switch Harness	\$238.00
B3028-398	Alternator Adapter Harness (Optional, not included in Complete Harness above)	Original Motorola Alternator to Delco 10SI Alternator Adaptor Assembly Harness (used when changing from Original Alternator to Delco 10SI {3 wire} Alternator)	\$20.50

John Deere 4020 Diesel (Serial #222,919-250,000) with Power Shift Transmission

B3028-165	Complete Wire Harness Original Design with 12 Volt Alternator		\$1,299.75
------------------	---	--	-------------------

Includes Listed Components Below and Can Be Purchased Separately

B3028-156	Engine Harness	Replaces John Deere: #AR41686 Engine Harness, AR47086 Relay Harness	\$286.25
B3028-157	Main Harness	Replaces John Deere: #AR41683, AR47855, AR49349, RE42185, RE42186 Main Harness	\$556.25
B3028-166	Instrument & Filter Harness	Replaces John Deere: #AR47857, RE61109, AR47858 Instrument, Filter Harness	\$222.50
B3028-159	Fender Lighting Harness	Replaces John Deere: #AR41684 Platform Harness; #AR41696 (2 Used) Head Light Harness; #AR41699 Rear Harness; #AR41695 Flasher Harness	\$291.50
B3028-375	Power Front Wheel Drive Harness (Optional, not included in above listed Complete Harness)	Replaces John Deere: #AR49479 Shift Speed Switch Harness; #AR4539 Extension Harness; #AR45734 Control Valve Harness; #AR49432 Clutch Switch Harness	\$238.00
B3028-398	Alternator Adapter Harness (Optional, not included in Complete Harness above)	Original Motorola Alternator to Delco 10SI Alternator Adaptor Assembly Harness (used when changing from Original Alternator to Delco 10SI {3 wire} Alternator)	\$20.50

John Deere 4020 Diesel (Serial #250,001 & Up) with Synchro Range Transmission

B3028-248	Complete Wire Harness Original Design with 12 Volt Alternator		\$1,273.00
------------------	---	--	-------------------

Includes Listed Components Below and Can Be Purchased Separately

B3028-249	Engine Harness	Replaces John Deere: #AR52733 Engine Harness, #AR43609 Battery to Starter Relay	\$257.50
B3028-210	Main Harness	Replaces John Deere: #AR48936 Main Harness	\$560.25
B3028-211	Instrument Harness	Replaces John Deere: #AR43986 Instrument Harness	\$169.00
B3028-212	Fender Lighting Harness	Replaces John Deere: #AR41699, AR41702 Rear Harness; #AR48937, Platform Harness; #AR48938 Fender Lamp Harness (2 Used); #AR50834 2 4-Light Adaptor Lead	\$291.50
B3028-411	Fender Lamp Harness	Replaces John Deere: #AR48938 Fender Lamp Harness (2 Used)- *Note: included with B3028-212 above	\$50.50
B3028-398	Alternator Adapter Harness (Optional, not included in Complete Harness above)	Original Motorola Alternator to Delco 10SI Alternator Adaptor Assembly Harness (used when changing from Original Alternator to Delco 10SI {3 wire} Alternator)	\$20.50

John Deere 4020 Diesel (Serial #250,001 & Up) with Power Shift Transmission

B3028-268	Complete Wire Harness Original Design with 12 Volt Alternator		\$1,332.75
------------------	---	--	-------------------

Includes Listed Components Below and Can Be Purchased Separately

B3028-249	Engine Harness	Replaces John Deere: #AR52733 Engine Harness, #AR43609 Battery to Starter Relay	\$257.50
B3028-210	Main Harness	Replaces John Deere: #AR48936 Main Harness	\$560.25
B3028-361	Instrument & Filter Harness	Replaces John Deere: #AR43987 Instrument Harness; #AR47858 Filter Harness	\$229.75
B3028-212	Fender Lighting Harness	Replaces John Deere: #AR41699, AR41702 Rear Harness; #AR48937, Platform Harness; #AR48938 Fender Lamp Harness (2 Used); #AR50834 2 4-Light Adaptor Lead	\$291.50

B3028-411	Fender Lamp Harness	Replaces John Deere: #AR48938 Fender Lamp Harness (2 Used)- *Note: included with B3028-212 above	\$50.50
B3028-398	Alternator Adapter Harness (Optional, not included in Complete Harness above)	Original Motorola Alternator to Delco 10SI Alternator Adaptor Assembly Harness (used when changing from Original Alternator to Delco 10SI {3 wire} Alternator)	\$20.50

John Deere 4030 Gas

B3028-416	Engine Harness	Replaces John Deere: #AR63866 Engine Harness	\$274.00
------------------	-----------------------	---	-----------------

John Deere 4040, 4240 (Open Station)

B3028-451	Engine Harness (also fits Open Station 4030, 4230, 4430, 4440)	Replaces: #AR95905, AR99520, AR99523, RE13559, RE14060, RE14062, R42395	\$275.00
B3028-452	Engine-to-Lighting Harness	Replaces: #AR84124	\$180.00
B3028-453	Right Side Lighting Harness	Replaces: #AR84123, AR88953	\$90.00
B3028-454	Left Side Lighting Harness	Replaces: #AR88954	\$90.00

John Deere 4320 Diesel Row Crop

B3028-359	Complete Wire Harness Original Design with Motorola Alternator	(for Delco 10SI Alternators, see B3028-398 below)	\$1,273.00
------------------	--	--	-------------------

Includes Listed Components Below and Can Be Purchased Separately

B3028-317	Engine Harness	Replaces John Deere: #AR50913 Engine Harness; #AR43609 Battery to Starter Relay	\$257.50
B3028-210	Main Harness	Replaces John Deere: #AR48936 Main Harness	\$560.25
B3028-211	Instrument Harness	Replaces John Deere: #AR43986 Instrument Harness	\$169.00
B3028-212	Fender Lighting Harness	Replaces John Deere: #AR41699, AR41702 Rear Harness; #AR48937, Platform Harness; #AR48938 Fender Lamp Harness (2 Used); #AR50834 2 4-Light Adaptor Lead	\$291.50
B3028-411	Fender Lamp Harness	Replaces John Deere: #AR48938 Fender Lamp Harness (2 Used)- *Note: included with B3028-212 above	\$50.50
B3028-398	Alternator Adapter Harness (Optional, not included in Complete Harness above)	Original Motorola Alternator to Delco 10SI Alternator Adaptor Assembly Harness (used when changing from Original Alternator to Delco 10SI {3 wire} Alternator)	\$20.50

John Deere 4520 Diesel (Up to Serial #7127) with Synchro Range Transmission

B3028-377	Complete Wire Harness Original Design with Motorola Alternator		\$1,239.00
------------------	--	--	-------------------

Includes Listed Components Below and Can Be Purchased Separately

B3028-376	Engine Harness	Replaces John Deere: #AR43159 Engine Harness; #AR43609 Battery to Starter Relay	\$274.00
B3028-157	Main Harness	Replaces John Deere: #AR41683, AR47855, AR49349, RE42185, RE42186 Main Harness	\$556.25
B3028-158	Instrument Harness	Replaces John Deere: #AR45516, AR47856, AR48647, RE42182, RE42183 Instrument Harness	\$182.25
B3028-159	Fender Lighting Harness	Replaces John Deere: #AR41684 Platform Harness; #AR41696 (2 Used) Head Light Harness; #AR41699 Rear Harness; #AR41695 Flasher Harness	\$291.50
B3028-398	Alternator Adapter Harness (Optional, not included in Complete Harness above)	Original Motorola Alternator to Delco 10SI Alternator Adaptor Assembly Harness (used when changing from Original Alternator to Delco 10SI {3 wire} Alternator)	\$20.50

John Deere 4520 Diesel (Up to Serial #7127) with Power Shift Transmission

B3028-378	Complete Wire Harness Original Design with Motorola Alternator		\$1,299.75
------------------	--	--	-------------------

Includes Listed Components Below and Can Be Purchased Separately

-(Has the Same Components as #B3028-377 above, except for the Instrument Harness)

B3028-222	Instrument Harness	Replaces John Deere: #AR45517, AR48647, AR46728, AR46729, Instrument Harness	\$243.00
------------------	---------------------------	--	-----------------

John Deere 4520 Diesel (Serial #7128 & Up) With Synchro Range Transmission

B3028-318	Complete Wire Harness Original Design with Motorola Alternator		\$1,273.00
------------------	--	--	-------------------

Includes Listed Components Below and Can Be Purchased Separately

B3028-317	Engine Harness	Replaces John Deere: #AR50914 Engine Harness; #AR43609 Battery to Starter Relay	\$257.50
B3028-210	Main Harness	Replaces John Deere: #AR48936 Main Harness	\$560.25
B3028-211	Instrument Harness	Replaces John Deere: #AR43986 Instrument Harness	\$169.00
B3028-212	Fender Lighting Harness	Replaces John Deere: #AR41699, AR41702 Rear Harness; #AR48937, Platform Harness; #AR48938 Fender Lamp Harness (2 Used); #AR50834 2 4-Light Adaptor Lead	\$291.50
B3028-411	Fender Lamp Harness	Replaces John Deere: #AR48938 Fender Lamp Harness (2 Used)- *Note: included with B3028-212 above	\$50.50
B3028-398	Alternator Adapter Harness (Optional, not included in Complete Harness above)	Original Motorola Alternator to Delco 10SI Alternator Adaptor Assembly Harness (used when changing from Original Alternator to Delco 10SI {3 wire} Alternator)	\$20.50

John Deere 4520 Diesel (Serial #7128 & Up) with Power Shift Transmission

B3028-379	Complete Wire Harness Original Design with Motorola Alternator		\$1,332.75
------------------	--	--	-------------------

Includes Listed Components Below and Can Be Purchased Separately

B3028-317	Engine Harness	Replaces John Deere: #AR50914 Engine Harness; #AR43609 Battery to Starter Relay	\$257.50
B3028-210	Main Harness	Replaces John Deere: #AR48936 Main Harness	\$560.25
B3028-361	Instrument & Filter Harness	Replaces John Deere: #AR43987 Instrument Harness; #AR47858 Filter Harness	\$229.75
B3028-212	Fender Lighting Harness	Replaces John Deere: #AR41699, AR41702 Rear Harness; #AR48937, Platform Harness; #AR48938 Fender Lamp Harness (2 Used); #AR50834 2 4-Light Adaptor Lead	\$291.50
B3028-411	Fender Lamp Harness	Replaces John Deere: #AR48938 Fender Lamp Harness (2 Used)- *Note: included with B3028-212 above	\$50.50
B3028-398	Alternator Adapter Harness (Optional, not included in Complete Harness above)	Original Motorola Alternator to Delco 10SI Alternator Adaptor Assembly Harness (used when changing from Original Alternator to Delco 10SI {3 wire} Alternator)	\$20.50

John Deere 4620 Diesel with Synchro Range Transmission

B3028-407	Complete Wire Harness Original Design with Motorola Alternator		\$1,273.00
------------------	--	--	-------------------

Includes Listed Components Below and Can Be Purchased Separately

B3028-317	Engine Harness	Replaces John Deere: #AR50914 Engine Harness; #AR43609 Battery to Starter Relay	\$257.50
B3028-210	Main Harness	Replaces John Deere: #AR48936 Main Harness	\$560.25
B3028-211	Instrument Harness	Replaces John Deere: #AR43986 Instrument Harness	\$169.00
B3028-212	Fender Lighting Harness	Replaces John Deere: #AR41699, AR41702 Rear Harness; #AR48937, Platform Harness; #AR48938 Fender Lamp Harness (2 Used); #AR50834 2 4-Light Adaptor Lead	\$291.50
B3028-411	Fender Lamp Harness *Note: included with B3028-212 above	Replaces John Deere: #AR48938 Fender Lamp Harness (2 Used)-	\$50.50
B3028-398	Alternator Adapter Harness (Optional, not included in Complete Harness above)	Original Motorola Alternator to Delco 10SI Alternator Adaptor Assembly Harness (used when changing from Original Alternator to Delco 10SI {3 wire} Alternator)	\$20.50

John Deere 4620 Diesel with Power Shift Transmission

B3028-408	Complete Wire Harness Original Design with Motorola Alternator		\$1,332.75
------------------	--	--	-------------------

Includes Listed Components Below and Can Be Purchased Separately

B3028-317	Engine Harness	Replaces John Deere: #AR50914 Engine Harness; #AR43609 Battery to Starter Relay	\$257.50
B3028-210	Main Harness	Replaces John Deere: #AR48936 Main Harness	\$560.25
B3028-361	Instrument & Filter Harness	Replaces John Deere: #AR43987 Instrument Harness; #AR47858 Filter Harness	\$229.75
B3028-212	Fender Lighting Harness	Replaces John Deere: #AR41699, AR41702 Rear Harness; #AR48937, Platform Harness; #AR48938 Fender Lamp Harness (2 Used); #AR50834 2 4-Light Adaptor Lead	\$291.50
B3028-411	Fender Lamp Harness	Replaces John Deere: #AR48938 Fender Lamp Harness (2 Used)- *Note: included with B3028-212 above	\$50.50
B3028-398	Alternator Adapter Harness (Optional, not included in Complete Harness above)	Original Motorola Alternator to Delco 10SI Alternator Adaptor Assembly Harness (used when changing from Original Alternator to Delco 10SI {3 wire} Alternator)	\$20.50

John Deere 5010 Diesel (Up to Serial #4499)

Complete Wire Harness

B3028-285	Original Design with 24 Volt Generator		\$701.50
B3028-287	Modified for Use with a Replacement 12 Volt, 10SI Delco Alternator	*Note: May be used with a 1-Wire Alternator, except the Charge Indicator Lamp will not work.	\$701.50

Includes Listed Components Below and Can Be Purchased Separately

Main Harness

B3028-286	Original Design with 24 Volt Generator	Replaces John Deere: #AR47688 Main Harness	\$384.25
B3028-284	Modified for Use with a Replacement 12 Volt, 10SI Delco Alternator	Replaces John Deere: #AR47688 Main Harness	\$384.25
B3028-283	Lighting Harness	Replaces John Deere: #AR35651 Switch to Platform Harness; #AR36292 Platform Harness; #AR26575 Rear Light Harness; #AR39661 Fender Harness (2 Used); #AT12928 Aux Socket Lead with fuse Holder	\$318.25

John Deere 5020 Diesel Standard (Up to Serial #24,999)

Complete Wire Harness

B3028-442	Original Design with 24-Volt Motorola Alternator		\$904.25
B3028-443	Modified for 12-Volt Delco 10SI (3-Wire) Alternator		\$904.25

Includes Listed Components Below and Can Be Purchased Separately

Engine & Dash Harness

B3028-392	Original Design with 24 Volt Motorola Alternator	Replaces John Deere: #AR47685, R39555, AR44952 Switch Harness; #AR47686, R39641, AR44953 Instrument Harness; # AR47706 Engine Harness	\$695.25
B3028-417	Modified for 12 Volt Delco 10SI (3 Wire) Alternator	Replaces John Deere: #AR47685, R39555, AR44952 Switch Harness; #AR47686, R39641, AR44953 Instrument Harness; # AR47706 Engine Harness *Note: May be used with a 1-Wire Alternator, except the Charge Indicator Lamp will not work.	\$695.25
B3028-441	Neutral Safety Switch Hanress	Replaces John Deere: #AR36975, AR39662 Switch Harness	\$26.75
B3028-385	Standard Lighting Wire Harness	Replaces John Deere: #AR41284 Platform Harness; #R396662 Rear Harness #R39661 Head light Fender Harness (2 Used)	\$229.75

John Deere Platform Harness (various fits)

B3028-419	Platform Harness	Replaces John Deere: #AR41284 Platform Harness	\$189.50
------------------	-------------------------	---	-----------------

Note

When ordering, please specify **Year** or **Serial Number**, Magneto/Distributor, & Regulator/Cut Out Relay.
Some Harnesses were originally made with PVC Wire & Braided; others were made with PVC Wire & Taped.
In those cases, we build them the **Original Way**.

WIRE HARNESS ACCESSORIES

B9027-003	Wiring Cover	\$17.99
	John Deere *Call for Availability* Fits John Deere 520, 530 (Must Be Cut To Length for 620, 630, 720, & 730) 11 3/4" Length, 3/4" Width Used When Equipped With Flat-Top Fenders & Lights, Attaches Wiring Harness to Rear Axle Housing * 2 used per tractor; each sold individually Replaces: AR20871R, AR20932R	

TUNE UP PARTS (WITH DISTRIBUTOR)

John Deere A, B, G, 50 with replacement Delco Distributor #1111558		
	B4100-002	\$10.50
	PCR Kit Includes: Points (#B4001-001), Condenser (#B4002-003), Rotor (#B4004-002) Replaces: Points - #D100HP, 1855720 Condenser - #1928111, D203 Rotor - #820445, D400	
	B4004-002	\$5.75
	Rotor Replaces: #820445, D400	
	B4003-016	\$26.75
	Distributor Cap Premium Grade, Made in the USA (Brass Contacts) Replaces: #1913739	
	B4006-001	\$9.99
	Dust Cover Replaces: #1900119	
	B4007-001	\$11.95
	Cap Clip Short Mount, 1 Used Replaces: #1889967, 1847289, 453844, 453461	
	B4007-002	\$11.95
	Cap Clip Long Mount, 1 Used Replaces: #1889967, 1889999, 453844, 453461	
	B4008-001	\$14.99
	Distributor Insulator Replaces: #1904376	
	B4009-002	\$24.99
	Distributor Bushing & Shim Kit	
	B4008-012	\$6.25
	Delco Advance Spring Replaces: #1912765	

*For 6- or 12-Volt Ignition Coils & Accessories, see p.44

John Deere A, B, G, 50 (with Battery Ignition) with WICO Distributors #XB4001L, XB4023B		
	B4011-004	\$17.75
	Points Replaces: #1-5008, 1-5111, FXH-2100B, FXH-2400B, X5996, AR12014	

	B4002-004	\$11.00
	Condenser Replaces: #90-5072	
	B4013-007	\$20.25
	B4013-040 (with Logo)	\$29.75
	Cap Used with 2-Ear Rotor *Includes Gasket Replaces: #3-5000, X5643, FXH2101-2	
	B4004-014	\$13.00
	Rotor 2-Ear Rotor (Used with # B4013-007 Cap) Replaces: #4-5003, X5617, AR31318	
	B4015-004	\$68.50
	Call for Availability Coil Replaces: #5-5093	
	B4016-004	\$2.25
	Cap Gasket Replaces: #94-5076	
	B4017-016	\$10.50
	Call for Availability Coil Clamp 2 Used, Each Sold Separately Replaces: #6845	
	B4017-017	\$12.50
	WICO XB Coil Bar Set Replaces: #94-5109	
	B4016-005	\$1.75
	Flange Gasket Replaces: #SAE	
	B4017-018	\$43.50
	Advance Spring 2 Used, Each Sold Separately Replaces: #6839	
	B4017-047	\$24.75
	Resistor Coil Wire For 12-Volt WICO XB Distributors Only	
	B4017-019	\$29.75
	Resistor Wire Under Cover Replaces: #6822	

John Deere 60, 70 Gas with Delco Distributor #1111558		
	B4100-002	\$10.50
	PCR Kit Includes: Points (#B4001-001), Condenser (#B4002-003), Rotor (#B4004-002) Replaces: Points - #D100HP, 1855720 Condenser - #1928111, D203 Rotor - #820445, D400	
	B4004-002	\$5.75
	Rotor Replaces: #820445, D400	
	B4003-016	\$26.75
	Distributor Cap Premium Grade, Made in the USA (Brass Contacts) Replaces: #1913739	
	B4006-001	\$9.99
	Dust Cover Replaces: #1900119	
	B4007-001	\$11.95
	Cap Clip Short Mount, 1 Used Replaces: #1889967, 1847289, 453844, 453461	
	B4007-002	\$11.95
	Cap Clip Long Mount, 1 Used Replaces: #1889967, 1889999, 453844, 453461	
	B4008-001	\$14.99
	Distributor Insulator Replaces: #1904376	
	B4008-012	\$6.25
	Delco Advance Spring Replaces: #1912765	

*For 12-Volt Ignition Coils & Accessories, see p.44

John Deere 60, 70 LP with Delco Distributor #1111418		
	B4100-002	\$10.50
	PCR Kit Includes: Points (#B4001-001), Condenser (#B4002-003), Rotor (#B4004-002) Replaces: Points - #D100HP, 1855720 Condenser - #1928111, D203 Rotor - #820445, D400	
	B4004-002	\$5.75
	Rotor Replaces: #820445, D400	
	B4003-017	\$15.25
	Distributor Cap Premium Grade, Made in the USA (Brass Contacts) Replaces: #1908008	

	B4006-001	\$9.99
	Dust Cover Replaces: #1900119	
	B4007-001	\$11.95
	Cap Clip Short Mount, 1 Used Replaces: #1889967, 1847289, 453844, 453461	
	B4007-002	\$11.95
	Cap Clip Long Mount, 1 Used Replaces: #1889967, 1889999, 453844, 453461	
	B4008-001	\$14.99
	Distributor Insulator Replaces: #1904376	

*For 12-Volt Ignition Coils & Accessories, see p.44

John Deere M, MC, MI, MT, 40, 320, 330, 420, 430, 440		
	B4100-001	\$10.50
	PCR Kit Includes: Points (#B4001-001), Condenser (#B4002-001), Rotor (#B4004-002) Replaces: Points - #D100HP, 1855720 Condenser - #1928111, D-203, 1869704, D-200 Rotor - #820445, D400	
	B4004-002	\$5.75
	Rotor Replaces: #820445, D400	
	B4003-017	\$15.25
	Distributor Cap Premium Grade, Made in the USA (Brass Contacts) Replaces: #1908008	
	B4006-001	\$9.99
	Dust Cover Replaces: #1900119	
	B4007-001	\$11.95
	Cap Clip Short Mount, 1 Used Replaces: #1889967, 1847289, 453844, 453461	
	B4007-002	\$11.95
	Cap Clip Long Mount, 1 Used Replaces: #1889967, 1889999, 453844, 453461	
	B4008-007	\$14.99
	Distributor Insulator	
	B4009-001	\$25.99
	Distributor Bushing & Shim Kit	

*For 6-Volt Ignition Coils & Accessories, see p.44

John Deere 266, 400, 401, 410, 440, 450, 480, 3300 Combine		
	B4001-017	\$6.50
Points Replaces: #AT21061, IBP-2040L, IBP-3028BS, 1-33, 1-47V, 1-48		
	B4002-006	\$7.50
Condenser Replaces: #2-31, 2-38, 2-42, 2-95, IAT-1125S, IAT-3076BS, IBB-2042SS-1, IBB-2042-SS3, IG-3927F, IG-3927G, IG-3927K, IG-3927R,		
	B4004-005	\$7.25
Rotor Premium Grade, Made in the USA Replaces: #IBT-1016, IAU-1104, 4-26, 4-2		
	B4003-005	\$18.25
Distributor Cap Premium Grade, Made in the USA (Brass Contacts) Replaces: #AT14962, IBT-1003B, IBT-1003C, 3-133, 3-123		
	B4006-007	\$16.75
Dust Cover Replaces: #31-267, AT14682, IBT-1059B		

*For 12-Volt Ignition Coils & Accessories, see p.44





John Deere 600, 700, 1010, 2010, 2020, 2030, 2510, 2520 with Prestolite Distributor #IBT-4101		
	B4100-010	\$15.75
PCR Kit Includes: Points (#B4001-017), Condenser (#B4002-006), Rotor (#B4004-005) Replaces: Points: #IBP-2040L, IBP-3028BS, 1-33, 1-47V, 1-48 Condenser: #2-31, 2-38, 2-42, 2-95, IAT-1125S, IAT-3076BS, IBB-2042SS-1, IBB-2042-SS3, IG-3927F, IG-3927G, IG-3927K, IG-3927R Rotor: #IBT-1016, IAU-1104, 4-26, 4-2		
	B4004-005	\$7.25
Rotor Premium Grade, Made in the USA Replaces: #IBT-1016, IAU-1104, 4-26, 4-2		
	B4003-005	\$18.25
Distributor Cap Premium Grade, Made in the USA (Brass Contacts) Replaces: #IBT-1003B, IBT-1003C, 3-133, 3-123		
	B4006-007	\$16.75
Dust Cover Replaces: #31-267, AT14682, IBT-1059B		

*For 12-Volt Ignition Coils & Accessories, see p.44

John Deere 600, 700, 1010, 2010, 2030 with WICO Distributor #DBX30091E		
	B4001-003	\$16.75
Points Replaces: #1-5032		

	B4002-007	\$7.00
Condenser Replaces: #2-5094		
	B4003-006	\$25.50
Cap Replaces: #3-5059, AT14190, X30042		
	B4004-006	\$7.25
Rotor Replaces: #4-5017		

*For 12-Volt Ignition Coils & Accessories, see p.44

John Deere 500, 500C		
	B4001-012	\$4.75
Points Replaces: #D108P		
	B4002-001	\$4.75
Condenser Replaces: #1928111, D-203, 1869704, D-200		
	B4004-013	\$4.75
Rotor Premium Grade, Made in the USA Replaces: #D-419R, 1963972		
	B4003-015	\$16.25
Distributor Cap Brass Contacts Replaces: #D-322		
B4006-004	Dust Cover	Replaces: #1960325 \$16.99

*For 12-Volt Ignition Coils & Accessories, see p.44

John Deere 520, 530, 620, 630, 720, 730 Gas with Delco Distributor #1112576		
	B4100-001	\$10.50
PCR Kit Includes: Points (#B4001-001), Condenser (#B4002-001), Rotor (#B4004-002) Replaces: Points - #D100HP, 1855720 Condenser - #1928111, D-203, 1869704, D-200 Rotor - #820445, D400		
	B4004-002	\$5.75
Rotor Replaces: #820445, D400		
	B4003-018	\$15.25
Distributor Cap Premium Grade, Made in the USA (Brass Contacts) Replaces: #1935038		
	B4006-001	\$9.99
Dust Cover Replaces: #1900119		

	B4007-001 Cap Clip Short Mount, 1 Used Replaces: #1889967, 1847289, 453844, 453461	\$11.95
	B4007-002 Cap Clip Long Mount, 1 Used Replaces: #1889967, 1889999, 453844, 453461	\$11.95
	B4008-001 Distributor Insulator Replaces: #1904376	\$14.99
	B4009-001 Distributor Bushing & Shim Kit	\$25.99

*For 12-Volt Ignition Coils & Accessories, see p.44

John Deere 520, 530, 620, 630, 720, 730 Gas with WICO Distributor		
	B4001-003 Points Replaces: #1-5032	\$16.75
	B4002-007 Condenser Replaces: #2-5094	\$7.00
	B4003-019 Cap Replaces: #3-5060	\$33.25
	B4004-006 Rotor Replaces: #4-5017	\$7.25



*For 12-Volt Ignition Coils & Accessories, see p.44

John Deere 70, 80, 720, 730, 820, 830, 840 (Diesel Tractors) with Pony Motor Start & WICO B4027 Distributor Note: Unless Indicated Otherwise, Pony Motors *Requires 2 of Each Item Below*		
	B4001-018 Points Replaces: #1-5009, X7046, R12006 X9021	\$27.99
	B4002-013 Condenser Replaces: #2-5080	\$15.59
	B4015-007 Ignition Coil Replaces: #X9295	\$81.25

	B4017-021 Spark Plug Wire Grommet 4 Used, Replaces: #94-5060	\$1.25
	B4017-022 *Call for Availability* Coil Bar 1 Used, Replaces: #94-5191	\$9.25
	B4016-011 Cover Gasket 1 Used, Replaces: #94-5192	\$3.00
	B9013-012 WICO B4027 Nameplate 1 Used	\$7.00
B1028-030	Original Type PVC Wire Set	\$24.75



John Deere (3-Cylinder) 300, 301, 310, 350, 350B, 1020, 1520 with Prestolite IBT-4301 Distributor		
	B4100-010 PCR Kit Includes: Points (#B4001-017), Condenser (#B4002-006), Rotor (#B4004-005) Replaces: Points: #IBP-2040L, IBP-3028BS, 1-33, 1-47V, 1-48 Condenser: #2-31, 2-38, 2-42, 2-95, IAT-1125S, IAT-3076BS, IBB-2042SS-1, IBB-2042-SS3, IG-3927F, IG-3927G, IG-3927K, IG-3927R, Rotor: #IBT-1016, IAU-1104, 4-26, 4-2	\$15.75
	B4004-005 Rotor Premium Grade, Made in the USA Replaces: #IBT-1016, IAU-1104, 4-26, 4-2	\$7.25
	B4003-020 Distributor Cap Replaces: #IBT-1097A	\$26.75
	B4006-007 Dust Cover Replaces: #31-267, AT14682, IBT-1059B	\$16.75

*For 12-Volt Ignition Coils & Accessories, see p.44



John Deere 3010, 3020 Gas with Clip on Distributor Cap		
	B4100-001 PCR Kit Includes: Points (#B4001-001), Condenser (#B4002-001), Rotor (#B4004-002) Replaces: Points - #D100HP, 1855720 Condenser - #1928111, D-203, 1869704, D-200 Rotor - #820445, D400	\$10.50
	B4004-002 Rotor Replaces: #820445, D400	\$5.75
	B4003-001 Distributor Cap Premium Grade, Made in the USA (Brass Contacts) Replaces: #811735, D300	\$13.50

	B4006-001	\$9.99
Dust Cover Replaces: #1900119		
	B4007-001	\$11.95
Cap Clip Short Mount, 1 Used Replaces: #1889967, 1847289, 453844, 453461		
	B4007-002	\$11.95
Cap Clip Long Mount, 1 Used Replaces: #1889967, 1889999, 453844, 453461		
	B4008-001	\$14.99
Distributor Insulator Replaces: #1904376		
	B4009-001	\$25.99
Distributor Bushing & Shim Kit		

*For 12-Volt Ignition Coils & Accessories, see p.44



John Deere 1010, 2010, 3010, 3020 Gas with Distributor #1112474, 1112623 & others with Screw Down Cap		
	B4100-003	\$9.75
PCR Kit Includes: Points (#B4001-012), Condenser (#B4002-012), Rotor (#B4004-013) Replaces: Points - #D108P Condenser - #D205 Rotor - #D-419R, 1963972		
	B4004-013	\$4.75
Rotor Premium Grade, Made in the USA Replaces: #D-419R, 1963972		
	B4003-015	\$16.25
Distributor Cap Brass Contacts Replaces: #D-322		
B4006-004	Dust Cover	Replaces: #1960325 \$16.99

*For 12-Volt Ignition Coils & Accessories, see p.44

John Deere 4000, 4010, 4020 Gas with Delco Distributor #1112581- Clip-On Cap		
	B4100-001	\$10.50
PCR Kit Includes: Points (#B4001-001), Condenser (#B4002-001), Rotor (#B4004-002) Replaces: Points - #D100HP, 1855720 Condenser - #1928111, D-203, 1869704, D-200 Rotor - #820445, D400		
	B4004-002	\$5.75
Rotor Replaces: #820445, D400		
	B4003-002	\$20.25
Distributor Cap Premium Grade, Made in the USA (Brass Contacts) Replaces: #824735, D301		

	B4006-001	\$9.99
Dust Cover Replaces: #1900119		
	B4007-001	\$11.95
Cap Clip Short Mount, 1 Used Replaces: #1889967, 1847289, 453844, 453461		
	B4007-002	\$11.95
Cap Clip Long Mount, 1 Used Replaces: #1889967, 1889999, 453844, 453461		
	B4008-001	\$14.99
Distributor Insulator Replaces: #1904376		
	B4009-001	\$25.99
Distributor Bushing & Shim Kit		

*For 12-Volt Ignition Coils & Accessories, see p.44

John Deere 4000, 4010, 4020 Gas with Delco distributor #1112466, 1112624 with Screw Down Cap		
	B4100-003	\$9.75
PCR Kit Includes: Points (#B4001-012), Condenser (#B4002-012), Rotor (#B4004-013) Replaces: Points - #D108P Condenser - #D205 Rotor - #D-419R, 1963972		
	B4004-013	\$4.75
Rotor Premium Grade, Made in the USA Replaces: #D-419R, 1963972		
	B4003-021	\$8.75
Distributor Cap Replaces: #1954569, D-316		
B4006-004	Dust Cover	Replaces: #1960325 \$16.99

*For 12-Volt Ignition Coils & Accessories, see p.44

John Deere 4030 Gas with Prestolite Distributor #IBT-6101-N		
	B4001-017	\$6.50
Points Replaces: #AT21061, IBP-2040L, IBP-3028BS, 1-33, 1-47V, 1-48		
	B4002-006	\$7.50
Condenser Replaces: #2-31, 2-38, 2-42, 2-95, IAT-1125S, IAT-3076BS, IBB-2042SS-1, IBB-2042-SS3, IG-3927F, IG-3927G, IG-3927K, IG-3927R,		
	B4004-005	\$7.25
Rotor Premium Grade, Made in the USA Replaces: #IBT-1016, IAU-1104, 4-26, 4-28		
	B4003-066	\$12.75
Distributor Cap Premium Grade, Made in the USA Replaces: #IBT-1030C, D		
	B4006-007	\$16.75
Dust Cover Replaces: #31-267, AT14682, IBT-1059B		

ELECTRONIC IGNITION CONVERSION KITS

Replaces Points & Condenser



John Deere 2 Cyl. A, B, G, 50 with replacement Delco Distributor, 60, 70 GAS

B9600-001	12 Volt Negative Ground	\$154.95
B9600-001P12	12 Volt Positive Ground	\$169.45
B9600-001P6	6 Volt Positive Ground	\$169.45

John Deere 2 Cyl. 520, 530, 620, 630, 720, 730 (Gas & LP) with Delco Distributor

B9600-002	12 Volt Negative Ground	\$154.95
B9600-002P12	12 Volt Positive Ground	\$169.45
B9600-002P6	6 Volt Positive Ground	\$169.45

John Deere 2 Cyl. M, MC, MI, MT, 40, 320, 330, 420, 430, 440 with Delco Distributor

B9600-003	12 Volt Negative Ground	\$154.95
B9600-003P12	12 Volt Positive Ground	\$169.45
B9600-003P6	6 Volt Positive Ground	\$177.45

John Deere 3 Cyl. 300, 301, 310, 350, 350B, 1020, 1520 with Prestolite Distributor #IBT-4301

B9600-056	12 Volt Negative Ground	\$185.95
------------------	-------------------------	-----------------

John Deere 4 Cyl. 1010, 2010, 3010, 3020 with Delco Distributor & Clip On Distributor Cap 2010 with #1112577

B9600-007	12 Volt Negative Ground	\$154.95
B9600-007P12	12 Volt Positive Ground	\$169.45

John Deere 4 Cyl. 1010, 2010, 3010, 3020 Gas with Delco Distributor #1112474, 1112623, & Screw Down Cap

B9600-009A	12 Volt Negative Ground	\$124.95
B9600-009AP12	12 Volt Positive Ground	\$139.95

John Deere 4 Cyl. 400, 401, 410, 450, 480, 600, 700, 1010, 2010, 2020, 2030, 2510, 2520 with Prestolite Distributor #IBT-4101

B9600-060	12 Volt Negative Ground	\$179.95
B9600-060P12	12 Volt Positive Ground	\$198.45

John Deere 4 Cyl. 600, 700, 1010, 2010, 2030 with WICO Distributor

B9600-224	12 Volt Negative Ground	\$169.45
------------------	-------------------------	-----------------

John Deere 4010 (Up to Serial # 39,499) with Delco Distributor #1112581- Has Clip-On Cap

B9600-255LS	12 Volt Negative Ground	\$162.45
B9600-255LSP12	12 Volt Positive Ground	\$175.45

John Deere 6 Cyl. 4000 All, 4010 (Serial #39,500 & Up), 4020 All with Delco Distributor #1112466, 1112624 & Screw Down Cap

B9600-014A	12 Volt Negative Ground	\$124.95
B9600-014AP12	12 Volt Positive Ground	\$139.95



***For Ignition Coils & Accessories, see p.44**

COMPLETE DISTRIBUTORS

New Distributors (Not Rebuilt)

B4027	WICO B4027 Distributor	\$387.50
--------------	-------------------------------	-----------------



Brand New WICO Distributor #B4027, Ignition box
John Deere - 70, 80, 720, 730, 820, 830, 840 (Diesel with Pony Motor Start)

1111558N	Delco 1111558 Distributor	\$319.50
-----------------	----------------------------------	-----------------



Brand New Delco Distributor #1111558
John Deere - A, B, G, 50, 60, 70 Gas Tractors

1112577N	Delco Distributor	\$299.99
-----------------	--------------------------	-----------------

1112581N	Delco Distributor	\$299.99
-----------------	--------------------------	-----------------

Petronix Distributor for WICO #DBX30091E, Delco #1112623

B9500-018	12-Volt, Negative Ground	\$569.25
------------------	---------------------------------	-----------------

B9500-021	12-Volt, Positive Ground	\$698.75
------------------	---------------------------------	-----------------



Replaces: **John Deere** - #AR11145, AR11162R, AT361T, AT14119, AT14384, AT17366, AT21941 **OEM** - #1112623, 1112474, 1112648, IBT-4104U
WICO - #DBX30091E

Fits: **John Deere** - 266, 400, 401, 410, 440,

450, 480, 600, 700, 1010, 2010, 2030, 3010, 3020

Note: Must use Suppression Spark Plug Wire.

Rebuilt Distributors

Our rebuilt distributors are completely torn down, cleaned, inspected & will have the following new parts: points condenser, cap, rotor, bearings, advance springs, tag, plus any additional parts that are needed to make the unit look & perform like new.

1111558R	Exchange:	225.00	Outright:	\$425.00
-----------------	-----------	---------------	-----------	-----------------



Rebuilt Delco Distributor #1111558

John Deere - A, B, G, 50, 60, 70 Gas Tractors

Core Charge: \$200

1112623R	Exchange:	\$295.00	Outright:	\$445.00
-----------------	-----------	-----------------	-----------	-----------------



Rebuilt Delco Distributor #1112623

John Deere - 1010, 2010, 3010, 3020 Gas Tractors



Core Charge: \$150

DISTRIBUTOR ACCESSORIES

B4008-008	Distributor Coil Bracket	\$24.99
	John Deere Replaces - #AA4883R Fits (all with Delco Distributor) - A, B, G, 50, 60, 70, 520, 530, 620, 630, 720, 730	
B4008-009	Distributor Hold Down Clamp	\$7.99
	Note: 2 Used , Each Sold Separately John Deere Replaces - #A4157R Fits (all with Delco Distributor) - A, B, G, 50, 60, 70, 520, 530, 620, 630, 720, 730, 3010, 3020, 4010, 4020	
B4008-018	Distributor Hold-Down Clamp	\$7.99
	Note: 2 Used ; Each Sold Separately John Deere Replaces: #M415T Fits (serviceable for): M, MI, MT, MC, 40, 320, 330, 420, 430, 440, 1010, 2010	

TUNE UP PARTS (WITH MAGNETO)

John Deere A, AH, AR, AW, AI, AO, B, BO, BR, D, DG, G, H, HN with American Bosch Magneto #MJH Series		
	B4011-007	\$25.75
	Points Replaces: #BK52203	
	B4012-003	\$18.50
	Condenser Replaces: #CW5279	
	B4013-033	\$64.50
	Cap Replaces #DP52607, DP52610	
	B4014-013	\$15.75
	Rotor Replaces: #RT52288	
	B4015-015	\$69.25
	Coil Replaces: #SM137	
	B4016-013	\$4.00
	Cap Gasket Replaces: #GA5261	

John Deere A, AH, AR, AW, AI, AO, B, BO, BR, D, DG, G, H, HN with American Bosch Magneto #MRD-2A		
	B4011-007	\$25.75
	Points Replaces: #BK52203	
	B4012-003	\$18.50
	Condenser Replaces: #CW5279	
	B4015-015	\$69.25
	Coil Replaces: #SM137	
	B4013-033	\$64.50
	Cap Replaces #DP52607, DP52610	
	B4014-013	\$15.75
	Rotor Replaces: #RT52288	
	B4016-013	\$5.75
	Cap Gasket Replaces: #GA5261	

John Deere with Fairbanks-Morse Magneto #FMJ-2A6, FMJ-2A6A, FMJ-2B6, FMJ-2B6D, FMJ-2B6E, FMJ-2B6F		
	B4011-010	\$40.75
	Points Replaces: #S2437	
	B4012-001	\$11.00
	Condenser Replaces: #AXMR2433	
	B4013-008	\$131.75
	Call for Availability Cap (Wiper) Replaces: #X2430 (workaround: use B4013-009, B4014-004, & B4017-024)	
	B4017-023	\$16.50
	Wipe Cap Brush 2 Used Replaces: #D2460A	

	B4013-009 Cap (Jump Gap) Replaces: #LX2430	\$89.50
	B4017-024 Wipe Cap Brush 1 Used with B4013-009 above 3/16" diameter, 3/8" length Replaces: #E2460B	\$3.00
	B4014-004 Rotor (Jump Gap)	\$44.25
	B4015-002 Coil Replaces: #R2477C	\$39.75
	B4017-001 Coil Lead Replaces: #FMJL	\$2.75
B4017-058	FMJ Distributor Shaft Clip	\$2.25
B4017-059	FMJ Distributor Shaft Washer	\$2.25
B4017-060	FMJ Distributor Shaft Felt Seal	\$1.75

	B4014-004 Rotor (Jump Gap) Replaces: #Q2765	\$44.25
	B4015-002 Coil Replaces: #R2477C	\$39.75
	B4017-001 Coil Lead Replaces: #FMJL	\$2.75
	B4016-002 Cap Gasket (Inner) Replaces: #H2498	\$2.75
	B4016-005 Flange Gasket Replaces: #SAE	\$1.75
	B4017-002 Rear Ball Bearing Replaces: #C5949	\$11.75
B4017-053	FMX Breaker Plate	\$65.50

John Deere with Fairbanks-Morse Magneto #FMX-2B6, FMX-2B6D, FMX-2B6E, FMX-2B6F		
	B4011-011 Points Replaces: #B2437A	\$12.75
	B4012-001 Condenser Replaces: #AXMR2433	\$11.00
	B4013-008 *Call for Availability* Cap (Wiper) Replaces: #X2430 (workaround to a Jump Gap Cap: use B4013-009, B4014-004, & B4017-024)	\$131.75
	B4017-023 Wipe Cap Brush 2 Used Replaces: #D2460A	\$16.50
	B4013-009 Cap (Jump Gap) Replaces: #LX2430	\$89.50
	B4017-024 Wipe Cap Brush 1 Used with B4013-009 above 3/16" diameter, 3/8" length Replaces: #E2460B	\$3.00

John Deere A, B, D, G, H, R with WICO Series C Magneto #C477B, C1042, C1263, C1300		
	B4110-002 Wico C PCR Tune Up Kit Includes: Points (#B4011-012), Condenser (#B4012-006), Rotor (#B4014-005) Replaces: Points - #1-5084, FWM1256S Condenser - #2-5076, X5999, FXH2724S Rotor - #4-5000, FXH2408	\$45.25
	B4013-010 (no Logo) B4013-041 (with Logo) Outer Cap Replaces: #3-5007, FXC2102, X2938	\$23.75 \$29.75
	B4016-008 Outer Cap Gasket Replaces: #94-5085	\$1.50
	B4013-011 Inner Cap Replaces: #94-5096, FXC2302A	\$49.75
	B4014-005 Rotor Replaces: #4-5000, FXH2408	\$7.75

	B4015-008	\$62.75
	Coil Replaces: #X-2766, 5-5086 \$62.75	
	B4016-009	\$3.75
	Complete Gasket Set Replaces: #90-5030	
	B4017-025	\$6.75
	Bearing 2 Used Replaces: #24-5005	
	B4017-057	\$12.75
	WICO C Coil Bar	
	B4016-005	\$1.75
	Flange Gasket Replaces: #SAE	
	B4017-007	\$12.50
	Impulse Spring Replaces: #94-5016	
	B9013-010	\$7.00
	WICO Series C Nameplate	
B4017-066	Wico C / X Impulse Paw	\$5.50
B4017-067	Impulse Paw Retaining Clip	\$2.75

	B4016-004	\$2.25
	Cap Gasket Replaces: #94-5076	
	B4015-003	\$39.75
	Coil (Hot Coil) Replaces: #5-5011, AR12006, FXH2403, X5700, X5700B, X5700C	
	B4017-003	\$2.25
	Coil Clamp 2 used, each sold separately Replaces: #94-5080	
	B4017-004	\$8.50
	Coil Bar Replaces: #94-5066	
	B4017-005	\$3.50
	Inner Bearing Replaces: #24-5000	
	B4017-006	\$9.75
	Outer Bearing Replaces: #25-5000	
	B4017-046	\$2.75
	Bearing Cage Snap Ring Replaces: #43-5055	
	B4017-007	\$12.50
	Impulse Spring Replaces: #94-5016	
	B4017-044	\$40.00
	Drive Cup with Spring Assembly For C477B & XH477B Magnetos Replaces: #94-5354 (#FXG-3101F)	
	B4017-045	\$42.00
	Drive Cup with Spring Assembly For C1042 & XH1042 Magnetos Replaces: #94-5381	
	B4017-032	\$23.75
	WICO Counter-Clockwise Impulse Trip Arm Assembly Replaces: #94-5115	
	B4017-034	\$14.75
	CCW Paw Mount *Call for Availability* (Included with B4017-032 above) Replaces: #FXH-1025B, 90-5064	
	B4017-008	\$6.25
	Stop Button Assembly Includes #B4017-009 Stop Button Replaces: #90-5042 For the version with a Ground Wire, use #B4017-063 (\$7.26) instead.	
	B4017-009	\$2.25
	Stop Button Replaces: #94-5079	

John Deere A, B, D, G, H, R
with WICO Series X Magneto #XH477B, XH1042,
XH1263, XH1300, XH1886 (Pony Motor)

	B4110-003	\$45.25
	PCR Kit Includes: Points (#B4011-004), Condenser (#B4012-002), Rotor (#B4004-014) Replaces: Points - Replaces: #1-5008, 1-5111, FXH-2100B, FXH-2400B, X5996, AR12014 Condenser - #2-5007, X5614, X6916, AR12013 Rotor (2 Ear) - #4-5003, X5617, AR31318	
	B4017-040	\$2.75
	Condenser Clamp Replaces: #94-5167	
	B4013-007	\$20.25
	Cap Used with 2-Ear Rotor *Includes Gasket Replaces: #3-5000, X5643, FXH2101-2	
	B4004-014	\$13.00
	Rotor 2-Ear Rotor (Used with B4013-007 Cap) Replaces: #4-5003, X5617, AR31318	

	B4017-051 WICO Impulse Catch Plate Replaces: #94-5070, FXH-210S-1	\$10.25
	B4016-005 Flange Gasket Replaces: #SAE	\$1.75
	B4016-012 Striker Plate Gasket Replaces: #94-5154	\$2.25
	B9013-011 WICO Series X Nameplate Fits the WICO Series X magneto (Rivets included)	\$7.00
B4017-042	XH Magneto Rear Bearing	\$28.75
B4017-066	Wico C / X Impulse Paw	\$5.50
B4017-067	Impulse Paw Retaining Clip	\$2.75

	B4016-005 Flange Gasket Replaces: #SAE	\$1.75
	B4017-057 WICO C Coil Bar	\$12.75
	B4017-007 Impulse Spring Replaces: #94-5016	\$12.50
	B9013-010 WICO Series C Nameplate	\$7.00

John Deere L, LA, LUC, LUS with WICO Series C Magneto #C909		
	B4110-002 Wico C PCR Tune Up Kit Includes: Points (#B4011-012), Condenser (#B4012-006), Rotor (#B4014-005) Replaces: Points - #1-5084, FWM1256S Condenser - #2-5076, X5999, FXH2724S Rotor - #4-5000, FXH2408	\$45.25
	B4014-005 Rotor Replaces: #4-5000, FXH2408	\$7.75
	B4013-011 Cap (Inner) Replaces: #94-5096, FXC2302A	\$49.75
	B4015-008 Coil Replaces: #X-2766, 5-5086	\$62.75
	B4016-008 Cap Gasket Replaces: #94-5085	\$1.50
	B4016-009 Complete Gasket Set Replaces: #90-5030	\$3.75
	B4017-025 Bearing 2 Used Replaces: #24-5005	\$6.75

John Deere with WICO Series X Magneto #XH909		
	B4011-004 Points Replaces: # Replaces: #1-5008, 1-5111, FXH-2100B, FXH-2400B, X5996, AR12014	\$17.75
	B4012-002 Condenser Replaces: #2-5007, X5614, X6916, AR12013	\$13.75
	B4017-040 Condenser Clamp Replaces: #94-5167	\$2.75
	B4013-012 Cap Replaces: #3-5012	\$34.25
	B4014-006 Rotor Replaces: #4-5018, FXH1008, X5531	\$8.25
	B4016-004 Cap Gasket Replaces: #94-5076	\$2.25
	B4015-003 Coil (Hot Coil) Replaces: #5-5011, AR12006, FXH2403, X5700, X5700B, X5700C	\$39.75
	B4017-003 Coil Clamp 2 used, each sold separately, Replaces: #94-5080	\$2.25
	B4017-004 Coil Bar Replaces: #94-5066	\$8.50
	B4017-005 Inner Bearing Replaces: #24-5000	\$3.50

	B4017-006 Outer Bearing Replaces: #25-5000	\$9.75
	B4017-046 Bearing Cage Snap Ring Replaces: #43-5055	\$2.75
	B4017-007 Impulse Spring Replaces: #94-5016	\$12.50
	B4017-008 Stop Button Assembly Includes #B4017-009 Replaces: #90-5042 For the version with a Ground Wire, use #B4017-063 (\$7.26) instead.	\$6.25
	B4017-009 Stop Button Replaces: #94-5079	\$2.25
	B4017-051 WICO Impulse Catch Plate Replaces: #94-5070, FXH-210S-1	\$10.25
	B4016-005 Flange Gasket Replaces: #SAE	\$1.75
	B4016-012 Striker Plate Gasket Replaces: #94-5154	\$2.25
	B9013-011 WICO Series X Nameplate Fits the WICO Series X magneto (Rivets included)	\$7.00
B4017-042	XH Magneto Rear Bearing	\$28.75

C477BR 	Exchange	\$445.00
	Outright	\$550.00
Rebuilt WICO C477B Magneto Long Lug Fits: John Deere A (up to Serial #487,999), AR & AO (up to Serial #259,999), B (up to Serial #89,999), BI, BO, & BR (up to Serial #331,499), D (Serial #130,700 & up), G (up to Serial #12,999) Core Charge \$105.00, See Notes		
C1042R 	Exchange	\$445.00
	Outright	\$550.00
Rebuilt WICO C1042 Magneto Short Lug Fits: John Deere - A (Serial #488,000 & up), AR & AO (Serial #260,000 and up), B (Serial #90,000 & up), BI, BO, & BR (Serial #331,500 and up), G (Serial #13,000 & up), H Core Charge \$105.00, See Notes		
C1263R 	Exchange	\$445.00
	Outright	\$645.00
Rebuilt WICO C1263 Magneto Fits: John Deere D (up to Serial #130,699), GP (up to Serial #230,745) Core Charge \$200.00, See Notes		
EDISON-CDR 	Exchange	\$595.00
	Outright	\$770.00
Rebuilt Edison Splitdorf CD Magneto Fits: John Deere D (Serial #35,309 - 187,101) Core Charge \$175.00, See Notes		
XH477BR	Exchange	\$445.00
	Outright	\$770.00
Rebuilt WICO Magneto 2 Cyl. Flange Mount, Long Lug Fits: John Deere - A (up to Serial #487,999), AR & AO (up to Serial #259,999), B (up to Serial #89,999), BI, BO, & BR (up to Serial #331,499), D (Serial #130,700 & up), G (up to Serial #12,999) Core Charge \$325.00, See Notes		
XH477BPULLR 	Exchange	\$445.00
	Outright	\$645.00
Limited Stock Rebuilt WICO Magneto Flange Mounted, Long Lug Converted from 4 Cyl. to 2 Cyl. for Pulling Fits: John Deere - same as XH477BR Core Charge \$200.00, See Notes		

REPLACEMENT MAGNETOS

Rebuilt Magnetos

Our Rebuilt Magnetos are completely torn down, cleaned, & inspected. They will (at the minimum) have the following new parts: Points, Condenser, Coil, Coil Insulators, Lead-out Tower, & Outside Covers, plus any additional parts that are needed to make the unit look & perform like new.

They come with a 1-Year Limited Warranty.

Notes:

1. Unless otherwise specified, cost is exchange price.
2. A core charge (see below) will be charged to your credit card until we receive your good core.
3. A good core is considered a complete magneto with no cracks or weld repairs. Only good cores will be credited.

Magnetos must be used with copper ignition wire. Use of any other type will Void the Warranty.

XH909R	Exchange	\$445.00
	Outright	\$720.00
 <p>Rebuilt WICO Magneto 2 Cyl. Flange Mount Fits: John Deere – L, LA, LI, LUC Core Charge \$275.00, See Notes</p>		

XH1042R (Note: XH1042N is \$485)	Exchange	\$445.00
	Outright	\$770.00
 <p>Rebuilt WICO Magneto 2 Cyl. Flange Mount, Short Lug Fits: John Deere - A (Serial #488,000 & up), AR & AO (Serial #260,000 and up), B (Serial #90,000 & up), BI, BO, & BR (Serial #331,500 and up), G (Serial #13,000 & up), H Core Charge \$325.00, See Notes</p>		

XH1042PULLR	Exchange	\$445.00
	Outright	\$645.00
 <p>*Limited Stock* Rebuilt WICO Magneto Converted from 4 Cyl. to 2 Cyl. for Pulling Flange Mount, Short Lug Fits: John Deere – same as XH1042R above Core Charge \$200.00, See Notes</p>		

XH1263R	Exchange	\$445.00
	Outright	\$770.00
 <p>Rebuilt WICO Magneto Base Mount Magneto Fits: John Deere D (Up to Serial #130,699), GP (Up to Serial #230,745) Core Charge \$325.00, See Notes</p>		

MAGNETO-TO-DISTRIBUTOR CONVERSION KITS

John Deere Magneto to Distributor Conversion Kit (Points Ignition)		
B9040-002	12-Volt	\$419.75
B9040-005	6-Volt	\$419.75
 <p>Converts Short Lug John Deere Magnetos to Points Ignition Distributors. Kit includes: -New Delco Distributor #1111558 - x2 Distributor Clamps - Key Switch, - Coil, - Coil Bracket Fits: A (SN 584,000 and up), B (SN 201,000 and up), G (SN 13,000 and up), H (All). Also 50, 60, 70 (without key switch).</p>		

B9040-003	John Deere Magneto to Distributor Conversion Kit (Electronic Ignition)	\$559.00
As #B9040-002 above, but converts Short Lug John Deere Magnetos to Electronic Ignition Distributors (Negative Ground).		

GAUGES

Ammeters, Universal

B9025-002	Ammeter 20-0-20	\$19.99
		Does not have a logo Fits in 2" Diameter Hole 1.850" From Post to Bottom of Bezel

B9025-005	Ammeter 30-0-30	\$19.99
		Fits in a 2" Diameter Hole 1.740" From Top of Post to Bottom of Bezel

B9025-008	Ammeter 60-0-60	\$19.99
		Uses threaded terminals and is dash mounted Used with 12-Volt Alternator Systems Dimensions:Fits in 2" Diameter Hole Measures 1.765" from Top of Post to Bottom of Bezel

Ammeters, John Deere

B9025-031	John Deere 20-0-20 Ammeter (White Face)	\$25.99
		John Deere Replaces: #AB1190R, AB2568R, AM3554T Fits (Gas & Diesel): A, (Up to SN 700,200), B (Up to SN 306,600), D (Up to Mid-Year 1952, G (Up to SN 60,700) H, L, LA, LI, M, MC, MI, MT, R

B9025-032	John Deere 20-0-20 Ammeter (Black Face)	\$27.99
		John Deere Replaces: JD #AM1864T, AF2749R Fits (Gas & Diesel): A (SN: 700,200 & up), B (SN: 306,600 & up), D (Mid-Year 1952 & Later), G, GN, GW (SN: 60,700 & up), M, MC, MI, MT, R (Mid-Year 1952 & Later), 40, 50, 60, 70, 80, 320, 330, 420, 430, 435, 440, 520, 530, 620, 630, 720, 730, 820, 830, 840 (2-Cylinder)

Oil Pressure Gauges, Universal

B9025-004	Universal Oil Pressure Gauge (0-50 PSI)	\$21.99
	<p>1/8" NPT male threads, studs, & a bracket. No logo included. Requires a 2" diameter hole.</p> <p>John Deere Fits: A, AI, AN, ANH, AO, AOS, AR, AW, AWH, B, BI, BN, BNH, BO, BR, BW, BW40, BWH40, D, DI, G, GH, GM, GN, GW, H, HN, HNH, HW, HWH, 50, 60, [70, 720, 730 (Gas/LP)], 520, 530, 620, 630</p>	
B9025-001	Universal Oil Pressure Gauge (0-80 PSI)	\$24.99
	<p>1/8" NPT male threads, studs, & a bracket. No logo included. Requires a 2" diameter hole.</p> <p>John Deere Fits: 820 (2-cylinder), 830 (2-cylinder), R, 70, 80, 720, 730, 840</p>	

Oil Pressure Gauges, John Deere

B9025-033	John Deere Oil Pressure Gauge (Dash Mounted)	\$27.99
	<p>Rated at 0-25 PSI.</p> <p>John Deere Replaces: #AB1549R Fits Models: [A, AN, AW (SN: 477000 to 700199)], [AO, AR (SN: 272000 to Mid-1952)], B, BN, BNH, BW, BWH (SN: 60000 to 306599)], D (SN: 143800 to Mid-1952), [G, GH, GM, GN, GW (SN: 13000 to 60699)], H, HN, HNH, HW, HWH</p>	
B9025-034	John Deere Oil Pressure Gauge (Engine Mounted)	\$27.99
	<p>Rated at 0-25 PSI.</p> <p>John Deere Replaces: #AB292R, AM737T, AA1730R Fits Models: [A, AN, AW (Up to SN: 476999)], [AO, AR (Up to SN 271999)], AOS, [B, BN, BNH, BW, BWH (Up to SN: 59999)], BO, BR, D (Up to SN: 143799), [G, GH, GN, GW (Up to SN: 12999)] M, MC, MI, MT</p>	
B9025-035	John Deere Oil Pressure Gauge (Dash Mounted)	\$27.99
	<p>Mechanical gauge, stud is included. Rated at 0-25 PSI. 1/8" NPT.</p> <p>John Deere Replaces: #AF2752R, AF2775R Fits Models: Styled A (SN 700200 & Up), Styled B (SN 306600 & Up), Styled D (Mid 1952 & later), H, Styled G (SN 60700 & Up), GM, 50, 60, 70 Gas, 330*, 430*, 440*, 520, 530, 620, 630, 720 Gas, 730 Gas Requires purchase of B9026-001 copper line kit if installing on JD 330, 430, & 440 Gas</p>	

B9025-036	John Deere Oil Pressure Gauge (Engine Mounted)	\$27.99
	<p>Has a black face. Rated at 0-30 PSI. 1/8" NPT.</p> <p>John Deere Replaces: #AM284T Fits Models: (M, MC, MI, MT Mid 1952 & Up) 40, 320, 420,</p>	
B9025-037	John Deere Oil Pressure Gauge (Dash Mounted)	\$34.99
	<p>Has a black face. Rated at 0-55 PSI.</p> <p>John Deere Replaces: #AF2868R, Sub AF2729R Fits Models: R Mid 1952 & Up 70 Diesel, 80, 720 Diesel, 730 Diesel, 820 (2-Cylinder), 830 (2-Cylinder)</p>	
B9025-081	John Deere Transmission Oil Pressure Gauge	\$45.99
	<p>Has a 2.030" Housing OD and a 1/8" NPT Male Thread. Note: Has No Provision for a Fiber Optic Light.</p> <p>John Deere Replaces: #R34259 Fits (with Power Shift Transmission): 500, 500A (up to SN: 123113), 600, 2510, 3020 (up to SN: 122999), 4020 (up to SN: 200999)</p>	

Oil Pressure Gauge, Line Kit

B9026-001	Oil Pressure Gauge Line Kit	\$29.99
	<p>6 FT copper 1/8" line. Includes: (2) 5/16 - 24 UNF nut, (2) compression sleeves, (1) 1/8 - 27 NPTF female to 5/16" - 24 UNF male adapter --- Note: Depending on application customer may be required to purchase other fittings.</p>	
B9026-004	Oil Pressure Gauge 1/4" to 1/8" NPT Adapter Fitting	\$15.99
	<p>Adapter Fitting for Oil Gauges - 1/4" to 1/8" NPT.</p> <p>John Deere Replaces: #AR1312R Fits (1/4" tubing only): A, AN, ANH, AO, AOS, AR, AW, AWH, B, BN, BNH, BO, BR, BW, BWH, D, G, GH, GM, GN, GW, H, HN, HNH, HWH, R, 50, 520, 530, 60, 620, 630, 70, 720, 730, 80, 820 2 Cylinder, 830 2 Cylinder</p>	

Transmission Oil Temperature Gauges

B9025-082	John Deere Transmission Oil Temperature Gauge	\$45.99
	<p>2.036" Housing OD, a 51" long Capillary Lead, a 5/8" - 18 UF Probe End, and a 1/2" NPT Pipe Bushing.</p> <p>Note: Has No Provision for a Fiber Optic Light.</p> <p>John Deere Replaces: #R34258 Fits (with Power Shift Transmission): 500, 500A (up to SN: 123113), 600, 2510, 3020 (up to SN: 122999), 4020 (up to SN: 200999)</p>	

B9025-067	John Deere Transmission Oil Temperature Gauge	\$45.99
	<p>65" Capillary Lead, Chrome Bezel, and Metal Housing. Fits in 2" Diameter Hole with a 5/8"-18 UF probe & 1/2" NPT Pipe Bushing. Gauge also Provides Means for Fiber Optic Light.</p> <p>John Deere Replaces: #AR46979 Fits (with Synchro or Power Shift Transmission): 3020 (SN: 123000 & Up), 4000, 4320, 4520, 4620, 4020 (SN: 201000 & Up)</p>	

B9025-066	John Deere Water Temperature Gauge	\$34.99
	<p>72" capillary lead. Has 5/8"-18 UNF end with 1/2" NPT pipe bushing.</p> <p>John Deere Replaces: #AA6295R, AA7263R, AM2444T, AR20783R, AR490R, AT13849T Fits: Models: [A, AH, AN, AW (SN: 700200 & up)], [AR, D (Styled Mid 1952 & later)], [B, BN, BW (SN: 306600 & up)], [G, GH, GN, GW (SN: 60700 & up)], [M, MC, MI, MT, R (Mid 1952 & later)], 320, 330, 40, 420, 430, 440, 50, 520, 530, 60, 620, 630, 70, 720, 730, 80, 820 (2-cylinder), 830 (2-cylinder), 840 (2-cylinder)</p>	

Water Temperature Gauges

B9025-007	Universal Water Temperature Gauge	\$34.99
	<p>Dash-mounted (parts included), 72" long heavy duty capillary tube</p> <p>John Deere Fits (Using 72" Or Shorter Capillary Lead): A, AH, AI, AN, ANH, AO, AOS, AR, AW, AWH, B, BN, BNH, BO, BR, BW, BWH, BWH40, D, G, GH, GM, GN, GW, H, HN, HNH, HW, HWH, M, MC, MI, MT, R, 40, 50, 60, 70, 80, 320, 330, 420, 430, 520, 530, 620, 630, 720, 730, 820 (2-Cylinder), 830 (2-Cylinder), 840</p>	

B9025-040	John Deere Water Temperature Gauge	\$34.99
	<p>36" Right Angle Lead.</p> <p>John Deere Fits Models: [A, AH, AN, AW (Styled models SN:700,200 & Up)], [B, BN, BW (Styled models SN: 306,600 & Up)], [G, GH, GN, GW (Styled Models, SN: 607,000 & Up)]</p>	

B9025-038	John Deere Water Temperature Gauge	\$39.99
	<p>23" Lead.</p> <p>John Deere Replaces: #AA883R, AA3538R Fits Models: A (Up to SN 476999), [AO, AR (Up to SN 264299)], B (Up to SN 166999), BO, BR, D (SN 125430 to 143799), G (Up to SN 12999), H</p>	

B9025-041	John Deere Water Temperature Gauge	\$34.99
	<p>48" Right Angle Lead.</p> <p>John Deere Replaces: #AA6295R, AA7263R, AF2192R, AF2774R, AM2444T, AM3092T, AM3950T, AR20783, AT13849T Fits Models: [A, AH, AN, AW (Styled Mid 1952 & Up, SN: 700200 & Up)], [AO, AR (Styled Mid 1952 & Up)], [B, BN, BW (Will fit models with SN: 306600 & Up but the lead will be longer than needed)], D (Styled Mid 1952 & Later), [G, GH, GN, GW (Styled (SN: 60700 & Up))], [M, MC, MI, MT, MTN, MTW (Mid 1952 & Up)], [320, 330, 420, 430, 440 (Gas, LP)], 40 (1952 & Later; Gas, LP), [50, 520, 530, 60, 620, 630, 70, 70D, 720D, 730, 730D</p>	

B9025-039	John Deere Water Temperature Gauge	\$34.99
	<p>4' Lead.</p> <p>John Deere Replaces: #AA1342R, AM2444T, AA3535R, AA3534R Fits Styled Models: [A, AH, AN, ANH, AW, AWH (SN: 477000 to 700200)], [AO, AR (SN: 272000 & Up)], [B, BN, BNH, BW, BWH, BWH40 (SN: 60000 to 306600)], D (SN: 143800 to Mid-Year 1952), [G, GH, GM, GN, GW (SN: 13000 to 60700)], [M, MC, MI, MT, MTN, MTW (To Mid 1952)], R (To Mid 952)</p>	

B9025-042	John Deere Water Temperature Gauge	\$41.99
	<p>29" Lead. Max temperature is 250°F. Minimum is 100°F.</p> <p>John Deere Replaces: #AR36383, R34263 Fits (Gas & Diesel, through 1968): 2510, 5010, 3020 (up to SN: 122999), 4020 (up to SN: 200999), 5020 (up to SN: 024999)</p>	

B9025-056	John Deere Water Temperature Gauge	\$34.99
	<p>6' Lead with a Probe Length of 2.34". Fits 2" Diameter Hole & is 2" from Top of Post to Bezel Bottom.</p> <p>John Deere Replaces: #AA1342R, AM1609T, AM610T Fits (Some, To Mid 1952): A, AH, AI, AN, ANH, AO, AOS, AR, AW, AWH, B, BI, BN, BNH, BO, BR, BW, BW40, BWH, BWH40, D, DI, G, GH, GM, GN, GW, H, HN, HNH, HW, HWH, M, MC, MI, MT, R</p>	

B9025-062	John Deere Water Temperature Gauge	\$45.99
	<p>29" Capillary Lead with 5/8-18" UNF End & 1/2" NPT Pipe Bushing. Housing is 2.036". Does not include a mounting bracket with studs. Has no provision for fiber optic lighting.</p> <p>John Deere Replaces: #AR26720, AR31901 Fits: 3010, 4010 (Gas/Diesel)</p>	

B9025-050	John Deere Water Temperature Gauge	\$45.99
	<p>26" Capillary Lead with 5/8-18" UNF End & 1/2" NPT Pipe Bushing. Housing is 2.045" & doesn't include mounting bracket with studs. Has provision for fiber optic lighting. Temp Range 100°F to 247°F.</p> <p>John Deere Replaces: #AR45345, AR48640 Fits: 500A, 500B, 510, 2520, 3020 (Serial #123,000 & Up), 4000, 4020 (Serial #201,000 & Up), 4320, 4520, 4620, 7020</p>	

B9025-060	John Deere Fuel Gauge, 12 Volt Positive Ground	\$45.99
	<p>Fits in 2" Diameter Hole. 1.850" from Top of Post to Bottom of Bezel.</p> <p>John Deere Replaces: #AR26716 Fits (Gas & Diesel): 3010, 4010, 8020, 5010 (Up to SN: 7999)</p>	

B9025-064	John Deere Fuel Gauge, 12 Volt Positive Ground ONLY	\$45.99
	<p>Fits in a 2" Diameter Hole. Depth is 1.205" with a Resistance of 0-30 Ohms.</p> <p>John Deere Replaces: #AR46271, AT27153, R34262, RE54427 Fits: 2510, 8020 (Gas & Diesel), 3020 (Gas & Diesel, up to SN: 122999), 4020 (Gas & Diesel, up to SN: 200999), 5010 (SN: 8000 & up), 5020 (Gas & Diesel, up to SN: 24999) Industrial: 500, 500A (up to SN: 123113), 600 Skidder: 440, 440A, 440B (all to SN: 49999) Crawlers: 1010, 2010 (both SN: 42001 & up; Gas & Diesel)</p>	

B9025-061	John Deere Fuel Gauge, 12 Volt Negative Ground ONLY	\$41.99
	<p>Dash Mounted and rated at 30-250 Ohms. 1.465" Housing Depth.</p> <p>Note: gauge is taller/deeper than original.</p> <p>John Deere Replaces: #AR45436, AT375294 Fits: 2520, 3020 (Serial #123000 & Up), 4000, 4020 (Serial #201000 & Up), 4320, 4520, 4620, 500A (Serial #123114 To 152141), 500B, 5020 (Serial #25000 & Up), 6030, 7020, 7520</p>	

Fuel Gauges, John Deere

B9025-057	John Deere Fuel Gauge, 12 Volt Negative Ground	\$42.99
	<p>Fits 2" Diameter Hole. 1.930" from Top of Post to Bezel Bottom. 0 - 30 Ohms Resist.</p> <p>John Deere Replaces: #AR46271, AT27153, R34262, RE54427 Fits (Gas & Diesel): 500 Industrial, 1010 (Tractors & Crawlers, SN: 42001 & Up), 2010 (Tractors & Crawlers, SN: 42001 & Up), 2510, 3020 (up to SN: 122999), 4020 (up to SN: 200999), 5010 (SN: 8000 & up), 5020 (up to SN: 24999)</p>	

B9025-058	John Deere Fuel Gauge, 6 Volt Positive Ground	\$42.50
	<p>Fits 2" Diameter Hole. 2.250" from Top of Post to Bottom of Bezel. 0-30 Ohm Range.</p> <p>John Deere Replaces: #AF2170R, AF2739R Fits (Dsl. With Pony Engine & 6 Volt System): 70, 720, 730, 80, 820 (2-cylinder), 830 (2-cylinder)</p>	

B9025-059	John Deere Fuel Gauge, 12 Volt Positive Ground	\$42.50
	<p>Fits 2" Diameter Hole. 2.250" from Top of Post to Bottom of Bezel. 0-30 Ohm Range.</p> <p>John Deere Replaces: #AF2721R Fits: 520, 530, 620, 630, 720 & 730 (Gas) (12/24 volt electric start) - 720, 730 (Diesel), 820 & 830 (2-cylinder)</p>	





B9025-077	John Deere Fuel Gauge, 12 Volt Negative Ground	\$42.50
	<p>Fits 2" Diameter Hole. 2.250" from Top of Post to Bottom of Bezel. 0-30 Ohm Range.</p> <p>John Deere Replaces: #AF2721R Fits: 520, 530, 620, 630, 720 & 730 (Gas) (12/24 volt electric start) - 720, 730 (Diesel), 820 & 830 (2-cylinder)</p>	

B9025-093	Fuel Gauge Sending Unit Kit	\$79.99
	<p>0 - 200 Ohm Range, Negative Ground</p> <p>John Deere Replaces Fuel Gauge - #AL18155 AL24294, Sending Unit - #AL18156 AT20912, Gasket - #L29265 Fits: 820 (3 Cyl.), 830 (3 Cyl.), 1020, 1030, 1120, 1520, 1530, 1630, 2020, 2030, 2040 (up to SN: 349,999), 2130, 2240 (up to SN: 349,999), 2440 (up to SN: 349,999), 2640 (up to SN: 349,999), 2840</p>	

Tachometers, John Deere

B9025-071	John Deere Tachometer	\$179.99
	<p>Housing Fits in 4-1/2" Diameter Hole.</p> <p>John Deere Replaces: #AR50954, AR65445, AT159296, AT20641, T22409 Fits: 1020, 1520, 1530, 2020, 2030, [2040, 2240 (Up to Serial #349999)], 2440 (Up to Serial #340999), 2630, 2640 (Up to Serial #340999), Industrial: 401A</p>	

B9025-078	John Deere 2510, 2520, 3020 (Red Needle, Up to 1968)	\$214.99
	<p>(No provision for back light and fiber optics.)</p> <p>John Deere Replaces: #AR32838, AR39909, AR39910, AR45442, AR48019, AR50400, AR50404, RE206853 Fits (Gas & Diesel with Synchro Range Transmission): 2510, 2520, 3020</p>	

B9025-091	John Deere 2510, 2520, 3020 (White Needle, 1968 and up)	\$214.99
	Has provision for back light and fiber optics. John Deere Replaces: #AR32838, AR39909, AR39910, AR45442, AR48019, AR50400, AR50404, RE206853 Fits (Gas & Diesel with Synchro Range Transmission): 2510, 2520, 3020	
B9025-069	John Deere Tachometer (Red Needle, Up to 1968)	\$195.99
	John Deere Replaces: #AR26718, AR30143, AR32833, AR39906, AR39908, AR45444, AR48021, AR50402, AR50406, RE206855 Fits (Gas & Diesel with Synchro Range Transmission): 3010, 4000, 4010, 4020, 4320, 4520, 4620, 5010, 5020, 6030	
B9025-087	John Deere Tachometer with (Red Needle, Up to 1968)	\$214.99
	(No provision for back light and fiber optics.) John Deere Replaces: #AR32830, AR39904, AR45443, AR48020, AR50401, AR50405, RE206854 Fits (Gas & Diesel with PowerShift Transmission): 2510, 2520, 3020, 4020 (SN: 250,001 and up),	
B9025-084	John Deere Tachometer with (Red Needle, Up to 1968)	\$214.99
	(No provision for back light and fiber optics.) John Deere Replaces: #AR32827, AR39902, AR45445, AR48022, AR50403, AR50407, RE206857 Fits (Gas & Diesel with PowerShift Transmission): 600, 4000, 4020 (up to SN: 250,000), 4520, 4620	
B9025-068	John Deere Tachometer (White Needle, 1968 & Up)	\$214.99
	Has provision for back light and fiber optics. John Deere Replaces: #AR26718, AR30143, AR32833, AR39906, AR39908, AR45444, AR48021, AR50402, AR50406, RE206855 Fits (Gas & Diesel with Synchro Range Transmission): 3010, 4000, 4010, 4020, 4320, 4520, 4620, 5010, 5020, 6030	

B9025-079	John Deere Tachometer (White Needle, 1968 & Up)	\$214.99
	Has provision for back light and fiber optics. John Deere Replaces: #AR32830, AR39904, AR45443, AR48020, AR50401, AR50405, RE206854 Fits (Gas & Diesel with PowerShift transmission): 2510, 2520, 3020, 4020 (SN: 250001 & up)	

B9025-086	John Deere 2-Cylinder Tachometer	\$148.99
	Mounting studs are in the correct locations at 6 and 12 o'clock. John Deere Replaces: #AB5132R, AB5134R, AF1719R, AF2066R, AF2698R, AR20055R, AR20825, AR20836, AR21661, AR21662, AR21663, AR21663R, AR21664R Fits: A (SN 648,000 and up), B (SN 201,000 and up), AO (SN 272,000 and up), AR (SN 272,000 and up). Gas/LP: 50, 60, 70, 530, 620, 630, 720, 730 Diesel: 70, 720, 730. Serviceable: Face plate will have the wrong Mph: 80, 820 2-cyl., 830 2-cyl. 840 2-cyl.	

Tachometer Drive Cables

***Please Check Length Before Ordering**

B9026-002	33 1/4" Tachometer Drive Cable	\$29.99
	Restoration Quality. Drive Cable for Tachometers. Measures 33 1/4" Outer Sheath Length. 5/8"-18 x 7/8"-18 Threads with Key On One End. John Deere Replaces: #AR26721 Fits: 3010, 3020, 4000, 4010, 4020, 4320, 4520, 4620	

B9026-003	56" Tachometer Drive Cable	\$34.99
	Restoration Quality. Drive Cable for Tachometers. Measures 56" Outer Sheath Length. 5/8"-18 x 7/8"-18 Threads with Key On One End. John Deere Replaces: #AM3131T, AR70112 Fits: 420, 430, 440 (gas), 8440, 8630, 8640	

B9026-005	30 1/2" Tachometer Drive Cable	\$15.99
	Restoration Quality. Measures 29 7/8". Outer Sheath Length. 5/8"-18 x 7/8"-18 Threads with Key On One End. John Deere Replaces: #AR60877 Fits: 4030	

B9026-010	John Deere 620, 630 Tachometer Cable	\$39.99
	Tip to tip length of 13.75", and 5/8 - 18 x 7/8 - 18 Threads with Key on one end. John Deere Replaces: #AA6573R, AA6737R, AA6738R, AR20833R, AR21233R, AR21234R Fits: 620, 630	

B9026-013	36" Tachometer/ Speedometer Cable	\$29.99
	36" long, 5/8 - 18 x 7/8 - 18 Threads with Key on One End John Deere Replaces: #AR60876, AR62311 Fits: 500C (Industrial), 4230, 7020	

B9026-015	8 1/4" Tachometer/ Speedometer Cable	\$39.99
	8.25" Total Length, 7.5" Outer (Steel) Sheath Length, 5/8 - 18 x 7/8 - 18 Threads with Key on One End John Deere Replaces: #AB47437R, AB4765R, AB4776R Fits: A (SN: 648000 and up), AO (SN: 272000 and up), AR (SN: 272000 and up), B (SN: 201000 and up), 50, 60, 70 (gas)	

B9026-017	17 1/4" Long Tachometer/ Speedometer Cable	\$39.99
	17.875" tip to tip (inner cable), 17.25" Outer Sheath Length, 5/8 - 18 x 7/8 - 18 Threads with Key on One End John Deere Replaces: #AA6573R, AF2067R, AF2245R, AF2246R, AF3258R, AF3259R, AF3260R, AR20834R, AR20835R, AR20837R, AR20839R, AR21160R, AR21161R Fits: 70 (Diesel), 720 (Gas, Lp, & Diesel), 730 (Gas & Lp)	

FUEL SENDING UNITS

B9037-001	John Deere Fuel Sending Unit	\$56.99
	0-30 Ohms. 11 3/4" Overall Length. 2" Bolt Circle. For Positive and Negative Ground Systems. 2 Cylinder Gas and Diesel. John Deere Replaces: #AB5139R, AF2173R, AR1112R Fits: 520, 530, [620, 630 (GP, Standard, & Orchard)], [70, 720, 730 (Gas, LP, & Diesel)], 80, 820 2 Cyl, 830 2 Cyl, 840	

B9037-004	John Deere Fuel Sending Unit	\$44.99
	0-30 Ohms. 16 3/4" Overall Length. 2" Bolt Circle. For Positive and Negative Ground Systems. Gas and Diesel. John Deere Replaces: #AR26434 Fits (Gas & Diesel): 500 (up to SN: 67,999), 3010, 3020 (up to SN: 122,999), 4010, 4020 (up to SN: 200999), 8020	

B9037-002	John Deere Fuel Sending Unit	\$47.99
	30-250 Ohms. 17" Overall Length. 2" Bolt Circle. For Positive and Negative Ground Systems. Gas and Diesel. John Deere Replaces: #AR46268 Fits (Gas & Diesel): 3020 (SN: 123,000 & Up), 4000, 4020 (SN: 201,000 & Up), 4320	

FIBER OPTIC LEADS

B9029-001	8" Fiber Optic Lead	\$33.99
	New 8" Fiber Optic Lead for John Deere Tachometer Gauges. Has a Rubber Boot for Good Sealing. Made in the USA. John Deere Replaces: #AR48016 Fits: 2520, 3020 (Serial #12300 and up, with side console), 4000, 4020 (Serial #201000 and up, with side console), 4520	

SWITCHES

B5011-002	Light Switch Resistor	\$15.99
	John Deere Replaces: Delco - #1838155, 1882994, 1878070 John Deere - #AB2687R Fits (using original switch and cutout): L, LA, M, MC, MT (using AB2687R Switch): A (SN: 477000 to 5197910, AO (Up to SN: 261847), AR (Up to SN: 261847), BO (Up to SN: 332612), BR (Up to SN: 332612) D (SN: 143800 to 153988)	

Knobs

B5001-001	Black Bakelite Knob with "LIGHTS" Imprinted		
	Qty 1-9	\$4.20	Qty 100-499 \$2.73
	Qty 10-25	\$3.36	Qty. 500-999 \$2.42
	Qty 26-99	\$3.05	Qty. 1000+ \$2.10
#10/32 Threads. Interchangeable knob with all our available Push/Pull Switch Products.			

B5001-002	Plain Black Bakelite Knob	\$5.99
	#10/32 Threads. Interchangeable with all our available Push/Pull Switch Products	

B5001-003	Chrome Plated Solid Brass Knob	\$3.50
	#10/32 Threads. Interchangeable with all our available Push/Pull Switch Products	

B5001-009	Combo Light Switch Knob	\$6.99
	Fits #B9017-010, B9016-018, B9016-032, B9016-033. Also fits combo rear lights when 'handle' style knob is required. John Deere Replaces: #AA5332R Fits: A, AH, AN, ANH, AO, AR, AW, AWH, B, BN, BNH, BW, BWH, BWH40, D, G, GH, GM, GN, GW, R, 520, 530, 620, 630, 70, 720, 730	

B5001-008	4-Position Light Switch Knob	\$14.99
	(Used with switch #B5010-009) John Deere Replaces: #AR54445, R46092 Fits: 4020 (SN 250001 and up), 2520, 3020 (SN 150001 and up), 4000 (SN 250001 and up), 4030, 4230, 4320, 4520 (SN 142450 and up), 4620, 4630, 5020 & 6030 with cab, 2750 (SN 22001 and up)	

B5001-006	4-Position Light Switch Knob	\$14.99
	(Used with switches #B5010-007, B5010-008, & B5010-014) John Deere Replaces: #AR27963, & AT65316 Fits 1010, 2010, 2510, 2520 (Up to Serial #22,000), 3010, 3020 (Up to Serial #150,000), 4000 (Up to Serial #250,000), 4010, 4020 (Up to Serial #250,000), 4520 (Up to Serial #142,449), 5010, 8020, [5020, 6030 (Without Sound Guard Cab)]	

B5003-014	Ignition Key Switch	\$54.99
	Genuine Cole Hersee Ignition Key Switch, OEM, 6 Spade Terminals and a 5/8" 32 Unthreaded Stem. Includes Jam Nut, Star washer, and 2 Keys (aftermarket) John Deere Replaces: #AR39505 Fits: 2510 (Gas & Diesel), 3020 (Diesel, SN: 068000 - 122999), 3020 (Gas, SN: 068000 - 122999), 4020 (Diesel, SN: 091000 - 200999), 4020 (Gas, SN: 091000 - 200999), 5010 (SN: 008000 & Up), 5020 (Up to SN: 024999)	

IGNITION SWITCHES

Push/Pull Switches

B5002-001	2 Position Push/Pull Switch	\$7.75
	OFF/ON Universal 2 Position Push/Pull (2 Screw Terminals) Mounting Stem 3/8"-32 Thread Knob #10/32 Thread	

B5003-016	Ignition Key Switch	\$43.50
	Genuine Cole Hersee Ignition Key Switch, OEM, 6 Spade Terminals and a 5/8" 32 Unthreaded Stem. Includes 2 Keys (aftermarket) John Deere Replaces: #AR26528 Fits (Gas/LP): 1010 (Up to SN: 51,039), 2010 (Up to SN: 55,380), 3010, 4010, 3020 (Up to Serial #67,999), 4020 (Up to Serial #90,999)	

B5002-005	3-Position Push/ Pull Switch	\$29.75
	Low Charge/High Charge/Lights (3 Position Switch) 3 Screw Type Mounting Stem .8" Thread Knob #10/32 Thread Premium Quality Made by the OEM Manufacturer	

B5003-024	Ignition Key Switch w/ 2 Keys & Mounting Nut	\$19.99
	12-volt, 35-amp, 7 spade terminals, fits 1" hole. 4 Positions: Accessory, Off, Run, & Start John Deere Replaces: #AR47239, AR47458, AR47459, AR53452, AR58126 Fits: 830 (3-cylinder), 1020 (SN: 117,500 & up), 1030, 1520 (SN: 117,500 & up), 1530, 2020 (SN: 117,500 & up), 2030 (SN: 117,500 & up), 2040, 2130 (SN: 152,400 & up), 2150, 2240, 2350, 2355, 2440, 2520, 2550, 2555, 2630, 2640, 2750, 2755, 2840, 2940, 2950, 3020 (SN: 123,000 & up), 4000, 4020 (SN: 201,000 & up), 4030, 4040, 4050, 4230, 4240, 4250, 4320, 4430, 4440, 4450, 4455, 4620, 4630, 4640, 5020 (SN: 25,000 & up), 6030, 7020, 7520, 8430, 8630	

Key Switches

B5003-001	2 Position Battery Key Switch	\$14.75
	Universal OFF/ON 2 Position Key Switch (For Battery Ignition) (2 Screw Terminals) Mounting Stem 3/4"-20 Thread	

B5003-012	Ignition Key Switch	\$79.99
	3-Position (OFF/ON/Start) Genuine Cole Hersee Key Switch, OEM, 6 Spade Terminals and a 5/8" 32 Unthreaded Stem. Includes 2 Keys John Deere Replaces: #AR26557 Fits Diesel Models: 3010, 3020 (Up to Serial #67,999), 4010, 4020 (Up to Serial #90,999), 5010 (Up to Serial #7999), 8020	







B5003-025	OEM Ignition Key Switch w/ 2 Keys	\$54.99
	8-Amp, 4-Position, 4 Spade Terminals Genuine Cole Hersee switch, Includes an extra key John Deere Replaces: #AT18721, AT21880 Fits (up to SN 117,499): 1020, 1520, 2020, 2030	

B5003-013	Ignition Key Switch	\$32.99
	2 Screw Terminals and a 7/8" 27 Unthreaded Stem. John Deere Replaces: #AB4063R, AB4087R, AA5592R, A4699R Fits 820 (2 cyl), 830 (2 cyl), A (SN: 662874 & Up), AO & AR (SN: 275533 & Up), B (SN: 268820 & Up), BN, BNH, G (SN: 46501 & Up), GN, GW, 80, 420	

B5003-003	3 Position Battery Key Switch	\$29.75
	*Call for Availability* OFF/IGN/IGN(Start) 3 Position Key Switch, for Battery Ignition, 3 Screw Terminals Mounting Stem 3/4"-20 Thread 10 Amp Replaces: #AT11309, AT11342 Fits: John Deere 435, 440 Diesel	



COMBINATION SWITCHES

Note: Lever not included unless otherwise specified.

B5009-001	Combination Switch	\$39.99
	6/12-Volt, 30 Amp, 5 Screw Type Terminals John Deere Replaces: #AM1866T & #AA5071R Fits: 40, 50 Gas (to SN: 5021479); 60 Gas Row Crop (Up to SN: 6029999), 60 Standard Gas (Up to SN: 6042999), 60 Orchard, 70 Gas, 70 Hi-Crop Gas, 70 Standard Gas, 320, 330, 420, 430, 435, 440, 620 Orchard (SN: 6223000 & Up)	
B5009-002	Combination Switch	\$29.95
	12-Volt, 6 Spade Terminals John Deere Replaces: #AR20430R *Will Not Work On Diesels* Fits: 530, 630, 730 Gas	
B5009-003	Combination Switch with Lever	\$94.99
	5 Position, 30 Amp, 5 Screw Type Terminals, Includes Lever John Deere Replaces: #AM357T & #AM812T Fits (with Cut-Out Relay): M, MC, MI, MT	
B5009-004	Combination Switch	\$51.99
	12-Volt, 30 Amp, 6 Screw Terminals John Deere Replaces: #AA5397R Fits: 50 (SN: 5021480 & Up), 50 LP (SN: 502400 & Up), 60 Gas Row Crop (SN: 6030000 & Up), 60 Standard (SN: 6043000 & Up), 70 LP/Standard LP; 520 ; 620 , 620 Orchard (Up to SN: 6222999), 720 Gas	
B5009-005	Combination Switch	\$153.99
	24-Volt Electric Start for Two Headlights John Deere Replaces: #AR20234 Fits: 70D (When Converted to 24-Volt Electric Start), 720D, 730D, 820 2-Cylinder, 830 2-Cylinder (All Electric Start & 2 Headlights)	
B5009-006	Combination Switch	\$72.99
	24-Volt Electric Start for Four Headlights 30 Amp, 8 Spade Terminals John Deere Replaces: #AR20444 Fits: 720/730 Diesel Electric Start With 4 Lights (Flat Fenders), 840 Diesel Electric Start With 4 Lights	

B5009-009	Combination Switch	\$79.99
	6-Volt John Deere Replaces: #AR2065R & AR2460R Fits: 70, 720 (Diesel Pony), [80, 820 2-cylinder]	
B5009-007	Combination Switch	\$124.99
	6 Volt John Deere Replaces Resister: #AF2143R Switch: #AR20433, & AR21162 Fits: 730 (Diesel Pony Start, 2 and 4 light), [830 2-cylinder, 840 (Pony Start)]	
B5001-007	Combination Switch Lever w/ Hardware	\$6.75
	For Use with #B5009-001, B5009-002, B5009-003, & B5009-004. John Deere Replaces: #A4653R & #1902694 Fits: M, 40, 50, 60, 70, 320, 330, 420, 430, 435, 440, 520, 530, 620, 630, 720, 730, 1020, 1520, 2020, 8430, 8630	

LIGHT SWITCHES

B5010-007	4-Position Light Switch	\$37.99
	8 Spade Terminals, 1/2" Diameter Threaded End, (use #B5001-006 for knob) John Deere Replaces: #AR28402 Fits Diesel Models: 3010, 3020 (Up to Serial #67,999), 4010, 4020 (Diesel, Serial #65,000 to 90,999), 5010 (Up To Serial #4499), 8020	
B5010-008	4-Position Light Switch	\$43.99
	9 Spade Terminals, 1/2" Diameter Threaded End, (use #B5001-006 for knob) John Deere Replaces: #R39551, AR41288 Fits: 2510, 2520 (Up To SN: #22000), 3020 (SN: #68,000 – 150,000), 4020 (SN: #91,000 – 250,000), 4520 (Up To SN: #142449), 5010 (SN: #8000 & Up), [5020, 6030 (Without Cab)]	
B5010-009	4-Position Light Switch	\$37.99
	6 Spade Terminals, 1/2" Diameter Threaded End, (use #B5001-008 for knob) John Deere Replaces: #AR48724 Fits: [2350, 2355, 2550, 2555, 2750, 2755, 2855, 2940, 2950, 3140, 3150, 4030, 4040, 4050, 4055, 4230, 4240, 4250, 4255, 4430, 4440, 4450, 4455, 4555, 4620, 4630, 4640, 4650, 4755, 4840, 4850, 4955, 7020, 7520, 8430, 8440, 8450, 8630, 8640, 8650, 8850 (With Sound Guard Cab)], 2520 (SN 22001 & Up), 3020 (SN 150001 & Up), [4000, 4020 (SN 250001 & Up)], 4320, 4520 (SN 142450 & Up), [5020, 6030 (With Cab)]	

B5010-014	4-Position Light Switch	\$37.99
	6 Spade Terminals. 1/2" Diameter Threaded End. John Deere Replaces: #AR28401 Fits: [1010, 1020, 1520, 2010, 2020 (Gas, LP & Diesel)], 1850 (Serial #70301 & Up), 2030 (Gas, LP & Diesel Up to Serial #187300), [3010, 4010 (Gas & LP)], 3020 (Gas & LP Up to Serial #67999), 4020 (Gas & LP Serial #65000 to 90999)	

B5010-012	5-Position Light Switch	\$43.99
	5 Spade Terminals. 1/2" Diameter Threaded End. John Deere Replaces: #AR66478 Fits: [1040, 1140, 1530, 1640, 1830, 2030, 2040, 2040S, 2240, 2440, 2630, 2640, 2840, 830 3 cylinder, 920 (Gas/Diesel)], [2150, 2155, 2255, 2355, 2550, 2555, 2755, 2855, 2940, 2950 (Without Sound Guard Cab)], [3030, 3130 (Gas/Diesel SN: 162948 & up)]	

Dimmer Switches

B5005-002	Headlamp Dimmer Switch	\$19.75
	3 Spade Terminals 12 Volt OEM Cole Hersee Headlamp Dimmer Switch. Mounting Holes - 1/4"-20 Thread John Deere Replaces: #AR48725 Fits: 2520 (Serial #22,001 & Up), 3020 (Serial #123,000 & Up), 4000, 4020 (Serial #250,000 & Up), 5020 (Serial # 30,001 & Up)	

Momentary Switches

B5004-002	Momentary Pull Switch	\$31.75
	John Deere Replaces: #AB1837 Fits: A Serial #477,000 to 502,23, B Serial #60,000 to 90,999 D Serial # 143,800 186,751	

B5004-003	Momentary Push Switch	\$15.75
	Manual Push Button Solenoid Switch with Rubber Protected Cap 2 Screw Terminals Mounting Stem 5/8"-32 Thread John Deere Replaces: #R39554, AR47373, AR47374, AR46184, R39554 Fits: 940, 1040, 1140, 1550, 1640, 1654, 1750, 1850, 1854, 1950, 2040, 2140, 2150, 2250, 2350, 2355, 2450, 2510, 2550, 2555, 2650, 2750, 2755, 2850, 2855, 2940, 2950, 2955, 3020 (SN: 68,000 to 122,999), 3040, 3050, 3055, 3140, 3150, 3155, 3255, 3350, 3640, 3650, 4010, 4020 (SN: 91,000 to 200,999), 4030, 4040, 4050, 4055, 4230, 4240, 4250, 4255, 4350, 4430, 4440, 4450, 4455, 4560, 4630, 4640, 4650, 4755, 4760, 4840, 4850, 4955, 4960, 5010, 5020 (up to SN: 24,999), 5303, 5403, 5425 (models up to SN: 2631), 5603, 5605, 5620, 5625 (up to SN: 1688), 5705, 5725 (up to SN: 5047), 6010, 6020, 6030, 6100, 6110, 6120, 6130, 6200, 6205, 6210,	

6215, 6220, 6225, 6230, 6300, 6310, 6320, 6325, 6330, 6400, 6405, 6410, 6415, 6420, 6425, 6430, 6505, 6510, 6515, 6520, 6525, 6530, 6534, 6605, 6610, 6615, 6630, 6715, 6920, 7020, 7130, 7200, 7210, 7215, 7220, 7230, 7320, 7330, 7400, 7410, 7420, 7510, 7515, 7520, 7600, 7610, 7700, 7720, 7800, 7810, 7820, 7920, 8100, 8110, 8120, 8130, 8200, 8210, 8220, 8230, 8300, 8310, 8320, 8330, 8400, 8410, 8420, 8430, 8440, 8450, 8520, 8530, 8560, 8570, 8630, 8640, 8650, 8760, 8770, 8850, 8870, 8960, 8970, 9100, 9120, 9200, 9220, 9230, 9300, 9320, 9330, 9400, 9420, 9430, 9520, 9530, 9620, 9630 Industrial: 210C, 210LE, 300, 300D, 310, 310A, 310B, 310C, 310D, 310E, 310G, 310J, 310SE, 310SG, 310SJ, 315C, 315CH, 315D, 315SE, 315SG, 315SJ, 325J, 335D, 340D, 350D, 400, 410, 410B, 410C, 410D, 410E, 410G, 410J, 437D, 440A, 440B, 440C, 440D, 448D, 450C, 482C, 485E, 486E, 488E, 490D, 500, 500A, 500C, 510, 510B, 510C, 510D, 540B, 540D, 548D, 570B, 590D, 600, 610B, 610C, 640, 640D, 643H, 643K, 648D, 670B, 670C, 670CH, 670D, 670G, 670GP, 672B, 672CH, 672D, 672G, 672GP, 710B, 710C, 710D, 710G, 710J, 740, 740A, 743, 743A, 760, 760A, 762, 762A, 762B, 770B, 770BH, 770C, 770CH, 770D, 770G, 772B, 772BH, 772CH, 772D, 772G, 860, 860A, 860B, 862, 862B, 870D, 870G, 872D, 872G, 890, 890A, 903K, 903KH, 909K, 909KH, 953K, 959K		
---	--	--

B5004-006	3-Terminal Momentary Push Switch	\$16.50
	Manual Push Button Starter Solenoid Switch with Rubber Protective Cap Mounting Stem 5/8"-32 Thread John Deere Replaces: #AR1324R, AR20431, AR21219, AR21823 Fits: [530, 630, 730 (Gas, LP, All fuel)], [720, 730, 80, 820 2-cylinder, 830 2-cylinder (starting Switch)]	

B5004-007	Neutral Safety Switch	\$29.99
	Manual Push Button Safety Switch used as a Neutral Safety Switch. 2 Spade Terminals. 5/8"-32 Thread. 2.575" Total Length. For use as neutral safety switch. John Deere Replaces: #AH98872 Fits: 2010, 3010, 4010	

B5004-010	Momentary Switch	\$31.75
	Fuel Gauge Switch, 3 Terminals John Deere Replaces: #AF2171R Fits (Diesel): 70, 80, 720, 730, 820, 830	

FLASHERS

B9017-080	2-Terminal, 12-Volt Thermal Flasher	\$5.50
	12-Volt Thermal Flasher, Two Terminal John Deere Replaces: #552 Fits: 2520, 3020, 4000, 4020, 4520 Gas/Diesel	

CUTOUT RELAYS & VOLTAGE REGULATORS

Note: Due to modern battery design, voltage regulators can't be used to charge low or dead batteries. Doing so will destroy the voltage regulator and void the warranty.

B8001-001	6-Volt Cutout Relay	\$19.50
	15 Amp, Positive or Negative Ground Replaces: Autolite CB4014, C4012(9-5), C4012(9-4), C4012(9-1), R40061 John Deere - #AH975R, R40061 Delco - #265B, 265C, 265D, 265F, 265G, 265H, 265N, 265P, 266P, 266N, 5015850, 812970, 265J, 820845, 812971, 1116816, 1116755, 1116751, 1116809DR, 1842859, 1867781 Fits: John Deere - [A, AN, ANH, AW, AWH (To SN 583999)], AI, [AO, AR (To SN 271999)], [B, BN, BNH, BW, BWH, BWH40 (To SN 200999)], BI, BO, BR, [D, DI (To SN 186751)], [G, GH, GM, GN, GW (To SN 25999)], H, HN, HNH, HW, HWH, L, LA, LI, M, MC, MI, MT	

B8001-002	Electronic Cutout Relay	\$19.50
	25 Amp, Works with 6, 12, or 24 Volts. & Positive or Negative Ground Replaces: Autolite - #CB4014, C4012(9-5), C4012(9-4), C4012(9-1), R40061 Delco - #266P, 266N, 265P, 265N, 5015850, 812970, 265J, 820845, 812971, 1116816, 265G, 265H, 1116755, 1116751, 1116809DR, 265B, 1842859, 265C, 1867781, 265F, 265D John Deere - #AH975R, R40061 Fits: John Deere - [A, AN, ANH, AW, AWH (To SN 583999)], AI, [AO, AR (To SN 271999)], [B, BN, BNH, BW, BWH, BWH40 (To SN 200999)], BI, BO, BR, [D, DI (To SN 186751)], [G, GH, GM, GN, GW (To SN 25999)], H, HN, HNH, HW, HWH, L, LA, LI, M, MC, MI, MT	

6-Volt Saddle Mounted Cutout Relay (Delco Version)		
B8001-004	Premium Quality, Made in the USA	\$122.50
B8001-006	Standard Quality	\$38.59
	Cutout Relay, 25 Amp, Positive or Negative Ground. Replaces: Delco - #266P, 266N, 265P, 265N, 5015850, 812970, 265J, 820845, 812971, 1116816, 265G, 265H, 1116755, 1116751, 1116809DR, 265B, 1842859, 265C, 1867781, 265F, 265D John Deere - #AH975R, R40061 Fits: John Deere - [A, AN, ANH, AW, AWH (To SN 583999)], AI, [AO, AR (To SN 271999)], [B, BN, BNH, BW, BWH, BWH40 (To SN 200999)], BI, BO, BR, [D, DI (To SN 186751)], [G, GH, GM, GN, GW (To SN 25999)], H, HN, HNH, HW, HWH, L, LA, LI	

6-Volt Delco Type Voltage Regulator		
B8002-013	Premium Quality, USA Made	\$119.75
B8002-014	Standard Quality	\$34.75
	Positive Ground, 4 Terminals, Flat Mounting Bracket Replaces: Delco - #1116807, 1116816, 1118291, 1118308, 1118780, 1118982, 1119575, D645, D657 Prestolite - #8-291, GRX-291 Fits: John Deere - (6 Volt, Tractor Mounted) 40, 320, 330, 420, 430, 430C, 440 GAS	

6-Volt Delco Type Voltage Regulator		
B8002-011	Premium Quality, Made in the USA	\$124.75
B8002-012	Standard Quality	\$42.75
	4 Terminals, Curved Mounting Bracket Regulator, Positive Ground Replaces: Delco - #1116766, 1118265, 1118305, 1118433, 1118436, 1118790, D641, D642, D643, D647, D660, D661 Fits: John Deere - B (Serial #201,000 & Up), R	

12-Volt Delco Type Voltage Regulator		
B8002-015	Premium Quality, USA Made	\$108.50
B8002-016	Standard Quality	\$34.75
	4 Terminals, Curved Mounting Bracket/Generator Mounted, Positive or Negative Ground Replaces: Delco - #1118266, 1118306, 1118791, 1118983, 1118985, D644, D648 Fits: John Deere - A, AH, AN, AW (Serial #584,000 & Up), D (Serial #186752 & Up), G (Serial #26,000 & Up), G Series (With Generator #1101755), 50, 60, 70 (With Generator #1100955)	

6-Volt Delco Type Voltage Regulator		
B8002-025	Premium Quality, Made in the USA	\$118.25
B8002-046	Standard Quality	\$34.75
	3 Terminals, Curved Mounting Bracket Regulator, Generator Mounted Replaces: Delco - #1118786, 1972234, A617M Prestolite - #GRX-406, GRX-407 Fits: John Deere - 70 Diesel, 720 Diesel, 730 Diesel, 80, 820, 830, 840	

12-Volt Delco Type Voltage Regulator		
B8002-019	Premium Quality, Made in the USA	\$116.51
B8002-020	Standard Quality	\$34.75
	3 Terminals, Generator Mounted Delco Voltage Regulator Replaces: Delco - #1118792, 1118991, D649 Prestolite - #8-295, GRX-408 Fits: John Deere - (50, 60, 70 with Generator #1100309), 520, 530, 620, 630, 720 Gas, 730 Gas	

12-Volt Delco Type Voltage Regulator		
B8002-017	Premium Quality, Made in the USA	\$99.75
B8002-018	Standard Quality	\$34.75
	4 Terminals, Flat Mounting Bracket Regulator Tractor Mounted Replaces: Delco - #1118381, 1118779, 1118977, 1118987, 1118993, 1118997, 1118999, 1119576, D646 John Deere - #AT12649, TY1440 Prestolite - #8-290 Fits: John Deere - 435D, 440 Diesel, (1010, & 2010 All Except Generator #1102331)	

B8002-024	24-Volt Delco Type Voltage Regulator	\$114.25
	4 Terminals, Flat Mounting Bracket Regulator, Tractor Mounted John Deere Fits: 80, 720, 730, 820, 830, 840, 3010 Diesel, 3020 Diesel (Up to Serial #122,999), 4010 Diesel, 4020 Diesel (Up to Serial # 200,999), 5010 Diesel	
B8002-023	12-Volt Delco Type Voltage Regulator	\$128.65
	3Terminals, Flat Mounting Bracket Regulator, Tractor Mounted, Premium Quality USA Made Replaces: Delco #1118225, 1118286, 1118330, 1118348, 11183781, 1118905, 1118906, 1118941, 1119152, 1119153, 1119165, 1119252, 5856, D656 Fits: John Deere 1010, 2010 (All With Generator #1102331)	
B8002-029	Regulator Shock Mount Kit	\$23.95
	Used with B8002-023, -024, & more Replaces: Delco # 1910966, 1911028, 1911034, 1914863, 1915331, D32596 JD # AR11041, AR11042, AT21632 Fits John Deere 500, 600, 720 Diesel Electric Start, 730 Diesel Electric Start, 820 2 Cyl, Diesel Electric Start, 830 2 Cyl, Diesel Electric Start, 3010, 3020, 4010, 4020, 5010	
B8002-022	12-Volt Delco Type Voltage Regulator	\$91.25
	3 Terminals, Flat Mounting Bracket Regulator, Tractor Mounted, Positive or Negative Ground Premium Quality USA Made Replaces: Delco - 1118210, 1118214, 1118260, 1118273, 1118304, 1118316, 1118354, 1118857, 1118901, 1118902, 1118955, 1119135, 1119245, D616, D654 Fits: John Deere (Gas)- 3010, 3020, 4010, & 4020	
B8002-039	12-Volt Alternator Voltage Regulator	\$36.75
	4-Wire Plug, Flat-Mounting Bracket Replaces: Motorola - #5-110, 5-139, 5-146, 5-25, 5-67, 5-81, 8RB2002, 8RB2007, 8RH2004D, 8RH2004E, R2AM4, R2J1 Prestolite - #105-139, 105-146, 8-359, VSH-6201R John Deere - #AR77485, AT21815, AR48266 Fits Alternators: Motorola - #10-101, 10-102, 10-118, 10-119, 10-120, 10-30, 8AL2004F, 8AL2005F, 8AL2006F, 8AL2007F, 8AL2008K, 8AL2009K, 8AL2020L, A12NAM456, A12NAM457, A12NAM606, A12NAM607, A12NJD452, A12NJD454 Prestolite - #110-101, 110-102, 110-118, 110-119, 110-120, 110-30, 110-57 John Deere - #AT21618, AT21619, SE501350, TY1428 Fits Tractors: John Deere - 1020, 1520, 1530, 2020, 2030, 2440, 2630, 2640, 4000, 4020, 4455, 4520, 5020	

GENERATOR REPAIR KITS

10181RK	6 & 12 Volt, 3 Brush Generator Repair Kit	\$12.75
	Includes 3 Brushes, 1 Ball Bearing & 1 Bushing Fits Delco Generator #1100517, 1100955, 1101356, 1101371, 1101397, 1101385, 1101755, 1101777, 1101857 John Deere Fits: A, AO, B, BO, G, L, M, MC, MI, MT	
10222RK	6 Volt, 2 Brush Generator Repair Kit	\$11.75
	Includes 2 Brushes, 1 Ball Bearing, & 1 Bushing Fits Delco Generator #1101859 John Deere Fits: 40, 320, 330, 420, 430, 440 (Gas)	
X360	6 Volt, 3 Brush Generator Set	\$6.25
	Includes 3 Brushes Generator Mounted John Deere Fits: B (Serial #201,000 & Up), BO, BR, R	
10341RK	6 Volt, 2 Brush Generator Repair Kit	\$11.75
	Includes 2 Brushes, 1 Ball Bearing, & 1 Bushing, Tractor Mounted Fits Delco Generator #1100027 John Deere (Diesel) Fits: 70 Diesel, 720 Diesel Pony Start, 730 Diesel Pony Start, 80, 820, 830 Pony Start, 840 Pony Start	
X348	12 Volt, 3 Brush Generator Set	\$6.00
	Includes 3 Brushes, Generator Mounted John Deere Fits: A, AH, AN, AW (Serial #548,000 & Up), D (Serial #186752 & Up), G (Serial #26,000 & Up), [G (With Generator #1101755)], 50, 60, 70, (With Generator #1100955)	
10341RK	12 Volt, 2 Brush Generator Repair Kit	\$11.75
	Includes 2 Brushes, 1 Ball Bearing & 1 Bushing, Tractor Mounted Fits Delco Generator #1100309 John Deere Fits: 50 (Serial #5016058 & Up), 60 (Serial #603000 & Up), 70 Gas (Serial #7008100 & Up), 520, 530, 620, 630, 720 Gas, 730 Gas	
X270	12 Volt, 2 Brush Generator Set	\$5.00
	Includes 2 Brushes, Tractor Mounted John Deere Fits: 435D, 440 Diesel, 1010, & 2010 (All Except Generator #1102331), 3010, 3020, 4010, & 4020 Gas	

9422RK	12 & 24 Volt, 2 Brush Generator Repair Kit	\$14.75
	Includes 2 Brushes & 2 Ball Bearings Fits Delco Generator #1102102, 1103026 John Deere (Diesel) Fits: 435 (2 Cyl, Diesel), 440 (2 Cyl, Diesel), 3010 Diesel, 3020 Diesel (Up to Serial #122,999), 4010 Diesel, 4020 Diesel (Up to Serial #200,999)	

STARTER REPAIR KITS

4789RK	Delco Starter Repair Kit	\$16.75
	Includes 6 Brushes & 3 Bushings John Deere Fits: A (Up to Serial #583,999) with 6 Volt Delco Starter #1109614	

4422RK	Delco Starter Repair Kit	\$15.75
	Includes 4 Brushes & 2 Bushings John Deere Fits: 50 with Starter #1108155	

3864RK	Delco Starter Repair Kit	\$13.75
	Includes 4 Brushes & 3 Bushings John Deere Fits: 730 Gas	

4052RK	6-Volt Starter Repair Kit	\$11.75
	Includes 4 Brushes & 2 Bushings Fits 6 Volt Delco Starter #1107127 John Deere Fits: M, MC, MI, MT, 40, 320, 330 (Up To Serial #10,000), 420, 430 (Up To Serial #10,000)	

4678RK	12-Volt Starter Repair Kit	\$14.75
	Includes 4 Brushes & 3 Bushings Fits Delco 12 Volt Starters John Deere Fits: A (With starter # 1108950), 60 (with starter # 1108950, 1108989)	

4105RK	12-Volt Starter Repair Kit	\$14.75
	Includes 4 Brushes & 3 Bushings Fits 12 Volt Delco Starter #1108656 John Deere Fits: 435 (2 Cyl Diesel), 440 (2 Cyl Diesel)	

IDENTIFICATION TAGS

B9013-017	John Deere A Serial Number I.D.	\$32.99
	Size: 3 3/8" long x 1 5/8" high with rivets. Includes mounting screws. John Deere Fits: C	

Delco Remy

B9013-004	Delco Remy I.D. Tag (Blank)	\$7.00
	Delco Remy I.D. Tag (Stamped)	\$14.25
	Black Delco-Remy I.D. Tag for Distributors, 6 Volt Starters, & 6 Volt Generators with Rivets, 3/4" 2 5/16"	

B9013-005 Red	Delco Remy I.D. Tag (Blank)	\$7.00
	Delco Remy I.D. Tag (Stamped)	\$14.25
	Red Delco-Remy I.D. Tag for 12 Volt Starters & 12 Volt Generators with Rivets, 3/4" 2 5/16"	

B9013-006 Orange	Delco Remy I.D. Tag (Blank)	\$7.00
	Delco Remy I.D. Tag (Stamped)	\$14.25
	Orange Delco-Remy I.D. Tag for 24 Volt Starters, & 24 Volt Generators with Rivets, 3/4" 2 5/16"	

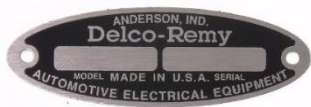
B9013-013	Delco Remy I.D. Tag (Blank)	\$7.00
	Delco Remy I.D. Tag (Stamped)	\$14.25
	Black Delco-Remy I.D. Tag for Distributors, 6 Volt Starters, & 6 Volt Generators with Rivets, 3/4" 2 5/16"	

ALTERNATORS

B6001-001	12 Volt Alternator (1 Wire)	\$112.75	
63 Amp, Low Cut In, Specially Built For Tractors, Forklifts, & Other Low Engine Speed Applications			

B6001-002	12 Volt Alternator (1 Wire/3 Wire)	\$118.75
63 Amp, with 1 Wire Or 3 Wire For Warning Lamp On Automobiles & Trucks		

B6001-005	6 Volt Alternator (1 Wire, Positive Ground)	\$166.50
6 Volt, 40 Amp with Positive Ground, 1 Wire, 3/8" pulley		

Small ND Type

B6002-003	12 Volt Small Denso Alternator (1-Wire)	\$119.75
	40 Amp, 1 Wire Internal Regulator. Will Start Charging with a Much Lower Engine Speed. Comes with a 4 1/2" Housing Diameter, 3/8 To 1/2" Belt width & a 2 1/2" Pulley Diameter. Excellent for Converting a 6 Volt System to 12 Volt. Negative Ground Only & is Self-Excited	

ALTERNATOR BRACKETS

B9014-011	Alternator Mounting Bracket Adapter, Wiring, & Pulley Kit (Diesel Only)	\$69.75
------------------	--	----------------



Used to Convert from a Generator to an Alternator with Original Alternator Mounting Bracket & Top Adjusting Arm

John Deere Fits Diesel Only: 3010, 3020 (Up to Serial #122,999), 4010, 4020 (Up to Serial #200,999)

B9014-014	Alternator Mounting Bracket Kit (Gas Only)	\$49.75
------------------	---	----------------



Converts from Generator to Alternator, with Original Alternator Mounting Bracket & Top Adjusting Arm
John Deere Fits (Gas Only): 3010, 3020 (Up to Serial #122,999), 4010, 4020 (Up to Serial #200,999)

VOLTAGE CONVERSION KITS

B9021-001	24-Volt to 12-Volt Alternator Conversion Kit	\$498.50
------------------	---	-----------------



Converts the following John Deere Tractors from original 24-Volt Generator System to a 12-Volt Alternator System.

Includes: 12-Volt Starter, 12-Volt Alternator with correct pulley, Alternator

Mounting Bracket Adaptor, Generator Light Harness, Alternator-to-Starter Wire, Starter Relay, & Step-by-step Instructions. *Uses Original Alternator Mounting Bracket & Top Adjusting Arm.

Fits John Deere Diesel Models: 3010, 3020 (Up to Serial # 122,999), 4010, 4020 (Up to Serial # 200,999)

Note: This Kit Contains Some Conversion Wiring for the Generator Light and Alternator to Starter connection.

All other wiring needed must be made on site.

For a Factory Fit, Use the Following Wire Harnesses:

#B3028-139, B3028-141, B3028-150, B3028-170, B3028-171, B3028-190, B3028-192, B3028-195, B3028-197, B3028-199, B3028-205, B3028-206, B3028-276, B3028-278, B3028-288, B3028-295, B3028-297

COMPLETE STARTERS

4393N	Starter for John Deere Gas Tractors	\$314.75
--------------	--	-----------------



Call for Availability New, 20MT, DD, 12-Volt, CW Rotation, 9 Teeth

Replaces: **John Deere:** #AR11161, AR11305, AT15335, TY1456, TY26007, TY6694

Delco: #1107522, 1107546, 1107578, 1109145, 12301338

Fits **John Deere:** 3020 4-240 Gas 1969-1972, 4000 360 Gas 1969-1972, 4020 341 Gas & LPG 1963-1968, 4020 360 Gas 1969-1972, 6602 362 Gas Combine 1973-1974, 500C Diesel Engines 1977-1982, 510 Industrial Tractor 1982, 4010 Utility Tractor 302 Gas & LPG 1962

6570N	Upgrade Starter for John Deere (Gear Reduction Starter)	\$197.50
--------------	--	-----------------



New, Replaces:

John Deere: #AR66424, AT18025, AT18150, AT25619, RE19187, RE50095, TY6614, TY6702, TY1465, TY6639, TY6706, TY1458, TY25994, TY6620

Delco: #323-652, 323-672, 1107339, 1108319, 1109421, 1107577, 1107599, 1107863, 1107871, 1113271, 12301329,

1109251, 10461443, 12301485

Fits **Industrial-** 300 (1965-1974), 300B Loader (1974-1983), 301 (1971-1973), 301A (1965-1985), 302 (1974-1981), 302A (1974-1981), 302A Backhoe (1974-1981), 310 (1971-1986), 310A Backhoe (1976-1983), 310A (1971-1986), 310B (1971-1986), 350 (1965-1970), 350B (1970-1975), 350B Loader (1970-1975), 350C Crawler/Dozer (1975-1981), 350C (1975-1981), 355 (1975-1981), 400 (1965-1971), 401 (1974-1981), 401 Loader (1971-1973), 401A (1974-1981), 401B (1974-1981), 401C Backhoe (1974-1982), 401C (1974-1981), 401C Loader (1974-1981), 401D (1971-1981), 410 Backhoe (1974-1984), 410 (1971-1982), 410B (1971-1982), 440C Loader 4 Cyl. (1976-1984), 450 (1965-1970), 450B (1970-1973), 450B Loader (1970-1973), 450C Crawler/Dozer (1974-1981), 450C (1974-1981), 455D Crawler/Dozer (1982-1985), 480A (1965-1982), 480B (1965-1982), 480C (1965-1982), 540 (1972-1982)

Utility Tractors- 820 3-Cyl (1968-1972), 830 3-Cyl (1972-1975), 920 (1970-1975), 1020 Diesel (1965-1973), 1520 Diesel (1968-1973), 1530 Diesel (1974-1975), 2030 Diesel (1971-1975), 2040 Diesel (1972-1985), 2240 Diesel (1976-1982)

Farm Tractors - 1630 (1973-1982), 1640 (1970-1982), 1830 (1973-1982), 1840 (1970-1982), 2020 Diesel (1965-1972), 2030 All (1970-1979), 2040 (1976-1982), 2440 (1976-1982), 2510 (1965-1968), 2520 (1967-1973), 2630 (1974-1975), 2640 (1976-1982), 276 Diesel (1976-1982), 2840 (1977-1979)

Combines with Diesel Engines - 3300 (1971-1977), 4400 (1970-1982), 4420 (1980-1986), 45 Self-Propelled (1966-1970), 55 Self-Propelled (1967-1970), 95 Self-Propelled, 6600 All (1973-1977) JD24 Skid Steer Diesel 1970-1976

***NOTE: the 1-Year Warranty is Void unless a relay is installed** (use solenoid #B5007-003 to function as a relay).

6576N	Starter for John Deere Diesel Tractors (Gear Reduction Starter)	\$197.50
--------------	--	-----------------



New, Delco 28MT, 12 Volt, 10 Teeth, CW Rotation, Starter-Mounted Solenoid Included (but see below)

Replaces:

Delco - #10461450, 10461451, 10465049, 10465050, 1107350, 1107522, 1107578, 1107785, 1109147,

1113148, 1113190, 1113281, 1113282, 1113402, 1113672





John Deere - #AR11138, AR11300, AR11305, AR28053, AR40134 (12-volt), AR55638, AR60085, AR62267, SE501414, SE501446, TY6710, TY6713, TY25960

Fits: **John Deere** (Diesel) - 3010, 3020 (Up to Serial # 122,999), 4010, 4020 (Up to Serial # 200,999), 4320

***NOTE: the 1-Year Warranty is Void unless a relay is installed** (use solenoid #B5007-003 to function as a relay).

STARTER SWITCHES/ SOLENOIDS

B5006-003	Saddle Mount Lever Switch	\$11.75
	Lever or Rod operated, 6 or 12 Volt, Starter Mounted Manual Push Button Starter Switch Has Bracket for Rocker Lever Replaces: Delco - #1872403, 1872405, 1882323, 1918405, 1919576, 1919600, 1925781, 1918405, 1919578, 1919600, 1923480, 1925781, 1932131, 1940047, D903, D904, D905, D908, D909, John Deere - #1882323, AT21265 Fits: John Deere - B (Up to Serial #200,999), AO (Up to Serial #271,999), H, L, LA, LI, M, MC, MI, MT, 40, 320, 420, 430, 440 (With Push/Pull Rod)	
B5006-004	Starter Switch	\$11.75
	6- or 12- Volt Starter Mounted Manual Push Button Starter Switch John Deere Replaces: D202, 820052, 1954976 Fits: A (SN: 502,232 & up), AO (SN: 272,000 & up), AR (SN: 272,000 & up), B (SN: 201,000 & up), G, R, 50, 60, 70	
B5006-005	12 Volt Manual Push Starter Switch	\$17.50
	Starter Mounted Manual Push Switch with Side Terminal for Bypass Start Fits starters: #1107188, 1107634, 1113004, 1113005, 1113041, 1113304 Replaces: John Deere - #1934779, AR11115R, 1928209, AR11006R Delco - #D906, 1930496, 1930505 Fits: John Deere - 50 (SN #5021480 & up), 60 (SN #6030000 & Up), (60, 70 (Propane), 70 (Diesel Up to SN #7031299), 520, 620, 620 (Orchard Up to SN #6,222,999), 720	
B5007-001	6 Volt Starter Solenoid	\$17.50
	3 Terminal Solenoid with Curved Bracket Fits: John Deere - 70 Diesel (Late With Push Button Starting), 720 Diesel Pony Start, 730 Diesel Pony Start, & 820 Diesel Pony Start	
B5007-032	12-Volt Delco Solenoid	\$27.50
	For Delco Starters with 4 Terminals. Face-Mounted. Additional Mounting Parts Included. Replaces: Delco - 1114458 John Deere - AT11342T Fits: John Deere - 435, 440 Diesel with Delco Starter - 1108656	
B5007-028	24-Volt Delco Starter Solenoid	\$49.75
	Replaces: John Deere Starters - #AR11138, AR28053, AR40134, SE501445, TY1470, TY2622, TY2666, TY6703 John Deere Tractors - 500, 600, 3010D, 3020D (up to Serial #122,999), 4010D, 4020D (up to Serial #200,999)	

B5007-004	12 Volt Solenoid	\$23.75
	Has a Curved Bracket & 4 Terminals (Used with 30 & 35 MT Delco Starters) Replaces Delco - #1119890, 1119912, 1119885, 1119877, 1119935, 1119882, 1119906, D953, D985, 1119833, 1119883, 1115537, 1119978, 1115582, 1119778, 1115508, 1115529, 1115540, 1115501 John Deere - #AT11593, AR11050, AR11049, R11292 Fits: John Deere - 620 (Orchard Models with SN #6,223,000 & Up), 630, 730 (Gas & LP), 3020 (Diesel Models SN #123,000 & Up), [4000, 4030, 4230, 4320, 4430, 4520, 4620, 4630, 7020, 8430, 8630 (Using Delco Starter #1113672 & 1113402)], 4020 (Diesel Models SN #201,000 & Up using Delco starters #1113672 & 1113402)	
B5007-033	12-Volt Delco Solenoid	\$19.75
	12-Volt Rated Solenoid for Delco Starters with 4 Terminals. Has a 2 Hole Mount. Additional Mounting Parts Included. Replaces: Delco - #1114557, 1114569, D907A, D991 Fits Delco Starters: #10455008, 10455009, 10455045, 10455046, 10455058, 10465030, 10465039, 10465099, 10465100, 10495524, 10496524, 1109546, 19136207, 19136207, 19136216, 19136216, 1998476, 1998509, 1998512, 1998534, 1998542, 1998550	
B5007-016	12 Volt Bosch Solenoid	\$31.75
	12 Volt Rated Solenoid for Bosh Starters with 2 Terminals. Has a Crimped Cap & 3 Hole Mount. Replaces: Bosch - #0331401011, 0331401013, 0331401026, 0331401035, 0331401038, 0331401040, 0331402001, 0331402016, 0331402019, 0331402023, 0331402030, 0331402035, 0331402039, 0331402087, 0331402205, 0331402501, 0331402504, 0331402519, 0331402535, 0331402539, 2339402150 John Deere - #AL41524, AL25266, AL55046 Fits: John Deere - 1020, 1030, 1040, 1120, 1130, 1140, 1155, 1530 (Serial #152930 & Up), 1630, 1640, 1830, 1840, 2020, 2030, 2040, 2120, 2130, 2140, 2150, 2155, 2240, 2250, 2255, 2350, 2355, 2355N, 2450, 2550, 2555, 2750, 2755, 2840, 2855, 2855N, 2940, 2950, 2955, 3030, 3040, 3055, 3120, 3130, 3140, 3150, 3155, 3255, 3640, 840, 920, 930, 940, 955	
B5007-019	Denso 12 Volt Starter Solenoid	\$32.75
	12 Volt Rated Solenoid for Denso Direct Drive Starters with 3 Terminals. Replaces: Denso - #046500-0010, 053400-1560, 053400-1720, 053400-2740, 053400-2870, 053400-3450, 053400-3490, 053400-3570, 053400-4530, 053400-6030, LA046500-0010 John Deere - #AR54991, AR55498, AR71256, AR90070, AR90074, RE13732 Fits: John Deere - 3020, 4000, 4020, 4030, 4040, 4050, 4055, 4230, 4240, 4250, 4255, 4320, 4350, 4430, 4440, 4450, 4455, 4520, 4555, 4560, 4620, 4630, 4640, 4650, 4755, 4760, 4840, 4850, 4955, 4960, 7020, 7700, 7710, 7800, 7810, 8100, 8200, 8300, 8430, 8440, 8450, 8560	

B5007-020	John Deere Bosch 12 Volt Solenoid	\$41.25
	3 Terminals for Bosch Starters. Replaces: Bosch - #0331400023, 0331401001, 0331401003, 0331401004, 0331401012, 0331401029, 0331401046, 0331401051, 0331401501, 0331401503, 0331401504, 0331402073, 0331402074 John Deere - AL19192 Fits: John Deere – 820, 830, 920, 1020, 1120, 1530 (Up to Serial #152929), 1830, 2020, 2030, 2120, 2130, 3030, 3120, 3130	

B5007-039	12 Volt Bosch Starter Solenoid	\$33.25
	12 Volt Rated Solenoid for Bosh Starters with 3 Terminals. Has a Crimped Cap & 3 Hole Mount. Additional Mounting Parts Included. John Deere Fits: 820, 830, 920, 1020, 1140, 1530, 1830, 2020, 2030, 2120, 2130, 3030, 3120, 3130	

B5007-047	12-Volt Prestolite Solenoid	\$21.50
	12 Volt Rated Solenoid for Prestolite Starters with 4 Terminals. Additional Mounting Parts Included. Replaces: John Deere - AT40955, AT68973, RE170320, RE38391 Prestolite - 15-274, 15-360, 15-391, 15-418, 15-441, SAZ4201AW, SAZ4201BR, SAZ4201CJ, SAZ4201R Fits: John Deere - (various)	

B5011-003	Start Switch Lever	\$18.99
	Replaces: #M1863T Fits: John Deere – 40, 320, 420, & 440 Gas	

LIGHTS & LIGHT PARTS

B9016-003	7" Flat Lens Type Head Lamp	\$99.99
	6-Volt Head & Clear Rear Lamp (Can be used as 12-Volt by Changing Bulb) John Deere Replaces: #AB3144R, AB3144R, AB3145R Fits: A (Serial #477,000-500,011), B (Serial #60,000- 95,999), D (Up to Serial #188057)	

PARTS FOR LIGHT ABOVE		
Headlamp & Parts are interchangeable with original except as noted		
B9017-002	7" Lens With Guide Name	\$21.99
B9017-003	7" Clamp Ring	\$17.99
B9017-005	7" Gasket	\$8.99
B9017-006	7" Reflector *Call for Availability*	\$16.50
B9017-067	7" Light Terminal	\$6.00

Table continues at top of next column.

B9017-013	6 Volt Bulb Fits Reflector Above, Not Original	\$3.00
	Pack of 10	\$25.50
B9017-015	12 Volt Bulb Fits Above Reflector, Not Original	\$3.00
	Pack of 10	\$25.50

Headlight Assembly		
B9016-016	Bullet Type 6 Volt Head	\$54.99
B9016-082	Bullet Type 12 Volt Head	\$54.99
	John Deere Replaces: #AL2855T, AM3257T, AT10571T Fits: A (Styled with Cast Iron Dash Up to SN 584000), B (Styled with Cast Iron Dash Up to SN 200999), G, L, LA, M, [M, MC, MI, MT (Works as a Rear Light)], MT, 40, 320 (Early), 420 (Up to SN #100000)	

PARTS FOR LIGHT ABOVE		
B9017-056	4 3/4" Lens with Guide Name	\$14.99
B9017-057	4 3/4" Clamp Ring (Black)	\$15.99
B9017-058	4 3/4" Gasket	\$3.99
B9017-004	4 3/4" Reflector	\$14.99
B9017-067	4 3/4" Light Terminal	\$6.00
B9017-013	6 Volt Bulb Replaces #AA3495R, AA3495R, AB2820R	\$3.00
	Pack of 10	\$25.50
B9017-015	12 Volt Bulb	\$3.00
	Pack of 10	\$25.50
B9017-070	Light Bracket Clamp	\$8.99
	John Deere Fits: M, MC, MT, 40, 320, 330, 420, 430, 435, 440, 1010, 2010 (Crawler), 3010, 3020 Replaces: #M1482T	

B9017-138	Mounting Clamp Half (#R27460)	\$11.99
------------------	--------------------------------------	----------------

Headlight Assembly		
B9016-040	Bullet Type 6 Volt Head	\$53.99
B9016-041	Bullet Type 12 Volt Head	\$53.99
	John Deere Fits: A, B, D, G, H, R, 50, 60, 70, 70D, 80	

PARTS FOR LIGHT ABOVE		
B9017-056	4 3/4" Lens with Guide Name	\$14.99
B9017-057	4 3/4" Clamp Ring (Black)	\$15.99
B9017-058	4 3/4" Gasket	\$3.99
B9017-004	4 3/4" Reflector	\$14.99
B9017-067	4 3/4" Light Terminal	\$6.00
B9017-013	6 Volt Bulb	\$3.00
	Pack of 10	\$25.50
B9017-015	12 Volt Bulb	\$3.00
	Pack of 10	\$25.50

B9016-004	12 Volt Sealed Beam Head Light	\$49.99
 <p>John Deere Fits: 820 2 cylinder Electric start (Serial #8203100 & Up), 620 Standard & Orchard (Serial #6213100 & Up), 630 Standard, 720 Diesel Electric Start (Serial #7222600 & Up), 720 Gas Standard (Serial #7214900 & Up), 730 Gas (Standard & LP, & All-fuel) Replaces: #AF710R, AF3816R</p>		

John Deere Sealed Beam Head Light		
B9016-030	6 Volt	\$49.99
B9016-031	12 Volt	\$88.95
 <p>John Deere Fits: 320 (Late), 330, 420 (Serial #100001 & Up), 430, 440 Gas Replaces: #AT10571T</p>		



PARTS FOR LIGHT ABOVE		
B9017-031	Sealed Beam, 12 Volt High Beam	\$18.99
B9017-032	Sealed Beam, 12 Volt Low Beam	\$16.50
 <p>4 1/2" diameter John Deere Fits: 320, 330, 420 (Serial #100,001 & Up), 430, 440</p>		

Sealed Beam Head Lamp Assembly for Cowl & Flat Fender Lights		
B9016-034	6 Volt, Low Beam	\$54.99
B9016-036	12 Volt, Low Beam	\$54.99
 <p>6/12 Volt Low Beam Head Lamps John Deere Fits: 520, 530, 620, 630, 720, 730 Gas & Diesel (with Cowl or Flat Top Fenders) 820 2 cylinder (SN #8,203,100 & Up with sealed beam lights), 830 2 cylinder (With sealed beam lights) Replaces: #AR20446R (6 Volt, Low Beam), #AA7322R (12 Volt, Low Beam)</p>		

PARTS FOR LIGHT ABOVE		
B9017-036	6-Volt Sealed Beam Bulb	\$14.50
 <p>30-Watt, Double Contact, 4.5" Diameter, Low Beam John Deere Replaces: #AF3893R GE: #4511 Fits: Diesel with Pony Start: 730, 720 Pony Start 6-Volt: 820 2-cylinder, 830 2-cylinder</p>		

Sealed Beam Head Lamp Assembly for Flat Top Fenders		
B9016-035	6 Volt, High Beam	\$54.99
B9016-037	12 Volt, High Beam	\$54.99
 <p>6/12 Volt High Beam Head Lamps John Deere Fits: 530, 630, 730 Gas & Diesel (with Flat Top Fenders) 820 2 cylinder (SN #8,203,100 & Up with Sealed Beam Lights), 830 2 cylinder (With Sealed Beam Lights) Replaces: #AR20445R (6 Volt, High Beam), #AR20443R (12 Volt, High Beam)</p>		

PARTS FOR LIGHT ABOVE		
B9017-031	Sealed Beam, 12 Volt High Beam	\$18.99
B9017-035	Sealed Beam, 6 Volt High Beam	\$17.99
 <p>4 1/2" diameter John Deere Fits: 320, 330, 420 (Serial #100,001 & Up), 430, 440</p>		
		B9017-009 \$5.99
Concave Light Mounting Washer/Retainer		

B9017-097	12-Volt LED Lamp, Trapezoid Beam Pattern	\$49.99
 <p>John Deere Replaces: #AF3892R, AT11898, RE285629, RE336112, RE561117 Fits: 24, 99, 299, 340D, 440A, 440B, 440C, 440D, 500, 500A, 500B, 510, 510B, 520, 530, 540, 540A, 540B, 540D, 548D, 550, 550A, 550B, 555, 555A, 555B, 570A, 600, 620, 630, 644A, 644B, 644C, 646, 646B, 646C, 699, 720, 730, 740, 740A, 743, 743A, 760, 790, 820 2 cylinder, 820 3 cylinder, 830 2 cylinder, 830 3 cylinder, 855, 870, 920, 930, 940, 950N, 955, 970, 1010, 1020, 1030, 1040, 1070, 1120, 1130, 1140, 1520, 1530, 1550, 1630, 1640, 1641, 1641F, 1750, 1840, 1850, 1850N, 11950, 2010, 2020, 2030, 2040, 2040S, 2120, 2130, 2140, 2141, 2150, 2155, 2240, 2250, 2251, 2251N, 2255, 2350, 2351, 2355, 2355N, 2440, 2450, 2510, 2520, 2541, 2550, 2555, 2630, 2640, 2650, 2651, 2750, 2755, 2840, 2850, 2855, 2855N, 2940, 2941, 2950, 2951, 2955, 3010, 3020, 3030, 3040, 3050, 3055, 3130, 3140, 3141, 3150, 3155, 3255, 3350, 3641, 4000, 4010, 4020, 4030, 4040, 4040S, 4050, 4055, 4230, 4240, 4240S, 4250, 4255, 4320, 4350, 4430, 4440, 4450, 4455, 4520, 4555, 4560, 4620, 4630, 4640, 4650, 4755, 4760, 4840, 4850, 4955, 4960, 5010, 5020, 6030, 7020, 7440, 7520, 8430, 8440, 8450, 8560, 8570, 8630, 8640, 8650, 8760, 8770, 8850, 8870, 8960, 8970, 9100, 9200, 9300, 9300T, 9400, 9400T</p>		
		B9017-139 \$44.75
24-Watt Sealed Hi-Lo Work Light Tractor LED Bulb		
John Deere Fits: 4020 (late)		

B9017-098	12-Volt LED Lamp, Flood Beam Pattern	\$49.99
	<p>John Deere Replaces: #AE31263, AR104119, AR21059, AT25451, H7606, RE285628, RE336111, RE35168, RE561116 GE: #4410, 4411 Fits: 520, 530, 620 Standard/ Orchard Gas/LP (sn 6213100 and up), 630, 720, 720 Standard Diesel electric start (sn 7222600 and up), 720 Rowcrop Diesel electric start (sn 7222600 and up), 730 Gas/LP/All-fuel Standard, 820 2 cylinder electric start (sn 8203100 and up), 830 2 cylinder, 1040, 1140, 1640, 1750, 1850, 1850N, 1950, 1950N, 2010, 2040, 2040S, 2140, 2150, 2155, 2240, 2250, 2255, 2350, 2355, 2440, 2450, 2510, 2520, 2550, 2555, 2650, 2750, 2755, 2840, 2850, 2855N, 2940, 2950, 2955, 3010, 3020, 3050, 3055, 3140, 3150, 3155, 3255, 3350, 4000, 4010, 4020, 4030, 4040, 4040S, 4050, 4055, 4230, 4240, 4240S, 4250, 4255, 4320, 4350, 4430, 4440, 4450, 4455, 4520, 4555, 4560, 4620, 4630, 4640, 4650, 4755, 4760, 4840, 4850, 4955, 4960, 5010, 5020, 6030, 7020, 7520, 8430, 8440, 8450, 8560, 8570, 8630, 8640, 8650, 8760, 8770, 8850, 8870, 8960, 8970, 9100, 9200, 9300, 9300T, 9400, 9400T Industrials: 340D, 350, 350B, 350C, 350D, 401D, 440D, 440C, 444, 444C, 444D, 450, 450B, 450C, 450D, 450E, 455D, 455E, 480C, 500, 500A, 500B, 540B, 544, 544A, 544B, 544C, 544D, 550, 550A, 550B, 555, 555A, 555B, 570, 570A, 600, 640, 644A, 644B, 644C, 644D, 646, 646B, 700, 740, 740A, 743, 743A, 760, 760A</p>	

Sealed Beam Head Lamp Assembly for Flat Top Fenders		
B9016-022	12 Volt Low Beam	\$39.99
B9016-023	12 Volt High Beam	\$59.75
B9016-080	12 Volt LED Trapezoid	\$67.99
B9016-081	12 Volt LED Flood Light	\$67.99
	<p>John Deere Fits: 1020, 1520, 1530, 2010, 2020, 2030, 2040, 2240, 2350, 2355, 2510, 2520, 2550, 2555, 2630, 2640, 2750, 2755, 2840, 2940, 2950, 3010, 3020, 4000, 4010, 4020, 4030, 4230, 4320, 4430, 4520, 4620, 4630, 5010, 5020, 6030, 7020, 7520</p>	

PARTS FOR LIGHT ABOVE		
B9017-031	Sealed Beam, 12 Volt High Beam	\$18.99
B9017-032	Sealed Beam, 12 Volt Low Beam	\$16.50
	<p>4 1/2" diameter John Deere Fits: 320, 330, 420 (Serial #100,001 & Up), 430, 440</p>	
	B9017-009	\$5.99
Concave Light Mounting Washer/Retainer		

Bullet Type Work/ Tail Light with Switch		
B9016-021	6 Volt	\$79.99
B9016-018	12 Volt	\$79.99
	<p>Combo/Red Dot Tail Lamp with mounting stud John Deere Replaces: #AA4762R Fits: A (Serial #477000 - 583999), AO, & AR (Serial #272000 & Up), B (Serial #96000 - 200999), D (Serial #186752 & Up), G (Serial #13000 - 25999), H (Serial #27,000 & Up)</p>	

PARTS FOR LIGHT ABOVE		
B9017-056	4 3/4" Lens with Guide Name	\$14.99
B9017-059	4 3/4" Clamp Ring (Red)	\$15.99
B9017-058	4 3/4" Gasket	\$3.99
B9017-007	4 3/4" Reflector	\$21.99
B9017-067	4 3/4" Light Terminal	\$6.00
B9017-010	Light Switch Assembly	\$18.50
B9017-013	6 Volt Bulb	\$3.00
	Pack of 10	\$25.50
B9017-015	12 Volt Bulb	\$3.00
	Pack of 10	\$25.50
B9017-037	6 Volt Miniature Bulb	\$1.25
B9017-039	12 Volt Miniature Bulb	\$1.25
B9017-066	Red Dot Jewel Lens Assembly	\$17.99
B9017-077	Rear Combo Light Switch with Knob (3 Screw Terminals)	\$18.50

B9017-081	John Deere Light Clamp	\$7.99
	<p>7/8" Light Clamp for John Deere Lights. John Deere Replaces: #A2613R Fits: A (Styled models up to SN: 583999 with cast iron dash), B (Styled models up to SN: 200999 with cast iron dash), G (SN: 13000 & up for rear light only), H, [60, 620, 630 (Standard & Orchard)], 8020 (Used as an oil level pipe clamp)</p>	

Bullet Type Combo/Red Dot Tail Lamp with Switch		
B9016-032	6 Volt	\$79.99
B9016-033	12 Volt	\$83.99
	<p>Mounts On Back Of Seat John Deere Replaces: #AB4037R, AB3976R, AB3975R, AA3075R, AA4529R Fits: A (Serial #584,000 & Up), B (Serial #201,000 & Up), G (Serial #26,000 & Up), R</p>	

PARTS FOR LIGHT ABOVE		
B9017-056	4 3/4" Lens with Guide Name	\$14.99
B9017-057	4 3/4" Clamp Ring (Black)	\$15.99
B9017-058	4 3/4" Gasket	\$3.99
B9017-007	4 3/4" Reflector	\$21.99
B9017-067	4 3/4" Light Terminal	\$6.00
B9017-010	Light Switch Assembly	\$18.50
B9017-013	6 Volt Bulb	\$3.00
	Pack of 10	\$25.50

B9017-015	12 Volt Bulb	\$3.00
	Pack of 10	\$25.50
B9017-037	6 Volt Miniature Bulb	\$1.25
B9017-039	12 Volt Miniature Bulb	\$1.25
B9017-066	Red Dot Jewel Lens Assembly	\$17.99

John Deere Tail Light		
B9016-008	6 Volt	\$45.99
B9016-011	12 Volt	\$45.99
	Restoration Quality 6 or 12 Volt Chrome Rear Lamp with 2 1/8" O.D. Red Glass Lens. Includes base Gasket John Deere Fits: A (Serial #584000 & Up), B (Serial #201000 & Up), G (Serial #26000 & Up), M, MI, MT, R	

Rear & Head Work Light Without Red Dot		
B9016-027	6 Volt	\$69.99
B9016-026	12 Volt	\$69.99
	Mounts on Back of Seat John Deere Replaces: #AB3549R, AA3867R Fits (as rear worklight) – A (12v only), B (6v or 12v), G (12v only, SN: 26000 & up), R (6v or 12v) (as headlamp on early models) - 520, 620, 720 (Gas & Diesel)	

PARTS FOR LIGHT ABOVE		
B9017-095	Tail Light Gasket	\$2.99

John Deere Combination Tail & Rear Work Light Assembly		
B9016-028	6 Volt	\$72.50
B9016-029	12 Volt	\$75.99
	John Deere 6 Volt Fits: 40, 320, 330, 420, 430 Replaces: #AT10569 12 Volt Fits: [435, 440 (All)], When converted to 12 volt: 40, 320, 330, 420, 430; Replaces: #AT11352T, AM1980T	

PARTS FOR LIGHT ABOVE		
B9017-056	4 3/4" Lens with Guide Name	\$14.99
B9017-057	4 3/4" Clamp Ring (Black)	\$15.99
B9017-058	4 3/4" Gasket	\$3.99
B9017-004	4 3/4" Reflector	\$14.99
B9017-067	4 3/4" Light Terminal	\$6.00
B9017-013	6 Volt Bulb	\$3.00
	Pack of 10	\$25.50
B9017-015	12 Volt Bulb	\$3.00
	Pack of 10	\$25.50
B9017-037	6 Volt Miniature Bulb	\$1.25
B9017-039	12 Volt Miniature Bulb	\$1.25

B9016-076	12-Volt LED Round Fender & Cab Warning Light	\$54.99
	One side is an amber lens; the other is amber & red. 5 3/4" Outer Diameter., 25 LED's, 10-30 Volts John Deere Replaces: #AR50580 Fits: 820 (3-cylinder; SN: 77,054 and up), 830 (3-cylinder), 850 (up to SN: 1444), 1020 (SN: 117,500 and up), 1030, 1520 (SN: 117,500 and up), 1530, 2020 (SN: 117,500 and up), 2030, 2040, 2130, 2150, 2240, 2350, 2355, 2440, 2520 (SN: 22,001 and up), 2550, 2555, 2630, 2640, 2750, 2755, 2840, 2940, 2950, 3020 (SN: 150,001 and up), 4000, 4020 (SN: 250,001 and up), 4320, 4620, 5020 (SN: 30,001 and up), 6030 Industrials: 300, 300B, 301, 301A, 302, 302A, 380, 401, 401B, 401C, 401D, 480A, 480B, 480C	

Combo/Red Dot Tail Lamp Assembly		
B9016-025	6 Volt	\$59.95
B9016-024	12 Volt	\$62.99
	John Deere Replaces: #AA5199R, AA6733R, AR26574, AR21735R, Washer: #B2295R, F2935R, Light: #AA6733R Fits: 50, 60, 70, 70 Diesel, 80, 520, 530, 620, 630, 720, 720 Diesel, 730, 730 Diesel, 820 (2-cylinder), 830 (2-cylinder), 3010 Standard (up to SN: 19,799), 4010 (up to SN: 22,908)	

B9016-054	Round Fender & Cab Mount Warning Light	\$19.99
	Restoration Quality 12-Volt Round Light with Two 4" Diameter Amber Lenses, Double Contact Bulb, 1/2" Diameter Stud, & 2.4" Thick at Widest Point. John Deere Replaces: #AA34967, AR38456, AT22066, AT23467 Fits (serviceable): 820 (3-cylinder), 830 (3-cylinder), 1020, 1520, 1530, 2010, 2020, 2030, 2040, 2240, 2440, 2510, 2520, 2630, 2640, 2840, 2940, 3010, 3020, 4000, 4010, 4020, 4030, 4040, 4050, 4055, 4230, 4240, 4250, 4255, 4320, 4430, 4440, 4450, 4455, 4520, 4555, 4560, 4620, 4630, 4640, 4650, 4755, 4760, 4840, 4850, 4955, 4960, 5010, 5020, 6030, 7020, 7520, 8430, 8440, 8450, 8630, 8640, 8650, 8850 Industrial (serviceable): 300, 301, 302, 400, 401, 402	

PARTS FOR LIGHT ABOVE		
B9017-056	4 3/4" Lens with Guide Name	\$14.99
B9017-057	4 3/4" Clamp Ring (Black)	\$15.99
B9017-058	4 3/4" Gasket	\$3.99
B9017-007	4 3/4" Reflector	\$21.99
B9017-067	4 3/4" Light Terminal	\$6.00
B9017-013	6 Volt Bulb	\$3.00
	Pack of 10	\$25.50
B9017-015	12 Volt Bulb	\$3.00
	Pack of 10	\$25.50
B9017-037	6 Volt Miniature Bulb	\$1.25
B9017-039	12 Volt Miniature Bulb	\$1.25
B9017-066	Red Dot Jewel Lens Assembly	\$17.99

B9016-055	Rectangular Fender & Cab Mount Warning Light	\$32.99
	Restoration Quality 12-Volt Rectangular Light One Red and One Amber Lens With Amber Side Marker 4.5" Wide & 1/2" Diameter Stud John Deere Fits: Various Models	

B9017-115	LED Combination Rear Light Bulb, Red/White, Sealed Beam	\$49.99
	Flood Pattern, 18 Watts, 1200 Lumens, Can Be Switched to White or Red Light John Deere Replaces: AR21737, AR77324 Fits 4 1/2" O.D. Housing with Either Metal or Rubber Bezel	

Sealed Beam Fender Light for Flat Top Fenders

B9016-057	12 Volt, Inner, High Beam	\$61.99
B9016-058	12 Volt, Outer, Low Beam	\$61.99

	John Deere Replaces: #AT13380, AT13381 Fits (with flat top fenders): 530, 630, 700A, 2010 (rowcrop), 2510, 2520 (up to SN: 22,000), 2630, 3010, 3020, 4000, 4010, 4020, 4520, 5010, 5020, 6030	
---	---	--

B9016-060	12-Volt Sealed Beam Rear Combo Light (Hobbs Style)	\$74.99
------------------	---	----------------

	Restoration Quality, Rubber Bezel. John Deere Replaces: #AR28227, AR34990, AR77323, AR77326, AT16288 Fits: 820 (3-cylinder), 830 (3-cylinder), 1010, 1020, 1120, 1520, 1530, 1630, 1630, 2010, 2020 Orchard, 2040, 2150, 2155, 2240, 2350, 2355, 2440, 2510, 2520, 2550, 2555, 2630, 2640, 2750, 2755, 2840, 2940, 2950, 3010, 3020, 4000, 4010, 4020, 4320, 4520, 4620, 5010, 5020 (Serial #260501 & Up): 830 (3-cylinder, European), 2030, 2130 (Serviceable for); 2010	
--	---	--

PARTS FOR LIGHT ABOVE

B9017-031	Sealed Beam, 12 Volt High Beam	\$18.99
B9017-032	Sealed Beam, 12 Volt Low Beam	\$16.50

	4 1/2" diameter Double Contact Light Bulb 4.365" Outside Diameter	
--	---	--

PARTS FOR LIGHT ABOVE

B9017-069	Sealed Beam, 12 Volt Bulb	\$19.99
------------------	---------------------------	----------------

	Combination Rear Lamp w/ transparent red background using separate bulb Replaces: AR21737, AR77324	
--	---	--

	B9017-009	\$5.99
Concave Light Mounting Washer/Retainer		

B9017-115	LED Combination Rear Light Bulb, Red/White, Sealed Beam	\$49.99
------------------	--	----------------

(See listing above for details.)

B9017-118	Hobbs Style Light Bezel	\$14.99
------------------	--------------------------------	----------------

Rubber, slides over outside, for front/ rear light assemblies

B9016-059	John Deere 12 Volt Sealed Beam Rear Combo Light	\$66.95
------------------	--	----------------

	Restoration Quality 12-Volt Rear Combination Light. Has 4 1/2" Sealed Beam Light with Rubber Bezel. 2 Terminals on Back of Light with Threaded Post on Bottom of Housing. John Deere Replaces: #AR28227, AR34990, AR77323, AR77326, AT16288 Fits: 1010, 1130, 1530, 1830, 2020 (Orchard), 2040, 2240, 2440, 2510, 2520, 2630, 2640, 2840, 2940, 3010, 3020, 3030, 3040, 3130, 3140, 4000, 4010, 4020, 4320, 4520, 4620, 5010, 5020, 6030 (Up to Serial #260500): 830 (3-Cylinder), 1630, 2030, 2130 (Serviceable for); 1020, 1520, 2010	
--	---	--

B9016-079	John Deere 12-Volt Sealed Beam Front/ Rear Light (Hobbs Style)	\$74.99
------------------	---	----------------

	4 1/2" diameter sealed beam, 3/4" mounting stud length, 4.775" O.D. rubber bezel, 5.275" O.D. Bottom threaded post with 1 wire thru the threaded post. John Deere Replaces: #AR28167, AR35782, AT12935, AT20106, RE27099 Fits: 500 Industrial, 820 (3-Cylinder), 1010, 1020, 1120 (up to SN: 152,399), 1520, 1530, 2010, 2020 (European), 2030, 2130 (up to SN: 1,523,990), 2440, 2630, 2640	
--	--	--

INDIVIDUAL LIGHT PARTS

PARTS FOR LIGHT ABOVE







B9017-069	Sealed Beam, 12 Volt Bulb	\$19.99
------------------	---------------------------	----------------







	Combination Rear Lamp w/ transparent red background using separate bulb Replaces: AR21737, AR77324	
---	---	--

B9017-088	Lamp Socket, Tellight	\$14.75
------------------	------------------------------	----------------

	Used as a wiring lead in various tractors and industrial applications. John Deere Replaces: #AT44165 Fits: 301A, 302, 400, 401, 401B, 401D, 1020, 1520, 1530, 2020, 2030, 2040, 2150, 2155, 2240, 2255, 2350, 2355, 2440, 2510, 2520, 2550, 2555, 2630, 2640, 2750, 2755, 2840, 2855N, 2940, 2950, 2955, 3010, 3020, 3055, 3150, 3155, 3255, 4000, 4010, 4020, 4030, 4040, 4050, 4055, 4230, 4240, 4250, 4255, 4320, 4430, 4440, 4450, 4455, 4520, 4555, 4560, 4620, 4630, 4640, 4650, 4755, 4760, 4840, 4850, 4955, 4960, 5010, 5020, 6030, 7520, 8430, 8440, 8450, 8570, 8630, 8640, 8650, 8770, 8850, 8870, 8955, 8970	
--	---	--

Wiring Harnesses, Battery Cables, & Spark Plug Wires, Proudly Made in the USA!

B9017-128	Indicator Lamp Spring	\$2.50
	John Deere Replaces: #R30378 Fits: 300B, 1010, 1020, 1520, 1530, 2010, 2020, 2030, 2440, 2510, 2520, 2630, 2640, 3010, 3020, 4000, 4010, 4020, 4320, 4520, 4620, 5010, 5020, 6030, 7020, 7520	
B9017-137	Amber Indicator Lamp Bulb (14v)	\$1.99
B9017-136	Clear Indicator Lamp Bulb (12v)	\$1.25
B9017-129	Red Indicator Lamp Bulb (12v)	\$1.99
	John Deere Replaces: #AR50439, 1895A (Amber) #AM31284, 1895 (Clear) #AR55694, 1895R (Red) Fits: (see bulb listings for lenses below)	
B9017-126	Oil Pressure Warning Lens	\$14.99
	1.078" Long, 0.646" Outside Diameter. John Deere Replaces: #AR28552, AR45437, AR48035, AR65447, AT17816, AT22038, AT48674, R27944 Fits: 301A, 302, 400, 401, 401B, 401D, 1020, 1520, 1530, 2020, 2030, 2040, 2150, 2155, 2240, 2255, 2350, 2355, 2440, 2510, 2520, 2550, 2555, 2630, 2640, 2750, 2755, 2840, 2855N, 2940, 2950, 2955, 3010, 3020, 3055, 3150, 3155, 3255, 4000, 4010, 4020, 4030, 4040, 4050, 4055, 4230, 4240, 4250, 4255, 4320, 4430, 4440, 4450, 4455, 4520, 4555, 4560, 4620, 4630, 4640, 4650, 4755, 4760, 4840, 4850, 4955, 4960, 5010, 5020, 6030, 7520, 8430, 8440, 8450, 8570, 8630, 8640, 8650, 8770, 8850, 8870, 8955, 8970 Bulb: #B9017-129 (Red)	
B9017-127	Generator Indicator Lens	\$14.99
	1.056" Long, 0.646" Outside Diameter. John Deere Replaces: #AR26915, AT22037 Fits: 301A, 302, 400, 401, 401B, 401D, 1020, 1520, 1530, 2020, 2030, 2040, 2150, 2155, 2240, 2255, 2350, 2355, 2440, 2510, 2520, 2550, 2555, 2630, 2640, 2750, 2755, 2840, 2855N, 2940, 2950, 2955, 3010, 3020, 3055, 3150, 3155, 3255, 4000, 4010, 4020, 4030, 4040, 4050, 4055, 4230, 4240, 4250, 4255, 4320, 4430, 4440, 4450, 4455, 4520, 4555, 4560, 4620, 4630, 4640, 4650, 4755, 4760, 4840, 4850, 4955, 4960, 5010, 5020, 6030, 7520, 8430, 8440, 8450, 8570, 8630, 8640, 8650, 8770, 8850, 8870, 8955, 8970 Bulb: #B9017-129 (Red)	
B9017-131	Air Cleaner Restriction Indicator Lens	\$14.99
	1.056" Long, 0.646" Outside Diameter. John Deere Replaces: #AR45439, AR48033 Fits: 2520, 3020 (Serial #123,000 and up), 4000, 4020 (Serial #201,000 and up), 4320, 4520, 4620, 5020 (Serial #25,000 and up), 6030, 7020, 7520 Bulb: #B9017-129 (Red w/ JD 2520, 3020), #B9017-137 (Amber w/ JD 4000 and up)	
B9017-133	Power Shift Filter Indicator Lens	\$14.99
	1.056" Long, 0.646" Outside Diameter. John Deere Replaces: #AR45446, AR48032 Fits: 2520, 3020 (SN: 123,000 and up), 4000, 4020 (SN: 201,000 and up), 4520, 4620 Bulb: #B9017-129 (Red)	

B9017-134	High Beam Indicator Lens	\$14.99
	1.100" Long, 0.646" Outside Diameter. John Deere Replaces: #AR47916 Fits: 2520, 3020 (Serial #123,000 and up), 4000, 4020 (Serial #201,000 and up), 4320, 4520, 4620, 5020 (Serial #25,000 and up), 6030, 7020, 7520 Bulb: AR50440, 1895B (Blue)	
B9017-135	Alternator Indicator Lens	\$14.99
	1.056" Long, 0.646" Outside Diameter. John Deere Replaces: #AH45438, AR45438, AT48673 Fits: 1520, 1530, 2020 (SN: 82,404 & up), 2030, 2040, 2040 Utility, 2240, 2350, 2355, 2440, 2520, 2555, 2630, 2640, 2750, 2755, 2755 (GPT), 2840, 2940, 2950, 3020 (SN:123, 000 & up), 4000, 4020 (SN: 201,000 & up), 4030, 4040, 4050, 4055, 4230, 4250, 4255, 4240, 4320, 4430, 4440, 4450, 4455, 4520, 4620, 4630, 4640, 4650, 4840, 4850, 5020 (SN: 24,039 & up), 6030, 7020, 7520, 8430, 8450, 8630, 8650, 8850 Bulb: # B9017-137 (Amber), Remote Control #B9017-129 (Red)	
B9017-101	Light Mounting Bracket	\$47.99
	John Deere Replaces: #M2201T Fits (w/ Touch-O-Matic hydraulics): 40 (Standard and Utility), 320 & 330, 420 & 430 (Standard and Utility only), 1010 (Single Rowcrop, up to SN: 42,000 without dual hydraulics. Also fits Orchard, Grove and Utility.)	
B9017-103	Light Arm	\$22.99
	John Deere Replaces: #M647T, T11022T Fits: M, MC, MT, 40, 320, 330, 420, 430, 435, 440, 1010	
B9017-104	Rear Light Adjusting Arm	\$65.99
	Used to Attach Front & Rear Light Rods John Deere Replaces: # AM481T Fits: M	
B9017-105	Light Support Bracket	\$36.99
	John Deere Replaces: #M646T Fits: M, MC, MT, 40, 320, 420 (up to Serial # 139,999), 440 (Wheel Tractors without Touch-O-Matic)	
B9017-106	Screw & Jam Nut	\$3.99
	Used to Attach Front & Rear Light Rods John Deere Replaces: #14H611A & 22H724A Fits: M, MC, MT, 40, 320 (up to Serial #139,999), & 420 (up to Serial # 139,999)	
B9017-018	12-Volt Light Bulb	\$1.10
John Deere Replaces: #AD2062R		
OEM Replaces: #1156		

DASH LAMPS

B9016-014	Black Finish Dash Lamp	\$19.75
------------------	-------------------------------	----------------



6- or 12-Volt, Black Finished Dash Lamp. Bulb not included.

6-Volt: use Bulb #B9017-046

12-Volt: use Bulb #B9017-049

John Deere Replaces: #AR33479R, RE13195R, AR35993R AD2835R, AR26757R, B1728R, AR1563R,

AR20447R, AD2834R, AD1855R, AD2082R

Fits: AR, B, BR, D (Styled), R, 50, 60, 70 (Hi-Crop), 70, 70 (Diesel), 80, 520 (Gas/All Fuel), 820 2 Cylinder, 830 2 Cylinder (Pony and Electric Start), 1010, 2510, 3010, 3020, 4010, 4020, 5010, 5020, 5030, 8020

B9017-046	6 Volt Bulb	\$1.25
------------------	--------------------	---------------

B9017-049	12 Volt Bulb	\$1.25
------------------	---------------------	---------------



Light bulbs for product #B9016-014 above.

B9016-043	Black Finish Dash Lamp	\$39.99
------------------	-------------------------------	----------------



12-Volt, Bulb not Included. Purchase Bulb #B9017-049 if needed.

John Deere

Replaces: #AR20466R, AR2051R, AF3139R

Fits: 520 (LP), [530, 630, 730 (Upper Dash Lamp)], 620 (Except Orchard), 720, 720 (DSL; Electric Start), 730 (Dsl; Upper Dash Lamp on the Electric Start)

Black Finish Dash Lamp

B9016-056	6 Volt	\$32.99
------------------	---------------	----------------

B9016-042	12 Volt	\$32.99
------------------	----------------	----------------



6- or 12-Volt, Bulb not Included. Stand-alone bulbs #B9017-046 & #B9017-049 are fitted for this part.

John Deere

Replaces: #AR20432R, 10A14558, 10A23061, 10A14796, 10A14803,

AM1879T, AR20432R

Fits (6-Volt): 40, 320, 330, 420, 430

(When converted or originally 12-Volt): 40, 50, 60 Orchard/Standard, 60 Rowcrop, 70 Standard, 320, 330, 420, 430, 435, 440, [530, 630 (Lower Dash Lamp)], 620 (Orchard), 730 (Lower Dash Lamp for Gas)

B9017-046	6 Volt Bulb	\$1.25
------------------	--------------------	---------------

B9017-049	12 Volt Bulb	\$1.25
------------------	---------------------	---------------



Light bulbs for products #B9016-042, #B9016-056 above

B9017-036	6-Volt Sealed Beam Bulb	\$14.50
------------------	--------------------------------	----------------



30-Watt, Double Contact, 4.5" Diameter, Low Beam

John Deere Replaces: #AF3893R GE: #4511

Fits: Diesel with Pony Start: 720, 730 Pony Start 6-Volt: 820 2-cyl, 830 2-cyl

B9017-083	John Deere Front Light Clamp	\$16.99
------------------	-------------------------------------	----------------



John Deere

Fits: G

Replaces: #F718R

Quick Disconnect Terminal

B9004-043	GM Quick Disconnect		
	John Deere Fits: A, B, D		



Qty 1-9	\$4.20	Qty 100-499	\$2.73
Qty 10-25	\$3.36	Qty. 500-999	\$2.42
Qty 26-99	\$3.05	Qty. 1000+	\$2.10

AUXILIARY PLUG & SOCKET

B9032-001	2 Pole Auxiliary Plug	\$23.75
------------------	------------------------------	----------------



John Deere

Replaces:- #AM2049T, AR33479R,

RE13195R, AR35993R

Fits: 820 2 cylinder, 830 2 cylinder (Pony & Electric Start), AR, B, BR (with Electric Start), D (Styled), R, 50 (Up to SN

#5016122), 60 (Up to SN #6017060), 70

(Hi-Crop; Up to SN #7006327), 70 (Up to SN #7006327), 70 (Diesel), 80, 520 (Gas/All-Fuel; Up to SN #5208099), 1010, 2510, 3010, 3020 (Up to SN #122999), 4010, 4020 (Up to SN #200999), 5010, 5020, 5030, 8020

B9032-002	2 Pole Auxiliary Connector	\$19.75
------------------	-----------------------------------	----------------



(Used With B9032-001)

Replaces: **John Deere** - #AR33479R,

RE13195R, AR35993R

Fits: **John Deere** - Fits: 820 2 cylinder, 830 2 cylinder (Pony & Electric Start), AR, B, BR (with Electric Start), D (Styled), R, 50 (Up to SN #5016122), 60 (Up to SN #6017060), 70 (Hi-Crop; Up to SN #7006327), 70 (Up to SN #7006327), 70 (Diesel), 80, 520 (Gas/All-Fuel; Up to SN #5208099), 1010, 2510, 3010, 3020 (Up to SN #122999), 4010, 4020 (Up to SN #200999), 5010, 5020, 5030, 8020

CIGARETTE LIGHTERS

B9030-001	6 Volt Cigarette Lighter	\$29.99
------------------	---------------------------------	----------------



Anodized Aluminum Knob Engraved with the word Lighter

John Deere Replaces: - #AM1949T,

AR20440R, AR101220

Fits: [820 2 cylinder, 820 2 cylinder (Pony Start Tractors with 6 Volt System)], [40, 80, 420, 430 (With 6 Volt System)], [70, 720, 730 (Diesel Tractors with Pony start & 6 Volt System)], 440 (Gas Tractors with 6 Volt System)

B9030-002	12 Volt Cigarette Lighter	\$29.99
------------------	----------------------------------	----------------



Anodized Aluminum Knob Engraved w/ the word Lighter

John Deere Replaces: #AT26407, AR60937,

AA5734R, AR21327, AR20438R, AA5787R,

AR30052, AR34556, AR48643, AR46079

Fits: Models with 12 Volt Electrical Systems

CARBURETOR REBUILD KITS

B9022-001	Marvel Schebler Repair Kit	\$29.99
	<p>John Deere Tractors Model A, A-WT, AN, ANH, AO, AR-AO, AW, AWH, B, BN, BNH, BO, BR, BW, BWH, D, G, GP, NT, WT Fits Carburetor:</p> <p>Marvel-Schebler: #DLTX-5, DLTX-6, DLTX-8, DLTX-10, DLTX-11, DLTX-12, DLTX-13, DLTX-15, DLTX-16, DLTX-17, DLTX-18, DLTX-19, DLTX-24, DLTX-31, DLTX-33, DLTX-34, DLTX-39, DLTX-41, DLTX-51, DLTX-53, DLTX-63, DLTX-67, DLTX-71, DLTX-72, DLTX-73, DLTX-107U, DLTX-108U</p> <p>John Deere: #AA-200-R, AA-580-R, AA-2498-R, AA3117-R, AA-3154-R, AA3950-R, AA-4056-R, AB-237-R, AB2711-R, AB-3470-R, AB-3533-R, AC-610, AC-610-R, AC-999-R, AC-1081, AC-1082, AD-830, AD-975, AD-2544-R, AF-240-R, AF-570-R, AF-571-R, AF-731-R</p>	

B9022-039	Marvel Schebler Repair Kit	\$6.99
	<p>John Deere Tractors Model A, AI, AO, AR, B, D, G Fits Marvel-Schebler Carburetor: # DLTX-6, DLTX-7, DLTX-8, DLTX-10, DLTX-11, DLTX-12, DLTX-13, DLTX-15, DLTX-16, DLTX-17, DLTX-18, DLTX-19, DLTX-24, DLTX-31, DLTX-33, DLTX-34, DLTX-38, DLTX-39, DLTX-41, DLTX-51, DLTX-53, DLTX-63, DLTX-71, DLTX-72, DLTX-73</p>	

B9022-037	Comprehensive Repair Kit	\$114.99
	<p>John Deere Tractors Model (using DLTX71 and DLTX72 carburetors) - A Late, AO Late, AR Late, AR Late, 60 All-Fuel (to to SN: 6013899) Fits John Deere Carburetors:# 12H64R, 15-223, 21H962R, 21H971R, 21H994R, 321R, A765R, AR10018R, AR10020R, AR10021R, AR10058R, AR10063R, AR10075R, AR10077R, DI034R, R10014R, R10024R, R10025R, R10026R, R10045R, R10049R, R10050R, R10055R, R10057R, R10063R, R10067R, R10076R, R10078R, R10079R, R10090R, R10093R, R10095R, R10096R, R10104R, R10108R, R10114R, R10116R, R10139R, R10147R, R10149R, R10151R, R10163R, R10172R</p>	

B9022-023	Marvel Schebler Repair Kit	\$24.50
	<p>John Deere Tractor Model L, LA, LI, LUC, 1010 Fits Carburetor:</p> <p>Marvel-Schebler: #1004SL, TSX13, TSX101, TSX102, TSX103, TSX112, TSX113, TSX114, TSX119, TSX120, TSX126, TSX128, TSX132, TSX132A, TSX133, TSX134, TSX136, TSX137, TSX138, TSX140, TSX141, TSX142, TSX144, TSX146, TSX147, TSX148, TSX150, TSX151, TSX154, TSX155, TSX156, TSX157, TSX159, TSX161, TSX167, TSX171, TSX173, TSX179, TSX180, TSX182, TSX183, TSX184, TSX186, TSX188, TSX189, TSX190, TSX191, TSX192, TSX193, TSX194, TSX197, TSX198, TSX202, TSX203, TSX206, TSX206-1, TSX211, TSX212, TSX225, TSX228, TSX231, TSX237, TSX239, TSX239-1, TSX240, TSX241A, TSX241B, TSX241C, TSX246, TSX248, TSX253, TSX254, TSX258, TSX260, TSX264, TSX266, TSX267, TSX269, TSX272, TSX274, TSX278, TSX282, TSX280, TSX286, TSX287, TSX288, TSX289, TSX292, TSX290, TSX297, TSX30, TSX301, TSX305, TSX306, TSX308, TSX309, TSX312, TSX314, TSX315, TSX319, TSX322, TSX323, TSX326, TSX328, TSX33, TSX330, TSX331, TSX332, TSX333, TSX334, TSX335, TSX338, TSX339, TSX34, TSX341, TSX346, TSX347, TSX348, TSX35, TSX351, TSX352, TSX356, TSX357, TSX358, TSX359, TSX36, TSX361, TSX361-A, TSX363, TSX366, TSX367, TSX368, TSX37, TSX370, TSX370-1, TSX377, TSX38, TSX380, TSX388, TSX389, TSX39, TSX391, TSX398, TSX400, TSX403, TSX405, TSX406, TSX407, TSX409, TSX418, TSX419, TSX42, TSX420, TSX421, TSX422, TSX423, TSX428, TSX43, TSX44, TSX443, TSX447, TSX448, TSX45, TSX450, TSX452, TSX453, TSX455, TSX458, TSX459, TSX465, TSX470, TSX472, TSX474, TSX48, TSX480, TSX481, TSX484, TSX486, TSX49, TSX497, TSX500, TSX507, TSX510, TSX513, TSX514, TSX516, TSX518, TSX520, TSX525, TSX531, TSX532, TSX534, TSX539,</p>	

<p>TSX54, TSX541, TSX55, TSX551, TSX552, TSX556, TSX558, TSX560, TSX567, TSX569, TSX570, TSX573, TSX577, TSX58, TSX580, TSX589, TSX59, TSX593, TSX595, TSX597, TSX60, TSX603, TSX605, TSX606, TSX611, TSX614, TSX618, TSX626, TSX633, TSX635, TSX643, TSX646, TSX649, TSX649-1, TSX650, TSX653, TSX655, TSX656, TSX660, TSX663, TSX665, TSX668, TSX670, TSX671, TSX676, TSX680, TSX681, TSX683, TSX69, TSX690, TSX691, TSX692, TSX694, TSX696, TSX701, TSX706, TSX709, TSX710, TSX714, TSX730, TSX736, TSX74, TSX742, TSX744, TSX748, TSX753, TSX76, TSX762, TSX765, TSX767, TSX770, TSX771, TSX776, TSX776-1, TSX78, TSX781, TSX787, TSX79, TSX793, TSX796, TSX80, TSX802, TSX803, TSX804, TSX809, TSX812, TSX815, TSX820, TSX826, TSX827, TSX83, TSX830, TSX841, TSX844, TSX85, TSX851, TSX855, TSX857, TSX860, TSX862, TSX864, TSX865, TSX866, TSX879, TSX88, TSX882, TSX89, TSX896, TSX896SL, TSX90, TSX901, TSX91, TSX912, TSX913, TSX914, TSX919, TSX926, TSX930, TSX931, TSX936, TSX936SL, TSX937, TSX937SL, TSX94, TSX948, TSX949, TSX95, TSX954, TSX957, TSX957SL, TSX95A, TSX96, TSX971, TSX976, TSX978, TSX979, TSX979-1, TSX98, TSX983, TSX986, TSX987, TSX99, TSX990, TSX991, TSX991-1, TSX996, TSXU828, TSXU829, TSXU830, TSXU831, TSXU832, TSXU833, TSXU834, 1003</p> <p>John Deere: #AL20225T, AL20290T, AL2283T, AL2630T, AL2848T, AL2849T, AL2850T, AL2851T, AL2859T, AL2958T, AT11963T, AT12743T, AT12903T, AT16332T, AT-20225-T, AT-20290-T, ATY-5045-F, PP21819</p>

B9022-005	Marvel Schebler Repair Kit	\$23.99
	<p>John Deere Tractors Model M, MC, MT, 40, 300, 320, 330, 350, 400, 420, 430, 440, 450, 461, 501, 561, 1020, 1520, 2010, 2020, 2500, 2510, 2520 Fits Marvel-Schebler Carburetor: TSX1001, TSX1002, TSX181, TSX221, TSX245, TSX296, TSX332, TSX360, TSX374, TSX397, TSX413, TSX414, TSX436, TSX464, TSX466, TSX475, TSX492, TSX505, TSX506, TSX506A, TSX526, TSX528, TSX530, TSX561, TSX562, TSX563, TSX575, TSX582, TSX592, TSX596, TSX602, TSX605, TSX606, TSX610, TSX615, TSX633, TSX639, TSX641, TSX645, TSX648, TSX662, TSX678, TSX688, TSX689, TSX695, TSX704, TSX711, TSX713, TSX719, TSX721, TSX725, TSX732, TSX737, TSX738, TSX755, TSX756, TSX757, TSX759, TSX768, TSX769, TSX772, TSX773, TSX775, TSX777, TSX784, TSX788, TSX791, TSX792, TSX797, TSX798, TSX799, TSX800, TSX801, TSX806, TSX808, TSX810, TSX811, TSX813, TSX814, TSX816, TSX819, TSX825, TSX836, TSX843, TSX849, TSX853, TSX854, TSX856, TSX857, TSX867, TSX869, TSX871, TSX877, TSX878, TSX881, TSX883, TSX884, TSX885, TSX886, TSX888, TSX889, TSX892, TSX892S, TSX893, TSX894, TSX895, TSX897, TSX898, TSX899, TSX900, TSX902, TSX903, TSX904, TSX904SL, TSX905, TSX905-1, TSX905SL, TSX906, TSX906SL, TSX907, TSX907SL, TSX908, TSX908SL, TSX911, TSX917, TSX920, TSX920SL, TSX921SL, TSX922, TSX922SL, TSX923, TSX923SL, TSX925, TSX927, TSX928, TSX932, TSX932SL, TSX933, TSX934, TSX934SL, TSX938, TSX938SL, TSX939, TSX940, TSX940SL, TSX941, TSX941SL, TSX942, TSX943, TSX944SL, TSX945SL, TSX946, TSX947SL, TSX949, TSX950, TSX952, TSX952SL, TSX955, TSX959, TSX959SL, TSX961, TSX961SL, TSX962, TSX962SL, TSX964SL, TSX965SL, TSX966, TSX967SL, TSX968SL, TSX97, TSX972, TSX973, TSX974, TSX974SL, TSX975, TSX975SL, TSX977, TSX980, TSX980SL, TSX984SL, TSX985, TSX985SL, TSX988, TSX989, TSX993, TSX994, TSX997, TSX998, TSX999, TSXU1006, TSXU1007, TSXU835, TSXU836, TSXU840, TSXU904, TSXU904SL, TSXU905, TSXU905-1, TSXU944SL, TSXU963, TSXU9631, TSXU995</p> <p>Replaces: John Deere - #AT-18036-T, AT-18093-T, AT-18110-T, AT-21184-T, AT-21185-T, AT-21186-T, AT-21729, AT-21784, AT-21785, AT-21786, AT-21787, AT-21848, AT-22994, AT-23000, AT-23013, AT-29295, AT-29427, AT-29427-T, AF-12357-T, AM-366-T, AM-1613-T, AM-1794-T, AM-2067-T, AT-10181-T, AT-10576-T, AT-11680-T, AT-12357-T, AT-21142-T, ATY-7708-T, ATY-20956-B, SM-3061-T, SM-3227, SM-3611-T, SM-3612-T</p>	

B9022-015	Marvel Schebler Repair Kit	\$29.99
	<p>John Deere Tractor Models 50, 60, 70, 520, 530, 620, 630, 720, 730 Fits Marvel-Schebler Carburetor: #DLTX75, DLTX81, DLTX82, DLTX83, DLTX84, DLTX85, DLTX86, DLTX94, DLTX95, DLTX96, DLTX97, DLTX98, DLTX99, DLTX101, DLTX102, DLTX105, DLTX106, DLTX109</p>	

B9022-036	Premium/ Comprehensive Repair Kit	\$69.99
 <p>John Deere Tractor Models 2010 Fits Carburetor: Marvel-Schebler: #TSX810, TSX899</p>		

B9022-003	Marvel Schebler Repair Kit	\$24.99
 <p>John Deere Tractors Model 4030 Fits Carburetor: Marvel-Schebler: #TSX-969SL John Deere: #AR-59986</p>		

CARBURETOR FLOATS

B9023-008	Marvel-Schebler Carburetor Float	\$23.99
 <p>2.700" O.D., 1.729" I.D., .931" Tall Replaces: Marvel-Schebler Carburetor: #DLTX-10, DLT13, DLTX-15, DLTX-17, DLTX-18, DLTX-19, DLTX-24, DLTX-34, DLTX-39, DLTX-41, DLTX-51, DLTX-53, DLTX-63. DLTX-107U, DLTX-108U John Deere: #AR10066R Marvel Schebler: #30-635 Fits John Deere: A, A-WT, AN, ANH, AO, AR-AO, AW, AWH, B, BN, BNH, BO, BR, BW, BWH, D, G, GP</p>		

B9023-009	Marvel-Schebler Carburetor Float	\$32.50
 <p>2.700" O.D., 1.729" I.D., .925" Tall Replaces: Marvel-Schebler Carburetor: #DLTX 13, DLTX45, DLTX 60, DLTX 67, DLTX 71, DLTX 72, DLTX 73, DLTX 85, DLTX 89, DLTX 90, DLTX 91, DLTX860 John Deere: #AR10068R Marvel Schebler: #30-700 Fits John Deere: A, AO, AR-AO, B</p>		

B9023-003	Marvel-Schebler Carburetor Float	\$12.75
 <p>Replaces: Marvel-Schebler Carburetor: #TSX 13, TSX45, TSX60, TSX85, TSX89, TSX90, TSX91, TSX237, TSX356, TSX450, TSX516, TSX532, TSX753, TSX802, TSX809, TSX812, TSX860, TSXU828, TSXU829, TSXU830, TSXU831, TSXU832, TSXU833 John Deere: #AT12743T Marvel Schebler: #30-600 Fits John Deere: L, LA, LI, LUC, 1010</p>		

B9023-014	Marvel-Schebler Carburetor Float	\$29.95
 <p>Replaces: Marvel-Schebler Carburetor: #DLTX101, DLTX102, DLTX105, DLTX106, DLTX109U, DLTX75, DLTX81, DLTX82, DLTX83, DLTX84, DLTX85, DLTX86, DLTX94, DLTX95, DLTX96, DLTX97, DLTX98, DLTX99 John Deere: #AA4353R, AA5656R, AA6632R, AA6633R, AB4636R, AB4794R, AB5150R, AB5151R, AF1561R, AF1632R, AF2826R, AF2827R, AR10069, AR10069R Marvel Schebler: #30-713 Fits John Deere: 50, 520, 530, 60, 620, 630, 70, 720, 730</p>		

B9023-004	Marvel-Schebler Carburetor Float	\$19.95
 <p>Replaces: Marvel-Schebler Carburetor: #TSX 245, TSX475, TSX530, TSX562, TSX615, TSX641, TSX678, TSX688, TSX689, TSX704, TSX711, TSX737, TSX756, TSX768, TSX777, TSX788, TSX806, TSX 808, TSX810, TSX819, TSX877, TSX881, TSX883, TSX885, TSX888, TSX892, TSX894, TSX895, TSX898, TSX899, TSX904, TSX904SL, TSX905, TSX905-1, TSX906, TSX906SL, TSX907, TSX907SL, TSX908, TSX908SL, TSX920, TSX920SL, TSX921, TSX921SL, TSX922, TSX922SL, TSX923, TSX23SL, TSX938, TSX938SL, TSX941, TSX941SL, TSX944SL, TSX945SL, TSX952, TSXU963, TSXU835, TSXU836 Replaces: John Deere: #AT21411. Marvel Schebler: #30-739 Fits John Deere: L, LA, LI, LUC, 1010</p>		

B9023-015	Zenith Carburetor Float	\$24.99
 <p>John Deere Tractors Model 40, 420, 430, 2030, 4030 (Industrial)- 440 Replaces:Zenith: #C85-115, C85-115S Fits Carburetor: (various- see webpage)</p>		

CARBURETOR ACCESSORIES

B9038-003	Carburetor Elbow Fuel Line Fitting with Strainer	\$7.99
 <p>1/8" Pipe to 1/4" Flare. Works with Carter UT Series and Various Marvel-Schebler Carburetors. Fits: John Deere - A, B, G, M, 50, 60, 70, 630, 730, 4020, AI, AOS, AR, BO, BR, D, GP, GPO, H, L, LA, MC, 40, 80, 320, 330, 420, 430, 435, 520, 530, 620, 720, 820 2 cyl, 820 3 cyl, 830 2 cyl, 830 3 cyl, 840, 1010, 1020, 1520, 1530, 2010, 2020, 2030, 2510, 2520, 2630, 3010, 3020, 4000, 4010, 4025, 4030, 4230, 4330, 4430, 5420, 4620, 4630, 5010, 5020, 6030, 7020, 7520, 8020, 8430, 8630</p>		

B9038-006	Packing, 3-Way Valve	\$3.95
	<p>0.865" outside diameter, 0.485" inside diameter, 0.250" thick. Composed of graphite / graphalon infused (impregnated) cork.</p> <p>John Deere Replaces: #D2122R Fits: 50, 60, 70, 520, 530, 620, 630, 720, 730. [Styled with 3-way valve] H, HN, HNH, HW, HWH</p> <p>[Unstyled & Styled with 3-way valve] A, AH, AI, AN, ANH, AO, AOS, AR, AW, AWH, B, BI, BN, BNH, BO, BR (SN: 325,000 & up), BW, BWH, BWH40, D (SN: 30,400-143,799 & 148,872-191,777), DI, G (SN: 1000-59,701), GH, GM, GN, GP, GW</p>	

B9038-007	2" Sediment Bowl Gasket	\$2.19
	<p>2" Outer Diameter, Bowl to Body; Fits a 1.28" Tall Glass Bowl</p> <p>John Deere Replaces: L886T Fits: L, LA, M, MC, MI, MT, 40, 320, 330, 420, 430, 440 (gas only), 1010 (Rowcrop, all serial numbers and crawler up to SN: 15782, using/ 1.280" long glass bowl)</p>	

FUEL SYSTEM ACCESSORIES

B9038-009	Fuel Cap	\$10.99
	<p>Chrome Plated, 2.7" Outside Diameter, 1.88" Overall Tab Length, .25" Tab Width</p> <p>John Deere Replaces: AF2914R, AT20911, AT28483 Fits: 50 (SN: 5,018,450 & up), 60 (SN: 6,035,350 & Up), 70 (Gas, SN: 7,012,350 & Up), 320, 330, 420, 430, 435, 500, 820 (3-cylinder), 830 (3-cylinder), 1010, 1020, 1520, 1530, 2010, 2020, 2030, 2040 (up to SN: 349,999), 2240 (up to SN: 349,999), 2440, 2510, 2520, 2630, 2640, 2840, 3010, 3020, 4000, 4010, 4020, 4030, 4040, 4050, 4230, 4240, 4250, 4320, 4430, 4440, 4450, 4455, 4520, 4620, 4630, 5010</p>	

FUEL SEDIMENT BOWLS

B9036-001	Fuel Sediment Bowl	\$27.99
	<p>Has a 3/8" Pipe Inlet and a 1/8" Pipe Outlet. Bowl is 1.280" Long. Shallow Bowl has 90° Outlet Only.</p> <p>John Deere Replaces: #AM3100T, AM706T, AT326991 Fits: M, MC, MI, MT, 1010 (Rowcrop all serial numbers and crawler up to SN: 15782), 320, 330, 40, 420, 430, 440 (Gas Only)</p>	

B9036-004	Sediment Bowl Assembly	\$34.99
	<p>Has a 2.315" long bowl with a 3/8" NPT fuel inlet and a 5/16" compression outlet. Includes one fuel line fitting for a 5/16" line.</p> <p>John Deere Replaces: #AA5334R Fits: [all-fuel only] A (SN: 697757 & up), AO (SN: 280850 & up), AR (SN: 280850 & up), B (SN: 305247 & up), D (SN: 191178 & up), G (SN: 59702 & up), 50, 60, 70, 520, 530, 620, 630, 720, 730 [diesel only] 2010 (up to SN: 29000)</p>	

B9036-002	Fuel Sediment Bowl	\$34.99
	<p>Has a 3/8" Pipe Inlet, 1/8" Pipe Outlet, and a 2.315" tall glass bowl</p> <p>John Deere Replaces: #AA4295R, AA4331R Fits: (Can Also Use When Switching From Automatic Shut Off Or A 3 Way Valve System To Manual Shut Off) - A, AO, & AR (SN: 584000 & up), B (SN:201000 & up), D, G, H AI (Must adapt to your fuel line) (Can Also Use When Switching From Automatic Shut Off To Manual Shut Of) - 50 (up to SN:5016132), 60 (up to SN:6028468), 70 (All Diesel models and Gas models up to SN: 7006493), 520, 530, 620, 630, 720 Diesel, 730 Diesel, 4030 gas (Using 2.315 Long Glass Bowl), 4230 gas (Using 2.315 Long Glass Bowl)</p>	

Parts for Sediment Bowl Above

B9038-024	Connector w/ Female Fitting	\$8.99
B9038-008	2" Sediment Bowl Screen	\$3.99
B9038-012	Sediment Bowl Gasket	\$2.99

B9036-006	Sediment Bowl for CAV Fuel Filter	\$4.99
	<p>.71" Inner Diameter Bottom Hole, 1.6" Tall, 3.66" Outer Diameter, 3.31" Inner Diameter, Rounded bottom</p> <p>John Deere Replaces: #R56434, T19119, T25819 Fits: 820 (3-cylinder), 1020, 1120, 1520, 2020, 2030, 2130 (see additional fits on www.brillman.com)</p>	

JOHN DEERE LAWN & GARDEN

SPARK PLUG WIRE SETS

Our Spark Plug Wire Sets Come Fully Assembled with the Proper Type Wire & Terminals.

They are Custom Tailored to Look & Fit Like Original Factory Equipment.

Varieties include:

PVC Wire: Copper Core with a Rubber Jacket.

EPDM Wire (E): Hi Performance Premium Conductor with a Tinned Copper Core, EPDM Silicone Insulation, and a Rubber Jacket.



John Deere 316 (Serial #420,001 & Up)

with Onan P218G Engine

1 Cyl. Tailored Spark Plug Wire Set

B1029-006	Original Type PVC Wire	\$7.25
B1029-006E	EPDM Wire	\$9.00

John Deere 420 with Onan P220G Engine

2 Cyl. Tailored Spark Plug Wire Set

B1029-005	Original Type PVC Wire	\$16.50
B1029-005E	EPDM Wire	\$20.00

BATTERY CABLES



Our Battery Cables are made from the Proper Gauge Copper, as either Black Cotton Braided Wire or PVC Wire (whichever is correct for the application), using Soldered & Heat Sealed Brass or Copper Terminals.

John Deere 110, 112 (Up to Serial #130,000)

B2029-001	Negative Battery Cable	\$17.50
------------------	------------------------	----------------

John Deere 212

B2029-002	Positive Battery Cable	\$17.25
B2029-003	Negative Battery Cable	\$19.75

John Deere 317

B2029-004	Positive Battery Cable	\$25.75
------------------	------------------------	----------------

Replaces: #AM31404, AM36950

John Deere 110, 112 with Kohler K181

Replaces #HE167-001E, AM32072, AM35889

1 Cyl. Tailored Spark Plug Wire Set

B1029-001	Original Type PVC Wire	\$7.25
B1029-001E	EPDM Wire	\$9.00

John Deere 140, 214, 314 with Kohler K321

1 Cyl. Tailored Spark Plug Wire Set

B1029-003	Original Type PVC Wire	\$7.25
B1029-003E	EPDM Wire	\$9.00

WIRING HARNESSSES



Our Wire Harnesses are made with our premium cotton braid and/or PVC wire.

They have the correct gauge, color, wire, & fuse holders (if needed).

All terminals are soldered according to the original. (Harnesses do not include Battery Cables & Spark Plug Wires; however, we can supply these as separate products.) **NO HIDDEN COSTS, NOTHING EXTRA TO BUY!**

John Deere Lawn Tractor Model 110

Serial #3551 to #100,000

B3029-001	Complete Wire Harness	Replaces John Deere #AM30363 Main Harness, AM30271 Positive Battery Cable, AM30181 Switch-to-Starter Cable	\$115.25
------------------	-----------------------	--	-----------------

Serial #100,001 to 130,000

B3029-005	Main Harness	Replaces John Deere #AM31552, AM32174 Main Harness	\$103.00
------------------	--------------	--	-----------------

Serial #130,001 to #185,000

B3029-004	Main Harness	Replaces John Deere #AM32498 Main Harness	\$103.00
------------------	--------------	---	-----------------

John Deere Lawn Tractor Model 112

Up to Serial #100,000

B3029-001	Complete Wire Harness	Replaces John Deere #AM30363 Main Harness, AM30271 Positive Battery Cable, AM30181 Switch-to-Starter Cable	\$115.25
------------------	-----------------------	--	-----------------

Serial #100,001 to 130,000

B3029-005	Main Harness	Replaces John Deere #AM31552, AM32174 Main Harness	\$103.00
------------------	--------------	--	-----------------

Serial #130,001 to #161,771

B3029-004	Main Harness	Replaces John Deere #AM32498 Main Harness	\$103.00
------------------	--------------	---	-----------------

John Deere 140 (Serial #10,001-22,400)

B3029-003	Complete Wire Harness	Replaces John Deere #AM31964	\$129.75
------------------	-----------------------	------------------------------	-----------------

KOHLER

SPARK PLUG WIRE SETS

Kohler L600, L654 Light Plant

with thumbnut connection

4 Cyl. Tailored Spark Plug Wire Set

B1112-001	Original Type PVC Wire	\$23.00
B1112-001E	EPDM Wire	\$27.75

with push on connection; for use with Fairbanks-Morse Magneto #FMX-4B44A-3

4 Cyl. Tailored Spark Plug Wire Set

B1112-003	Original Type PVC Wire	\$23.00
B1112-003E	EPDM Wire	\$27.75
B1112-003S	Suppression Wire	\$27.75

Kohler K241



1 Cyl. Tailored Spark Plug Wire Set

B1112-002	Original Type PVC Wire	\$6.00
------------------	------------------------	---------------

TUNE UP PARTS

with Fairbanks-Morse Magneto #FMX-4B44A-3

	B4011-003 Points Replaces: #A2437A	\$18.50
	B4012-001 Condenser Replaces: #AXMR2433	\$11.00
	B4013-035 Cap Replaces: #W800	\$65.25
	B4014-018 Rotor Replaces: #DX2765	\$16.50
	B4015-002 Coil Replaces: #R2477C	\$39.75
	B4017-002 Rear Ball Bearing Replaces: #C5949	\$11.75
	B4017-039 Distributor Shaft Bearing Replaces: #D5950C	\$6.75

	B4016-002 Cap Gasket (Inner) Replaces: #H2498	\$2.75
	B4016-001 Cap Gasket (Outer) Replaces: #B682	\$2.75
	B4016-003 Complete Gasket Set Includes # H2498 (B4016-002), B682 (B4016-001), G2501, G3861, A2492A, Replaces: #GK17	\$14.75

with WICO Magnets #XH2485, B, C
(also fits XH2485D, except for the coil)

	B4011-004 Points Replaces: #1-5008, 1-5111, FXH-2100B, FXH-2400B, X5996	\$17.75
	B4012-002 Condenser Replaces: #2-5007, X5614, X6916	\$13.75
	B4013-025 Cap Replaces: #5-5030	\$69.50
	B4014-002 Rotor Replaces: #4-5010	\$23.50
	B4015-003 Coil (Hot Coil) Replaces: #5-5011, AR12006, FXH2403, X5700, X5700B, X5700C	\$39.75
	B9013-011 WICO Series X Nameplate Fits the WICO Series X magneto (<i>Rivets included</i>)	\$7.00
	B4017-007 Impulse Spring Replaces: #94-5016	\$12.50
	B4017-051 WICO Impulse Catch Plate Replaces: #94-5070, FXH-210S-1	\$10.25

LEADER

SPARK PLUG WIRE SETS

Leader D

4 Cyl. Tailored Spark Plug Wire Set





B1030-001	Original Type Cotton Braid Wire	\$20.25
B1030-001E	EPDM Wire	\$22.00

BATTERY CABLES



Leader D

B2000-004	Positive Ground Strap	\$10.50
B2030-001	Negative Battery Cable	\$28.00
B2030-002	Switch to Starter Cable	\$41.00

TUNE UP PARTS

Leader Tractors with Hercules #IXB5 Engine		
	B4001-002	\$14.75
	Points Replaces: #IGW-3028S, 1-31	
	B4002-005	\$9.75
	Condenser Replaces: #2-24, 2-35, 2-22, 2-23	
	B4004-004	\$11.50
	Rotor Premium Grade, Made in the USA Replaces: #4-15, IGB-1239	
	B4003-004	\$14.50
	Distributor Cap Premium Grade, Made in the USA (<i>Brass Contacts</i>) Replaces: #IGB-1241, IGB1241A, 3-21, 3-22	

IDENTIFICATION TAGS

	B9013-001	Small Autolite I.D. Tag (Blank)	\$7.00
		Small Autolite I.D. Tag (Stamped)	\$14.25
		2 5/16" Long, Black I.D. Tag for Distributors, Starters, & Generators with Rivets	
	B9013-002	Large Autolite I.D. Tag (Blank)	\$7.00
		Large Autolite I.D. Tag (Stamped)	\$14.25
		2 15/16" Long, Black I.D. Tag for Distributors, Starters, & Generators with Rivets	

ALTERNATORS

B6001-001	12 Volt Alternator (1 Wire)	\$112.75
B6001-005	6 Volt Alternator (1 Wire, Positive Ground)	\$166.50
B6002-003	12 Volt Small Denso Alternator (1 Wire)	\$119.75

LEYLAND

SPARK PLUG WIRE SETS

Our Spark Plug Wire Sets Come Fully Assembled with the Proper Type Wire & Terminals.

They are Custom Tailored to Look & Fit Like Original Factory Equipment.

Varieties include:

Cotton Braid Wire: Copper Core with a Cotton Jacket.

PVC Wire: Copper Core with a Rubber Jacket.

EPDM Wire (E): Hi Performance Premium Conductor with a Tinned Copper Core, EPDM Silicone Insulation, and a Rubber Jacket.



Leyland 154

4 Cyl. Tailored Spark Plug Wire Set

B1031-001	Original Type PVC Wire	\$21.50
B1031-001E	EPDM Wire	\$26.00

ALTERNATORS

Delco 10SI Type

B6001-001	12 Volt Alternator (1 Wire)	\$112.75
	Specially Built For Tractors, Forklifts, & Other Low Engine Speed Applications. Will also work well with normal speed applications.	
	Low Cut In, 63 Amp, Negative Ground. Note: Will not allow the warning lamp to function.	

Small ND Type

B6002-003	12 Volt Small Denso Alternator (1-Wire)	\$119.75
	40 Amp, 1 Wire Internal Regulator. Will Start Charging with a Much Lower Engine Speed. Comes with a 4 1/2" Housing Diameter, 3/8 To 1/2" Belt width & a 2 1/2" Pulley Diameter. Excellent for Converting a 6 Volt System to 12 Volt. Negative Ground Only & is Self-Excited	

LINCOLN WELDER

SPARK PLUG WIRE SETS

Our Spark Plug Wire Sets Come Fully Assembled with the Proper Type Wire & Terminals.

They are Custom Tailored to Look & Fit Like Original Factory Equipment.

Varieties include:

Cotton Braid Wire: Copper Core with a Cotton Jacket.

PVC Wire: Copper Core with a Rubber Jacket.

EPDM Wire (E): Hi Performance Premium Conductor with a Tinned Copper Core, EPDM Silicone Insulation, and a Rubber Jacket.

Suppression Wire (S): for Electronic Ignition and is Spiral Wound, Ultra Low-Ohm, with EPDM Silicone Insulation and a Rubber Jacket.



Lincoln Welder Models SA200, SA250 with Continental F162/ F163 with Distributor 4 Cyl. Tailored Spark Plug Wire Set

B1013-008	Original Type with PVC Wire <small>Note: the F162 uses PVC for this application.</small>	\$21.50
B1013-008E	EPDM Wire	\$26.00
B1013-008S	Suppression Wire	\$26.00

Lincoln Welder Models SA200, SA250 Continental F162/ F163 with Magneto 4 Cyl. Tailored Spark Plug Wire Set

B1013-029	Original Type with EPDM Wire	\$30.25
------------------	-------------------------------------	----------------



Lincoln Welder Model SA400 Continental F226 with Magneto on Side of Motor 6 Cyl. Tailored Spark Plug Wire Set

B1013-033	Original Type with EPDM Wire	\$54.50
------------------	-------------------------------------	----------------

TUNE UP PARTS FOR DISTRIBUTOR IGNITION

Lincoln Welder

SA200, SA250 with Autolite IBT-4705 Distributor

	B4001-017 Points Replaces: #IBP-2040L, IBP-3028BS, 1-33, 1-47V, 1-48	\$6.50
	B4002-006 Condenser Replaces: #2-31, 2-38, 2-42, 2-95, IAT-1125S, IAT-3076BS, IBB-2042SS-1, IBB-2042-SS3, IG-3927F, IG-3927G, IG-3927K, IG-3927R,	\$7.50

	B4004-040 Rotor Premium Grade, Made in the USA Replaces: #IAU-1016C, 4-23	\$6.25
	B4003-005 Distributor Cap Premium Grade, Made in the USA (Brass Contacts) Replaces: #IBT-1003B, IBT-1003C, 3-133, 3-123	\$18.25
	B4006-007 Dust Cover Replaces: #31-267, IBT-1059B	\$16.75



*For 12-Volt Ignition Coils & Accessories, see p.44







Lincoln Welder with Continental F266 Engine, Autolite/Prestolite Distributor #IBT-6701-A

	B4001-017 Points Replaces: #IBP-2040L, IBP-3028BS, 1-33, 147V, 1-48	\$6.50
	B4002-006 Condenser Replaces: #2-31, 2-38, 2-42, 2-95, IAT-1125S, IAT-3076BS, IBB-2042SS-1, IBB-2042-SS3, IG-3927F, IG-3927G, IG-3927K, IG-3927R,	\$7.50
	B4004-012 Rotor Premium Grade, Made in the USA Replaces: #4-86, 4-93	\$7.25
	B4003-065 Distributor Cap Replaces: #3-127, IBT-1112, IBT-1112B, IBT-11128	\$34.75

TUNE-UP PARTS FOR MAGNETO IGNITION

Lincoln Welder Models SA200, SA250 with Continental F162 & F163 Motors with Fairbanks-Morse Magneto (#FMX4B16A-1)

	B4011-003 Points Replaces: #A2437A	\$18.50
	B4012-001 Condenser Replaces: #AXMR2433	\$11.00
	B4013-001 Cap Replaces: #C800	\$49.75

	B4014-001 Rotor Replaces: #M2765	\$10.50
	B4013-003 Cap (Inner) Replaces: #AZ2430C	\$38.75
	B4015-002 Coil Replaces: #R2477C	\$39.75
	B4016-001 Cap Gasket (Outer) Replaces: #B682	\$2.75
	B4016-002 Cap Gasket (Inner) Replaces: #H2498	\$2.75
	B4016-003 Complete Gasket Set Includes # H2498 (B4016-002), B682 (B4016-001), G2501, G3861, A2492A, Replaces: #GK17	\$14.75
	B4016-005 Flange Gasket Replaces: #SAE	\$1.75
	B4017-001 Coil Lead Replaces: #FMJL	\$2.75
	B4014-009 Rotor Gear Replaces: #Y5939	\$29.75
	B4017-035 Rotor Gear (timing gear) Replaces: #Q5952	\$29.75
	B4017-002 Rear Ball Bearing Replaces: #C5949	\$11.75
	B4017-041 Coupling Impulse Spring Replaces: #D2565	\$16.00
	B4017-050 High Tension Rod Replaces: A983A	\$12.75

Lincoln Welder Models SA200, SA250 with Continental F162, & F163 Motors with Fairbanks-Morse Magneto (#FMP4B16A-1)		
	B4011-019 *Call for Availability* Points Replaces: #Q2437A	\$48.75
	B4012-001 Condenser Replaces: #AXMR2433	\$11.00
	B4013-001 Cap Replaces: #C800	\$49.75
	B4014-001 Rotor Replaces: #M2765	\$10.50
	B4013-003 Cap (Inner) Replaces: #AZ2430C	\$38.75
	B4015-002 Coil Replaces: #R2477C	\$39.75
	B4016-001 Cap Gasket (Outer) Replaces: #B682	\$2.75
	B4016-002 Cap Gasket (Inner) Replaces: #H2498	\$2.75
	B4016-003 Complete Gasket Set Includes # H2498 (B4016-002), B682 (B4016-001), G2501, G3861, A2492A, Replaces: #GK17	\$14.75
	B4016-005 Flange Gasket Replaces: #SAE	\$1.75
	B4017-001 Coil Lead Replaces: #FMJL	\$2.75

	B4014-009 Rotor Gear Replaces: #Y5939	\$29.75
	B4017-035 Rotor Gear (timing gear) Replaces: #Q5952	\$29.75
	B4017-002 Rear Ball Bearing Replaces: #C5949	\$11.75
	B4017-041 Coupling Impulse Spring Replaces: #D2565	\$16.00
	B4017-050 High Tension Rod Replaces: A983A	\$12.75

CARBURETOR REBUILD KITS

B9022-023	Marvel Schebler Carburetor Rebuild Kit	\$24.50
	Lincoln Welder - Models SA200, SA250 (With Continental F162, & F163 Motors)	

CARBURETOR FLOATS

B9023-003	Marvel-Schebler Carburetor Float	\$12.75
	Lincoln Welder - Models SA200, SA250 (With Continental F162, & F163 Motors) Fits Carburetor: Marvel-Schebler Carburetor: #TSX27A, TSX-28, TSX-34, TSX-55, TSX-88, TSX-155, TSX-188, TSX228, TSX-248, TSX-272, TSX-308, TSX-309, TSX-312, TSX-361, TSX-361A, TSX-458, TSX-514, TSX-541, TSX-605, TSX-683, TSX-882, TSXU-831, TSXU-832, TSXU-834 Marvel Schebler: #30-600	

REPLACEMENT MAGNETOS

Rebuilt Magnetos



Our Rebuilt Magnetos are completely torn down, cleaned, & inspected. They will (at the minimum) have the following new parts: Points, Condenser, Coil, Coil Insulators, Lead-out Tower, & Outside Covers, plus any additional parts that are needed to make the unit look & perform like new.

They come with a 1-Year Limited Warranty.

Notes:

1. Unless otherwise specified, cost is exchange price.
2. A core charge (see below) will be charged to your credit card until we receive your good core.
3. A good core is considered a complete magneto with no cracks or weld repairs. Only good cores will be credited.

*Magnetos must be used with copper ignition wire.
Use of any other type will Void the Warranty.*

XH1648R	Exchange	\$475.00
	Outright	\$675.00
	Rebuilt WICO Magneto 4 Cyl. Flange Mount Fits: Lincoln Welder - Models SA200, SA250 (With Continental F162, & F163 Motors) Replaces: Fairbanks-Morse Magneto - #FMX4B16A-1 Core Charge: \$200.00	
FMX4B16A1R	Exchange	\$475.00
	Outright	\$750.00
	Rebuilt Original Fairbanks Morse FMX4B16A-1 Magneto 4 Cyl. Flange Mount Fits: Lincoln Welder - Models SA200, SA250 (With Continental F162, & F163 Motors) Core Charge: \$275.00	

LONG

SPARK PLUG WIRE SETS

Long A with Continental F162 Engine

4 Cyl. Tailored Spark Plug Wire Set

B1032-001	Original Type Cotton Braid Wire	\$22.75
B1032-001E	EPDM Wire	\$24.50
B1032-001S	Suppression Wire	\$24.50
B1032-001CS	Cotton Suppression Wire	\$39.00

BATTERY CABLES

Long A

B2032-001	Positive Battery Cable	\$28.00
B2032-002	Negative Battery Cable	\$38.25

TUNE UP PARTS

Long A (Battery Ignition)

	B4001-005	\$9.75
	Points Replaces: #1-4, 1-8, 1-9, 1-20, 1-22, 1-45, IAD-3128S, IGP-3028ES, IGP3028FS, IGS2224L, IGW3028AS	
	B4002-006	\$7.50
	Condenser Replaces: #2-31, 2-38, 2-42, 2-95, IAT-1125S, IAT-3076BS, IBB-2042SS-1, IBB-2042-SS3, IG-3927F, IG-3927G, IG-3927K, IG-3927R,	
	B4004-003	\$5.25
	Rotor Premium Grade, Made in USA Replaces: #4-10	
	B4003-003	\$21.00
	Distributor Cap Made in the USA (Brass Contacts) Replaces: #IG-1324D, 3-11, 3-12	

ELECTRONIC IGNITION CONVERSION KITS

Replaces Points & Condenser



Long A

B9600-057	12 Volt Negative Ground	\$129.95
B9600-057P12	12 Volt Positive Ground	\$147.45
B9600-057N6	6 Volt Negative Ground	\$147.45
B9600-057P6	6 Volt Positive Ground	\$147.45



***For Ignition Coils & Accessories, see p.44**

IDENTIFICATION TAGS

B9013-001	Small Autolite I.D. Tag (Blank)	\$7.00
	Small Autolite I.D. Tag (Stamped)	\$14.25
	2 5/16" Long, Black I.D. Tag for Distributors, Starters, & Generators with Rivets	
B9013-002	Large Autolite I.D. Tag (Blank)	\$7.00
	Large Autolite I.D. Tag (Stamped)	\$14.25
	2 15/16" Long, Black I.D. Tag for Distributors, Starters, & Generators with Rivets	



ALTERNATORS

B6001-001	12 Volt Alternator (1 Wire)	\$112.75
B6001-002	12 Volt Alternator (1 Wire/ 3 Wire)	\$118.75
B6002-003	12 Volt Small Denso Alternator (1 Wire)	\$119.75

STARTER SWITCHES

(MECHANICAL)

B5006-001	Starter Switch (Long Shaft)	\$12.75
	6 or 12 Volt Panel Mounted Manual Push Start Switch Replaces: Delco - #192119, D900, 450C Prestolite - #15-121, 15-122, 15-409, 15-45, 15-47, 15-50, 15-51, SW-2916, SW-4001, SW-4002, SW-4005, SW-4010, SW-4013, SW-4015, SW-4017, SW-4101, SWX-47 Fits: Long - Used With Starter #MZ-4118, MZ-4175, MZ-4184	

MASSEY FERGUSON

TABLE OF CONTENTS

Spark Plug Wire Sets	311
Battery Cables	312
Wire Harnesses	313
Tune Up Parts	314
Distributors	315
Electronic Ignition Conversion Kits	316
Switches	316
Voltage Regulators	318
Generator Repair Kits & Brush Sets	318
Identification Tags	319
Alternators	319
Alternator Brackets	319
Alternator Conversion Kits	319
Lights & Light Parts	319
Gauges	321
Tachometer Drives	322
Auxiliary Plugs & Sockets	322
Cigarette Lighters	322
Starters	322
Starter Switches & Solenoids	322
Carburetor Rebuild Kits	323
Carburetor Floats	324
Fuel Sediment Bowls	325
Carburetor/ Fuel System Accessories	325

Massey Ferguson TO-30, TO-35, 35, 40,

50, 135 with Continental Z134 Engine
4 Cyl. Tailored Spark Plug Wire Set

B1033-002	Original Type PVC Wire	\$20.00
B1033-002E	EPDM Wire	\$24.00
B1033-002S	Suppression wire	\$24.00

Massey Ferguson 65, 165

with Continental G176 Engine
4 Cyl. Tailored Spark Plug Wire Set

B1033-005	Original Type PVC Wire	\$20.00
B1033-005E	EPDM Wire	\$24.00
B1033-005S	Suppression wire	\$24.00

Massey Ferguson 85

with Continental E223 Engine
4 Cyl. Tailored Spark Plug Wire Set

B1033-006	Original Type PVC Wire	\$20.00
B1033-006E	EPDM Wire	\$24.00
B1033-006S	Suppression wire	\$24.00

Massey Ferguson 97

6 Cyl. Tailored Spark Plug Wire Set

B1033-007	Original Type PVC Wire	\$43.00
B1033-007E	EPDM Wire	\$51.00

Massey Ferguson 135, 150, 235

with Perkins AG3 Engine
3 Cyl. Tailored Spark Plug Wire Set

B1033-008	Original Type PVC Wire	\$20.00
B1033-008E	EPDM Wire	\$24.00
B1033-008S	Suppression wire	\$24.00

Massey Ferguson 135

4 Cyl., w/ Continental Engine (See # B1033-002 above)

Massey Ferguson 165

with Perkins AG4.212 Engine
3 Cyl. Tailored Spark Plug Wire Set

B1033-011	Original Type EPDM Wire	\$27.50
B1033-011S	Suppression wire	\$27.50

Massey Ferguson 165

4 Cyl., w/ Continental Engine (See # B1033-005 above)

Massey Ferguson 'Work Bull' 204

with Continental Z134 Engine
4 Cyl. Tailored Spark Plug Wire Set

B1033-002	Original Type PVC Wire	\$21.00
B1033-002E	EPDM Wire	\$25.25
B1033-002S	Suppression wire	\$25.25

Massey Ferguson 230

with Continental Z145 Engine
4 Cyl. Tailored Spark Plug Wire Set

B1033-009	Original Type PVC Wire	\$20.00
B1033-009E	EPDM Wire	\$24.00
B1033-009S	Suppression wire	\$24.00

SPARK PLUG WIRE SETS

Our Spark Plug Wire Sets Come Fully Assembled with the Proper Type Wire & Terminals.

They are Custom Tailored to Look & Fit Like Original Factory Equipment.

Varieties include:

PVC Wire: Copper Core with a Rubber Jacket.

EPDM Wire (E): Hi Performance Premium Conductor with a Tinned Copper Core, EPDM Silicone Insulation, and a Rubber Jacket.

Suppression Wire (S): for Electronic Ignition and is Spiral Wound, Ultra Low-Ohm, with EPDM Silicone Insulation and a Rubber Jacket.



Massey Ferguson TO-20

with Continental Z120 Engine
4 Cyl. Tailored Spark Plug Wire Set

B1033-001	Original Type PVC Wire	\$20.00
B1033-001E	EPDM Wire	\$24.00
B1033-001S	Suppression wire	\$24.00

BATTERY CABLES



Our Battery Cables are made from the Proper Gauge Copper, as either **Black Cotton Braided Wire** or **PVC Wire** (whichever is correct for the application), using Soldered & Heat Sealed Brass or Copper Terminals.

Massey Ferguson TE-20

B2033-001	Positive Battery Cable	\$32.25
B2000-004	Negative Ground Strap	\$10.50
B2033-002	Switch to Starter Cable	\$27.50

Massey Ferguson TO-20

B2033-003	Positive Battery Cable	\$32.25
B2000-004	Negative Ground Strap	\$10.50
B2033-004	Switch to Starter Cable	\$27.50

Massey Ferguson TO-30

B2033-005	Positive Battery Cable	\$32.25
B2000-002	Negative Ground Strap	\$9.50
B2033-004	Switch to Starter Cable	\$27.50

Massey Ferguson TO-35

B2033-006	Negative Battery Cable	\$29.75
B2000-007	Positive Ground Strap	\$14.50
B2033-059	Switch to Starter Cable	\$23.50

Massey Ferguson 35 Gas

B2033-009	Positive Battery Cable	\$28.50
B2000-007	Negative Ground Strap	\$14.50
B2033-010	Switch to Starter Cable	\$21.75

Massey Ferguson 35 Diesel

B2033-011	Positive Battery Cable	\$31.75
B2033-012	Negative Battery Cable	\$31.75

Massey Ferguson 40

B2033-013	Positive Battery Cable	\$26.50
B2000-010	Negative Ground Strap	\$21.75
B2033-015	Switch to Starter Cable	\$20.50

Massey Ferguson 50 Gas & LP

B2033-016	Positive Battery Cable	\$26.50
B2000-010	Negative Ground Strap	\$21.75
B2033-019	Switch to Starter Cable	\$20.50

Massey Ferguson 65 Gas

B2033-022	Positive Battery Cable	\$26.50
B2000-010	Negative Ground Strap	\$21.75
B2033-024	Switch to Starter Cable	\$20.50

Massey Ferguson 65 LP

B2033-025	Positive Battery Cable	\$26.50
B2000-010	Negative Ground Strap	\$21.75
B2033-027	Switch to Starter Cable	\$20.50

Massey Ferguson 65 Diesel

B2033-028	Positive Battery Cable	\$44.00
B2033-029	Negative Battery Cable	\$44.00

Massey Ferguson 85 Gas

B2033-030	Positive Battery Cable	\$31.75
B2000-009	Negative Battery Cable	\$9.75

Massey Ferguson 85 Diesel

B2033-032	Positive Battery Cable	\$50.75
B2000-007	Negative Ground Strap	\$14.50

Massey Ferguson 88 Gas

B2033-034	Positive Battery Cable	\$28.50
B2033-035	Negative Battery Cable	\$28.50

Massey Ferguson 88 Diesel

B2033-036	Positive Battery Cable	\$50.75
B2000-007	Negative Ground Strap	\$14.50

Massey Ferguson 90 Gas

B2033-039	Positive Battery Cable	\$31.75
B2033-040	Negative Battery Cable	\$28.50
B2033-041	Switch to Starter Cable	\$25.75

Massey Ferguson 90 Diesel

B2033-042	Positive Battery Cable	\$39.25
------------------	------------------------	----------------

Massey Ferguson 98 Diesel

B2033-043	Positive Battery Cable	\$34.75
B2033-044	Negative Battery Cable	\$44.00

Massey Ferguson 135 Gas

B2033-045	Positive Battery Cable	\$31.75
B2033-046	Negative Battery Cable	\$28.50

Massey Ferguson 135 Diesel

B2033-047	Positive Battery Cable	\$39.25
B2033-048	Negative Battery Cable	\$44.00

Massey Ferguson 150

B2033-049	Positive Battery Cable	\$35.00
B2033-050	Negative Battery Cable	\$26.50

Massey Ferguson 165 Gas

B2033-051	Positive Battery Cable	\$31.75
B2033-052	Negative Battery Cable	\$26.50

Massey Ferguson 175 Diesel

B2033-055	Positive Battery Cable	\$44.00
B2033-056	Negative Battery Cable	\$34.75

Massey Ferguson 165 Diesel

B2033-053	Positive Battery Cable	\$50.75
B2033-054	Negative Battery Cable	\$32.00

Massey Ferguson 180 Diesel

B2033-057	Positive Battery Cable	\$50.75
B2033-058	Negative Battery Cable	\$25.25



WIRING HARNESSSES

Our Wire Harnesses are made with our **premium cotton braid and/or PVC wire**.

They have the **correct gauge, color, wire, & fuse holders** (if needed).

All terminals are **soldered according to the original**.

(Harnesses do not include Battery Cables & Spark Plug Wires; however, we can supply these as separate products.)

NO HIDDEN COSTS, NOTHING EXTRA TO BUY!

Massey Ferguson TO-20

B3033-001	Complete Wire Harness		\$213.25
B3033-015	Complete Wire Harness Modified for Delco 10SI Alternator		\$213.25
B3033-016	Basic (Main) Harness Modified for Delco 10SI Alternator	*Charge Indicator Light Will Function with this Harness*	\$67.00

Massey Ferguson TO-30

B3033-002	Complete Wire Harness		\$193.75
B3033-010	Complete Wire Harness Modified for Delco 10SI Alternator		\$193.75

Massey Ferguson TO-35

B3033-003	Complete Wire Harness		\$193.75
B3033-005	Complete Wire Harness Modified for 1 Wire Alternator		\$193.75
B3033-006	Complete Wire Harness Modified for Delco 10SI Alternator		\$193.75

Massey Ferguson 35 Gas

B3033-014	Complete Wire Harness		\$193.75
B3033-017	Complete Wire Harness Modified for 1 Wire Alternator		\$193.75

Massey Ferguson 40 Gas & LP

B3033-004	Complete Wire Harness		\$193.75
B3033-013	Complete Wire Harness Modified for 1 Wire Alternator		\$193.75
B3033-019	Complete Wire Harness Modified for Delco 10SI Alternator		\$193.75

Massey Ferguson 50 Gas & LP

B3033-004	Complete Wire Harness		\$193.75
B3033-013	Complete Wire Harness Modified for 1 Wire Alternator		\$193.75
B3033-019	Complete Wire Harness Modified for Delco 10SI Alternator		\$193.75

Massey Ferguson 50 Diesel

B3033-012	Complete Wire Harness Early with Generator & Voltage Regulator		\$193.75
B3033-018	Complete Wire Harness Modified for 1 Wire Alternator		\$193.75

Massey Ferguson 65 Gas & LP

B3033-004	Complete Wire Harness		\$193.75
B3033-013	Complete Wire Harness Modified for 1 Wire Alternator		\$193.75
B3033-019	Complete Wire Harness Modified for Delco 10SI Alternator		\$193.75

Massey Ferguson 165 Gas

B3033-011	(Main Only) Wire Harness		\$75.25
------------------	---------------------------------	--	----------------

Note



When ordering, please specify **Year** or **Serial Number**, Magneto/Distributor, & Regulator/Cut Out Relay.
Some Harnesses were originally made with PVC Wire & Braided; others were made with PVC Wire & Taped.
In those cases, we build them the **Original Way**.

TUNE UP PARTS

Massey Ferguson (4 Cyl)

35, 50, 65, 85, 88, 90, 202, 204 TO-20, TO-30, TO-35 with Clip On Distributor Cap & also with Distributor #1111740

	B4100-001	\$10.50
	PCR Kit Includes: Points (#B4001-001), Condenser (#B4002-001), Rotor (#B4004-002) Replaces: Points - #D100HP, 1855720 Condenser - #1928111, D-203, 1869704, D-200 Rotor - #820445, D400	
	B4004-002	\$5.75
	Rotor Replaces: #820445, D400	
	B4003-001	\$13.50
	Distributor Cap Premium Grade, Made in the USA (Brass Contacts) Replaces: #811735, D300	
	B4006-001	\$9.99
	Dust Cover Replaces: #1900119	
	B4007-001	\$11.95
	Cap Clip Short Mount, 1 Used Replaces: #1889967, 1847289, 453844, 453461	
	B4007-002	\$11.95
	Cap Clip Long Mount, 1 Used Replaces: #1889967, 1889999, 453844, 453461	

	B4008-001	\$14.99
	Distributor Insulator Replaces: #1904376	
	B4009-001	\$25.99
	Distributor Bushing & Shim Kit	

*For 6- or 12-Volt Ignition Coils & Accessories, see p.44

Massey Ferguson (4 Cyl)

20, 30, 35, 40, 50, 65, 135, 150, 165, 175, 180, 181, 202, 204, 235, 255, 265, 285, 302, 304, 356, 2135, 2200, 2500, 3165, Delco Distributor #1112458, 1112643, 1112644 with Screw On Distributor Cap

	B4100-003	\$9.75
	PCR Kit Includes: Points (#B4001-012), Condenser (#B4002-012), Rotor (#B4004-013) Replaces: Points - #D108P Condenser - #D205 Rotor - #D-419R, 1963972	
	B4004-013	\$4.75
	Rotor Premium Grade, Made in the USA Replaces: #D-419R, 1963972	
	B4003-015	\$16.25
	Distributor Cap Brass Contacts Replaces: #D-322	
	B4006-004	\$16.99
	Dust Cover Replaces: #1960325	

*For 12-Volt Ignition Coils & Accessories, see p.44

Massey Ferguson (4 Cyl) 245 with Autolite IBT-4406 Distributor		
	B4001-017	\$6.50
	Points Replaces: #IBP-2040L, IBP-3028BS, 1-33, 1-47V, 1-48	
B4002-002		\$4.75
	Condenser #2-23, 2-31, 2-32, 2-34, 2-38, 2-42, IAT-2015L, IAT-2015R, IAT-3076AS, IAT-3076BS, IAT-3076D, IAT-3076DS, IAT-3076L, IAT-3076LA, IAT-3076R, IAT-3076RA, IBB-2015L, IBB-2015R, IBB-2042-SS, IBB-2042SS-1, IBB-2042-SS3, IG-2671F, IGH-3076, IGW-3139, 2098058, 3420600	
	B4004-005	\$7.25
	Rotor Premium Grade, Made in the USA Replaces: #IBT-1016, IAU-1104, 4-26, 4-28	
	B4003-005	\$18.25
	Distributor Cap Premium Grade, Made in the USA (Brass Contacts) Replaces: #IBT-1003B, IBT-1003C, 3-133, 3-123	
	B4006-007	\$16.75
	Dust Cover Replaces: #31-267, IBT-1059B	

*For 12-Volt Ignition Coils & Accessories, see p.44

Massey Ferguson (4 Cyl) 35, 50, 65, 85, 88, 90, 202, 204 TO-20, TO-30, TO-35 with Replacement Autolite/Prestolite Distributor		
	B4001-005	\$9.75
	Points Replaces: #1-4, 1-8, 1-9, 1-20, 1-22, 1-45, IAD-3128S, IGP-3028ES, IGP3028FS, IGS2224L, IGW3028AS	
B4002-002		\$4.75
	Condenser Replaces: #2-23, 2-31, 2-32, 2-34, 2-38, 2-42, IAT-2015L, IAT-2015R, IAT-3076AS, IAT-3076BS, IAT-3076D, IAT-3076DS, IAT-3076L, IAT-3076LA, IAT-3076R, IAT-3076RA, IBB-2015L, IBB-2015R, IBB-2042-SS, IBB-2042SS-1, IBB-2042-SS3, IG-2671F, IGH-3076, IGW-3139, 2098058, 3420600	
	B4004-012	\$7.25
	Rotor Premium Grade, Made in the USA Replaces: #4-86, 4-93	

	B4003-012	\$15.00
	Distributor Cap Made in the USA (Brass Contacts) Replaces: #3-129, IBK-1009	

*For 6- or 12-Volt Ignition Coils & Accessories, see p.44

Massey Ferguson (3 Cyl, Perkins) 20, 40, 135, 150, 2200, 2500, Delco Distributor #1112457 with Screw On Distributor Cap		
	B4100-003	\$9.75
	PCR Kit Includes: Points (#B4001-012), Condenser (#B4002-012), Rotor (#B4004-013) Replaces: Points - #D108P Condenser - #D205 Rotor - #D-419R, 1963972	
	B4004-013	\$4.75
	Rotor Premium Grade, Made in the USA Replaces: #D-419R, 1963972	
	B4003-058	\$15.75
	Distributor Cap Replaces: #1035263MI	
B4006-004	Dust Cover	Replaces: #1960325 \$16.99

*For 12-Volt Ignition Coils & Accessories, see p.44

Massey Ferguson (4 Cyl., Lucas) Ferguson TEA20, FE35, Massey Ferguson 135UK		
	B4100-011	\$18.75
	PCR Kit Includes: Points, Condenser, Rotor	

DISTRIBUTORS

181685M91	Delco Remy Distributor	\$129.75
	4 Cyl. New Replacement Distributor Replaces: Massey Ferguson - #181685M91, 182852M91, 181544M91, 181686M91 Delco - #1111722, 1111740, 1112557, 1112570 Fits: Massey Ferguson - 35, 50, F40, TO-20, TO-30, TO-35	

B9500-017	4-Cylinder Pertronix Distributor	\$279.95
12-Volt, Negative Ground, Counter-Clockwise Rotation Replaces: Prestolite - IDU-4406, IDU-4408 Fits: Perkins 1992 & prior with G4236 engine Note: Must use Suppression Spark Plug Wire.		

ELECTRONIC IGNITION CONVERSION KITS

Replaces Points & Condenser



Massey Ferguson 88, 90, 202, 204 with Delco Distributor & Clip On Cap & Clockwise Rotation		
B9600-006	12 Volt Negative Ground	\$147.45
B9600-006P12	12 Volt Positive Ground	\$165.45
B9600-006P6	6 Volt Positive Ground	\$165.45

Massey Ferguson TO-20, TO-30, TO-35, F-40, 35, 50, MH-50, 65, 85, 135 with Delco Distributor #1111722, 1111740, 1112557, 1112570, 1112583, 1112589, 1112591 & Clip On Cap & Counter-Clockwise rotation		
B9600-007	12 Volt Negative Ground	\$154.95
B9600-007P12	12 Volt Positive Ground	\$169.45
B9600-007P6	6 Volt Positive Ground	\$169.45

Massey Ferguson 4 Cyl. 20, 30, 35, 40, 50, 65 135, 150, 165, 175, 180, 181, 202, 204, 235, 255 265, 285, 302, 304, 356, 21353, 2200, 2500, 3165 with Delco Distributor #1112458, 1112643, 1112644 & Screw On Distributor Cap		
B9600-009A	12 Volt Negative Ground	\$124.95
B9600-009AP12	12 Volt Positive Ground	\$139.95

Massey Ferguson 4 Cyl. 202 Industrial, 230 with Continental Z145, 245 with Autolite/Prestolite Distributor #IBT-4406		
B9600-060	12 Volt Negative Ground	\$179.95

Massey Ferguson 4 Cyl. TEA20 with Lucas Distributor		
B9600-144	12 Volt Negative Ground	\$177.45
B9600-144P12	12 Volt Positive Ground	\$191.45

Massey Ferguson 3 Cyl. 135 with Perkins Engine & Delco Distributor #1112457		
B9600-004	12 Volt Negative Ground	\$205.95



Massey Ferguson 4 Cyl. MF-36 with Delco Distributor #1112448, 1112478		
B9600-010A	12 Volt Negative Ground	\$124.95



***For Ignition Coils &
Accessories, see p.44**

STARTER SWITCHES & SOLENOIDS

Push/Pull Switches

B5002-001	2 Position Push/Pull Switch	\$7.75
	OFF/ON Universal 2 Position Push/Pull (2 Screw Terminals) Mounting Stem 3/8"-32 Thread Knob #10/32 Thread	
B5002-004	Heavy Duty Push/Pull Magneto Switch	\$8.25
	ON/OFF (2 Position) Push/Pull Magneto Switch (2 Screw Terminals) Mounting Stem 3/8"-32 Thread Knob #10/32 Thread	

Key Switches

B5003-001	2 Position Battery Key Switch	\$14.75
	Universal OFF/ON 2 Position Key Switch (For Battery Ignition) (2 Screw Terminals) Mounting Stem 3/4"-20 Thread	
B5003-004	4 Position Battery Key Switch	\$22.99
	OFF/IGN/IGN Lights/Lights (4 Position) Key Switch (3 Screw Terminals) Mounting Stem 5/8"-32 Thread Massey Ferguson Replaces: #180681M93 Fits: 35, 40, 50 (Gas up to SN: 528970), 65, 85, 88, 202, 204, TO- 20, TO-30, TO-35	
B5003-008	Ignition Key Switch	\$24.99
	Includes 2 Keys, 2 Spade Terminals, Designed for 0.800" hole diameter. Massey Ferguson Fits: TE-20, TO-20, TO-35, TO-30, 35, 40, 50, 65	

B5003-017	4 Position Ignition Key Switch	\$16.99
	<p>This is a Replacement 4 Position Switch. Has a Total of 6 Spade Terminals. 2 of the Terminals are .375" Wide and the other 4 Terminals are .250" Wide. The threaded end is .625"</p> <p>Massey Ferguson Replaces: Delco - #1533514</p> <p>Massey Ferguson - #1690093M91, 1874120M91, 1874120M93, 1874120T93, 1874535M1, 1874535M3</p>	

B5003-021	Ignition Key Switch	\$34.00
	<p>Includes 2 Keys, 3 Spade Terminals <i>Designed for 0.625" hole diameter.</i></p> <p>Massey Ferguson Replaces: #194747M91 Fits: 135, 150, 165, 175, 180, 230, 235, 245, 255, 265, 1100, 1130, 1500, 1800; Ind: 20, 20C, 30, 30B, 40, 2135, 2200, 3165</p>	

Momentary Switches

B5004-003	Momentary Push Switch	\$15.75
	<p>Manual Push Button Solenoid Switch with Rubber Protected Cap (2 Screw Terminals) Mounting Stem 5/8"-32 Thread</p> <p>Massey Ferguson Replaces: #189158M91, 189158M1 Fits (all w/Starter or Ether Switch)</p> <p>MF 4WD: 1500, 1505, 1800, 1805, 4800, 4840 MF Combine: 540, 550, 750, 760, 850, 855, 865, 8570 MF Industrial: 20C, 30, 30B, 31, 40, 40B, 50A, 50C, 60, 80, 202, 204, 302, 304, 356 MF Tractor: 35, 40, 50, 65, 85, 88, 265, 670, 690, 698, 699, 1080, 1085, 1100, 1105, 1130, 1135, 1150, 1155, 2640, 2675, 2705, 2745, 2775, 2805, 3505, 3525, 3545, Super 90, TO-35</p>	

B5004-008	Neutral Safety Switch	\$15.49
	<p>Massey Ferguson Replaces: 181140M1, 181140M91, 181140M92, 181140M93, 181140M94, 181140V94 Fits: 20, 20C, 30, 30B, 30D, 31, 35, 40, 40B, 50, 50A, 50C, 50D, 60, 65, 85, 88, 135, 150, 165, 175, 180, 202, 203, 204, 230, 235, 245, 255, 265, 275, 283, 285, 1080, 1085, 1100, 1130, 6500, Super 90, TO-35</p>	

B5004-009	Neutral Safety Switch Boot	\$11.99
	<p>Fits 1.000" Dia. Switch, 1.125" Deep, 0.140" Wire hole diameter.</p> <p>Massey Ferguson Replaces: #180776M1 Fits: 20, 20C, 30, 30B 30D, 31, 35, 40, 40, 40B, 50, 50A, 50C, 50D, 60, 65, 85, 88, 135, 150, 165, 175, 180, 202, 203, 204, 230, 235, 245, 255, 265, 275, 285, 302, 304, 1080, 1085, 2135, 2200, 2500, 3165, 4500, 6500, FE35, Super 90, TO-35</p>	

Solenoids

B5007-004	12 Volt Solenoid	\$23.75
	<p>Has a Curved Bracket & 4 Terminals (Used with 30 & 35 MT Delco Starters) Fits: Massey Ferguson - 85, 88, 275, 285, 1080, 1085, 1100, 1105, 1130, 1135, 2675, 2705, Super 90 (Diesel)] Replaces: Delco - #1119890, 1119912, 1119885, 1119877, 1119935, 1119882, 1119906, D953, D985, 1119833, 1119883, 1115537, 1119978, 1115582, 1119778, 1115508, 1115529, 1115540, 1115501 Massey Ferguson - #1009784M91, 1028587M91, 1017877M92</p>	

B5007-014	12 Volt Solenoid for Lucas M50 Starters	\$33.50
	<p>12 Volt Rated Solenoid with 4 Terminals and Mounted to Lucas M50 Direct Drive Starters. Replaces: Lucas - #77004, 77089, TOB175 Massey Ferguson - #1052442M91, 3473296M91 Fits: Massey Ferguson - 2640, 2675, 2705, 3090, 3505, 3525, 3545, 3630, 3650</p>	

B5007-015	12 Volt Solenoid for Lucas M50 Starters	\$34.25
	<p>12 Volt Rated Solenoid with 4 Terminals and Mounted to Lucas M50 Direct Drive Starters. Replaces: Lucas - #60933087, 76906, 76937, 77123, 77123A, TOB118, TPB100 Massey Ferguson - #1447-586-M91, 8972-69-M1</p>	

B5007-018	Lucas M50 12 Volt Starter Solenoid	\$40.75
	<p>12 Volt Rated Solenoid for Lucas M50 Direct Drive Starters. 4 Terminals. Replaces: Lucas - #27228A, 76740, 76753, 76756, 76781, 76825, 76833, 76834, 76835, 76836, 76854, 76862, 76864, 76865, 76869, 76881, 76900, 76905, 76910, 76911, 76912, 76913, 76928, 76956, 77010, 77014, 77025, 77032, 77052, 77109, TOB108, TOB110, TOB111, TOB114, TOB129, TOB133, TOB179, TOB184, TOB199 Massey Ferguson - #390119M1 Fits: Massey Ferguson - 20, 25, 31, 50, 60, 135, 148, 165, 168, 175, 180, 185, 188, 230, 240, 250, 255, 261, 265, 270, 271, 275, 281, 282, 283, 285, 290, 298, 350, 362, 365, 372, 374, 375, 382, 383, 390, 393, 396, 398, 399, 550, 565, 575, 590, 670, 690, 698, 699, 1080</p>	

B5007-043	12 Volt Solenoid for Lucas M50 Starters	\$34.00
 <p>12 Volt Rated Solenoid with 4 Terminals and Mounted to Lucas M50 Direct Drive Starters. Replaces: Massey Ferguson - #579-488-M91 Fits: Massey Ferguson - (1956-2003)</p>		

VOLTAGE REGULATORS

Note: Due to modern battery design, voltage regulators can't be used to charge low or dead batteries. Doing so will destroy the voltage regulator and void the warranty.

6-Volt Delco Type Voltage Regulator		
B8002-013	Premium Quality, USA Made	\$119.75
B8002-014	Standard Quality	\$34.75
 <p>6 Volt, Positive Ground, 4 Terminals, Flat Mounting Bracket Replaces: Delco - #1116807, 1116816, 1118291, 1118308, 1118780, 1118982, 1119575, D645, D657 Prestolite - #8-291, GRX-291 Fits: Massey Ferguson - (6 Volt, Tractor Mounted) MF40, MF202, MF204, MF302, MF304, MF356, TO-20, TO-30, TO-35</p>		

12-Volt Delco Type Voltage Regulator		
B8002-017	Premium Quality, Made in the USA	\$99.75
B8002-018	Standard Quality	\$34.75
 <p>12 Volt, 4 Terminals, Flat Mounting Bracket Regulator Tractor Mounted Fits: Massey Ferguson - (MF40, MF50, MF65, MF202, MF204, MF302, MF304, MF356, TO-35, With Generator #1100998) Replaces: Delco - #1118381, 1118779, 1118977, 1118987, 1118993, 1118997, 1118999, 1119576, D646 Prestolite - #8-290</p>		

12-Volt Delco Type Voltage Regulator		
B8002-015	Premium Quality, USA Made	\$108.50
B8002-016	Standard Quality	\$34.75
 <p>12 Volt, 4 Terminals, Curved Mounting Bracket/ Generator Mounted, Positive or Negative Ground Replaces: Delco - #1118266, 1118306, 1118791, 1118983, 1118985, D644, D648 Fits: Massey Ferguson - 303, 404, 1001, MJA-382, MJA-382D, MJD-382D (With Generator #110328), 404 (With Generator #GHH-6003A)</p>		

Did You Know?

Harry Massey held the patent for the three-point hitch design.

ALTERNATOR VOLTAGE REGULATORS

B8002-030	Alternator Voltage Regulator	\$14.50
 <p>Heavy Duty, 12 Volt, Negative Ground Alternator Voltage Regulator. Has 4 spade terminals (field, 2, 3, 4). Designed for 'B' type circuits in negative ground systems & 12 volt systems only. For Delco 10DN, & 20DN Replaces: Massey Ferguson - #1031060M91, 182548M1, 1903077M91, 1071060M91, 1032-976-M91, 1038-062-M91, 1903-077-M91, 1903-087-M91, 508-552-M91, 508-552-M92 Delco - #D630, D635, D663, 1119513, 1119515, 1119508, 1119519, D663, 1119502, 1119516, 1119506, 1119512, 1119515 Fits: Massey Ferguson - Fits: 70, [80, 1085, 1100, 1150, 1500, 1800 (Diesel)], 135, [150, 404 (Gas)], 165, 175, 180, 302, 304, 356, [1080, 1130, 1800, 2135, 2200, 2500 (With Factory Alternator)], 3165, MF Tractor: 20, 30, MF Industrial: 40, MF Tractor: 44 (Diesel), MF Industrial: 50, MF Tractor: 55, [70, 80 (With Factory Alternator)]</p>		

GENERATOR REPAIR KITS & BRUSH SETS

X360	6 Volt, 3 Brush Generator Set	\$6.25
 <p>Includes 3 Brushes, Tractor Mounted Massey Ferguson Fits: MF40, MF202, MF204, MF302, MF304, MF356, TO-30, TO-35</p>		
X348	12 Volt, 3 Brush Generator Set	\$6.00
 <p>Includes 3 Brushes Tractor Mounted Massey Ferguson Fits (With Generator #1100998): MF40, MF50, MF65, MF202, MF204, MF302, MF304, MF356, TO-35, MH50</p>		
X270	12 Volt, 2 Brush Generator Set	\$5.00
 <p>Includes 2 Brushes Generator Mounted Massey Ferguson Fits: 303, 404, 1001, MJA-382, MJA-382D, MJD-382D, With Generator #110328</p>		
X324	12 Volt, 3 Brush Generator Set	\$8.25
 <p>Includes 3 Brushes Generator Mounted Massey Ferguson Fits: 404, With Generator #GHH-6003A</p>		

IDENTIFICATION TAGS

B9013-004	Delco Remy I.D. Tag (Blank)	\$7.00
	Delco Remy I.D. Tag (Stamped)	\$14.25
		Black Delco-Remy I.D. Tag for Distributors, 6 Volt Starters, & 6 Volt Generators with Rivets, 3/4" 2 5/16"
B9013-005	Red Delco Remy I.D. Tag (Blank)	\$7.00
	Red Delco Remy I.D. Tag (Stamped)	\$14.25
		Red Delco-Remy I.D. Tag for 12 Volt Starters & 12 Volt Generators with Rivets, 3/4" 2 5/16"
B9013-013	Delco Remy I.D. Tag (Blank)	\$7.00
	Delco Remy I.D. Tag (Stamped)	\$14.25
		Black Delco-Remy I.D. Tag for Distributors, 6 Volt Starters, & 6 Volt Generators with Rivets, 3/4" 2 5/16"

Massey-Harris Ferguson

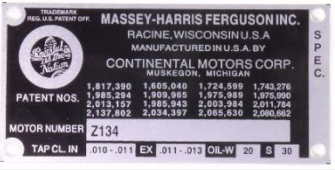
B9013-014	Blank Engine Serial Number Tag	\$32.99
		Massey-Harris Ferguson Serial Number Tag (Size 3 5/16" x 1 15/16") Massey Harris Fits: 50 Series, 40, TO-35, 50, 202, 204, 2135, 135, 35



ALTERNATORS

B6001-001	12 Volt Alternator (1 Wire)	\$112.75	
63 Amp, Low Cut In, Specially Built For Tractors, Forklifts, & Other Low Engine Speed Applications			
B6001-005	6 Volt Alternator (1 Wire, Positive Ground)	\$166.50	
6 Volt, 40 Amp Alternator with Positive Ground, 1 Wire, 3/8" pulley			

Small ND Type

B6002-003	12 Volt Small Denso Alternator (1-Wire)	\$119.75
	40 Amp, 1 Wire Internal Regulator. Will Start Charging with a Much Lower Engine Speed. Comes with a 4 1/2" Housing Diameter, 3/8 To 1/2" Belt width & a 2 1/2" Pulley Diameter. Excellent for Converting a 6 Volt System to 12 Volt. Negative Ground Only & is Self-Excited	



ALTERNATOR BRACKETS

B9014-012	Massey Ferguson Alternator Mounting Bracket Kit	\$33.75
		Alternator Mounting Bracket Kit for Massey Ferguson TO-20/TE-20 Tractors Being Converted to a 10SI Alternator. Note: Only fits original Z120C500 block without optional tachometer drive. Will not fit late replacement blocks with mounting boss on the block (for the lower bracket).
B9014-013	Massey Ferguson Alternator Bracket Kit	\$28.99
		Alternator Mounting Bracket Kit for Massey Ferguson TO-30 (Gas/LP, only) & also 65, F40, MF35, MF50, TO-35 (Gas/LP, only; Serviceable w/ minor grinding on brackets for clearance)

ALTERNATOR CONVERSION KITS

B9021-004	Massey Ferguson Alternator Conversion Kit	\$190.75
		Alternator Conversion Kit with Mounting Brackets, 63 Amp, 1-Wire Alternator with 3/4" Belt Pulley, 12-Volt Ignition Coil (Internally Resisted), & Conversion Wiring Harness. **Will Allow Generator Indicator Light to Work**
Fits: TO-20/TE-20 (with Original Z120T500 Block) Does <u>Not</u> Fit Replacement Z120 Block with Lower Generator Mounting Bosses.		

LIGHTS & LIGHT PARTS

B9016-062	12V Headlight Assembly	\$49.99
	12 Volt, 5 3/4" Headlight. Stamped: TRACT-O-LITE on housing. Massey Ferguson Replaces (serviceable for): 186141M91, 186142M91, 510436M91, 510437M91 Fits: [Serviceable, w/ hood mounted lights: 35, 65, 85, 88, Super 90, 95, 97, 98, 135, 150, 165, 175, 202, 203, 204], TO-35 (SN: 161251 & up, or all TO-35 when converted to 12 Volt) When converted to 12 volt systems: TE-20, TEA-20, TO-20, TO-30	
B9016-063	6V Headlight Assembly	\$52.99
	6 Volt, 5 3/4" Headlight. Stamped: TRACT-O-LITE on housing. Massey Ferguson Fits (some with 4-cylinder gas and 6-volt system): TE-20, TEA-20, TO-20, TO-30, TO-35 (up to SN: 161250)	

PARTS FOR LIGHTS ABOVE		
B9017-033	Sealed Beam, 12 Volt Bulb	\$14.75
B9017-034	Sealed Beam, 6 Volt Bulb	\$19.75
	Double Contact High Beam 35 Watts with a 5.625" Outside Diameter	

Sealed Beam Head Lamp Assembly for Flat Top Fenders		
B9016-022	12 Volt Low Beam	\$39.99
B9016-023	12 Volt High Beam	\$59.75
B9016-080	12 Volt LED Trapezoid	\$67.99
B9016-081	12 Volt LED Flood Light	\$67.99
	Massey Ferguson Replaces: #505282M91, 505281M91, 509652M91, 509651M91 Fits: 1080, 1085, 1100, 1105, 1130	

PARTS FOR LIGHT ABOVE		
B9017-031	Sealed Beam, 12 Volt High Beam	\$18.99
B9017-032	Sealed Beam, 12 Volt Low Beam	\$16.50
	4 1/2" diameter Massey Ferguson Fits: : 1080, 1085, 1100, 1105, 1130	
	B9017-009	\$5.99
Concave Light Mounting Washer/Retainer		

B9017-097	12-Volt LED Lamp, Trapezoid Beam Pattern	\$49.99
	4 1/2" diameter Massey Ferguson Replaces: #1509347M1, 1751347M91, 1752866M91, 181856M91, 189544M91, 1002803M91 Fits: : 1080, 1085, 1100, 1105, 1130	
B9017-098	12-Volt LED Lamp, Flood Beam Pattern	\$49.99
	4 1/2" diameter Massey Ferguson Replaces: #285871M1, 505281M1, 509652M91 GE: #4410, 4411 Fits: : 1080, 1085, 1100, 1105, 1130	

B9016-064	12V Rear Work Light Assembly	\$109.99
	12 Volt Rear Work Light with Sealed Beam Bulb and On/Off Switch. Uses 4 1/2" Sealed Beam Bulbs. Outside Diameter is 5 1/4". Massey Ferguson Fits: TE-20, TO-20, TO-30	

PARTS FOR LIGHT ABOVE		
B9017-032	Sealed Beam, 12 Volt Low Beam	\$16.50
	4 1/2" diameter Double Contact Light Bulb 35 Watts 4.365" Outside Diameter	

B9016-054	Round Fender & Cab Mount Warning Light	\$19.99
	Restoration Quality 12 Volt Round Light with 2 x 4" Diameter Amber Lenses, Double Contact Bulb, 1/2" Diameter Stud, & 2.4" Thick at Widest Point. Massey Ferguson Replaces: #512566M91, 512567M91, 513058M91, 67750 Fits: 1080, 1085, 1100, 1105, 1130, 1135, 1150, 1155, 135, 150, 165, 175, 180, 230, 235, 240, 245, 250, 255, 265, 270, 275, 285, 298, 670, 698, 699	

B9016-055	Rectangular Fender & Cab Mount Warning Light	\$32.99
	Restoration Quality 12 Volt Rectangular Light One Red and One Amber Lens With Amber Side Marker 4.5" Wide & 1/2" Diameter Stud Massey Ferguson Fits: Various Models	



DASH LAMPS

B9016-013	Chrome Finish Dash Lamp	\$19.75
	6 or 12 Volt, Chrome Finished Dash Lamp. <i>Bulb not included.</i> 6 Volt Use Bulb #B9017-046 12 Volt Use Bulb #B9017-049 Massey Ferguson Replaces: #762269M91, 763868M91 Fits: Mustang (23), 33, 44, 55, 333, 444, 555	

B9016-014	Black Finish Dash Lamp	\$19.75
	6 or 12 Volt, Black Finished Dash Lamp. <i>Bulb not included.</i> 6 Volt Use Bulb #B9017-046 12 Volt Use Bulb #B9017-049 Massey Ferguson Replaces: #762269M91, 763868M91 Fits: Mustang (23), 33, 44, 55, 333, 444, 555	



B9016-044	Chrome Finish Dash Lamp	\$46.50
	12 Volt, Chrome Finished Dash Lamp. <u>Bulb not Included.</u> Purchase Bulb #B9017-049 if needed. Massey Ferguson Replaces: #1015377M1 Fits: 95, 97, 98	

Light Bulbs

B9017-046	6 Volt Bulb	\$1.25
B9017-049	12 Volt Bulb	\$1.25
	Light bulbs for products #B9016-013, #B9016-014, #B9016-044	
B9017-036	6-Volt Sealed Beam Bulb	\$14.50
	30-Watt, Double Contact, 4.5" Diameter, Low Beam Massey Ferguson Replaces: GE #4511 Fits: 35, 40, 50, 65, 85, 88, 90, 97, 135, 150, 165, 175, 180, 202, 203, 204, 770, 1080, 1085, 1100, 1105, 1130, Super 90, TE-20, TEA-20-85, TO-20, TO-30, TO-35	

GAUGES

Ammeters, Universal

B9025-002	Ammeter 20-0-20	\$19.99
	Has a black face with white lettering and a chrome bezel Does not have a logo Dimensions: Fits in 2" Diameter Hole 1.850" From Post to Bottom of Bezel	
B9025-005	Ammeter 30-0-30	\$19.99
	Has a chrome bezel. Massey Ferguson Replaces: #515521M91 Fits: 20, 30, 31, 35, 40, 50, 60, 65, 70, 80, 85, 88, 135, 150, 165, 175, 180, 202, 203, 204, 205, 302, 304, 356, 1001, 2135, 2200, 2500, Super 90, TO-30, TO-35	
B9025-008	Ammeter 60-0-60	\$19.99
	Has a black face with white lettering & a chrome bezel Uses threaded terminals and is dash mounted Used with 12-Volt Alternator Systems Dimensions:Fits in 2" Diameter Hole Measures 1.765" from Top of Post to Bottom of Bezel	

Oil Pressure Gauges

B9025-004	Universal Oil Pressure Gauge (0-50 PSI)	\$21.99
	This Gauge has 1/8" NPT Male Threads, This oil pressure Gauge has studs & a bracket. There is no logo included on this Gauge. It has a black face with white letters. This is a dash mounted Gauge that requires a 2" diameter hole. This Gauge has a chrome bezel. Massey Ferguson Fits: [Super 90, 35, 50, 65, 85, 88, 135, 150, 165, 202, 204, 406, 2135, 2200, 2500, 3165 (Gas/Lp)], 95, 97, Ferguson: F40, TE-20, TEA-20-85, TO-20, TO-30, TO-35 (Gas/Lp)	
B9025-001	Universal Oil Pressure Gauge (0-80 PSI)	\$24.99
	Has 1/8" NPT Male Threads, studs, & a bracket. Dash mounted, requires a 2" diameter hole. Massey Ferguson Replaces: #506902M92 Fits: 20, 30, 31, 35, 50, 60, 65, 70, 80, 85, 88, 135, 150, 165, 175, 180, 202, 203, 204, 205, 302, 304, 356, 1001, 2135, 2200, 2500, FE35, F40, Super 90, TE-20, TO-20, TO-30, TO-35	

Oil Pressure Gauge, Line Kit

B9026-001	Oil Pressure Gauge Line Kit	\$29.99
	6 FT copper 1/8" line --- Kit includes: (2) 5/16 - 24 UNF nut, (2) compression sleeves, (1) 1/8 - 27 NPTF female to 5/16" - 24 UNF male adapter --- Note: Depending on application customer may be required to purchase other fittings.	
B9026-004	Oil Pressure Gauge 1/4" to 1/8" NPT Adapter Fitting	\$15.99
	Adapter Fitting for Oil Gauges - 1/4" to 1/8" NPT. Massey Ferguson Fits: 40, TE-20, TEA-20, TO-20, TO-30, TO-35, MF Ag Tractor: 50	

Water Temperature Gauges,

B9025-006	Water Temperature Gauge	\$34.99
	Includes an Aluminum Sealing Washer to Seal Probe. 1/2" NPT Pipe Bushing and Probe Length of 1.279". Massey Ferguson Replaces: #1078125M91, 1079390M91, 180727M91, 180727M93, 182652M92, 1850512M94, 881396M91, 899455M91 Fits: 20, 30, 31, 35, 40, 50, 65, 85, 88, 135, 150, 165, 175, 180, 202, 203, 204, 205, 302, 304, 2135, 2200, 2500, 3165, FE35, Super 90, TE-20, TO-20, TO-30, TO-35, (And Other Models Using 60" Capillary Lead)	

B9025-007	Water Temperature Gauge	\$34.99
	Dash-mounted (parts included), 72" long heavy duty capillary tube included (check length before ordering) Massey Ferguson Fits: Ferguson: 20, 30, 31, 35, 40, 50, 60, 65, 70, 80, 135, 150, 165, 175, 180, 202, 203, 204, 205, 302, 356, 406, 1001, 2135, 2200, 2500, 3165, Super 90, TO-35, (And Others Using 72" Or Shorter Capillary Lead)	

B9032-002	2 Pole Auxiliary Connector	\$19.75
	(Used With B9032-001) Replaces: Massey Ferguson - #763868M91	

CIGARETTE LIGHTERS

Tachometer Drives

B9035-001	Tachometer Drive Assembly	\$46.50
	Has a 14 Tooth to 43 Tooth Gear Ratio. Includes Gaskets. Massey Ferguson Replaces: #1751295M91, 1751298M1, 1751299M91, 835086M1, 1751301M92, 1751304M91 Fits: TO-20, TO-30, TO-35 (Continental Gas / LP), Ferguson: 40 (Continental Gas / LP), MF (Ag & Ind): 50 (Continental Gas / LP), 1080 (Diesel Perkins), 1100 (Gas-LP with Waukesha), [135, 150, 165, 175, 180, 35, 65, 85, 88, Super 90 (Continental Gas / LP)], 97 (Gas or Diesel)	

B9030-003	12 Volt Cigarette Lighter	\$27.99
	The knob is black plastic with the word 'lighter' in white printing. Massey Ferguson Replaces: #677277 Fits: 35, 50, 65, 85, 88, 135, 150, 165, 175, 180, 235, 265, 275, 285, 1080, 1085, 1100, 1130, 1150, FE35, Super 90 (with 12-volt systems), TO-35 (with 12-volt systems, SN: 161251 & up) Industrial: 20C, 30, 31, 40, 50, 60, 70, 202, 203, 204, 205, 302, 304, 356, 2135, 2200 Forklift, 2500 Forklift MF Overseas (UK built): 35 (with 12-volt systems) MF French Farm Tractor: 130 (with 12-volt systems)	

STARTERS

Tachometer Drive Cables

B9026-003	56" Tachometer Drive Cable	\$34.99
	Restoration Quality. Drive Cable for Tachometers. Measures 56" Outer Sheath Length. 5/8"-18 x 7/8"-18 Threads With Key On One End. Please Check Length Before Ordering. Massey Ferguson Replaces: #544198M91	

4762N	6 Volt Starter	\$195.25
	New 6-Volt Replacement Starter Fits: Massey Ferguson - Massey Ferguson TO-20, & TO-30 Replaces: Delco - #1109457	

B9026-008	38 7/8" Tachometer Drive Cable	\$21.99
	Measures 38 7/8" long with a metal sheath. Has square ends with 5/8" - 18 x 7/8" - 18 threads. Massey Ferguson Replaces: #1751284M91, 506331M91, 506334M91, 521596M91, 532426M92 Fits (Continental Gas Tractors): TO-35, 35, 40, 50, 135, 150, 165, 175. Industrials: 30, 202, 204, 2135, 3165	

STARTER SWITCHES & SOLENOIDS

AUXILIARY PLUG & SOCKET

B9032-001	2 Pole Auxiliary Plug	\$23.75
	Replaces: Massey Ferguson - #763868M91	

B5006-002	Starter Switch (Short Shaft Autolite Type)	\$15.75
	Replaces: Autolite - #SW-4012(15-49) Delco - #1996478 Massey Ferguson - #829960M31 Fits: Massey Harris - TO-20, TO-30	

B5007-002	12 Volt Solenoid	\$17.50
	12 Volt, 3 Terminal Solenoid With A Curved Mounting Bracket Fits: Massey Ferguson - TO-35 (With Starter #1108649), 40, 50, 65	

B5007-010	12 Volt Solenoid (Manual Push Button)	\$20.00
	12 Volt, 3 Terminal Solenoid With A Curved Mounting Bracket & Manual Push Button. Replaces: Autolite - SAE-4005, 15-60, SAW-4201 Fits: Massey Ferguson - TO-35 (With Starter #1108649), 40, 50, 65	

B5007-017	12 Volt Lucas Solenoid	\$29.75
	12 Volt Rated Solenoid with 4 Terminals for Lucas M45G, M127, M418G Starters. 2 Hole Mount Stud & Removable Plunger. Replaces: Lucas - #76755, 76763, 76786, 76796, 76800, 76803, 76804, 76815, 76816, 76820, 76821, 76823, 76824, 76826, 76827, 76837, 76850, 76852, 76855, 76871, 76885, 76891, 76892, 76894, 76895, 76896, 76897, 76899, 76902, 76908, 76940, 76961, 76982, 76983, 77034, 77035, 77058, 77157, 77160, TOB109, TOB113, TOB121, TOB128, TOB134, TOB162, TPB107 Massey Ferguson - #3475771M91 Fits: Massey Ferguson - 20, 35, 40, 50, 65, 135, 148, 150, 165, 184, 203, 230, 235, 240 (S/N N01001-A20286), 245, 255, 360, 364, 364S (S/N D03066-Earlier), 550, 2135	

B5007-024	Delco 12 Volt Solenoid	\$109.50
	12 Volt Rated Solenoid for Delco 40MT & 50MT Direct Drive Starters with 4 Terminals. Replaces: Delco #1119835, 1119853, 1119862, 1119879, 1119895 Massey Ferguson - #1022662M91, 1055740M91 Fits: Massey Ferguson - 97, 1150, 1155, 1500, 1505, 1800, 1805, 2745, 2775, 2805, 4800, 4900	

MOMENTARY SWITCHES

B5004-001	Momentary Push Switch	\$14.00
	Manual Push Button Solenoid Switch (2 Screw Terminals) Mounting Stem 5/8"-32 Thread Massey Ferguson - TO-20, TO-30, TO-35, 40, 50, 65	

PUSH/PULL SWITCHES

B5002-010	Light Switch	\$16.00
	Like Original (Uses Pigtail Connectors & 20 Amp Fuse) Massey Ferguson Fits: TE-20, TEA-20, TO-20, TO-30 Replaces: #830517M91	

CARBURETOR REBUILD KITS

B9022-003	Marvel Schebler Carburetor Rebuild Kit	\$24.99
	Massey Ferguson Tractors Model 85, 88, Super 90 Fits Carburetor: Marvel-Schebler Carburetor: #TSX-27, TSX-27A, TSX-62, TSX-93, TSX-162, TSX-644, TSX-779, TSX-786, TSX-786-1, TSXU-837, TSXU-838, TSXU-839, TSX-916 Massey Ferguson Carburetor: #6376-A, 6388-A, 6688-A, 6709-A, 184-845-M91, 186-602-M91, 186-602-M92, 770-170-M91, 512627-M91	

B9022-005	Marvel Schebler Carburetor Rebuild Kit	\$23.99
	Massey Ferguson Tractors Model 1001, 150, 165, 175, 180, 302, 303, 304, 356, 65, DX-45 (Military), 65, DX-65 (Military) Fits Carburetor: Marvel-Schebler Carburetor: TSX1001, TSX1002, TSX181, TSX221, TSX245, TSX296, TSX332, TSX360, TSX374, TSX397, TSX413, TSX414, TSX436, TSX464, TSX466, TSX475, TSX492, TSX505, TSX506, TSX506A, TSX526, TSX528, TSX530, TSX561, TSX562, TSX563, TSX575, TSX582, TSX592, TSX596, TSX602, TSX605, TSX606, TSX610, TSX615, TSX633, TSX639, TSX641, TSX645, TSX648, TSX662, TSX678, TSX688, TSX689, TSX695, TSX704, TSX711, TSX713, TSX719, TSX721, TSX725, TSX732, TSX737, TSX738, TSX755, TSX756, TSX757, TSX759, TSX768, TSX769, TSX772, TSX773, TSX775, TSX777, TSX784, TSX788, TSX791, TSX792, TSX797, TSX798, TSX799, TSX800, TSX801, TSX806, TSX808, TSX810, TSX811, TSX813, TSX814, TSX816, TSX819, TSX825, TSX836, TSX843, TSX849, TSX853, TSX854, TSX856, TSX857, TSX867, TSX869, TSX871, TSX877, TSX878, TSX881, TSX883, TSX884, TSX885, TSX886, TSX888, TSX889, TSX892, TSX892S, TSX893, TSX894, TSX895, TSX897, TSX898, TSX899, TSX900, TSX902, TSX903, TSX904, TSX904SL, TSX905, TSX905-1, TSX905SL, TSX906, TSX906SL, TSX907, TSX907SL, TSX908, TSX908SL, TSX911, TSX917, TSX920, TSX920SL, TSX921SL, TSX922, TSX922SL, TSX923, TSX923SL, TSX925, TSX927, TSX928, TSX932, TSX932SL, TSX933, TSX934, TSX934SL, TSX938, TSX938SL, TSX939, TSX940, TSX940SL, TSX941, TSX941SL, TSX942, TSX943, TSX944SL, TSX945SL, TSX946, TSX947SL, TSX949, TSX950, TSX952, TSX952SL, TSX955, TSX959, TSX959SL, TSX961, TSX961SL, TSX962, TSX962SL, TSX964SL, TSX965SL, TSX966, TSX967SL, TSX968SL, TSX97, TSX972, TSX973, TSX974, TSX974SL, TSX975, TSX975SL, TSX977, TSX980, TSX980SL, TSX984SL, TSX985, TSX985SL, TSX988, TSX989, TSX993, TSX994, TSX997, TSX998, TSX999, TSXU1006, TSXU1007, TSXU835, TSXU836, TSXU840, TSXU904, TSXU904SL, TSXU905, TSXU905-1, TSXU944SL, TSXU963, TSXU9631, TSXU995 Replaces: Massey Ferguson - #184301M92, 184301M92, 190383M92, 191494M91, 194603M92, 194603M92, 2047421M1, 204742M1, 206350M1, 220634M91, 506003M92, 506003M92, 520736M91, 520736M92, 6376A, 700846M91, 761301M91, 764920M91, 764920M91, 766225M91, 766225M91, 766576M91, 768190M91, 768190M91, 768191M91, 768191M91, 770079M91, GK3992, GR2110	

B9022-011	Zenith Carburetor Rebuild Kit	\$24.99
 <p>Massey Ferguson Tractors Model 65, 135, 165, 235, 245, 3135, 3165, 6000 Fits Carburetor: Zenith Carburetor #12548, 12992, 12994, 13236, 13316, 13337, 13338, 13372, 13762, 137795, 14991, 14992 Massey Ferguson Carburetor #194-996-M93, 515-509-M92, 517-099-M91, 517-678-M91, 535-574-M91, 673-254-M92, 674-369-M91</p>		

B9022-023	Marvel Schebler Carburetor Rebuild Kit	\$24.50
 <p>Massey Ferguson Tractor Model 135, 2135 (Early), 150, 202, 204, 35, 50, F40, TE-20, TO-20, TO-30, TO-35 Fits Carburetor: Marvel-Schebler Carburetor: #1004SL, TSX101, TSX102, TSX103, TSX112, TSX113, TSX114, TSX119, TSX120, TSX126, TSX128, TSX13, TSX132, TSX132A, TSX133, TSX134, TSX136, TSX137, TSX138, TSX140, TSX141, TSX142, TSX144, TSX146, TSX147, TSX148, TSX150, TSX151, TSX154, TSX155, TSX156, TSX157, TSX159, TSX161, TSX167, TSX171, TSX173, TSX179, TSX180, TSX182, TSX183, TSX184, TSX186, TSX188, TSX189, TSX190, TSX191, TSX192, TSX193, TSX194, TSX197, TSX198, TSX202, TSX203, TSX206, TSX206-1, TSX211, TSX212, TSX225, TSX228, TSX231, TSX237, TSX239, TSX239-1, TSX240, TSX241A, TSX241B, TSX241C, TSX246, TSX248, TSX253, TSX254, TSX258, TSX260, TSX264, TSX266, TSX267, TSX269, TSX272, TSX274, TSX278, TSX28, TSX280, TSX286, TSX287, TSX288, TSX289, TSX29, TSX290, TSX297, TSX30, TSX301, TSX305, TSX306, TSX308, TSX309, TSX312, TSX314, TSX315, TSX319, TSX322, TSX323, TSX326, TSX328, TSX33, TSX330, TSX331, TSX332, TSX333, TSX334, TSX335, TSX338, TSX339, TSX34, TSX341, TSX346, TSX347, TSX348, TSX35, TSX351, TSX352, TSX356, TSX357, TSX358, TSX359, TSX36, TSX361, TSX361-A, TSX363, TSX366, TSX367, TSX368, TSX37, TSX370, TSX370-1, TSX377, TSX38, TSX380, TSX388, TSX389, TSX39, TSX391, TSX398, TSX400, TSX403, TSX405, TSX406, TSX407, TSX409, TSX418, TSX419, TSX42, TSX420, TSX421, TSX422, TSX423, TSX428, TSX43, TSX44, TSX443, TSX447, TSX448, TSX45, TSX450, TSX452, TSX453, TSX455, TSX458, TSX459, TSX465, TSX470, TSX472, TSX474, TSX48, TSX480, TSX481, TSX484 TSX486, TSX49, TSX497, TSX500, TSX507, TSX510, TSX513, TSX514, TSX516, TSX518, TSX520, TSX525, TSX531, TSX532, TSX534, TSX539, TSX54, TSX541, TSX55, TSX551, TSX552, TSX556, TSX558, TSX560, TSX567, TSX569, TSX570, TSX573, TSX577, TSX58, TSX580, TSX589, TSX59, TSX593, TSX595, TSX597, TSX60, TSX603, TSX605, TSX606, TSX611, TSX614, TSX618, TSX626, TSX633, TSX635, TSX643, TSX646, TSX649, TSX649-1, TSX650, TSX653, TSX655, TSX656, TSX660, TSX663, TSX665, TSX668, TSX670, TSX671, TSX676, TSX680, TSX681, TSX683, TSX69, TSX690, TSX691, TSX692, TSX694, TSX696, TSX701, TSX706, TSX709, TSX710, TSX714, TSX730, TSX736, TSX74, TSX742, TSX744, TSX748, TSX753, TSX76, TSX762, TSX765, TSX767, TSX770, TSX771, TSX776, TSX776-1, TSX78, TSX781, TSX787, TSX79, TSX793, TSX796, TSX80, TSX802, TSX803, TSX804, TSX809, TSX812, TSX815, TSX820, TSX826, TSX827, TSX83, TSX830, TSX841, TSX844, TSX85, TSX851, TSX855, TSX857, TSX860, TSX862, TSX864, TSX865, TSX866, TSX879, TSX88, TSX882, TSX89, TSX896, TSX896SL, TSX90, TSX901, TSX91, TSX912, TSX913, TSX914, TSX919, TSX926, TSX930, TSX931, TSX936, TSX936SL, TSX937, TSX937SL, TSX94, TSX948, TSX949, TSX95, TSX954, TSX957, TSX957SL, TSX95A, TSX96, TSX971, TSX976, TSX978, TSX979, TSX979-1, TSX98, TSX983, TSX986...</p>		

...TSX987, TSX99, TSX990, TSX991, TSX991-1, TSX996, TSXU828, TSXU829, TSXU830, TSXU831, TSXU832, TSXU833, TSXU834, 1003
Massey Ferguson Carburetor:
#181532M91, 181643M91, 181644M91, 181740M91, 183576M91, 194065M92, 6195A, 6195A, 6307A, 6371A, 6401A, 6683A, 6684, 6688A, 761301M91, 761304M91, 852186M1, T09510, T09510-1

B9022-029	Premium Marvel-Schebler Carburetor Rebuild Kit	\$69.99
 <p>Massey Ferguson Tractors Models TE-20, TO-20 Includes: brass plugs, choke plate, choke shaft, drain petcock, float pin, fuel strainer, gaskets, metering nozzle, needle and seat, throttle plate, throttle shaft, throttle shaft bushings and packing, instruction sheet, and more! Fits: Marvel-Schebler Carburetor: #TSX361, TSX361A</p>		

B9022-024	Carter Carburetor Rebuild Kit	\$44.99
 <p>Massey Ferguson Replaces: 181578M91, 182748M91, 184458M91 Fits: F40, TO-30, TO-35, 35, 50, 202</p>		

CARBURETOR FLOATS

B9023-003	Marvel-Schebler Carburetor Float	\$12.75
 <p>Massey Ferguson Tractors Model TE20, TO-20, TO-30, TO-35, 35, 135, 150 Fits Carburetor: Marvel-Schebler Carburetor: #TSX27A, TSX-28, TSX-34, TSX-55, TSX-88, TSX-155, TSX-188, TSX228, TSX-248, TSX-272, TSX-308, TSX-309, TSX-312, TSX-361, TSX-361A, TSX-458, TSX-541, TSX-605, TSX-683, TSX-882, TSXU-831, TSXU-832, TSXU-834 Massey Ferguson Carburetor: #6195-A, 6307-A, 6371-A, 6401-A, 6683-A, 6684-A, 852186, 1810532-M91, 181-643-M91, 181-644-M91, 181-740-M91, 183-576-M91, 194064-M92, 194065-M92, 761-301-M91, 761-304-M91, TO-9510, TO-9510-1, TO-9510-B1 Replaces: Massey Ferguson: #15480A Marvel Schebler: #30-600</p>		

B9023-015	Zenith Carburetor Float	\$24.99
 <p>Massey Ferguson Tractors Model 65, 135, 165, 175, 180, 235, 245, 255, 265 Replaces:Zenith: #C85-115, C85-115S Fits Carburetor: (various- see our website)</p>		

B9023-004	Marvel-Schebler Carburetor Float	\$19.95
	<p>Massey Ferguson Tractors Model DX-45 (Military), 65, DX-65 (Military) MF-150, MF-302, MF-303, MF-304, MF-356, MF-1001 Fits Carburetor: Marvel-Schebler Carburetor: #TSX-505, TSX-506, TSX-506A, TSX-592, TSX-596, TSX-695, TSX-772, TSX-843, TSX-856, TSX-884, TSX-893, TSX-947SL, TSXU-835, TSXU-836, TSXU-840, TSXU-963 Massey Ferguson Carburetor: #184-301-M92, 190-383-M91, 190-383-M92, 191-494-M91, 520-736-M91, 764-920-M91, 766-576-M91, 768-190-M91, 768-191-M91770-079-M91 Replaces: Massey Ferguson: #1508838M91 Marvel Schebler: #30-631, 30-739</p>	

B9023-012	Marvel-Schebler Carburetor Float	\$19.75
	<p>Massey Ferguson Tractors Model 85, 88, Super 90 Fits Carburetor: Marvel-Schebler Carburetor: #TSX-27, TSX-62, TSX-93, TSX-162, TSX-308, TSX-644, TSX-786, TSX-786-1 Replaces: Marvel Schebler: #30-621</p>	

FUEL SEDIMENT BOWLS

B9036-002	Fuel Sediment Bowl	\$34.99
	<p>Has a 3/8" Pipe Inlet, 1/8" Pipe Outlet, and a 2.315" tall glass bowl Massey Ferguson Replaces: 189408M91, 193995M91, 505472M91 Fits (Using 2.315 tall glass bowl): 20, 30 Gas, 85 Gas (SN: 807752 & Up), 135 Gas, 150 (Continental Gas only), 165, 175, 180 Gas, 202 Late Gas, 204, 303 Gas, Super 90 Gas (up to SN: 888673)</p>	

Parts for Sediment Bowl Above

B9038-024	Connector w/ Female Fitting	\$8.99
B9038-008	2" Sediment Bowl Screen	\$3.99
B9038-012	Sediment Bowl Gasket	\$2.99

B9036-003	Fuel Sediment Bowl	\$20.75
	<p>Has a 3/8" Pipe Inlet and a 1/4" Pipe Outlet. Massey Ferguson Replaces: #180141M91 Fits: TO-20, TE-20, TO-30, [TO-35, 35 Gas], 40, [50, 65 Gas], [85 Gas, To Sn: 807751 Using 1.280 Tall Glass Bowl], [88 Gas], [SUPER 90 Gas, Sn: 888674 & Up, Using 1.280 Tall Glass Bowl], [202 up to sn 309328], [204 up to sn 343891]</p>	

B9038-007	2" Sediment Bowl Gasket	\$2.19
	<p>2" Outer Diameter, Bowl to Body; Fits a 1.28" Tall Glass Bowl Massey Ferguson Replaces: 180060M1 Fits: TE-20, TO-20, TO-30, TO-35 (Gas): 35, 40, 50, 65, 85 (to SN: 807751 w/ 1.280" long glass bowl), 88, Super 90 (SN: 888674 & up, w/ 1.280" long glass bowl), 202 (up to SN: 309328), 204 (up to SN: 343891)</p>	

B9038-011	Sediment Bowl Screen	\$2.75
	<p>1 3/4" Diameter, Square Hole Screen, Silicon Bronze Alloy Fits B9036-003 above</p>	

B9038-025	Fuel Line Adapter Fitting	\$5.99
	<p>1/8" NPT male to 5/16" flare fitting for 5/16" fuel line Includes one 5/16" flare fuel line fitting Replaces: #1851802M2</p>	

CARBURETOR ACCESSORIES

B9038-003	Carburetor Elbow Fuel Line Fitting with Strainer	\$7.99
	<p>Elbow Fuel Line Fitting with strainer for IHC carburetors. 1/8" Pipe to 1/4" Flare. Works with Carter UT Series and Various Marvel-Schebler Carburetors. Replaces: #1751172M91, 1751212M91 Fits: Massey Ferguson - TO-20, TE-30, TO-30, TO-35, 35, 50, 135, 150, 202, 204, F40</p>	

TRANSMISSION ACCESSORIES

B9039-004	Shift Lever Boot	\$5.99
	<p>0.510" Shift Lever Hole I.D. 1.600" I.D. for the Bottom of the Boot Two Boots Used Per Tractor: One on Gear Shift Lever, One on Hi - Lo Shift Lever Massey Ferguson Replaces: #1678565M1, 520858M1 Fits: F40, FE35 (Overseas), 35, 50, 65, 85, 88, Super 90, 135, 150, 165, 175, 230, 235, 245, 240, 255, 265, 275, TO-35</p>	

FUEL SYSTEM ACCESSORIES

B9038-009	Fuel Cap	\$10.99
	<p>Chrome Plated, 2.7" Outside Diameter, 1.88" Overall Tab Length, .25" Tab Width Massey Ferguson Replaces: 850493M1 Fits: 35, 40, 50, 65, 85, 88, Super 90, 135, 150, 165, 175, 1080, 1100, 1130, TE-20 (If not threaded), TO-20, TO-30, TO-35</p>	

MASSEY HARRIS

TABLE OF CONTENTS

Spark Plug Wire Sets	326
Battery Cables	327
Wire Harnesses	329
Tune Up Parts for Battery Ignition	332
Electronic Ignition Conversion Kits	333
Tune Up Parts for Magneto Ignition	333
Gauges	335
Tachometer Drives	335
Switches	336
Cutout Relays & Voltage Regulators	337
Brush Sets	338
Identification Tags	338
Alternators	338
Lights & Light Parts	339
Cigarette Lighters	339
Dash Grommets, Carburetor Rebuild Kits	340
Carburetor Floats	341
Carburetor Accessories	342
Fuel Sediment Bowls	342

SPARK PLUG WIRE SETS

Our Spark Plug Wire Sets Come Fully Assembled with the Proper Type Wire & Terminals, Custom Tailored to Look & Fit Like Original Factory Equipment.

Varieties include:

Cotton Braid Wire: Copper Core with a Cotton Jacket.

PVC Wire: Copper Core with a Rubber Jacket.

EPDM Wire (E): Hi Performance Premium Conductor with a Tinned Copper Core, EPDM Silicone Insulation, and a Rubber Jacket.

Suppression Wire (S): for Electronic Ignition and is Spiral Wound, Ultra Low-Ohm, with EPDM Silicone Insulation and a Rubber Jacket.

Cotton Braid Suppression Wire (CS): also for Electronic Ignition, as Suppression Wire, but has an additional layer of Cotton Braid & Lacquer to replicate the vintage look, as well.



Massey Harris 4-Wheel Drive GP

4 Cyl. Tailored Spark Plug Wire Set with Flathead Valve

B1034-001	Original Type Cotton Braid Wire	\$29.75
B1034-001E	EPDM Wire	\$32.50

with Overhead Valve

B1034-032	Original Type Cotton Braid Wire	\$29.75
B1034-032E	EPDM Wire	\$32.50

Massey Harris Pacemaker

4 Cyl. Tailored Spark Plug Wire Set

B1034-002	Original Type Cotton Braid Wire	\$29.75
B1034-002E	EPDM Wire	\$32.50

Massey Harris Challenger

4 Cyl. Tailored Spark Plug Wire Set

B1034-003	Original Type Cotton Braid Wire	\$29.75
B1034-003E	EPDM Wire	\$32.50

Massey Harris 11 Pony

4 Cyl. Tailored Spark Plug Wire Set

B1034-004	Original Type Cotton Braid Wire	\$23.75
B1034-004E	EPDM Wire	\$26.00
B1034-004S	Suppression Wire	\$26.00
B1034-004CS	Cotton Suppression Wire	\$40.75

Massey Harris 16 Pacer

4 Cyl. Tailored Spark Plug Wire Set

B1034-005	Original Type Cotton Braid Wire	\$23.75
B1034-005E	EPDM Wire	\$26.00
B1034-005S	Suppression Wire	\$26.00
B1034-005CS	Cotton Suppression Wire	\$40.75

Massey Harris 20, 21 Colt, 22, 23 Mustang, & 30

4 Cyl. Tailored Spark Plug Wire Set

Replaces: #TO7529, TGO7624, T11213, 840169M91

B1034-006	Original Type Cotton Braid Wire	\$23.75
B1034-006E	EPDM Wire	\$26.00
B1034-006S	Suppression Wire	\$26.00
B1034-006CS	Cotton Suppression Wire	\$40.75

Massey Harris 25

4 Cyl. Tailored Spark Plug Wire Set

B1034-010	Original Type Cotton Braid Wire	\$32.25
B1034-010E	EPDM Wire	\$35.50

Massey Harris 33

4 Cyl. Tailored Spark Plug Wire Set

B1034-012	Original Type Cotton Braid Wire	\$23.75
B1034-012E	EPDM Wire	\$26.00
B1034-012S	Suppression Wire	\$26.00
B1034-012CS	Cotton Suppression Wire	\$40.75

Massey Harris 44

4 Cyl. Tailored Spark Plug Wire Set

B1034-013	Original Type Cotton Braid Wire	\$23.75
B1034-013E	EPDM Wire	\$26.00
B1034-013S	Suppression Wire	\$26.00
B1034-013CS	Cotton Suppression Wire	\$40.75

Massey Harris 44D

1 Cyl. Tailored Spark Plug Wire Set

B1034-014	Original Type Cotton Braid Wire	\$8.00
B1034-014E	EPDM Wire	\$9.00

Massey Harris 44-6

6 Cyl. Tailored Spark Plug Wire Set

B1034-015	Original Type Cotton Braid Wire	\$35.75
B1034-015E	EPDM Wire	\$39.25

Massey Harris 50

4 Cyl. Tailored Spark Plug Wire Set

B1034-016	Original Type PVC Wire	\$20.00
B1034-016E	EPDM Wire	\$24.00
B1034-016S	Suppression Wire	\$24.00

Massey Harris 55

4 Cyl. Tailored Spark Plug Wire Set

B1034-017	Original Type Cotton Braid Wire	\$23.75
B1034-017E	EPDM Wire	\$26.00
B1034-017S	Suppression Wire	\$26.00
B1034-017CS	Cotton Suppression Wire	\$40.75

Massey Harris 81

4 Cyl. Tailored Spark Plug Wire Set

B1034-006	Original Type Cotton Braid Wire	\$23.75
B1034-006E	EPDM Wire	\$26.00
B1034-006S	Suppression Wire	\$26.00
B1034-006CS	Cotton Suppression Wire	\$40.75

Massey Harris 82

4 Cyl. Tailored Spark Plug Wire Set

B1034-019	Original Type Cotton Braid Wire	\$23.75
B1034-019E	EPDM Wire	\$26.00
B1034-019S	Suppression Wire	\$26.00
B1034-019CS	Cotton Suppression Wire	\$40.75

Massey Harris 101, 102 Junior

Early (1939-1942) with Continental Engine

4 Cyl. Tailored Spark Plug Wire Set

B1034-020	Original Type Cotton Braid Wire	\$23.75
B1034-020E	EPDM Wire	\$26.00

Late (1943 & Later) with Continental Engine

4 Cyl. Tailored Spark Plug Wire Set

B1034-031	Original Type Cotton Braid Wire	\$23.75
B1034-031E	EPDM Wire	\$26.00
B1034-031S	Suppression Wire	\$26.00
B1034-031CS	Cotton Suppression Wire	\$40.75

Massey Harris 101 Senior

6 Cyl. Tailored Spark Plug Wire Set

B1034-022	Original Type Cotton Braid Wire	\$35.75
B1034-022E	EPDM Wire	\$39.25

Massey Harris 101 Super

6 Cyl. Tailored Spark Plug Wire Set

B1034-023	Original Type Cotton Braid Wire	\$35.75
B1034-023E	EPDM Wire	\$39.25
B1034-023S	Suppression Wire	\$39.25

Massey Harris 102 Junior

(See #B1034-020 or B1034-031 above)

Massey Harris 102 Senior

6 Cyl. Tailored Spark Plug Wire Set

B1034-024	Original Type Cotton Braid Wire	\$35.75
B1034-024E	EPDM Wire	\$39.25

Massey Harris 201

6 Cyl. Tailored Spark Plug Wire Set

B1034-025	Original Type Cotton Braid Wire	\$35.75
B1034-025E	EPDM Wire	\$39.25

Massey Harris 202

6 Cyl. Tailored Spark Plug Wire Set

B1034-026	Original Type Cotton Braid Wire	\$35.75
B1034-026E	EPDM Wire	\$39.25

Massey Harris 203

6 Cyl. Tailored Spark Plug Wire Set

B1034-027	Original Type Cotton Braid Wire	\$35.75
B1034-027E	EPDM Wire	\$39.25

Massey Harris 333

4 Cyl. Tailored Spark Plug Wire Set

B1034-028	Original Type PVC Wire	\$20.50
B1034-028E	EPDM Wire	\$24.50
B1034-028S	Suppression Wire	\$24.50

Massey Harris 444

4 Cyl. Tailored Spark Plug Wire Set

B1034-029	Original Type PVC Wire	\$20.50
B1034-029E	EPDM Wire	\$24.50
B1034-029S	Suppression Wire	\$24.50

Massey Harris 555

4 Cyl. Tailored Spark Plug Wire Set

B1034-030	Original Type PVC Wire	\$21.50
B1034-030E	EPDM Wire	\$26.00
B1034-030S	Suppression Wire	\$26.00

BATTERY CABLES



Our Battery Cables are made from the Proper Gauge Copper, as either Black Cotton Braided Wire or PVC Wire (whichever is correct for the application), using Soldered & Heat Sealed Brass or Copper Terminals.

Massey Harris 4 Wheel Drive GP

B2034-001	Negative Battery Cable	\$20.25
B2034-002	Positive Battery Cable	\$22.75
B2034-003	Switch to Starter Cable	\$60.00

Massey Harris 11 Pony

B2034-004	Negative Battery Cable	\$27.00
B2000-005	Positive Ground Strap	\$12.50

Massey Harris 16 Pacer

B2034-005	Negative Battery Cable	\$27.00
B2000-005	Positive Ground Strap	\$12.50

Massey Harris 20

B2034-006	Negative Battery Cable	\$26.00
B2034-007	Positive Battery Cable	\$35.75
B2034-008	Switch To Starter Battery Cable	\$44.00

Massey Harris 21 Colt

B2034-009	Negative Battery Cable	\$22.00
B2034-010	Positive Battery Cable	\$27.00
B2034-011	Switch To Starter Battery Cable	\$47.00

Massey Harris 22

B2034-012	Negative Battery Cable	\$26.00
B2034-013	Positive Battery Cable	\$35.75
B2034-014	Switch to Starter Cable	\$44.00

Massey Harris 23 Mustang

B2034-015	Negative Battery Cable	\$22.00
B2034-016	Positive Battery Cable	\$27.00
B2034-017	Switch to Starter Cable	\$47.00

Massey Harris 30/30K

B2034-018	Negative Battery Cable Replaces: #21470A	\$35.75
B2034-019	Positive Battery Cable Replaces: #14532A	\$35.75
B2034-020	Switch to Starter Cable Replaces: #21472A	\$51.75

Massey Harris 33 (Up to Serial #G15E7686)

B2034-024	Negative Battery Cable	\$35.75
B2034-025	Positive Battery Cable	\$31.75
B2034-026	Switch to Starter Cable	\$56.50

Massey Harris 33 (Serial #G15E7686 & Up)

B2034-027	Negative Battery Cable	\$35.75
B2034-028	Positive Battery Cable	\$30.00
B2034-029	Switch to Starter Cable	\$51.75

Massey Harris 33 Diesel

B2034-030	Negative Battery Cable	\$36.50
B2034-031	Positive Battery Cable	\$37.50
B2034-032	Battery to Battery Jumper Cable	\$65.00
B2034-033	Switch to Starter Cable	\$32.00

Massey Harris 44 Gas Row Crop

B2034-034	Negative Battery Cable	\$35.75
B2034-035	Positive Battery Cable	\$31.75
B2034-036	Switch to Starter Cable	\$65.50

Massey Harris 44 Kerosene Row Crop

B2034-037	Negative Battery Cable	\$35.75
B2034-038	Positive Battery Cable	\$31.75
B2034-039	Switch to Starter Cable	\$65.50

Massey Harris 44 LP Row Crop

B2034-040	Negative Battery Cable	\$35.75
B2034-041	Positive Battery Cable	\$31.75
B2034-042	Switch to Starter Cable	\$52.75

Massey Harris 44 Gas Standard

B2034-043	Negative Battery Cable	\$35.75
B2034-044	Positive Battery Cable	\$27.00
B2034-045	Switch to Starter Cable	\$51.50

Massey Harris 44 Special

B2034-046	Negative Battery Cable	\$35.75
B2034-047	Positive Battery Cable	\$31.75
B2034-048	Switch to Starter Cable	\$49.25

Massey Harris 44-6

B2034-049	Negative Battery Cable	\$36.25
B2034-050	Positive Battery Cable	\$31.75
B2034-051	Switch to Starter Cable	\$55.00

Massey Harris 50

B2034-052	Positive Battery Cable	\$26.50
B2000-010	Negative Ground Strap	\$21.75
B2034-117	Switch to Starter Cable	\$19.75

Massey Harris 55 Gas

B2034-116	Positive Battery Cable	\$22.50
B2034-056	Negative Battery Cable	\$29.25
B2034-057	Switch to Starter Cable	\$53.50

Massey Harris 55 Diesel

B2000-007	Positive Ground Strap	\$14.50
B2034-058	Positive Battery Cable	\$37.50

Massey Harris 81

B2034-059	Negative Battery Cable	\$26.00
B2034-060	Positive Battery Cable	\$35.75
B2034-061	Switch to Starter Cable	\$44.00

Massey Harris 82

B2034-062	Negative Battery Cable	\$26.00
B2034-063	Positive Battery Cable	\$35.75
B2034-064	Switch to Starter Cable	\$44.00

Massey Harris 101 Junior, 102 Junior

B2034-065	Negative Battery Cable	\$27.75
B2034-066	Positive Battery Cable	\$30.75
B2034-067	Switch to Starter Cable	\$44.75

Massey Harris 101 Senior

B2034-068	Negative Battery Cable	\$27.00
B2034-069	Positive Battery Cable	\$30.00
B2034-070	Switch to Starter Cable	\$32.50

Massey Harris 101 Super

B2034-074	Negative Battery Cable	\$27.00
B2034-075	Positive Battery Cable	\$30.00
B2034-076	Switch to Starter Cable	\$44.00

Massey Harris 201, 202, 203

B2034-077	Negative Battery Cable	\$27.00
B2034-078	Positive Battery Cable	\$27.00
B2034-079	Switch to Starter Cable	\$47.75

Massey Harris 333 Gas

B2034-086	Positive Battery Cable	\$33.00
B2034-087	Negative Battery Cable	\$38.75
B2034-088	Switch to Starter Cable	\$33.00

Massey Harris 333 Kerosene

B2034-089	Positive Battery Cable	\$33.00
B2034-090	Negative Battery Cable	\$38.75
B2034-091	Switch to Starter Cable	\$33.00

Massey Harris 333 LP

B2034-092	Positive Battery Cable	\$35.75
B2034-093	Negative Battery Cable	\$34.50
B2034-094	Switch to Starter Cable	\$28.75
B2034-095	Battery to Battery Jumper Cable	\$30.75

Massey Harris 333 Diesel

B2034-096	Negative Battery Cable	\$36.50
B2034-097	Positive Battery Cable	\$81.50
B2034-098	Starter Solenoid to Heater Switch	\$54.75
B2034-099	Heater Switch to Heater Cable	\$58.75
B2034-100	Battery to Battery Cable	\$26.00

Massey Harris 444 Gas

B2034-101	Negative Battery Cable	\$38.75
B2034-102	Positive Battery Cable	\$33.00
B2034-103	Switch to Starter Cable	\$33.00

Massey Harris 444 Kerosene

B2034-104	Negative Battery Cable	\$38.75
B2034-105	Positive Battery Cable	\$33.00
B2034-106	Switch to Starter Cable	\$33.00

Massey Harris 444 LP

B2034-107	Negative Battery Cable	\$34.50
B2034-108	Positive Battery Cable	\$35.75
B2034-109	Switch to Starter Cable	\$28.75
B2034-110	Battery to Battery Cable	\$30.75

Massey Harris 444 Diesel

B2034-111	Negative Battery Cable	\$36.50
B2034-112	Positive Battery Cable	\$81.50
B2034-113	Starter Solenoid to Heater Switch	\$54.50
B2034-114	Heater Switch to Heater Cable	\$58.75
B2034-115	Battery to Battery Cable	\$36.00



WIRING HARNESSSES

Our Wire Harnesses are made with our **premium cotton braid and/or PVC wire**.

They have the **correct gauge, color, wire, & fuse holders** (if needed).

All terminals are **soldered according to the original**.

(Harnesses do not include Batatery Cables & Spark Plug Wires; however, we can supply these as separate products.)

NO HIDDEN COSTS, NOTHING EXTRA TO BUY!

Massey Harris 4 Wheel Drive GP

B3034-001	Complete Wire Harness	\$76.25
------------------	-----------------------	----------------

Massey Harris 11 Pony

Complete Wire Harness

B3034-002	Early with Cutout Relay	\$186.50
B3034-003	Late with Regulator	\$186.50

Massey Harris 16 Pacer

B3034-004	Complete Wire Harness	\$180.25
------------------	-----------------------	-----------------

Massey Harris 20

B3034-005	Complete Wire Harness	\$151.50
------------------	-----------------------	-----------------

Massey Harris 21 Colt

B3034-006	Complete Wire Harness		\$151.50
------------------	------------------------------	--	-----------------

Massey Harris 22

Complete Wire Harness

B3034-005	Early	Up to Serial #22GR5629, Up to Serial #22GS1664, Up to Serial #22KR9857, Up to Serial #22KS1706	\$151.50
B3034-006	Late	Serial #22GR5630 & Up, Serial #22GS1665 & Up, Serial #22KR9858 & Up, Serial #22KS1707 & Up	\$151.50

Massey Harris 23 Mustang

B3034-006	Complete Wire Harness		\$151.50
------------------	------------------------------	--	-----------------

Massey Harris 30

Complete Wire Harness

B3034-010	Early with Cutout Relay	Replaces: #15146A, 21448A, 14918A	\$159.75
B3034-011	Late with Voltage Regulator		\$159.75
B3034-047	Late with Voltage Regulator, Modified for 1 Wire Alternator		\$159.75

Massey Harris 33 Gas

Complete Wire Harness

B3034-012	Original Design		\$165.75
B3034-039	Modified for 1 Wire Alternator		\$165.75

Massey Harris 33 Diesel

B3034-013	Complete Wire Harness With Regulator on Generator		\$165.75
------------------	--	--	-----------------

Massey Harris 44 Gas

Complete Wire Harness

B3034-014	Early with Regulator Under Fuel Tank	Up to Serial #44GS16142; 44GR28634, 44KS6606, 44KR3983, 44GRA1016	\$165.75
B3034-042	Modified for a 1 Wire Alternator	Up to Serial #44GS16142; 44GR28634, 44KS6606, 44KR3983, 44GRA1016	\$165.75
B3034-045	Modified for a 10SI (3 Wire Alternator	Up to Serial #44GS16142; 44GR28634, 44KS6606, 44KR3983, 44GRA1016	\$165.75
B3034-015	Late with Regulator on Generator	Serial #44GS16143 & Up, 44GR28635 & Up, 44KS6607 & Up, 44KR3984 & Up, 44GSA1001 & Up, 44GRA1016 & Up	\$165.75
B3034-046	Late, Modified for a 10SI Alternator	Per B3034-015 above	\$165.75

Massey Harris 44 Gas Special

B3034-016	Complete Wire Harness	(Serial #50001 & Up)	\$173.00
------------------	------------------------------	----------------------	-----------------

Massey Harris 44-6

B3034-017	Complete Wire Harness		\$165.75
------------------	------------------------------	--	-----------------

Massey Harris 44 Diesel

Complete Wire Harness

B3034-018	Early with Regulator Under Fuel Tank	Up to Serial #44DR4141, & Up to Serial #44DS55182	\$165.75
B3034-019	Late with Regulator on Generator	Serial #44DR44141 to 44DR45742	\$165.75
B3034-020	Late with Regulator on Generator	Serial #44DR743 & Up, Also Serial #44DS55182 & Up	\$165.75

Massey Harris 50

Complete Wire Harness

B3033-004	Original Design		\$193.75
B3033-013	Modified for 1 Wire Alternator		\$193.75
B3033-019	Modified for Delco 10SI Alternator		\$193.75

Massey Harris 55 Gas

Complete Wire Harness

B3034-022	Early, with Regulator Under Fuel Tank		\$173.00
B3034-023	Late, with Regulator on Generator		\$173.00

Massey Harris 55 Diesel

Complete Wire Harness

B3034-048	Early, with Regulator Under Fuel Tank	(Up to Serial #55DS2558, 55DSH1336, and 55DSW1665)	\$186.50
B3034-038	Late, with Regulator on Generator	(Serial #55DS2558, 55DSH1336, 55DSW1665 & Up)	\$186.50
B3034-049	Late, Modified for a 1-Wire Alternator	(Serial #55DS2558, 55DSH1336, 55DSW1665 & Up)	\$186.50

Massey Harris 81, 82

B3034-005	Complete Wire Harness		\$151.50
------------------	-----------------------	--	-----------------

Massey Harris 101 Junior

Complete Wire Harness

B3034-026	Original Design		\$173.00
B3034-041	Modified for 1 Wire Alternator		\$173.00

Massey Harris 101 Senior

Complete Wire Harness

B3034-028	Original Design		\$173.00
B3034-043	Modified for 1 Wire Alternator		\$173.00

Massey Harris 101 Super (Early with Starter Rod)

B3034-044	Complete Wire Harness		\$173.00
------------------	-----------------------	--	-----------------

Massey Harris 101 Super (Late with Starter Button)

B3034-029	Complete Wire Harness		\$173.00
------------------	-----------------------	--	-----------------

Massey Harris 102 Junior

Complete Wire Harness

B3034-026	Original Design		\$173.00
B3034-041	Modified for 1 Wire Alternator		\$173.00

Massey Harris 102 Senior

Complete Wire Harness

B3034-028	Original Design		\$173.00
B3034-043	Modified for 1 Wire Alternator		\$173.00

Massey Harris 202

B3034-031	Complete Wire Harness		\$173.00
------------------	-----------------------	--	-----------------

Massey Harris 203

B3034-032	Complete Wire Harness		\$173.00
------------------	-----------------------	--	-----------------

Massey Harris 333 Gas

B3034-033	Complete Wire Harness		\$183.25
------------------	-----------------------	--	-----------------

Massey Harris 333 Diesel

B3034-034	Complete Wire Harness		\$183.25
------------------	-----------------------	--	-----------------

Massey Harris 444 Gas

B3034-033	Complete Wire Harness		\$183.25
------------------	-----------------------	--	-----------------

Massey Harris 444 Diesel

B3034-036	Complete Wire Harness		\$183.25
------------------	-----------------------	--	-----------------

Massey Harris 555 Gas & LP

B3034-037	Complete Wire Harness		\$186.50
------------------	-----------------------	--	-----------------

Massey Harris 555 Diesel

Complete Wire Harness

B3034-038	Late, with Regulator on Generator	(Serial #55DS2558, 55DSH1336, 55DSW1665 & Up)	\$186.50
B3034-049	Late, Modified for a 1-Wire Alternator	(Serial #55DS2558, 55DSH1336, 55DSW1665 & Up)	\$186.50

Massey Harris #37 Mounted Plow

B3034-040	Complete Wire Harness		\$61.75
------------------	-----------------------	--	----------------

Note When ordering, please specify **Year** or **Serial Number**, Magneto/Distributor, & Regulator/Cut Out Relay.
Some Harnesses were originally made with PVC Wire & Braided; others were made with PVC Wire & Taped.
In those cases, we build them the **Original Way**.

TUNE UP PARTS FOR BATTERY IGNITION

Massey Harris 11 Pony, 16 Pacer, 21 Colt, 22, 23 Mustang, 30, 33, 44, 55, 81. 82, 101 JR (Late), 102 JR (Late), 333, 444, 555

	B4001-005	\$9.75
	Points Replaces: #1-4, 1-8, 1-9, 1-20, 1-22, 1-45, IAD-3128S, IGP-3028ES, IGP3028FS, IGS2224L, IGW3028AS	
	B4002-006	\$7.50
	Condenser Replaces: #2-31, 2-38, 2-42, 2-95, IAT-1125S, IAT-3076BS, IBB-2042SS-1, IBB-2042-SS3, IG-3927F, IG-3927G, IG-3927K, IG-3927R,	
	B4004-003	\$5.25
	Rotor Premium Grade, Made in USA Replaces: #4-10	
	B4003-003	\$21.00
	Distributor Cap Made in the USA (Brass Contacts) Replaces: #IG-1324D, 3-11, 3-12	

*For 6- or 12-Volt Ignition Coils & Accessories, see p.44

Massey Harris 4 Cyl. 101JR, 101SR, 203 with Autolite IGZ Distributor

	B4001-002	\$14.75
	Points Replaces: #IGW-3028S, 1-31	

	B4002-005	\$9.75
	Condenser Replaces: #2-24, 2-35, 2-22, 2-23	

*For 6-Volt Ignition Coils & Accessories, see p.44

Massey Harris 50

	B4100-001	\$10.50
	PCR Kit Includes: Points (#B4001-001), Condenser (#B4002-001), Rotor (#B4004-002) Replaces: Points - #D100HP, 1855720 Condenser - #1928111, D-203, 1869704, D-200 Rotor - #820445, D400	
	B4004-002	\$5.75
	Rotor Replaces: #820445, D400	
	B4003-001	\$13.50
	Distributor Cap Premium Grade, Made in the USA (Brass Contacts) Replaces: #811735, D300	
	B4006-001	\$9.99
	Dust Cover Replaces: #1900119	
	B4007-001	\$11.95
	Cap Clip Short Mount, 1 Used Replaces: #1889967, 1847289, 453844, 453461	

	B4007-002 Cap Clip Long Mount, 1 Used Replaces: #1889967, 1889999, 453844, 453461	\$11.95
	B4008-001 Distributor Insulator Replaces: #1904376	\$14.99
	B4009-001 Distributor Bushing & Shim Kit	\$25.99

*For 6- or 12-Volt Ignition Coils & Accessories, see p.44



Massey Harris

with Autolite Distributors IGC-4506 & IGC-4506-1
44-6 with Autolite Distributor #IAD-4027, IAD-6002

	B4001-005 Points Replaces: #1-4, 1-8, 1-9, 1-20, 1-22, 1-45, IAD-3128S, IGP-3028ES, IGP3028FS, IGS2224L, IGW3028AS	\$9.75
	B4002-006 Condenser Replaces: #2-31, 2-38, 2-42, 2-95, IAT-1125S, IAT-3076BS, IBB-2042SS-1, IBB-2042-SS3, IG-3927F, IG-3927G, IG-3927K, IG-3927R,	\$7.50
	B4004-007 Rotor Premium Grade, Made in the USA Replaces: #4-19	\$8.25
	B4003-007 Distributor Cap Premium Grade, Made in the USA (Brass Contacts) Replaces: #IGC-1107S, 3-23	\$25.00

Massey Harris 6 Cyl. 44-6, 102 SR

with Autolite Distributor #IGZ

	B4001-002 Points Replaces: #IGW-3028S, 1-31	\$14.75
	B4002-005 Condenser Replaces: #2-24, 2-35, 2-22, 2-23	\$9.75

(Cap & Rotor may be available too)

*For 6-Volt Ignition Coils & Accessories, see p.44

ELECTRONIC IGNITION
CONVERSION KITS

Replaces Points & Condenser



Massey Harris 11 Pony, 16 Pacer, 21 Colt, 22, 23 Mustang, 30, 33, 44, 55, 81, 82, 101 JR (Late), 102 JR (Late), 333, 444, 555

B9600-057	12 Volt Negative Ground	\$129.95
B9600-057P12	12 Volt Positive Ground	\$147.45
B9600-057N6	6 Volt Negative Ground	\$147.45
B9600-057P6	6 Volt Positive Ground	\$147.45

Massey Harris 44-6 with Autolite Distributor #IAD-6002

B9600-064	12 Volt Negative Ground	\$134.45
------------------	-------------------------	-----------------

Massey Harris 50



B9600-006	12 Volt Negative Ground	\$147.45
B9600-006P12	12 Volt Positive Ground	\$165.45



For Ignition Coils & Accessories, see p.44

TUNE UP PARTS FOR
MAGNETO IGNITION

Massey Harris Challenger, Pacemaker, Wallis, 12-20, 20-30, 25 with WICO Magneto #XH184, 1023

	B4011-004 Points Replaces: #1-5008, 1-5111, FXH-2100B, FXH-2400B, X5996	\$17.75
	B4012-002 Condenser Replaces: #2-5007, X5614, X6916	\$13.75

	B4017-040 Condenser Clamp Replaces: #94-5167	\$2.75
	B4013-004 Cap Includes #B4016-004 Replaces: #3-5014	\$36.75
	B4014-002 Rotor Replaces: #4-5010	\$23.50
	B4016-004 Cap Gasket Replaces: #94-5076	\$2.25
	B4015-003 Coil (Hot Coil) Replaces: #5-5011, AR12006, FXH2403, X5700, X5700B, X5700C	\$39.75
	B4017-003 Coil Clamp 2 used, each sold separately Replaces: #94-5080	\$2.25
	B4017-004 Coil Bar Replaces: #94-5066	\$8.50
	B4017-005 Inner Bearing Replaces: #24-5000	\$3.50
	B4017-006 Outer Bearing Replaces: #25-5000	\$9.75
	B4017-046 Bearing Cage Snap Ring Replaces: #43-5055	\$2.75
	B4017-007 Impulse Spring Replaces: #94-5016	\$12.50

	B4017-008 Stop Button Assembly Includes #B4017-009 Replaces: #90-5042 For the version with a Ground Wire, use #B4017-063 (\$7.26) instead.	\$6.25
	B4017-051 WICO Impulse Catch Plate Replaces: #94-5070, FXH-210S-1	\$10.25
	B4017-009 Stop Button Replaces: #94-5079	\$2.25
	B4016-005 Flange Gasket Replaces: #SAE	\$1.75
	B4016-012 Striker Plate Gasket Replaces: #94-5154	\$2.25
	B9013-011 WICO Series X Nameplate Fits the WICO Series X magneto (Rivets included)	\$7.00



Massey Harris

with Fairbanks Morse Magneto #FMX-E4B5A

	B4011-003 Points Replaces: #A2437A	\$18.50
	B4012-004 Condenser Replaces: #SXY2433	\$11.00
	B4014-014 Rotor Replaces: #X2765	\$25.00
	B4015-002 Coil Replaces: #R2477C	\$39.75
	B4017-039 Distributor Shaft Bearing Replaces: #D5950C	\$6.75
	B4017-002 Rear Ball Bearing Replaces: #C5949	\$11.75

GAUGES



Ammeters

B9025-002	Ammeter 20-0-20	\$19.99
	Has a black face with white lettering and a chrome bezel Does not have a logo Dimensions: Fits in 2" Diameter Hole 1.850" From Post to Bottom of Bezel	
B9025-005	Ammeter 30-0-30	\$19.99
	This Gauge has a chrome bezel. Massey Harris Fits: 101 Jr, 101 Sr, 102 Jr, 102 Sr, 44 Special, 44-6, Colt (21), Mustang (23), Pacer (16), Pony (11 & 14), 20, 22, 30, 33, 44, 50, 55, 81, 82, 201, 202, 203, 333, 404, 444, 555	
B9025-008	Ammeter 60-0-60	\$19.99
	Has a black face with white lettering & a chrome bezel Uses threaded terminals and is dash mounted Used with 12-Volt Alternator Systems Dimensions: Fits in 2" Diameter Hole Measures 1.765" from Top of Post to Bottom of Bezel	



Oil Pressure Gauges

B9025-004	Universal Oil Pressure Gauge (0-50 PSI)	\$21.99
	Has 1/8" NPT MALE THREADS, studs & a bracket. No logo included on this Gauge. Dash-mounted, requires a 2" diameter hole. Massey Harris Fits: 101 Jr, 101 Sr, 102 Jr, 102 Sr, 20K, 22K, 30K, 44 Special, 44-6, 44K, 55K, Colt (21), Mustang (23), Pacer (16), Pony, 20, 22, 30, 33, 44, 50, 55, 81, 82, 201, 202, 203, 303, 333, 404, 444, 555, 1001	
B9025-001	Universal Oil Pressure Gauge (0-80 PSI)	\$24.99
	Has 1/8" NPT MALE THREADS, studs & a bracket. No logo included on this Gauge. Dash-mounted, requires a 2" diameter hole. Massey Harris Fits: 101 Jr, 101 Sr, 102 Jr, 102 Sr, 44 Special, 44-6, Colt (21), I-244, I-330, Mustang (23), Pacer (16), Pony, 20, 22, 30, 33, 44, 50, 55, 81, 82, 201, 202, 203, 303, 333, 404, 444, 555 (& others using 80 Lb. Gauge) Replaces: 761511M91	

Oil Pressure Gauge, Line Kit

B9026-001	Oil Pressure Gauge Line Kit	\$29.99
	6 FT copper 1/8" line --- Kit includes: (2) 5/16 - 24 UNF nut, (2) compression sleeves, (1) 1/8 - 27 NPTF female to 5/16" - 24 UNF male adapter --- Note: Depending on application customer may be required to purchase other fittings.	
B9026-004	Oil Pressure Gauge 1/4" to 1/8" NPT Adapter Fitting	\$15.99
	Adapter Fitting for Oil Gauges - 1/4" to 1/8" NPT. Massey Harris Fits: Mustang (23), Pacer (16), Pony, 101 Jr, 101 Sr, 102 Jr, 102 Sr, 20, 201, 202, 203, 22, 30, 33, 333, 44, 444, 50, 55, 555	

Water Temperature Gauges, Universal

B9025-006	Water Temperature Gauge	\$34.99
	Includes an Aluminum Sealing Washer to Seal Probe. It has a Chrome Bezel with White, Green, Red Zones on a Black Gauge Face. Has a 1/2" NPT Pipe Bushing and Probe Length of 1.279". Massey Harris Fits: Colt (21), I-162, I-244, I-330, Mustang (23), Pacemaker, Pacer (16), Pony, 101 Jr, 101 Sr, 102 Jr, 102 Sr, 20, 201, 202, 203, 20K, 22, 22K, 30, 303, 30K, 33, 333, 404, 44, 44-6, 444, 44K, 44 Special, 50, 55, 555, 55K, 81, 82, (And Other Models Using 60" Capillary Lead)	
B9025-007	Universal, Water Temperature Gauge	\$34.99
	Dash-mounted (parts included), 72" long heavy duty capillary tube included (check length before ordering) Massey Harris Replaces: 21475A Fits: [Colt (21), I-162, I-244, I-330, Mustang (23), Pacer (16), 101 Jr, 101 Sr, 102 Jr, 102 Sr, 20, 201, 202, 203, 22, 30, 303, 33, 333, 404, 44, 44-6, 444, 44 Special, 50, 55, 555, 81, 82, Pony (11 & 14), And Others Using 72" Or Shorter Capillary Lead	

Tachometer Drives

B9035-001	Tachometer Drive Assembly	\$46.50
	Has a 14 Tooth to 43 Tooth Gear Ratio. Includes Gaskets. Massey Harris Fits: TO-20, TO-30, TO-35 (Continental Gas / LP), Ferguson: 50 (Continental Gas / LP)	

Tachometer Drive Cable

B9026-008	38 7/8" Tachometer Drive Cable	\$20.99
	Measures 38 7/8" long with a metal sheath. Has square ends with 5/8" – 18 x 7/8" – 18 threads. Massey Harris Fits: 50 (4 cyl. Gas/LP)	

SWITCHES

B5011-002	Light Switch Resistor	\$15.99
	Used on all Models with Cut Out Relay & Original Delco 4 Position Light Switch Fits: Massey Harris -101 Jr, 101 Sr, 102 Jr, 102 Sr, 20K, 30K, 20, 30, 81, 82 Replaces: Delco -#1838155, 1882994, 1878070 Massey Harris - #1000072M1	

Push/Pull Switches

B5002-001	2 Position Push/Pull Switch	\$7.75
	OFF/ON Universal 2 Position Push/Pull (2 <i>Screw Terminals</i>) Mounting Stem 3/8"-32 Thread Knob #10/32 Thread	

B5002-005	3-Position Push/ Pull Switch	\$29.75
	Low Charge/High Charge/Lights (3 Position Switch) 3 <i>Screw Type</i> Mounting Stem .8" Thread Knob #10/32 Thread Premium Quality Made by the OEM Manufacturer	

B5002-004	Heavy Duty Push/Pull Magneto Switch	\$8.25
	ON/OFF (2 Position) Push/Pull Magneto Switch (2 <i>Screw Terminals</i>) Mounting Stem 3/8"-32 Thread Knob #10/32 Thread	

Key Switches

B5003-001	2 Position Battery Key Switch	\$14.75
	Universal OFF/ON 2 Position Key Switch (For Battery Ignition) (2 <i>Screw Terminals</i>) Mounting Stem 3/4"-20 Thread	

B5003-004	4 Position Battery Key Switch	\$22.99
	OFF/IGN/IGN Lights/Lights (4 Position) Key Switch (3 <i>Screw Terminals</i>) Mounting Stem 5/8"-32 Thread Massey Harris Replaces: #851846M1 Fits: 50, Pacer (16), Pony (1953 and up)	

B5003-008	Ignition Key Switch	\$24.99
	Includes 2 Keys, 2 Spade Terminals, Designed for 0.800" hole diameter. Massey Harris Replaces: #764929M91, 14491A Fits: 20, 22, 30, 33, 44, 50, 55, 81, 82, 101 Jr, 101 Sr, 102 Jr, 102 Sr, 44-6, Colt (21), Mustang (23), Pony,	

Momentary Switches

B5004-003	Momentary Push Switch	\$15.75
	Manual Push Button Solenoid Switch with Rubber Protected Cap (2 <i>Screw Terminals</i>) Mounting Stem 5/8"-32 Thread Massey Harris Replaces: 767828M91 Fits: 50 (Starter or Ether Switch), [333, 444, 555 (Starter Switch)], [Workbull: 304, 404 (Starter Switch)]	

B5004-008	Neutral Safety Switch	\$15.49
	Massey Harris Fits: 50	

B5004-009	Neutral Safety Switch Boot	\$11.99
	Fits 1.000" Dia. Switch, 1.125" Deep, 0.140" Wire hole diameter. Massey Harris Fits: 50	

STARTER SWITCHES (MECHANICAL)

B5006-001	Starter Switch (Long Shaft)	\$12.75
	6 or 12 Volt Panel Mounted Manual Push Start Switch Replaces: Massey Ferguson - #1816-79-M1, RO1327, Massey Harris - #1816-79-M1, RO1327 Fits: Massey Harris - 20, 21, 22, 23, 30, 33, 44, 44-6 55, 81, 82, 101 JR, 102 JR, 101 SR, 102 SR, 202, 203 333, 444, 555 Also Used As Manifold Heater Switch On 333, 444 Diesel	

B5007-001	6 Volt Starter Solenoid	\$17.50
	3 Terminal Solenoid with Curved Bracket Fits: Massey Harris - 11/Pony, 16/Pacer, 50	
B5004-001	Momentary Push Switch	\$14.00
	Manual Push Button Solenoid Switch 2 Screw Terminals Mounting Stem 5/8"-32 Thread Massey Harris Fits: 11 (Pony), 16 (Pacer MH50)	
B5007-003	12 Volt Solenoid	\$17.50
	3 Terminal Solenoid With Flat Bracket Massey Harris Fits: 40, 333 Gas, 444 Gas	

CUTOUT RELAYS & VOLTAGE REGULATORS

Note: Due to modern battery design, voltage regulators can't be used to charge low or dead batteries. Doing so will destroy the voltage regulator and void the warranty.

B8001-001	6-Volt Cutout Relay	\$19.50
	15 Amps, 6 Volt Works Positive or Negative Ground Replaces: Autolite - #CB4014, C4012 (9-5), C4012 (9-4), C4012 (9-1), R40061 Massey Ferguson - #1500199M91 Delco - #266P, 266N, 265P, 265N, 5015850, 812970, 265J, 820845, 812971, 1116816, 265G, 265H, 1116755, 1116751, 1116809DR, 265B, 1842859, 265C, 1867781, 265F, 265D Fits: Massey Harris (w/ Cutout) - 101 Jr, 101 Sr, 102 Jr, 102 Sr, 20K, 22K, 30K, Pacer (16), 11 (Pony) (Thru 1951 Using GBM-4804A-5 Generator), 20, 22, 30, 44 (6 cyl), 81, 82	
B8001-002	Electronic Cutout Relay	\$19.50
	25 Amp, Works with 6, 12, or 24 Volts. & Positive or Negative Ground Replaces: Autolite - #CB4014, C4012(9-5), C4012(9-4), C4012(9-1), R40061 Delco - #266P, 266N, 265P, 265N, 5015850, 812970, 265J, 820845, 812971, 1116816, 265G, 265H, 1116755, 1116751, 1116809DR, 265B, 1842859, 265C, 1867781, 265F, 265D Massey Ferguson - #1500199M91 Fits: Massey Harris (with Cutout) - 101 Jr, 101 Sr, 102 Jr, 102 Sr, 20K, 22K, 30K, Pacer (16), 11 (Pony) (Thru 1951 Using GBM-4804A-5 Generator), 20, 22, 30, 44 (6 cyl), 81, 82	

6-Volt Saddle Mounted Cutout Relay (Delco Version)		
B8001-004	Premium Quality, Made in the USA	\$122.50
B8001-006	Standard Quality	\$38.59
	Cutout Relay, 25 Amp, 6 Volt, Works Positive or Negative Ground. Replaces: Delco - #266P, 266N, 265P, 265N, 5015850, 812970, 265J, 820845, 812971, 1116816, 265G, 265H, 1116755, 1116751, 1116809DR, 265B, 1842859, 265C, 1867781, 265F, 265D Massey Ferguson - #1500199M91 Fits: Massey Harris (with Cutout) - 101 Jr, 101 Sr, 102 Jr, 102 Sr, 20K, 22K, 30K, Pacer (16), 11 (Pony) (Thru 1951 Using GBM-4804A-5 Generator), 20, 22, 30, 44 (6 cyl), 81, 82	

6-Volt Delco Type Voltage Regulator		
B8002-025	Premium Quality, Made in the USA	\$118.25
B8002-046	Standard Quality	\$34.75
	Functional Replacement For Original Autolite Regulator 6 Volt, 3 Terminals, Curved Mounting Bracket Regulator, <i>Generator Mounted</i> Replaces: Delco - #1118786, 1972234, A617M Prestolite - #GRX-406, GRX-407 Fits: Massey Harris - (Generator Mounted Regulator) 11 Pony, 16 Pacer, 21 Colt, 22, 23, Mustang, 30, 30k, 33, (44 All Except GJP Series Generator), 44D (Late), 44-6, (55 All Except GGP Series Generator), 55D (Late), (303, With GHH-6003A Generator)	

B8002-028	6-Volt Autolite Type Voltage Regulator	\$158.60
	6 Volt, 3 Terminal, Flat Mounting Bracket Regulator (Premium Quality Made in the USA) Replaces: Prestolite - #8-117, 8-70, 8-74, GRX-761, VBE-6102A, VBE-6104A, VBO-4601F, VBO-4601K, VBO-4602B, VBO-4602R, VRB-4002C, VRP-4001A, VRP-4001B, VRP-4002D, VRP-4003A, VRP-4003B, VRP-4004A, VRP-4004C, VRP-4004F, VRP-4008A, VRP-6001A, VRP-6001B, VRP-6002A, VRP-6005A, VRP-6101A, VRP-6101B Chrysler - #1120515, 1121978, 1257394, 1321757, 1343573, 1571161, 2095209, 871763 Fits: Massey Harris - (6 Volt, Early Tractor Mounted Under Fuel Tank) 44, (Early) 55, (Early)	

B8002-008	12-Volt Autolite Type Voltage Regulator	\$69.75
	12 Volt, 3 Terminal, Flat Mounting (Premium Quality, Made in the USA) Replaces: Prestolite - #8-59, VBO-4202B, VRS4201AX Fits: Massey Harris - (12-Volt, Early Tractor-Mounted Under Fuel Tank) 44D, (Early), 55D, (Early)	

12-Volt Delco Type Voltage Regulator		
B8002-015	Premium Quality, USA Made	\$108.50
B8002-016	Standard Quality	\$34.75
 <p>Functional Replacement For Original Autolite Regulator 12 Volt, 4 Terminals, Curved Mounting Bracket/ Generator Mounted, Positive or Negative Ground Replaces: Delco - #1118266, 1118306, 1118791, 1118983, 1118985, D644, D648 Massey Harris - 333, 444, 555, 444 (With Generator #GHH-6003A)</p>		

12-Volt Delco Type Voltage Regulator		
B8002-017	Premium Quality, Made in the USA	\$99.75
B8002-018	Standard Quality	\$34.75
 <p>12 Volt, 4 Terminals, Flat Mounting Bracket Regulator <i>Tractor Mounted</i> Fits: Massey Harris - MH50 Replaces: Delco - #1118381, 1118779, 1118977, 1118987, 1118993, 1118997, 1118999, 1119576, D646 Prestolite - #8-290</p>		

BRUSH SETS

X324	12 Volt, 3 Brush Generator Set	\$8.25
 <p>Consisting of 3 Brushes <i>Generator Mounted</i> Massey Harris Fits: 11 PONY, 16 PACER, 21 COLT, 22, 23, MUSTANG, 30, 30K, 33, (44 All Except GJP Series, Generator), 44D (LATE), 44-6, (55 All Except GGP Series Generator), 55D (LATE), (303, With GHH-6003A Generator), 444 (With Generator #GHH-6003A)</p>		

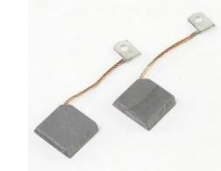
X270	12 Volt, 2 Brush Generator Set	\$5.00
 <p>Consisting of 2 Brushes <i>Generator Mounted</i> Massey Harris Fits: 333, 444, 555</p>		

X348	12 Volt, 3 Brush Generator Set	\$6.00
 <p>Consisting of 3 Brushes <i>Tractor Mounted</i> Massey Harris Fits: MH50</p>		

IDENTIFICATION TAGS

B9013-001	Small Autolite I.D. Tag (Blank)	\$7.00
	Small Autolite I.D. Tag (Stamped)	\$14.25
		2 5/16" Long, Black I.D. Tag for Distributors, Starters, & Generators with Rivets
B9013-002	Large Autolite I.D. Tag (Blank)	\$7.00
	Large Autolite I.D. Tag (Stamped)	\$14.25
		2 15/16" Long, Black I.D. Tag for Distributors, Starters, & Generators with Rivets
B9013-004	Delco Remy I.D. Tag (Blank)	\$7.00
	Delco Remy I.D. Tag (Stamped)	\$14.25
		Black Delco-Remy I.D. Tag for Distributors, 6 Volt Starters, & 6 Volt Generators with Rivets, 3/4" 2 5/16"
B9013-005	Red Delco Remy I.D. Tag (Blank)	\$7.00
	Red Delco Remy I.D. Tag (Stamped)	\$14.25
		Red Delco-Remy I.D. Tag for 12 Volt Starters & 12 Volt Generators with Rivets, 3/4" 2 5/16"
B9013-014	Blank Engine Serial Number Tag	\$32.99
		Massey-Harris Ferguson Serial Number Tag (Size 3 5/16" x 1 15/16") Fits: Massey Harris , 50 Series/ Massey Ferguson , 40, TO-35, 50, 202, 204, 2135, 135, 35

ALTERNATORS

Delco 10SI Type



B6001-005	6 Volt Alternator (1 Wire, Positive Ground)	\$166.50
6 Volt, 40 Amp Alternator with Positive Ground, 1 Wire, 3/8" pulley		
B6001-013	12 Volt Alternator (1 Wire), 5/8" to 3/4" Pulley	\$113.75
12-Volt, 1-Wire Alternator (Self-Exciting), 63 Amp, Negative Ground, 5/8" to 3/4" Pulley		

Small ND Type

B6002-003	12 Volt Small Denso Alternator (1 Wire)	\$119.75
	<p>This 40 Amp, 1 Wire Internal Regulator Alternator will Start Charging with a Much Lower Engine Speed Than Most Other Alternators! Comes with a 4 1/2" Housing Diameter, 3/8 To 1/2" Belt width & a 2 1/2" Pulley Diameter. Perfect for the Machine That Requires a Smaller Alternator.</p> <p>Excellent for Converting a 6 Volt System to 12 Volt. Available as Negative Ground Only & is Self-Excited</p>	

LIGHTS & LIGHT PARTS

Headlight Assembly		
B9016-040	Bullet Type 6 Volt Head	\$53.99
B9016-041	Bullet Type 12 Volt Head	\$53.99
	<p>Massey Harris Fits: 21 COLT, 23 MUSTANG, 333, 444, 555</p>	

PARTS FOR LIGHT ABOVE

B9017-056	4 3/4" Lens with Guide Name	\$14.99
B9017-057	4 3/4" Clamp Ring (Black)	\$15.99
B9017-058	4 3/4" Gasket	\$3.99
B9017-004	4 3/4" Reflector	\$14.99
B9017-067	4 3/4" Light Terminal	\$6.00
B9017-013	6 Volt Bulb	\$3.00
	Pack of 10	\$25.50
B9017-015	12 Volt Bulb	\$3.00
	Pack of 10	\$25.50

B9016-062	12V Headlight Assembly	\$49.99
	<p>12 Volt 5 3/4" Headlight. Stamped: TRACT-O-LITE on housing. Massey Harris Fits: 50 (Serviceable, w/ hood mounted lights)</p>	

PARTS FOR LIGHT ABOVE

B9017-033	Sealed Beam, 12 Volt Bulb	\$14.75
	<p>Double Contact High Beam 35 Watts with a 5.625" Outside Diameter Replaces bulb #4419</p>	

DASH LAMPS

B9016-013	Chrome Finish Dash Lamp	\$19.75
	<p>6 or 12 Volt, <u>Bulb Not Included.</u> 6 Volt: Use Bulb #B9017-046 12 Volt: Use Bulb #B9017-049 Massey Harris Replaces: 762269M91, 763868M91 Fits: Mustang (23), 33, 44, 55, 333, 444, 555</p>	
B9016-014	Black Finish Dash Lamp	\$19.75
	<p>6 or 12 Volt, <u>Bulb Not Included.</u> 6 Volt: Use Bulb #B9017-046 12 Volt: Use Bulb #B9017-049 Massey Harris Replaces: 762269M91, 763868M91 Fits: Mustang (23), 33, 44, 55, 333, 444, 555</p>	

Light Bulbs

B9017-046	6 Volt Bulb	\$1.25
B9017-049	12 Volt Bulb	\$1.25
	<p>Light bulbs for products #B9016-013, #B9016-014</p>	

AUXILIARY PLUG & SOCKET

B9032-001	2 Pole Auxiliary Plug	\$23.75
	<p>Replaces: Massey Ferguson - #763868M91 Fits: Massey Harris - Mustang (23), 33, 44, 55, 333, 444, 555</p>	
B9032-002	2 Pole Auxiliary Connector	\$19.75
	<p>(Used With B9032-001) Replaces: Massey Ferguson - #763868M91 Fits: Massey Harris - Mustang (23), 33, 44, 55, 333, 444, 555</p>	

CIGARETTE LIGHTERS

B9030-001	6 Volt Cigarette Lighter	\$29.99
	<p>With Anodized Aluminum Knob, "Lighter" Is Engraved Replaces: Massey Harris - #765434M91 Fits: Massey Harris - [44 Special, 44-6, 44, 55 (gas, with 6 Volt systems)]</p>	

B9030-002	12 Volt Cigarette Lighter	\$29.99
	With Anodized Aluminum Knob Engraved with the word Lighter Replaces: Massey Harris - #765433M91 Fits: Massey Ferguson - 95, 97 Massey Harris - 44 Special (Diesel), 303, 333, 404, 444, 555	

B9030-003	12 Volt Cigarette Lighter	\$27.99
	The knob is black plastic with the word 'lighter' in white printing Massey Harris Replaces: - #677277 (MF) Fits: 50 (with 12-volt systems)	

DASH GROMMETS

B9033-004	Massey Harris Under Dash Grommet	\$1.50
	Under Dash Grommet for Massey Harris 30, 33, 44, 44-6, 55, 333, 444, 555 (2 Used Per Tractor)	

CARBURETOR REBUILD KITS

B9022-017	Marvel-Schebler Carburetor Rebuild Kit	\$39.75
	Massey Harris Tractors Model 11 Pony Fits Carburetor: Marvel-Schebler Carburetor #TSV-16, TSV-24	

B9022-023	Marvel Schebler Carburetor Rebuild Kit	\$24.50
	Massey Harris 101 JR, 102 JR, 20, 22, 22K, 30, 35, 40, 50, 81, 82, 21 (Colt), 23 (Mustang), 16 (Pacer) Fits Marvel-Schebler Carburetor : #1004SL, TSX101, TSX102, TSX103, TSX112, TSX113, TSX114, TSX119, TSX120, TSX126, TSX128, TSX13, TSX132, TSX132A, TSX133, TSX134, TSX136, TSX137, TSX138, TSX140, TSX141, TSX142, TSX144, TSX146, TSX147, TSX148, TSX150, TSX151, TSX154, TSX155, TSX156, TSX157, TSX159, TSX161, TSX167, TSX171, TSX173, TSX179, TSX180, TSX182, TSX183, TSX184, TSX186, TSX188, TSX189, TSX190, TSX191, TSX192, TSX193, TSX194, TSX197, TSX198, TSX202, TSX203, TSX206, TSX206-1, TSX211, TSX212, TSX225, TSX228, TSX231, TSX237, TSX239, TSX239-1, TSX240, TSX241A, TSX241B, TSX241C, TSX246, TSX248, TSX253, TSX254, TSX258, TSX260, TSX264, TSX266, TSX267, TSX269, TSX272, TSX274, TSX278, TSX28, TSX280, TSX286, TSX287, TSX288, TSX289, TSX29, TSX290, TSX297, TSX30, TSX301, TSX305, TSX306, TSX308, TSX309, TSX312, TSX314, TSX315, TSX319, TSX322, TSX323, TSX326, TSX328, TSX33, TSX330, TSX331, TSX332, TSX333, TSX334, TSX335, TSX338, TSX339, TSX34, TSX341, TSX346, TSX347, TSX348, TSX35, TSX351,	

TSX352, TSX356, TSX357, TSX358, TSX359, TSX36, TSX361, TSX361-A, TSX363, TSX366, TSX367, TSX368, TSX37, TSX370, TSX370-1, TSX377, TSX38, TSX380, TSX388, TSX389, TSX39, TSX391, TSX398, TSX400, TSX403, TSX405, TSX406, TSX407, TSX409, TSX418, TSX419, TSX42, TSX420, TSX421, TSX422, TSX423, TSX428, TSX43, TSX44, TSX443, TSX447, TSX448, TSX45, TSX450, TSX452, TSX453, TSX455, TSX458, TSX459, TSX465, TSX470, TSX472, TSX474, TSX48, TSX480, TSX481, TSX484, TSX486, TSX49, TSX497, TSX500, TSX507, TSX510, TSX513, TSX514, TSX516, TSX518, TSX520, TSX525, TSX531, TSX532, TSX534, TSX539, TSX54, TSX541, TSX55, TSX551, TSX552, TSX556, TSX558, TSX560, TSX567, TSX569, TSX570, TSX573, TSX577, TSX58, TSX580, TSX589, TSX59, TSX593, TSX595, TSX597, TSX60, TSX603, TSX605, TSX606, TSX611, TSX614, TSX618, TSX626, TSX633, TSX635, TSX643, TSX646, TSX649, TSX649-1, TSX650, TSX653, TSX655, TSX656, TSX660, TSX663, TSX665, TSX668, TSX670, TSX671, TSX676, TSX680, TSX681, TSX683, TSX69, TSX690, TSX691, TSX692, TSX694, TSX696, TSX701, TSX706, TSX709, TSX710, TSX714, TSX730, TSX736, TSX74, TSX742, TSX744, TSX748, TSX753, TSX76, TSX762, TSX765, TSX767, TSX770, TSX771, TSX776, TSX776-1, TSX78, TSX781, TSX787, TSX79, TSX793, TSX796, TSX80, TSX802, TSX803, TSX804, TSX809, TSX812, TSX815, TSX820, TSX826, TSX827, TSX83, TSX830, TSX841, TSX844, TSX85, TSX851, TSX855, TSX857, TSX860, TSX862, TSX864, TSX865, TSX866, TSX879, TSX88, TSX882, TSX89, TSX896, TSX896SL, TSX90, TSX901, TSX91, TSX912, TSX913, TSX914, TSX919, TSX926, TSX930, TSX931, TSX936, TSX936SL, TSX937, TSX937SL, TSX94, TSX948, TSX949, TSX95, TSX954, TSX957, TSX957SL, TSX95A, TSX96, TSX971, TSX976, TSX978, TSX979, TSX979-1, TSX98, TSX983, TSX986, TSX987, TSX99, TSX990, TSX991, TSX991-1, TSX996, TSXU828, TSXU829, TSXU830, TSXU831, TSXU832, TSXU833, TSXU834, 1003 Massey Harris Carburetor : #181532M91, 181643M91, 181644M91, 181740M91, 183576M91, 194065M92, 6195A, 6195A, 6307A, 6371A, 6401A, 6683A, 6684A, 6688A, 761301M91, 761304M91, 852186M1, TO9510, TO9510-1, TO-9510-B1		
---	--	--

B9022-003	Marvel-Schebler Carburetor Rebuild Kit	\$24.99
	Massey Harris Tractors Model 30, 102, 201, 202, 203 Fits Carburetor: Marvel-Schebler Carburetor : #TSX-27, TSX-27A, TSX-62, TSX-93, TSX-162, TSX-644, TSX-779, TSX-786, TSX-786- 1, TSXU-837, TSXU-838, TSXU-839, TSX-916 Massey Harris Carburetor : #6376-A, 6388-A, 6688-A, 6709-A, 184-845-M91, 186-602-M91, 186-602-M92, 770- 170-M91, 512627-M91	

B9022-005	Marvel-Schebler Carburetor Rebuild Kit	\$23.99
	Massey Harris Tractors Model 33, 333 Fits Carburetor: Marvel-Schebler Carburetor : #TSX1001, TSX1002, TSX181, TSX221, TSX245, TSX296, TSX332, TSX360, TSX374, TSX397, TSX413, TSX414, TSX436, TSX464, TSX466, TSX475, TSX492, TSX505, TSX506, TSX506A, TSX526, TSX528, TSX530, TSX561, TSX562, TSX563, TSX575, TSX582, TSX592, TSX596, TSX602, TSX605, TSX606, TSX610, TSX615, TSX633, TSX639, TSX641, TSX645, TSX648, TSX662, TSX678, TSX688, TSX689, TSX695...	

... TSX704, TSX711, TSX713, TSX719, TSX721, TSX725, TSX732, TSX737, TSX738, TSX755, TSX756, TSX757, TSX759, TSX768, TSX769, TSX772, TSX773, TSX775, TSX777, TSX784, TSX788, TSX791, TSX792, TSX797, TSX798, TSX799, TSX800, TSX801, TSX806, TSX808, TSX810, TSX811, TSX813, TSX814, TSX816, TSX819, TSX825, TSX836, TSX843, TSX849, TSX853, TSX854, TSX856, TSX857, TSX867, TSX869, TSX871, TSX877, TSX878, TSX881, TSX883, TSX884, TSX885, TSX886, TSX888, TSX889, TSX892, TSX892S, TSX893, TSX894, TSX895, TSX897, TSX898, TSX899, TSX900, TSX902, TSX903, TSX904, TSX904SL, TSX905, TSX905-1, TSX905SL, TSX906, TSX906SL, TSX907, TSX907SL, TSX908, TSX908SL, TSX911, TSX917, TSX920, TSX920SL, TSX921SL, TSX922, TSX922SL, TSX923, TSX923SL, TSX925, TSX927, TSX928, TSX932, TSX932SL, TSX933, TSX934, TSX934SL, TSX938, TSX938SL, TSX939, TSX940, TSX940SL, TSX941, TSX941SL, TSX942, TSX943, TSX944SL, TSX945SL, TSX946, TSX947SL, TSX949, TSX950, TSX952, TSX952SL, TSX955, TSX959, TSX959SL, TSX961, TSX961SL, TSX962, TSX962SL, TSX964SL, TSX965SL, TSX966, TSX967SL, TSX968SL, TSX97, TSX972, TSX973, TSX974, TSX974SL, TSX975, TSX975SL, TSX977, TSX980, TSX980SL, TSX984SL, TSX985, TSX985SL, TSX988, TSX989, TSX993, TSX994, TSX997, TSX998, TSX999, TSXU1006, TSXU1007, TSXU835, TSXU836, TSXU840, TSXU904, TSXU904SL, TSXU905, TSXU905-1, TSXU944SL, TSXU963, TSXU9631, TSXU995

Massey Harris Carburetor: #184-301-M92, 190-383-M91, 190-383-M92, 191-494-M91, 520-736-M91, 764-920-M91, 766-576-M91, 768-190-M91, 768-191-M91770-079-M91

B9022-009	Zenith Carburetor Rebuild Kit	\$27.99
 <p>Massey Harris Tractors Model 44, 44H, 44K, 44-6, 444, 55, 55K, 55KS, Challenger, Pacemaker Fits Carburetor: Zenith Carburetor #S1214, 8503, 10279, 10285, 10444, 10445, 11523, 11524, 11622, 11629, 11644, 11979, 14644 Massey Harris Carburetor: #6068-A, 6809, 6810-A, 6826, 761-504-M91, 761-544-M91, 765-218-M91, 765-219-M91, 768-219-M91, 768-476-M91, 768-496-M91</p>		

B9022-028	Marvel-Schebler Carburetor TRX Rebuild Kit	\$37.99
<p>Massey Harris Tractors (with Marvel Schebler TRX22, 27, 29, 30, 31, 36, 49) – 44-6, 101 Sr) Marvel-Schebler Carburetor: #TRX12, TRX22, TRX27, TRX29, TRX30, TRX31, TRX36, TRX49 Massey Harris Carburetor: #6664A</p>		

CARBURETOR FLOATS



B9023-002	Marvel-Schebler Carburetor Float	\$26.99
 <p>Massey Harris Tractors Model 11, Pony Fits Carburetor: Marvel-Schebler Carburetor #TSV13, TSV15, TSV16, TSV17, TSV18, TSV21, TSV22, TSV24, TSV27, TSV35, TSV37, TSV45, TSV47, TSV48, TSV49, TSV50, TSV52, TSV53, TSV54 Replaces: Massey Harris: #1500139M91, 850312M1, 850312M2 Marvel Schebler: #30-667</p>		

B9023-003	Marvel-Schebler Carburetor Float	\$12.75
 <p>Massey Harris Tractors Model 16, 20, 21, 30, 35, 40, 50, 81, 82, 101J, 102JR, 201, 202 Fits Carburetor: Marvel-Schebler Carburetor: #TSX27A, TSX-28, TSX-34, TSX-55, TSX-88, TSX-155, TSX-188, TSX228, TSX-248, TSX-272, TSX-308, TSX-309, TSX-312, TSX-361, TSX-361A, TSX-458, TSX-541, TSX-605, TSX-683, TSX-882, TSXU-831, TSXU-832, TSXU-834 Massey Ferguson Carburetor: #6195-A, 6307-A, 6371-A, 6401-A, 6683-A, 6684-A, 852186, 1810532-M91, 181-643-M91, 181-644-M91, 181-740-M91, 183-576-M91, 194064-M92, 194065-M92, 761-301-M91, 761-304-M91, TO-9510, TO-9510-1, TO-9510-B1 Massey Ferguson: #15480A Replaces: Marvel Schebler: #30-600</p>		

B9023-004	Marvel-Schebler Carburetor Float	\$19.95
 <p>Massey Harris Tractors Model 33, 333 Fits Carburetor: Marvel-Schebler Carburetor: #TSX-505, TSX-506, TSX-506A, TSX-592, TSX-596, TSX-695, TSX-772, TSX-843, TSX-856, TSX-884, TSX-893, TSX-947SL, TSXU-835, TSXU-836, TSXU-840, TSXU-963 Massey Ferguson Carburetor: #184-301-M92, 190-383-M91, 190-383-M92, 191-494-M91, 520-736-M91, 764-920-M91, 766-576-M91, 768-190-M91, 768-191-M91770-079-M91 Replaces: Massey Ferguson: #1508838M91 Marvel Schebler: #30-631, 30-739</p>		

B9023-011	Zenith Carburetor Float	\$34.50
 <p>Massey Harris Tractors Model 44, 44H, 44K, 44-6, 444, 55, 55K, 55KS, Challenger, Pacemaker Fits Carburetor: Zenith Carburetor: #S1214, 8503, 10279, 10285, 10444, 10445, 11523, 11524, 11622, 11629, 11644, 11979, 14644 Massey Harris Carburetor: #6068-A, 6809, 6810-A, 6826, 761-504-M91, 761-544-M91, 765-218-M91, 765-219-M91, 768-219-M91, 768-476-M91, 768-496-M91 Replaces: Zenith: #C85-26, 17720A, S808, S1247</p>		

CARBURETOR ACCESSORIES

B9038-003	Carburetor Elbow Fuel Line Fitting with Strainer	\$7.99
	<p>Elbow Fuel Line Fitting with strainer for IHC carburetors. 1/8" Pipe to 1/4" Flare. Works with Carter UT Series and Various Marvel-Schebler Carburetors.</p> <p>Fits: Massey Harris - Pony, 101 Jr, 101 Sr, 22, 30, 33, 44, 50, 55, 81, Challenger, Colt (21), GP 4WD, Mustang (23), Pacemaker, Pacer (16), 20, 20K, 22K, 30K, 44 Special, 44-6, 44K, 55K, 82, 102 Jr, 102 Sr, 201, 202, 203, 333, 404, 444, 555</p>	
B9038-007	2" Sediment Bowl Gasket	\$2.19
	<p>2" Outer Diameter, Bowl to Body; Fits a 1.28" Tall Glass Bowl</p> <p>Massey Harris</p> <p>Fits: Pony 11, 16 Pacer, 50 (Gas)</p>	

FUEL SEDIMENT BOWLS

B9036-002	Fuel Sediment Bowl	\$34.99
	<p>Has a 3/8" Pipe Inlet, 1/8" Pipe Outlet, and a 2.315" tall glass bowl</p> <p>Massey Harris</p> <p>Replaces: 21268A</p> <p>Fits (using 2.315 Long Glass Bowl): 101 Jr, 101 Sr, 22, 30, 33, 44, 55, 81, Colt (21), Mustang (23), 20, 22K, 44 SPECIAL, 44-6, 82, 102 Jr, 102 Sr, 304 Gas, 333, 444, 555</p>	

Parts for Sediment Bowl Above

B9038-024	Connector w/ Female Fitting	\$8.99
B9038-008	2" Sediment Bowl Screen	\$3.99
B9038-012	Sediment Bowl Gasket	\$2.99

B9036-003	Fuel Sediment Bowl	\$20.75
	<p>Has a 3/8" Pipe Inlet and a 1/4" Pipe Outlet.</p> <p>Massey Harris</p> <p>Replaces: 180141M91</p> <p>Fits: 50 Gas</p>	

B9038-011	Sediment Bowl Screen	\$2.75
	<p>1 3/4" Diameter, Square Hole Screen, Silicon Bronze Alloy,</p> <p>Fits B9036-003 above</p>	

MAYTAG

SPARK PLUG WIRE SETS

Our Spark Plug Wire Sets Come **Fully Assembled with the Proper Type Wire & Terminals.**

They are Custom Tailored to Look & Fit Like Original Factory Equipment.



Maytag Single

1 Cyl. Tailored Spark Plug Wire Set

B1035-001	Original Type Cotton Braid Wire	\$8.00
------------------	--	---------------

Maytag Twin

(Specify Either Eiseman or WICO Magneto)

2 Cyl. Tailored Spark Plug Wire Set

B1035-002	Original Type PVC Wire	\$14.50
B1035-002E	EPDM Wire	\$17.50

B4015-019	Coil	\$175.00
	<p>Eisemann-Style Magneto Coil for Maytag Model 72 D/DA 2-Cylinder Twin Engines</p>	

MINNEAPOLIS- MOLINE

TABLE OF CONTENTS

Spark Plug Wire Sets	343
Battery Cable	344
Wire Harnesses	345
Tune Up Parts (with Distributor)	347
Replacement Distributors	349
Electronic Ignition Conversion Kits	350
Tune Up Parts (with Magneto)	350
Magnetos	351
Gauges	351
Tachometer Drive Cables	352
Switches	352
Cutout Relays & Voltage Regulators	355
Identification Tags	355
Alternators	356
Lights & Light Parts	356
Auxiliary Plugs & Sockets	358
Cigarette Lighters	358
Carburetor Rebuild Kits	358
Carburetor Floats	359
Carburetor Accessories	360
Fuel Sediment Bowls	360
Fuel System Accessories	360

Minneapolis Moline G705, G706, G900, G1000, G1000 Vista, G1050, G1350, G1355 Gas

6 Cyl. Tailored Spark Plug Wire Set

B1036-003	Original Type PVC Wire	\$43.00
B1036-003E	EPDM Wire	\$51.75
B1036-003S	Suppression Wire	\$51.75

Minneapolis Moline GB, GT, GTA, GTB

4 Cyl. Tailored Spark Plug Wire Set

B1036-005	Original Type Cotton Braid Wire	\$23.75
B1036-005E	EPDM Wire	\$26.00
B1036-005S	Suppression Wire	\$26.00
B1036-005CS	Cotton Suppression Wire	\$40.75

Minneapolis Moline I-500

4 Cyl. Tailored Spark Plug Wire Set

B1036-006	Original Type PVC Wire	\$21.50
B1036-006E	EPDM Wire	\$26.00

Minneapolis Moline M5

6 Cyl. Tailored Spark Plug Wire Set

B1036-007	Original Type PVC Wire	\$21.50
B1036-007E	EPDM Wire	\$26.00
B1036-007S	Suppression Wire	\$26.00

Minneapolis Moline R

4 Cyl. Tailored Spark Plug Wire Set

B1036-008	Original Type Cotton Braid Wire	\$30.25
B1036-008E	EPDM Wire	\$33.00
B1036-008S	Suppression Wire	\$33.00
B1036-008CS	Cotton Suppression Wire	\$52.25

Minneapolis Moline U Series

UB (UB Special, see below), UBU, UT, UTC, UTE, UTS, UTU

4 Cyl. Tailored Spark Plug Wire Set

Early, with Replacement Distributor

B1036-010	Original Type Cotton Braid Wire	\$30.25
B1036-010E	EPDM Wire	\$33.00
B1036-010S	Suppression Wire	\$33.00

Late, with with 283A Engine

B1036-011	Original Type Cotton Braid Wire	\$30.25
B1036-011E	EPDM Wire	\$33.00
B1036-011S	Suppression Wire	\$33.00
B1036-011CS	Cotton Suppression Wire	\$52.25

Minneapolis Moline UB Special

4 Cyl. Tailored Spark Plug Wire Set

B1036-012	Original Type Cotton Braid Wire	\$30.25
B1036-012E	EPDM Wire	\$33.00
B1036-012S	Suppression Wire	\$33.00
B1036-012CS	Cotton Suppression Wire	\$52.25

SPARK PLUG WIRE SETS

Our Spark Plug Wire Sets Come Fully Assembled with the Proper Type Wire & Terminals.

They are Custom Tailored to Look & Fit Like Original Factory Equipment.

Varieties include:

Cotton Braid Wire: Copper Core with a Cotton Jacket.

PVC Wire: Copper Core with a Rubber Jacket.

EPDM Wire (E): Hi Performance Premium Conductor with a Tinned Copper Core, EPDM Silicone Insulation, and a Rubber Jacket.

Suppression Wire (S): for Electronic Ignition and is Spiral Wound, Ultra Low-Ohm, with EPDM Silicone Insulation and a Rubber Jacket.

Cotton Braid Suppression Wire (CS): also for Electronic Ignition, as Suppression Wire, but has an additional layer of Cotton Braid & Lacquer to replicate the vintage look, as well.



Minneapolis Moline BF, BG "1 Row"

4 Cyl. Tailored Spark Plug Wire Set

B1036-001	Original Type Cotton Braid Wire	\$23.75
B1036-001E	EPDM Wire	\$26.00
B1036-001S	Suppression Wire	\$26.00
B1036-001CS	Cotton Suppression Wire	\$40.75

Minneapolis Moline V

4 Cyl. Tailored Spark Plug Wire Set

B1036-009	Original Type Cotton Braid Wire	\$30.25
B1036-009E	EPDM Wire	\$33.00
B1036-009S	Suppression Wire	\$33.00
B1036-009CS	Cotton Suppression Wire	\$52.25

Minneapolis Moline ZAE, ZAN, ZAS, ZASI, ZAU, ZBE, ZBM, ZBU, ZM, ZTE, ZTI, ZTN, ZTS, ZTU, ZTX

4 Cyl. Tailored Spark Plug Wire Set

B1036-019	Original Type Cotton Braid Wire	\$30.25
B1036-019E	EPDM Wire	\$33.00
B1036-019S	Suppression Wire	\$33.00
B1036-019CS	Cotton Suppression Wire	\$52.25

Minneapolis Moline ZTE, ZTI, ZTN, ZTS, ZTU, ZTX with Magneto & 185 Engine

4 Cyl. Tailored Spark Plug Wire Set

B1036-020	Original Type Cotton Braid Wire	\$31.75
B1036-020E	EPDM Wire	\$34.50

Minneapolis Moline JET STAR

4 Cyl. Tailored Spark Plug Wire Set

B1036-034	Original Type PVC Wire	\$21.50
B1036-034E	EPDM Wire	\$26.00
B1036-034S	Suppression Wire	\$26.00

Minneapolis Moline JET STAR 3

4 Cyl. Tailored Spark Plug Wire Set

B1036-040	Original Type PVC Wire	\$21.50
B1036-040E	EPDM Wire	\$26.00
B1036-040S	Suppression Wire	\$26.00

Minneapolis Moline U302 Gas

4 Cyl. Tailored Spark Plug Wire Set

B1036-035	Original Type PVC Wire	\$21.50
B1036-035E	EPDM Wire	\$26.00
B1036-035S	Suppression Wire	\$26.00

Minneapolis Moline 335, 445

4 Cyl. Tailored Spark Plug Wire Set

B1036-036	Original Type PVC Wire	\$21.50
B1036-036E	EPDM Wire	\$26.00
B1036-036S	Suppression Wire	\$26.00

Minneapolis Moline M670 & 5 STAR

4 Cyl. Tailored Spark Plug Wire Set

B1036-038	Original Type PVC Wire	\$21.50
B1036-038E	EPDM Wire	\$26.00
B1036-038S	Suppression Wire	\$26.00

Minneapolis Moline 4 STAR

4 Cyl. Tailored Spark Plug Wire Set

B1036-006	Original Type PVC Wire	\$21.50
B1036-006E	EPDM Wire	\$26.00
B1036-006S	Suppression Wire	\$26.00

BATTERY CABLES



Our Battery Cables are made from the Proper Gauge Copper, as either Black Cotton Braided Wire or PVC Wire (whichever is correct for the application), using Soldered & Heat Sealed Brass or Copper Terminals.

Minneapolis Moline BF, BG "1 Row"

B2000-007	Positive Ground Strap	\$14.50
B2036-001	Negative Battery Cable	\$44.50

Minneapolis Moline GTA

B2036-045	Negative Battery Cable	\$49.25
------------------	------------------------	----------------

Minneapolis Moline GTB

B2000-005	Positive Ground Strap	\$12.50
B2036-003	Negative Battery Cable	\$39.00

Minneapolis Moline GVI

B2000-007	Positive Ground Strap	\$14.50
B2036-004	Negative Battery Cable	\$66.75

Minneapolis Moline R, RTI, RZ (Early)

with battery box on platform

B2000-006	Positive Ground Strap	\$13.50
B2036-046	Negative Battery Cable	\$68.25

Minneapolis Moline R, RTI, RZ (Late)

with battery box under fuel tank

B2000-005	Positive Ground Strap	\$12.50
B2036-005	Negative Battery Cable	\$39.00

Minneapolis Moline U Gas

B2000-005	Positive Ground Strap	\$12.50
B2036-008	Negative Battery Cable	\$36.75

Minneapolis Moline U LP

B2000-005	Positive Ground Strap	\$12.50
B2036-045	Negative Battery Cable	\$49.25

Minneapolis Moline UB, UTS

B2000-007	Positive Ground Strap	\$14.50
B2036-009	Negative Battery Cable	\$39.00

Minneapolis Moline UTI

B2000-005	Positive Ground Strap	\$12.50
B2036-009	Negative Battery Cable	\$39.00

Minneapolis Moline UTN

B2000-007	Positive Ground Strap	\$14.50
B2036-008	Negative Battery Cable	\$36.75

Minneapolis Moline UNI

B2000-007	Positive Ground Strap	\$14.50
B2036-011	Positive Battery Cable	\$39.25

Minneapolis Moline V

B2036-013	Positive Battery Cable, with Armor	\$33.75
B2036-014	Negative Battery Cable	\$36.50
B2036-015	Switch to Starter Cable	\$66.75

Minneapolis Moline Z, ZA, ZB

B2000-007	Positive Ground Strap	\$14.50
B2036-016	Negative Battery Cable	\$36.75

Minneapolis Moline ZTN, ZTS, ZTU

B2000-002	Positive Ground Strap	\$9.50
B2036-019	Negative Battery Cable	\$39.00
B2036-022	Switch to Starter Cable	\$54.75

Minneapolis Moline Jet Star

B2036-023	Positive Battery Cable	\$69.50
B2000-007	Negative Ground Strap	\$14.50

Minneapolis Moline Jet Star 3

B2036-047	Positive Battery Cable	\$70.75
B2000-007	Negative Ground Strap	\$14.50

Minneapolis Moline 4 Star Gas

B2036-024	Positive Battery Cable	\$66.75
B2000-007	Negative Ground Strap	\$14.50

Minneapolis Moline 4 Star Diesel

B2000-007	Negative Ground Strap	\$14.50
------------------	-----------------------	----------------

Minneapolis Moline 4 Star Super

B2036-024	Positive Battery Cable	\$66.75
B2000-007	Negative Ground Strap	\$14.50

Minneapolis Moline 5 Star Gas

B2036-024	Positive Battery Cable	\$66.75
B2000-007	Negative Ground Strap	\$14.50

Minneapolis Moline 5 Star Diesel

B2000-007	Negative Ground Strap	\$14.50
------------------	-----------------------	----------------

Minneapolis Moline M5 Gas

B2036-024	Positive Battery Cable	\$66.75
B2000-007	Negative Ground Strap	\$14.50

Minneapolis Moline M5 Diesel

B2000-007	Negative Ground Strap	\$14.50
------------------	-----------------------	----------------

Minneapolis Moline

335, 445 (Row Crop & Standard)

B2000-006	Positive Ground Strap	\$13.50
B2036-027	Negative Battery Cable	\$51.50

Minneapolis Moline

G705, G706, G707, G708 Diesel

B2036-030	Positive Battery Cable (Made as Original "T" Shape)	\$160.00
B2036-031	Negative Battery Cable (2 Used, Each Sold Separately.)	\$28.75
B2036-032	Switch to Starter Cable (2-Piece Set)	\$59.75

Minneapolis Moline M602, M604

B2036-042	Positive Battery Cable	\$66.75
B2000-007	Negative Ground Strap	\$14.50

Minneapolis Moline M670 Gas

B2000-007	Negative Ground Strap	\$14.50
------------------	-----------------------	----------------

Minneapolis Moline M670 Diesel

B2036-044	Positive Battery Cable	\$177.75
<i>Made as Original "T" Shape</i>		
B2000-007	Negative Ground Strap	\$14.50

Can add Original type Steel Armor for an additional cost of \$20.00



WIRING HARNESSSES

Our Wire Harnesses are made with our premium cotton braid and/or PVC wire.

They have the correct gauge, color, wire, & fuse holders (if needed).

All terminals are soldered according to the original.

(Harnesses do not include Battery Cables & Spark Plug Wires; however, we can supply these as separate products.)

NO HIDDEN COSTS, NOTHING EXTRA TO BUY!

Minneapolis Moline BF, BG "1 Row"

Complete Wire Harness

B3036-001	Original Design	\$193.75
B3036-073	Modified for a 1-Wire Alternator	\$193.75
B3036-090	Modified for a 10SI Alternator	\$193.75

Minneapolis Moline G705, G706 Diesel

B3036-069	Complete Wire Harness	\$452.25
------------------	-----------------------	-----------------

Minneapolis Moline G707, G708 Diesel

B3036-071	Complete Wire Harness		\$452.25
------------------	------------------------------	--	-----------------

Minneapolis Moline G900 Gas & LP (Is a close fit for G1000 Gas & LP too)

B3036-084	Complete Wire Harness		\$452.25
------------------	------------------------------	--	-----------------

Minneapolis Moline G900 Diesel

Complete Wire Harness

B3036-077	Original Design with a 10DN Alternator		\$465.50
B3036-079	Modified for a 1 Wire Alternator		\$465.50

Minneapolis Moline G1000 Diesel (Fits Vista too)

B3036-087	Complete Wire Harness		\$535.50
------------------	------------------------------	--	-----------------

Minneapolis Moline GB, GTA, GTB Gas

Complete Wire Harness

B3036-081	Original Design with Generator & Voltage Regulator		\$241.00
B3036-082	Modified for a 1 Wire Alternator		\$241.00

Minneapolis Moline JetStar 3 Super Gas/Diesel

Complete Wire Harness

B3036-064	Original Design		\$437.75
B3036-086	Modified for a 1 Wire Alternator		\$437.75

Minneapolis Moline M602, M604

Complete Wire Harness

B3036-067	Original Design		\$249.25
B3036-088	Modified for a 1 Wire Alternator		\$249.25

Minneapolis Moline M670 Super Gas & LP

B3036-083	Complete Wire Harness		\$452.25
B3036-089	Key Switch Adapter Harness	Connects #B3036-083 Harness with #B5003-019 Key Switch	\$19.75

Minneapolis Moline M670 Super Diesel

Complete Wire Harness

B3036-066	Original Design		\$437.75
B3036-091	Modified for a 1 Wire Alternator		\$437.75

Minneapolis Moline R, RT, RTI, RTN, RTS, RTU

Complete Wire Harness

B3036-003	with Cutout Relay		\$203.00
B3036-004	with Voltage Regulator		\$203.00
B3036-076	Modified for a 1 Wire Alternator		\$203.00

Minneapolis Moline U, UB, UBU, UT, UTC, UTE, UTS

Gas with A283 Engine

Complete Wire Harness

B3036-014	with Cutout Relay		\$227.75
B3036-015	with Voltage Regulator		\$227.75
B3036-078	Modified for a 1 Wire Alternator		\$227.75

Minneapolis Moline U, UB, UBU, UT, UTC, UTE, UTS

LP with A283-A Engine

Complete Wire Harness

B3036-016	with Cutout Relay		\$241.00
B3036-017	with Voltage Regulator		\$241.00
B3036-075	Modified for a 1 Wire Alternator		\$241.00

Minneapolis Moline U302 Super Gas/Diesel Late with 10DN Alternator

Gas (Serial #27601301 & Up)

Diesel (Serial #27700001 & Up)

Complete Wire Harness

B3036-064	Original Design		\$437.75
B3036-086	Modified for a 1 Wire Alternator		\$437.75

Minneapolis Moline ZAE, ZAN, ZASI, ZAU, ZBE, ZBM, ZBU, ZM

Complete Wire Harness

B3036-046	with Cutout Relay		\$227.75
B3036-047	with Voltage Regulator		\$227.75
B3036-085	Modified for a 1 Wire Alternator		\$227.75

Minneapolis Moline ZTU

B3036-092	Complete Wire Harness with Cutout Relay		\$227.75
------------------	--	--	-----------------

Minneapolis Moline 335, 445 Row Crop (Universal)

B3036-062	Complete Wire Harness		\$238.00
------------------	-----------------------	--	-----------------

Minneapolis Moline 335, 445 Utility

B3036-080	Complete Wire Harness		\$238.00
------------------	-----------------------	--	-----------------

Note

When ordering, please specify **Year** or **Serial Number**, Magneto/Distributor, & Regulator/Cut Out Relay.

Some Harnesses were originally made with PVC Wire & Braided; others were made with PVC Wire & Taped.

In those cases, we build them the **Original Way**.

TUNE UP PARTS (WITH DISTRIBUTOR)



Minneapolis Moline 4 Cylinder A, V

with Autolite/Prestolite Distributor

B4100-004 **\$14.75**



PCR Kit
Includes: Points (#B4001-005),
Condenser (#B4002-002), Rotor (#B4004-003)
Replaces:
Points - #1-4, 1-8, 1-9, 1-20, 1-22, 1-45,
IAD-3128S, IGP-3028ES, IGP3028FS,
IGS2224L, IGW3028AS
Condenser - #2-23, 2-31, 2-32, 2-34, 2-38, 2-42, IAT-2015L,
IAT-2015R, IAT-3076AS, IAT-3076BS, IAT-3076D, IAT-3076DS,
IAT-3076L, IAT-3076LA, IAT-3076R, IAT-3076RA,
IBB-2015L, IBB-2015R, IBB-2042-SS, IBB-2042SS-1, IBB-2042-SS3,
IG-2671F, IGH-3076, IGW-3139, 2098058, 3420600
Rotor - #4-10

	B4004-003 \$5.25 Rotor Premium Grade, Made in USA Replaces: #4-10
	B4003-003 \$21.00 Distributor Cap Made in the USA (Brass Contacts) Replaces: #IG-1324D, 3-11, 3-12

Did You Know?

Minneapolis-Moline pioneered the concept of the closed-cab farm tractor in 1938 by developing the UDLX Comfortractor.

Minneapolis Moline 4 Cylinder A, BF, BFH, BG, BIG, B-4, GB, GBD, GBLB, GTA, GTB, GTC Jet Star (With Distributor #1,111,711), Jet Star 3 (With Distributor #1,112,606), M5, R, RT, RTE RTN, RTS, RTU, V, UB, UBE, UBN, UBU, UT UTC, UTE, UTIL, UTN, UTS, UTU, UNI-TRACTOR (With Distributor #1,111,559), ZA, ZAE, ZAN, ZAS, ZAU, ZBE, ZBN, ZBU, ZT, ZTE ZTU, 4 Star (with Distributor #1,111,711), 5 Star 335, 445, 504, 550, 602, 604 with Delco distributor & clip on cap		
	B4100-001	\$10.50
	PCR Kit Includes: Points (#B4001-001), Condenser (#B4002-001), Rotor (#B4004-002) Replaces: Points - #D100HP, 1855720 Condenser - #1928111, D-203, 1869704, D-200 Rotor - #820445, D400	
	B4004-002	\$5.75
	Rotor Replaces: #820445, D400	
	B4003-001	\$13.50
	Distributor Cap Premium Grade, Made in the USA (Brass Contacts) Replaces: #811735, D300	
	B4006-001	\$9.99
	Dust Cover Replaces: #1900119	
	B4007-001	\$11.95
	Cap Clip Short Mount, 1 Used Replaces: #1889967, 1847289, 453844, 453461	
	B4007-002	\$11.95
	Cap Clip Long Mount, 1 Used Replaces: #1889967, 1889999, 453844, 453461	
	B4008-001	\$14.99
	Distributor Insulator Replaces: #1904376	
	B4009-001	\$25.99
	Distributor Bushing & Shim Kit	

Minneapolis Moline 4 Cylinder Jet Star, 4 Star, UNI-TRACTOR with Delco Distributor with Clip On Cap Fits # 1111898 & Others		
	B4100-001	\$10.50
	PCR Kit Includes: Points (#B4001-001), Condenser (#B4002-001), Rotor (#B4004-002) Replaces: Points - #D100HP, 1855720 Condenser - #1928111, D-203, 1869704, D-200 Rotor - #820445, D400	
	B4004-002	\$5.75
	Rotor Replaces: #820445, D400	
	B4003-001	\$13.50
	Distributor Cap Premium Grade, Made in the USA (Brass Contacts) Replaces: #811735, D300	
	B4006-001	\$9.99
	Dust Cover Replaces: #1900119	
	B4007-001	\$11.95
	Cap Clip Short Mount, 1 Used Replaces: #1889967, 1847289, 453844, 453461	
	B4007-002	\$11.95
	Cap Clip Long Mount, 1 Used Replaces: #1889967, 1889999, 453844, 453461	
	B4008-001	\$14.99
	Distributor Insulator Replaces: #1904376	
	B4009-001	\$25.99
	Distributor Bushing & Shim Kit	

*For 6- or 12-Volt Ignition Coils & Accessories, see p.44

Minneapolis Moline 4 Cylinder Jet Star 3, A4, B4, L4, U302, 11-302 with Delco Distributor with Screw Down Cap, Fits # 1112660 & others		
	B4100-003 PCR Kit Includes: Points (#B4001-012), Condenser (#B4002-012), Rotor (#B4004-013) Replaces: Points - #D108P Condenser - #D205 Rotor - #D-419R, 1963972	\$9.75
	B4004-013 Rotor Premium Grade, Made in the USA Replaces: #D-419R, 1963972	\$4.75
	B4003-015 Distributor Cap Brass Contacts Replaces: #D-322	\$16.25
B4006-004	Dust Cover Replaces: #1960325	\$16.99
Minneapolis Moline 6 Cylinder D-1, G-V1, G704, G705, G706, G707, G708, G900, G-950, G1000, G1050, G1350 with Delco Distributor & Clip On Cap Except With Distributors #1112662 & #1112684		
	B4100-001 PCR Kit Includes: Points (#B4001-001), Condenser (#B4002-001), Rotor (#B4004-002) Replaces: Points - #D100HP, 1855720 Condenser - #1928111, D-203, 1869704, D-200 Rotor - #820445, D400	\$10.50
	B4004-002 Rotor Replaces: #820445, D400	\$5.75
	B4003-002 Distributor Cap Premium Grade, Made in the USA (Brass Contacts) Replaces: #824735, D301	\$20.25
	B4006-001 Dust Cover Replaces: #1900119	\$9.99
	B4007-001 Cap Clip Short Mount, 1 Used Replaces: #1889967, 1847289, 453844, 453461	\$11.95

	B4007-002 Cap Clip Long Mount, 1 Used Replaces: #1889967, 1889999, 453844, 453461	\$11.95
	B4008-001 Distributor Insulator Replaces: #1904376	\$14.99
	B4009-001 Distributor Bushing & Shim Kit	\$25.99

*For 6- or 12-Volt Ignition Coils & Accessories, see p.44

Minneapolis Moline 6 Cylinder D-1, G704, G900, G-950, G1000, G1050, G1350 with Delco Distributors #1,112,662, 1,112,684 & Screw Down Cap		
	B4100-003 PCR Kit Includes: Points (#B4001-012), Condenser (#B4002-012), Rotor (#B4004-013) Replaces: Points - #D108P Condenser - #D205 Rotor - #D-419R, 1963972	\$9.75
	B4004-013 Rotor Premium Grade, Made in the USA Replaces: #D-419R, 1963972	\$4.75
	B4003-021 Distributor Cap Replaces: #1954569, D-316	\$8.75
B4006-004	Dust Cover Replaces: #1960325	\$16.99

*For 6- or 12-Volt Ignition Coils & Accessories, see p.44

Replacement Distributors

1112587N	New Delco #1112587 Distributor	\$345.00
	Brand New Delco Distributor #1112587. Has tachometer cable connection. Fits: Minneapolis Moline - G750	
1112587R	Rebuilt Delco #1112587 Distributor (See Fits Above)	\$325.00 outright \$225.00 exchange with \$100 core
	Rebuilt Delco Distributor #1112587 Does <u>not</u> have tachometer cable connection. Fits: Minneapolis Moline - G750	

ELECTRONIC IGNITION CONVERSION KITS

Replaces Points & Condenser



Minneapolis Moline 4 Cylinder A, V with Autolite/Prestolite Distributor		
B9600-057	12 Volt Negative Ground	\$129.95
B9600-057P12	12 Volt Positive Ground	\$147.45
B9600-057N6	6 Volt Negative Ground	\$147.45
B9600-057P6	6 Volt Positive Ground	\$147.45

Minneapolis Moline 4 Cylinder A, BF, BFH, BG, BIG, B-4, GB, GBD, GBLB, GTA, GTB, GTC, JET STAR, JET STAR 3, M5, R, RT, RTE, RTN, RTS, RTU, V, UB, UBE, UBN, UBU, UT, UTC, UTE, UTIL, UTN, UTS, UTU, UNTRACTOR, ZA, ZAE, ZAN, ZAS, ZAU, ZBE, ZBN, ZBU, ZT, ZTE, ZTU, 4 STAR, 5 STAR, 335, 445, 504, 550, 602, 604 with Delco Distributor & Clip On Cap		
B9600-006	12 Volt Negative Ground	\$147.45
B9600-006P12	12 Volt Positive Ground	\$165.45
B9600-006P6	6 Volt Positive Ground	\$165.45

Minneapolis Moline 4 Cylinder JET STAR 3, A4, B4, L4, U302, 11-302, Super 670 with Delco Distributor & Screw Down Cap		
B9600-009A	12 Volt Negative Ground	\$124.95
B9600-009AP12	12 Volt Positive Ground	\$139.95

Minneapolis Moline 6 Cylinder D-1, G-V1, G704, G705, G706, G707, G708, G900, G-950, G1000, G1050, G1350 with Delco Distributor & clip on cap (Not Used with Distributor #1112662, & 1112684)		
B9600-255LS	12 Volt Negative Ground	\$162.45
B9600-255LSP12	12 Volt Positive Ground	\$175.45
B9600-255LSP6	6 Volt Positive Ground	\$175.45



Minneapolis Moline 4 Cylinder M670, U-302 with Delco Distributor #1112660		
B9600-010A	12 Volt Negative Ground	\$124.95

Minneapolis Moline 6 Cylinder D-1, G704, G900, G-950, G1000, G1050, G1350 with Delco Distributor #1112662, 1112684 & Screw Down Cap		
B9600-014A	12 Volt Negative Ground	\$124.95
B9600-014AP12	12 Volt Positive Ground	\$139.95



For Ignition Coils & Accessories,
see p.44

TUNE UP PARTS (WITH MAGNETO)

with American Bosch MRF Magnetos, including #MRF-4A & MRF-6A		
	B4011-015	\$32.50
	Points Replaces: #CS521, AS3	
	B4012-012	\$22.50
	Condenser Replaces: #CW5291AS	

Minneapolis Moline with Fairbanks-Morse Magnetos #FM-R6B, FM-XOR6A, FM-XOR6B, FM-XR6B, FM-Z6A, FM-Z6B		
	B4014-017	\$36.50
	Rotor Replaces: #Z2765	
	B4013-036	\$87.50
	Cap Replaces: #Q800 Includes Cap Brush	

Rebuilt Magnetos

Our Rebuilt Magnetos are completely torn down, cleaned, & inspected. They will (at the minimum) have the following new parts: Points, Condenser, Coil, Coil Insulators, Lead-out Tower, & Outside Covers, plus any additional parts that are needed to make the unit look & perform like new.

They come with a 1-Year Limited Warranty.

Notes:



1. Unless otherwise specified, cost is exchange price.
2. A core charge (see below) will be charged to your credit card until we receive your good core.
3. A good core is considered a complete magneto with no cracks or weld repairs. Only good cores will be credited.

*Magnetos must be used with copper ignition wire.
Use of any other type will Void the Warranty.*

	XH184R	Exchange	\$445.00
		Outright	\$645.00
Rebuilt WICO Magneto 4 Cyl. Base Mount Core Charge: \$200.00			
	XH1916R	Exchange	\$445.00
		Outright	\$645.00
Rebuilt WICO Magneto Core Charge: \$200.00 Fits Minneapolis Moline ZT, RT Power Units - 206-4A, 165-4A, 283-4A, 403-4A, 483-4A			

GAUGES

Ammeters, Universal



B9025-002	Ammeter 20-0-20	\$19.99
	Has a black face with white lettering and a chrome bezel Does not have a logo Dimensions: Fits in 2" Diameter Hole 1.850" From Post to Bottom of Bezel	
B9025-008	Ammeter 60-0-60	\$19.99
	Has a black face with white lettering & a chrome bezel Uses threaded terminals and is dash mounted Used with 12-Volt Alternator Systems Dimensions:Fits in 2" Diameter Hole Measures 1.765" from Top of Post to Bottom of Bezel	
B9025-005	Ammeter 30-0-30	\$19.99
	Minneapolis Moline Fits: A, BF, BG, BIG, Big Mo 400, Big Mo 500, Big Mo 600, G, GB, GBD, GBLP, GG, GT, GTA, GTB, GTBD, GTC, GVI, JetStar 3 Super, R, RT, RTE, RTI, RTN, RTS, RTU, U, U302, U302 Super, UB, UB Special, UBD, UBE...	

UBED, UBN, UBND, UBU, UBUD, UDI, UDLX, UT, UTC, UTE, UTI, UTN, UTS, UTSD, UTSD-M, UTU, V, Z, ZA, ZAE, ZAI, ZAN, ZAS, ZAU, ZB, ZBE, ZBN, ZBU, ZT, ZTE, ZTI, ZTN, ZTS, ZTU

Ammeters, Minneapolis Moline

B9025-043	Minneapolis Moline 30-0-30 Ammeter	\$32.99
	Restoration Quality Ammeter For Minneapolis Moline Tractors 30-0-30 Ammeter Range Minneapolis Moline Replaces: #30-3485560, 10A8171, BE455A Fits: [Big Mo 400, JetStar, 335, 445, 500, 600 (Without Gauge Cluster)], G, G705, G706, G707, G708, GVI, M5, M602, M604, M670, M670 Super, R, U, Z	

Oil Pressure Gauges, Universal

B9025-001	Universal Oil Pressure Gauge (0-80 PSI)	\$24.99
	Has 1/8" NPT Male Threads, studs, & a bracket. No logo, dash mounted, requires a 2" diameter hole. Minneapolis Moline Fits: G1000, G1000 Vista, G1050, G900, G950 (& others using 80 Lb. Gauge)	
B9025-004	Universal Oil Pressure Gauge (0-50 PSI)	\$21.99
	Has 1/8" NPT Male Threads, studs, & a bracket. No logo, dash mounted, requires a 2" diameter hole. Minneapolis Moline Fits: 2 Star, 4 Star, 5 Star, A, BF, BG, Big Mo 400, Big Mo 500, Big Mo 600, G, G550, G705, G706, G707, G708, G750, GB, GBD, GBLP, GT, GTA, GTB, GTBD, GTC, GTI, GTS, GVI, JetStar, JetStar 2, JetStar 3, JetStar 3 Super, M5, M504, M602, M604, M670, M670 Super, R, RT, RTE, RTI, RTN, RTS, RTU, U, UB, UB Special, UBD, UBE, UBED, UBN, UBND, UBU, UBUD, UDI, UDLX, UDS, UDS-M, UDU, UT, UTC, UTE, UTI, UTN, UTS, UTS Special, UTSD, UTSD-M, UTU, V, Z, ZA, ZAE,ZAN, ZAS, ZAU, ZB, ZBE, ZBN, ZBU, ZTI, ZTN, ZTS, ZTU	

Oil Pressure Gauges, Minneapolis Moline

B9025-044	Minneapolis Moline Oil Pressure Gauge (0-50 PSI)	\$39.99
	Restoration Quality Oil Pressure Gauge For Minneapolis .Moline Dash Mounted Gauge with 1/8" Male Pipe Threads Minneapolis Moline Fits: [Big Mo 400, JetStar, 335, 445, 500, 600 (Without Gauge Cluster)], G, G705, G706, G707, G708, GVI, M5, M602, M604, M670, M670 Super, R, U, Z Replaces: #JT854, 30-3485471, 10A7986	

Oil Pressure Gauge, Line Kit

B9026-001	Oil Pressure Gauge Line Kit	\$29.99
	<p>6 FT copper 1/8" line --- Kit includes: (2) 5/16 - 24 UNF nut, (2) compression sleeves, (1) 1/8 - 27 NPTF female to 5/16" - 24 UNF male adapter --- Note: Depending on application customer may be required to purchase other fittings.</p>	

B9026-004	Oil Pressure Gauge 1/4" to 1/8" NPT Adapter Fitting	\$15.99
	<p>Adapter Fitting for Oil Gauges - 1/4" to 1/8" NPT. Minneapolis Moline Fits: BF, BG, GB, GTA, GTB, GTC, GVI, JetStar, R, RT, RTE, RTN, RTS, RTU, U, UB, UBE, UBN, UB Special, UBU, UT, UTC, UTE, UTN, UTS, Z, ZAE, ZAN, ZAS, ZAU, ZBE, ZBN, ZBU, ZTN, ZTS, ZTU, 335, 445, 4 Star, 5 Star</p>	

Water Temperature Gauge, Universal

B9025-006	Water Temperature Gauge	\$34.99
	<p>Includes an Aluminum Sealing Washer to Seal Probe. It has a Chrome Bezel with White, Green, Red Zones on a Black Gauge Face. Has a 1/2" NPT Pipe Bushing and Probe Length of 1.279". Minneapolis Moline Replaces: 10A21284, 10A2229, 15A9741 Fits: A, BG, Big Mo 400, Big Mo 500, Big Mo 600, G, GB, GBD, GBLP, GT, GTA, GTB, GTBD, GTC, GTI, GTS, JetStar, JetStar 2, JetStar 3, M5, M504, M602, M604, M670, M670 Super, R, RT, RTE, RTI, RTN, RTS, RTU, U, UB, UBD, UBE, UBED, UBN, UBND, UB Special, UBU, UBUD, UDI, UDS, UDS-M, UDU, UT, UTC, UTE, UTI, UTN, UTS, UTSD, UTSD-M, UTS Special, UTU, V, Z, ZA, ZAE, ZAN, ZAS, ZAU, ZB, ZBE, ZBN, ZBU, ZT, ZTE, ZTI, ZTN, ZTS, ZTU, 2 Star, 4 Star, (And Other Models Using 60" Capillary Lead)</p>	

B9025-007	Universal, Water Temperature Gauge	\$34.99
	<p>Dash-mounted (parts included), 72" long heavy duty capillary tube included (check length before ordering) Minneapolis Moline Fits: [BG, BIG, Big Mo 400, Big Mo 500, Big Mo 600, G, GB, GBD, GBLP, GT, GTA, GTB, GTBD, GTC, GTI, GTS, JetStar, JetStar 2, JetStar 3, M5, M504, M602, M604, M670, M670 Super, R, RT, RTE, RTI, RTN, RTS, RTU, U, U302, UB, UBD, UBE, UBED, UBN, UBND, UB Special, UBU, UBUD, UDLX, UDS, UDS-M, UDU, UT, V, Z, ZA, ZAE, ZAN, ZAS, ZAU, ZB, ZBE, ZBN, ZBU, ZT, ZTE, ZTI, ZTN, ZTS, ZTU, 2 Star, 4 Star (And Others Using 72" Or Shorter Capillary Lead)]</p>	

Water Temperature Gauge, Minneapolis Moline

B9025-045	Minneapolis Moline Water Temperature Gauge	\$45.99
	<p>Restoration Quality Dimensions: 5/8" - 18 U.F END W/ 1/2" NPT Male Pipe Aapter. Capillary Length Of 72" Minneapolis Moline Replaces: #10A2229, 30-3485587, 10A2794 Fits: [Big Mo 400, JetStar, 335, 445, 500, 600 (Without Gauge Cluster)], G (4 Cylinder Only), [GB, GBLP, GTA, GTB, GTC (Some)], R, RT, RTE, RTI, RTN, RTS, RTU, U, UB, UB Special, UBE, UBN, UBU, UTC, UTE, UTI, UTN, UTS, UTU, Z, ZA, ZAE, ZAN, ZAS, ZAU, ZB, ZBE, ZBN, ZBU, ZT</p>	

Tachometer Drive Cables



B9026-003	56" Tachometer Drive Cable	\$34.99
	<p>Restoration Quality. Drive Cable for Tachometers. Measures 56" Outer Sheath Length. 5/8"-18 x 7/8"-18 Threads With Key On One End. Please Check Length Before Ordering. Minneapolis Moline Fits: G550, G750 (Gas)</p>	

SWITCHES & KNOBS

Knobs

B5001-009	Combo Light Switch Knob	\$6.99
	<p>Fits #B9017-010, B9016-018, B9016-032, B9016-033. Also fits original equipment combo rear lights when 'handle' style knob is required. Minneapolis Moline Fits: G1355, G1365, GB, GTB, GVI, JetStar, M5, M602, U, Z, 335, 3 Star, 4 Star, 5 Star</p>	

Push/Pull Switches

B5002-001	2 Position Push/Pull Switch	\$7.75
	<p>OFF/ON Universal 2 Position Push/Pull (2 Screw Terminals) Mounting Stem 3/8"-32 Thread Knob #10/32 Thread</p>	
B5002-005	3-Position Push/ Pull Switch	\$29.75
	<p>Low Charge/High Charge/Lights (3 Position Switch) 3 Screw Type Mounting Stem .8" Thread Knob #10/32 Thread Premium Quality Made by the OEM Manufacturer</p>	

B5002-004	Heavy Duty Push/Pull Magneto Switch	\$8.25
	ON/OFF (2 Position) Push/Pull Magneto Switch (2 Screw Terminals) Mounting Stem 3/8"-32 Thread Knob #10/32 Thread	

B5003-019	Minneapolis Moline 3 Position Key Switch	\$32.99
	Includes 2 Keys. 3 Screw Terminals with 9/16"-24 UNEF Threaded Stem. Minneapolis Moline Replaces: #10A22293, 10V22293 Fits: G1000, G900, Jetstar 3 Super, M670 Super, U302, U302 Super	

B5003-027	Indak Style Key (for switch above)	\$4.99
------------------	---	---------------

Key Switches

B5003-001	2 Position Battery Key Switch	\$14.75
	Universal OFF/ON 2 Position Key Switch (For Battery Ignition) (2 Screw Terminals) Mounting Stem 3/4"-20 Thread	

B5003-005	4 Position Ignition Key Switch	\$39.99
	Can replace the 4 terminal switch. 2 battery terminals, 5 Spade Terminals, OEM Style Delco Remy 995" Diameter Threaded End. Includes 2 Keys & Jam Nut Minneapolis Moline Replaces: #20-7101027 Fits: G1355, G955	

B5003-006	Ignition Key	\$4.99
	Key for Part Above, #B5003-005. Brass Finish Minneapolis Moline Fits (Using Delco Switch): G1355, G955	

B5003-008	Ignition Key Switch	\$24.99
	Includes 2 Keys, 2 Spade Terminals Designed for 0.800" hole diameter. Minneapolis Moline Fits: 2 Star, 4 Star, 5 Star, A, BF, Big Mo 400, Big Mo 500, Big Mo 600, GBD, GG, GT, GTA, GTB, GTBD, GTC, HD220, HD605, HD800, JetStar, JetStar 2, JetStar 3, M5, M504, M602, M604, M670, M670 Super, R, RT, U, UB, UBD, UBE, UBED, UBN, UBND, UBU, UBUD, UDLX, UT, V, ZA, ZAE, ZAN, ZAS, ZAU, ZB, ZBE, ZBN, ZBU, ZTI, ZTS, ZTU, 335, 445	

B5003-030	Ignition Switch / Key Switch	\$159.99
	OEM, 5-Position, 3 Screw Terminals Includes: resistor wire, 2 keys Minneapolis Moline Replaces: #10A23929, 10A7473, 10V23929 Fits: 445, 2 Star, 4 Star, 4 Star Super, 5 Star, Big Mo 400, Big Mo 500, Big Mo 600, G705, G706, GVI, JetStar 3, M5, M504, M602, M604	

Momentary Switches

B5004-003	Momentary Push Switch	\$15.75
	Manual Solenoid Switch with Rubber Protected Cap (2 Screw Terminals) Mounting Stem 5/8"-32 Thread Minneapolis Moline – Replaces: #72160068, 105386A, UT2421, K7392C, 10A972 Fits: [A4T1400, G, G705, G706, G707, G708, GB, GTA, GTB, GTC, GVI, JetStar 3, M5, M504, M602, M604, R, RTE, RTN, RTS, RTU, U, UB, UTC, UTE, UTN, UTS, UTU, ZA, ZAE, ZAN, ZAS, ZAU, ZB, ZBE, ZBN, ZBU (Starter Switch or Preheater Switch on following Gas & LP)], M670 (Gas & LP, (Up to SN #29901891), Starter Switch or Preheater Switch on following Gas & LP), M670 (Diesel (Up to SN #30000819), Starter Switch or Preheater Switch on following Gas & LP);	





B5004-007	Neutral Safety Switch	\$29.99
	Manual Push Button Safety Switch used as a Neutral Safety Switch. 2 Spade Terminals. 5/8"-32 Thread. 2.575" Total Length. For use as neutral safety switch. Minneapolis Moline Replaces: #10A25817, 30-3138739, 35A12407 Fits: 670 Super, A4T, A4T-1600, A4T1400, G1000 Vista (Lp Sn: 34500391 & up, Dsl Sn: 34600986 & up), G1050, G1350, G1355, G950, Jetstar 3 Super, M670 (Gas, Sn: 29904455 & up, Dsl Sn: 30002310 & up), U302, U302 Super	



B5004-008	Neutral Safety Switch	\$15.49
	Minneapolis Moline Replaces: 10A23729 Fits: 670 Super (Gas / Lp Sn: 29901892 to 29904454; Dsl to Sn# 30000819), G1000 (Lp Sn: 30500051 & up; Dsl. Sn: 30600101 & up), Jetstar 3 Super (Gas & Lp to Sn: 28304155; Dsl to Sn: 28400466), U302 Super (Gas / Lp Sn: 27601301 to 27602559)	

B5004-009	Neutral Safety Switch Boot	\$11.99
	Fits 1.000" Dia. Switch, 1.125" Deep, 0.140" Wire hole diameter. Minneapolis Moline Replaces: #10A20419 Fits: 670 Super (Gas / Lp Sn: 29901892 to 29904454; Dsl. to Sn: 30000819), Jetstar 3 Super (Gas / Lp to Sn: 28304155; Dsl to Sn: 28400466), G1000 (Lp Sn: 30500051 & up; Dsl Sn: 30600101 & up), U302 Super (Gas / Lp Sn: 27601301 to 27602559)	

STARTER SWITCHES

(MECHANICAL)

B5006-003	Saddle Mount Lever Switch	\$11.75
	Lever or Rod operated, 6 or 12 Volt, Starter Mounted Manual Push Button, Switch Has Bracket for Rocker Lever Replaces: Delco - #1872403, 1872405, 1882323, 1918405, 1919576, 1919600, 1925781, 1918405, 1919578, 1919600, 1923480, 1925781, 1932131, 1940047, D903, D904, D905, D908, D909 Fits: Minneapolis Moline - M504, &M604 With 1113080 Starter, 4 STAR, 335, 445, (with Push/Pull Rod)	
B5006-001	Starter Switch (Long Shaft)	\$12.75
	6 or 12 Volt Panel Mounted Manual Push Start Switch Replaces: Delco - #192119, D900, 450C Prestolite - #15-121, 15-122, 15-409, 15-45, 15-47, 15-50, 15-51, SW-2916, SW-4001, SW-4002, SW-4005, SW-4010, SW-4013, SW-4015, SW-4017, SW-4101, SWX-47 Fits: Minneapolis Moline - Various Models	
B5009-001	Starter Switch (Long Shaft)	\$39.99
	6/12-Volt, 30 Amp Combination Switch without Lever 5 Screw Type Terminals Minneapolis Moline Replaces: #10A3749, 10A971, 10A2071 Fits: GTB, GTC, [R, RT, RTE, RTI, RTN, RTS, RTU (SN #14802403 & Up)], U (SN #114802054 & Up), UB (Gas/LP), UTC (SN #1500101 & Up), UTE (SN #4300001 & Up), UTN (SN #3800205 & Up), UTS (Gas, SN #124802276 & Up), UTU (SN #114802054 & Up), ZAS (SN #701911 & Up), ZB, ZBE, ZBN, ZBU	
B5001-007	Combination Switch Lever w/ Hardware	\$6.25
	(For Use with #B5009-001, B5009-002, B5009-003, & B5009-004) Minneapolis Moline Replaces: #VT572 Fits: GTB, GTC, [R, RT, RTE, RTI, RTN, RTS, RTU (SN #14802403 & Up)], U (SN #114802054 & Up), UB (Gas/LP), UTC (SN #1500101 & Up), UTE (SN #4300001 & Up), UTN (SN #3800205 & Up), UTS (Gas, SN #124802276 & Up), UTU (SN #114802054 & Up), ZAS (SN #701911 & Up), ZB, ZBE, ZBN, ZBU	
B5011-004	Combination Switch Instruction Plate	\$17.99
	5 Position Faceplate For #B5009-001 Minneapolis Moline Replaces: #10R601, #10A974, #10A1802 Fits: G, GB, GBD, GBLP, GTB (Serial #1,603,165 & Up), GTC (Serial #4,700,001 & Up), R, RTE, RTI, RTN, RTS, RTU, U, UB, UT, UTC, UTE, UTI, UTN, UTS, UTU, Z, ZA, ZAE, ZAN, ZAS, ZAU, ZB, ZBE, ZBN, ZBU, ZTI, ZTN, ZTS, ZTU	

B5010-006	4-Position Rotary Light Switch	\$49.99
	4 Position Rotary Light Switch, <i>OEM</i> 5 Outer Terminals & Resistor Replaces: Minneapolis Moline - #10A25790, 10A23930 White - #10A25790 Fits: A4T, G1000, G1000 Vista, G1050, G1350, G900, G950, Jetstar 3 Super, M670, M670 Super, U302 Super	
B5011-006	Start Switch Lever	\$9.99
	Starter Rocker Switch Lever. Used with #B5006-003. Fits: Minneapolis Moline - Big Mo 400, Big Mo 500, JetStar, JetStar 2, 335, 445, 4 Star, 4 Star Super (Gas & LP)	

Quick Disconnect Terminal

B9004-043	GM Quick Disconnect			
	Qty 1-9	\$4.20	Qty 100-499	\$2.73
	Qty 10-25	\$3.36	Qty. 500-999	\$2.42
	Qty 26-99	\$3.05	Qty. 1000+	\$2.10
Minneapolis Moline Fits: R, RTI, RTU, U, UB, UTC, UTE, UTS, UTU, ZAE, ZAN, ZAS, ZAI, ZAU, ZBE, ZBM, ZBU, ZM, ZTU				

SOLENOIDS

B5007-001	6 Volt Solenoid	\$17.50
B5007-002	12 Volt Solenoid	\$17.50
	3 Terminal Solenoid With A Curved Mounting Bracket Replaces: Autolite - SAE-4005, 15-60, SAW-4201 Fits: Minneapolis Moline - (various)	
B5007-004	12 Volt Solenoid	\$23.75
	Has a Curved Bracket & 4 Terminals (Used with 30 & 35 MT Delco Starters) Replaces: Delco : #1119890, 1119912, 1119885, 1119877, 1119935, 1119882, 1119906, D953, D985, 1119833, 1119883, 1115537, 1119978, 1115582, 1119778, 1115508, 1115529, 1115540, 1115501 Minneapolis Moline - #1115510 Fits: M670 Super (Diesel with starter 1113654)	
B5007-024	Delco 12 Volt Solenoid	\$109.50
	12 Volt Rated Solenoid for Delco 40MT & 50MT Direct Drive Starters with 4 Terminals. Replaces: Delco - #1119835, 1119853, 1119862, 1119879, 1119895 Minneapolis Moline - #30-3090892 Fits: Minneapolis Moline - G1355	

CUTOUT RELAYS & VOLTAGE REGULATORS

Note: Due to modern battery design, voltage regulators can't be used to charge low or dead batteries. Doing so will destroy the voltage regulator and void the warranty.

6-Volt Saddle Mounted Cutout Relay (Delco Version)

B8001-004 Premium Quality, Made in the USA **\$122.50**

B8001-006 Standard Quality **\$38.59**



Cutout Relay, 25 Amp, 6 Volt, Works Positive or Negative Ground.

Replaces:

Delco - #266P, 266N, 265P, 265N, 5015850, 812970, 265J, 820845, 812971, 1116816, 265G, 265H, 1116755, 1116751, 1116809DR, 265B, 1842859, 265C, 1867781,

265F, 265D

Fits: Minneapolis Moline - A, BF, BG, UTS (to SN #1205553), UTU (To SN #1108297), V

6-Volt Delco Type Voltage Regulator

B8002-011 Premium Quality, USA Made **\$124.75**

B8002-012 Standard Quality **\$42.75**



6 Volt, 4 Terminals, Curved Mounting Bracket Regulator, Positive Ground Replaces:

Delco - #1116766, 1118265, 1118305, 1118433, 1118436, 1118790, D641, D642, D643, D647, D660, D661 **Prestolite** - #8-293, GRX-293

Fits: Minneapolis Moline - Fits: [R,

RTE, RTN, RTS (Gas, LP; 6-Volt; SN #14900001 & Up)], UTC (Gas, LP; 6-Volt; SN #1500101 & Up), UTE (Gas, LP; 6-Volt; SN #4300001 & Up), UTN (Gas, LP; 6-Volt; SN #3800205 # Up), UTS (Gas, LP; 6-Volt; SN #1205554 to 1210571), UTU (Gas, LP; 6-Volt; SN #1108298 & Up), [ZA, ZAS, ZAU (Gas, LP; 6-Volt; Up to SN #701910)], [ZAE, ZAN (Gas, LP; 6-Volt)]; Replaces: #10A20736]

B8002-006 **12-Volt Voltage Regulator** **\$67.50**



Minneapolis Moline

Fits: G704, G705, G706, G707, G708, G900, Jet Star 3, U302
Replaces: #35A5137, 10A17848
12 Volt, 3 Terminal, Negative Ground, Voltage Regulator
Premium Quality USA Made

B8002-029 **Regulator Shock Mount Kit** **\$23.95**



Used in Conjunction with #B8002-006, Delco Type Voltage Regulator
Replaces: Delco # 1910966, 1911028, 1911034, 1914863, 1915331, D32596

ALTERNATOR VOLTAGE REGULATORS

B8002-030 **Alternator Voltage Regulator** **\$14.50**



Heavy Duty, 12 Volt, Negative Ground Alternator Voltage Regulator. This external voltage regulator has 4 spade terminals (field, 2, 3, 4). It is designed for 'B' type circuits in negative ground systems. Designed for use only in 12 volt systems. For Delco 10DN, & 20DN

Replaces **Minneapolis Moline** - #10P3009

Delco - #D630, D635, D663, 1119513, 1119515, 1119508, 1119519, D663, 1119502, 1119516, 1119506, 1119512, 1119515 **Fits: Minneapolis Moline** G1000, G750, G900, JetStar 3, M670

IDENTIFICATION TAGS

B9013-001 **Small Autolite I.D. Tag (Blank)** **\$7.00**

Small Autolite I.D. Tag (Stamped) **\$14.25**



2 5/16" Long, Black I.D. Tag for Distributors, Starters, & Generators with Rivets

B9013-002 **Large Autolite I.D. Tag (Blank)** **\$7.00**

Large Autolite I.D. Tag (Stamped) **\$14.25**



2 15/16" Long, Black I.D. Tag for Distributors, Starters, & Generators with Rivets

B9013-004 **Delco Remy I.D. Tag (Blank)** **\$7.00**

Delco Remy I.D. Tag (Stamped) **\$14.25**



Black Delco-Remy I.D. Tag for Distributors, 6 Volt Starters, & 6 Volt Generators with Rivets, 3/4" 2 5/16"

B9013-005 **Red Delco Remy I.D. Tag (Blank)** **\$7.00**

Red Delco Remy I.D. Tag (Stamped) **\$14.25**



Red Delco-Remy I.D. Tag for 12 Volt Starters & 12 Volt Generators with Rivets, 3/4" 2 5/16"

B9013-013 **Delco Remy I.D. Tag (Blank)** **\$7.00**

Delco Remy I.D. Tag (Stamped) **\$14.25**



Black Delco-Remy I.D. Tag for Distributors, 6 Volt Starters, & 6 Volt Generators with Rivets, 3/4" 2 5/16"

ALTERNATORS

B6001-001	12 Volt Alternator (1 Wire)	\$112.75
------------------	------------------------------------	-----------------

63 Amp, Low Cut In, Specially Built For Tractors, Forklifts, & Other Low Engine Speed Applications



B6001-002	12 Volt Alternator (1 Wire/3 Wire)	\$118.75
------------------	---	-----------------

63 Amp, With 1 Wire Or 3 Wire For Warning Lamp On Automobiles & Trucks

B6001-005	6 Volt Alternator (1 Wire, Positive Ground)	\$166.50
------------------	--	-----------------

Small ND Type

B6002-003	12 Volt Small Denso Alternator (1 Wire)	\$119.75
------------------	--	-----------------



This 40 Amp, 1 Wire Internal Regulator Alternator will Start Charging with a Much Lower Engine Speed Than Most Other Alternators! Comes with a 4 1/2" Housing Diameter, 3/8 To 1/2" Belt width & a 2 1/2" Pulley Diameter. Perfect for the Machine That Requires a Smaller Alternator. Excellent for Converting a 6

Volt System to 12 Volt. Available as Negative Ground Only & is Self-Excited

LIGHTS & LIGHT PARTS

B9016-003	7" Flat Lens Type Head Lamp	\$99.99
------------------	------------------------------------	----------------



6 Volt Head, & Clear Rear Lamp (Can be used as 12 Volt by Changing Bulb)

Minneapolis Moline

Replaces: #JT1360, JT1361, 10A2027
Fits: GTA, GTB, GTC, R, RTE, RTN, RTS, RTU, U, UTC, UTE, UTN, UTS, Z, ZA, ZAS, ZAU, Early ZT

PARTS FOR LIGHT ABOVE

Headlamp & Parts are interchangeable with original except as noted

B9017-002	7" Lens With Guide Name	\$21.99
B9017-003	7" Clamp Ring	\$17.99
B9017-005	7" Gasket	\$8.99
B9017-006	7" Reflector *Call for Availability*	\$16.50
B9017-067	7" Light Terminal	\$6.00
B9017-013	6 Volt Bulb <i>Fits Above Reflector, Not Original</i>	\$3.00
	Pack of 10	\$25.50
B9017-015	12 Volt Bulb <i>Fits Above Reflector, Not Original</i>	\$3.00
	Pack of 10	\$25.50

B9016-004	12 Volt Sealed Beam Head Light	\$49.99
------------------	---------------------------------------	----------------



Minneapolis Moline
Replaces: #10A7568

B9016-006	Bullet Type Head Lamp	\$57.99
------------------	------------------------------	----------------



6 Volt Head, & clear rear lamp (can be used as 12 volt by changing bulb)

Minneapolis Moline

Replaces: #10A14458, 10A7412
Fits: 4 Star, 4 Star Super, 5 Star, Big Mo 400, Big Mo 500, Big Mo 600, JetStar, 445 (Note: This is a bulb style light. The

original was a sealed beam style. Listed related components are for this light, not the original.)

PARTS FOR LIGHT ABOVE

B9017-056	4 3/4" Lens with Guide Name	\$14.99
B9017-057	4 3/4" Clamp Ring (Black)	\$15.99
B9017-058	4 3/4" Gasket	\$3.99
B9017-004	4 3/4" Reflector	\$14.99
B9017-067	4 3/4" Light Terminal	\$6.00
B9017-013	6 Volt Bulb	\$3.00
	Pack of 10	\$25.50
B9017-015	12 Volt Bulb	\$3.00
	Pack of 10	\$25.50
B9017-031	Sealed Beam, 12 Volt High Beam	\$18.99
B9017-032	Sealed Beam, 12 Volt Low Beam	\$16.50



4 1/2" diameter
Minneapolis Moline
335, 445, & Tractors with Flat Top Fenders

Sealed Beam Head Lamp Assembly for Flat Top Fenders

B9016-022	12 Volt Low Beam	\$39.99
B9016-023	12 Volt High Beam	\$59.75
B9016-080	12 Volt LED Trapezoid	\$67.99
B9016-081	12 Volt LED Flood Light	\$67.99





Minneapolis Moline
Replaces: #30-3068242, 10A20255, 10A20258
Fits: A4T1400, A4T1600, G1000, G1050, G1350, G1355, G750, G850, G900, G950, M670, M670 Super, U302, 1865

PARTS FOR LIGHT ABOVE

B9017-031	Sealed Beam, 12 Volt High Beam	\$18.99
B9017-032	Sealed Beam, 12 Volt Low Beam	\$16.50
	4 1/2" diameter Minneapolis Moline Fits: 320, 330, 420 (Serial #100,001 & Up), 430, 440	





	B9017-009	\$5.99
	Concave Light Mounting Washer/Retainer	

B9016-075	12 Volt Sealed Beam Combo Tail Light Assembly	\$116.95
	4 3/4 diameter Minneapolis Moline Replaces: 10A15410 Fits: JetStar 2, M604, M5, M504, M602, Jetstar 3 Super	

B9016-054	Round Fender & Cab Mount Warning Light	\$19.99
	Restoration Quality 12 Volt Round Light with 2 x 4" Diameter Amber Lenses, Double Contact Bulb, 1/2" Diameter Stud, & 2.4" Thick at Widest Point. Minneapolis Moline Replaces: #10A26292, 164177AS, 30-3390705 Fits: A4T, G1000, G1050, G1350, G1355, G900, G955, M670, M670 Super, U302, Vista, 1865, 3 Star Super	

PARTS FOR LIGHT ABOVE		
B9017-069	Sealed Beam, 12 Volt Bulb	\$19.99
	Combination Rear Lamp w/ transparent red background using separate bulb Replaces: 10P1729, 10P2646, 20-7000652	

B9016-055	Rectangular Fender & Cab Mount Warning Light	\$32.99
	Restoration Quality 12 Volt Rectangular Light One Red and One Amber Lens With Amber Side Marker 4.5" Wide & 1/2" Diameter Stud Minneapolis Moline Fits: Various Models	

B9017-115	LED Combination Rear Light Bulb, Red/White, Sealed Beam	\$49.99
	Flood Pattern, 18 Watts, 1200 Lumens, Can Be Switched to White or Red Light Minneapolis Moline Replaces: 10P1729, 10P2646, 20-700065 Fits 4 1/2" O.D. Housing with Either Metal or Rubber Bezel	

Bullet Type Galvanized Steel 5 3/4" Headlight/ Work Lamp		
B9016-045	6 Volt Headlight	\$85.99
B9016-046	12 Volt Headlight	\$85.99
	Minneapolis Moline Replaces: KT1360, 10A3750 Fits: GB, GBD, UB, UTS (Gas: SN: 1214126 & up and Diesel: SN: 5002105 & up), ZAS (SN: 701911 & Up, When converted to 12 volt), [ZB, ZBE, ZBN, ZBU (When converted to 12 volt)]	

B9017-097	12-Volt LED Lamp, Trapezoid Beam Pattern	\$49.99
	Minneapolis Moline Replaces: #10P1553, 10P1701 Fits: 3 Star, 4 Star, 4 Star Super, A4T, A4T-1400, A4T-1600, Big Mo 400, Big Mo 500 (Diesel, (up to SN: 17800065), Big Mo 500 (Gas, (up to SN: 16800160), G705, G706, G950, G955, G1000, G1050, G1350, G1355, GVI, JetStar, JetStar 3, Jetstar 3 Super, M5, M602, M604, M670, M670 Super	

PARTS FOR LIGHT ABOVE		
B9017-071	5 3/4" Lens with Guide Name	\$34.99
B9017-072	5 3/4" Clamp Ring	\$27.99
B9017-073	5 3/4" Gasket	\$4.99
B9017-075	5 3/4" Reflector	\$29.99
B9017-013	6 Volt Bulb	\$3.00
	Pack of 10	\$25.50
B9017-015	12 Volt Bulb	\$3.00
	Pack of 10	\$25.50

B9017-098	12-Volt LED Lamp, Flood Beam Pattern	\$49.99
	Minneapolis Moline Replaces: #10P2645 GE: #4410, 4411 Fits: G1000, G1000 Vista, G1050, G1350, G1355, G550, G707, G708, G750, G850, G900, G940, G950, G955, JetStar 3, Jetstar 3 Super, M670, M670 Super, U302, U302 Super	

Bullet Tail Light, Black		
B9016-074	12 Volt	\$44.99
	Restoration Quality 12 Volt Black Rear Lamp with 2 1/8" O.D. Red Glass Lens Includes 12 Volt lamp Minneapolis Moline Fits: 335, 445, 4 Star, 5 Star, JetStar, Big Mo 400, Big Mo 500, Big Mo 600 Replaces: #10A7579, 10A7580	



DASH LAMPS

B9016-013	Chrome Finish Dash Lamp	\$19.75
	6 or 12 Volt, Chrome Finished Dash Lamp. Bulb not included. 6 Volt Use Bulb #B9017-046 12 Volt Use Bulb #B9017-049 Minneapolis Moline Replaces:- JT1380B, JT1380A Fits: R, RTE, RTN, RTS, RTU, U, UT, UTC, UTE, UTS (Early), Z, ZA (Early), ZAE, ZAN, ZAS, ZAU	

B9016-014	Black Finish Dash Lamp	\$19.75
	6 or 12 Volt, Black Finished Dash Lamp. Bulb not included. 6 Volt Use Bulb #B9017-046 12 Volt Use Bulb #B9017-049 Minneapolis Moline Replaces:JT1380B, JT1380A Fits: R, RTE, RTN, RTS, RTU, U, UT, UTC, UTE, UTS (Early), Z, ZA (Early), ZAE, ZAN, ZAS, ZAU	

Black Finish Dash Lamp		
B9016-042	12Volt	\$32.99
B9016-056	6 Volt	\$32.99
	6 or 12 Volt, Black Finished Dash Lamp. Bulb not Included. Stand-alone bulbs #B9017-046 & #B9017-049 are Fitted for this part. Replaces: Minneapolis Moline - Complete Light: 10A3902, Cover Only: 10P612 Fits: Minneapolis Moline - [G705, G706, G708, GB, GBD, GBLP, GVI, JetStar 2, JetStar 3, JetStar 3 Super, M5, M602, M604, M670, UB, UBE, UBED, UBN, UBND, UBU, UBUD, ZAS, ZBE, ZBN, ZBU (Following Models Using 2 Screw Style Dash Light)], [UTDS, UTS, Z, ZB (Late Models Using 2 Screw Style Dash Light)]	

Light Bulbs

B9017-046	6 Volt Bulb	\$1.25
B9017-049	12 Volt Bulb	\$1.25
	Light bulbs for products #B9016-013, #B9016-014, #B9016-042, #B9016-056	
B9017-036	6-Volt Sealed Beam Bulb	\$14.50
	30-Watt, Double Contact, 4.5" Diameter, Low Beam Minneapolis Moline Replaces: GE #4511 Fits: 335 (w/ 6-volt system)	

AUXILIARY PLUG & SOCKET

B9032-001	2 Pole Auxiliary Plug	\$23.75
	Minneapolis Moline Replaces: JT1380A, JT1380B Fits: GTA, GTB, GTC, R, RTE, RTN, RTS, RTU, U, UT, UTC, UTE, UTS (EARLY), Z, ZA (Early), ZAE, ZAN, ZAS, ZAU	

B9032-002	2 Pole Auxiliary Connector	\$19.75
	(Used With B9032-001) Minneapolis Moline Replaces: JT1380A, JT1380B Fits: GTA, GTB, GTC, R, RTE, RTN, RTS, RTU, U, UT, UTC, UTE, UTS (EARLY), Z, ZA (Early), ZAE, ZAN, ZAS, ZAU	

CIGARETTE LIGHTERS

B9030-001	6 Volt Cigarette Lighter	\$29.99
	With Anodized Aluminum Knob Engraved with the word Lighter Minneapolis Moline Replaces: #10A7578 Fits: 335 (Gas, with 6 Volt Systems)	

CARBURETOR REBUILD KITS

B9022-028	Marvel-Schebler Carburetor TRX Rebuild Kit	\$37.99
Minneapolis Moline Tractors Model R (up to engine number 402200), G4 Harvester, NTX Prime Mover (aka Industrial Jeep), RT (up to engine number 402200), Z (Early), ZT (Early) Marvel-Schebler Carburetor: #TRX12, TRX22, TRX27, TRX29, TRX30, TRX31, TRX36, TRX49 Minneapolis-Moline Carburetor: #EE733		

B9022-003	Marvel-Schebler Carburetor Rebuild Kit	\$24.99
	Minneapolis Moline Tractors Model 550, Five Star, G, G-4, G-6, GB, GTA, GTB, M5, M504, M602, M604, M670, U, UT Fits Carburetor: Marvel-Schebler Carburetor: #TSX-67, TSX-68, TSX-624, TSX-625, TSXU-838, TSXU-839 Minneapolis-Moline Carburetor: #10A-6268, 10A-6269, 10A- 10055, KE-817P, LE-806	

B9022-005	Marvel-Schebler Carburetor Rebuild Kit	\$23.99
 <p>Minneapolis Moline Tractors Model G, G-4, G-6, GB, GTA, GTB, 335, 445, 4 Star, 4 Star Super, 5 Star, Big Mo 400, Big Mo 500, 550, Big Mo 600, JetStar, JetStar 3, Jetstar 3 Super, KT, M5, M504, M602, M604, M670, Power Units, U, UT, U302, Z, ZA, ZAE, ZAI, ZAN, ZAS, ZAU, ZB, ZBE, ZBN, ZBU, ZT, ZTE, ZTI, ZTN, ZTS, ZTU</p> <p>Fits Carburetor: Marvel-Schebler Carburetor: TSX1001, TSX1002, TSX181, TSX221, TSX245, TSX296, TSX332, TSX360, TSX374, TSX397, TSX413, TSX414, TSX436, TSX464, TSX466, TSX475, TSX492, TSX505, TSX506, TSX506A, TSX526, TSX528, TSX530, TSX561, TSX562, TSX563, TSX575, TSX582, TSX592, TSX596, TSX602, TSX605, TSX606, TSX610, TSX615, TSX633, TSX639, TSX641, TSX645, TSX648, TSX662, TSX678, TSX688, TSX689, TSX695, TSX704, TSX711, TSX713, TSX719, TSX721, TSX725, TSX732, TSX737, TSX738, TSX755, TSX756, TSX757, TSX759, TSX768, TSX769, TSX772, TSX773, TSX775, TSX777, TSX784, TSX788, TSX791, TSX792, TSX797, TSX798, TSX799, TSX800, TSX801, TSX806, TSX808, TSX810, TSX811, TSX813, TSX814, TSX816, TSX819, TSX825, TSX836, TSX843, TSX849, TSX853, TSX854, TSX856, TSX857, TSX867, TSX869, TSX871, TSX877, TSX878, TSX881, TSX883, TSX884, TSX885, TSX886, TSX888, TSX889, TSX892, TSX892S, TSX893, TSX894, TSX895, TSX897, TSX898, TSX899, TSX900, TSX902, TSX903, TSX904, TSX904SL, TSX905, TSX905-1, TSX905SL, TSX906, TSX906SL, TSX907, TSX907SL, TSX908, TSX908SL, TSX911, TSX917, TSX920, TSX920SL, TSX921SL, TSX922, TSX922SL, TSX923, TSX923SL, TSX925, TSX927, TSX928, TSX932, TSX932SL, TSX933, TSX934, TSX934SL, TSX938, TSX938SL, TSX939, TSX940, TSX940SL, TSX941, TSX941SL, TSX942, TSX943, TSX944SL, TSX945SL, TSX946, TSX947SL, TSX949, TSX950, TSX952, TSX952SL, TSX955, TSX959, TSX959SL, TSX961, TSX961SL, TSX962, TSX962SL, TSX964SL, TSX965SL, TSX966, TSX967SL, TSX968SL, TSX97, TSX972, TSX973, TSX974, TSX974SL, TSX975, TSX975SL, TSX977, TSX980, TSX980SL, TSX984SL, TSX985, TSX985SL, TSX988, TSX989, TSX993, TSX994, TSX997, TSX998, TSX999, TSXU1006, TSXU1007, TSXU835, TSXU836, TSXU840, TSXU904, TSXU904SL, TSXU905, TSXU905-1, TSXU944SL, TSXU963, TSXU9631, TSXU995</p> <p>Replaces: Minneapolis Moline - 10A11452, 10A11452, 10A15430, 10A15430, 10A15562, 10A16902, 10A18173, 10A18173, 10A23732, 10A524, 10A6464, 10A6464, RE733C, RE733C, 10A1329, 10A2944, EE733, EE733A</p>		

B9022-023	Marvel-Schebler Carburetor Rebuild Kit	\$24.50
 <p>Minneapolis Moline Tractor Model 13, 145, 335, BF, BFH, BG, BIG, R, RTE, RTI, RTN, RTS, RTU, [Z, ZT, ZTE, ZTI, ZTN, ZTS, ZTU (Late)]</p> <p>Fits Carburetor: Marvel-Schebler Carburetor: #1004SL, TSX101, TSX102, TSX103, TSX112, TSX113, TSX114, TSX119, TSX120, TSX126, TSX128, TSX13, TSX132, TSX132A, TSX133, TSX134, TSX136, TSX137, TSX138, TSX140, TSX141, TSX142, TSX144, TSX146, TSX147, TSX148, TSX150, TSX151, TSX154, TSX155, TSX156, TSX157, TSX159, TSX161, TSX167, TSX171, TSX173, TSX179, TSX180, TSX182, TSX183, TSX184, TSX186, TSX188, TSX189, TSX190, TSX191, TSX192, TSX193, TSX194, TSX197, TSX198, TSX202, TSX203, TSX206, TSX206-1, TSX211, TSX212, TSX225, TSX228, TSX231, TSX237,</p>		

<p>TSX239, TSX239-1, TSX240, TSX241A, TSX241B, TSX241C, TSX246, TSX248, TSX253, TSX254, TSX258, TSX260, TSX264, TSX266, TSX267, TSX269, TSX272, TSX274, TSX278, TSX28, TSX280, TSX286, TSX287, TSX288, TSX289, TSX29, TSX290, TSX297, TSX30, TSX301, TSX305, TSX306, TSX308, TSX309, TSX312, TSX314, TSX315, TSX319, TSX322, TSX323, TSX326, TSX328, TSX33, TSX330, TSX331, TSX332, TSX333, TSX334, TSX335, TSX338, TSX339, TSX34, TSX341, TSX346, TSX347, TSX348, TSX35, TSX351, TSX352, TSX356, TSX357, TSX358, TSX359, TSX36, TSX361, TSX361-A, TSX363, TSX366, TSX367, TSX368, TSX37, TSX370, TSX370-1, TSX377, TSX38, TSX380, TSX388, TSX389, TSX39, TSX391, TSX398, TSX400, TSX403, TSX405, TSX406, TSX407, TSX409, TSX418, TSX419, TSX42, TSX420, TSX421, TSX422, TSX423, TSX428, TSX43, TSX44, TSX443, TSX447, TSX448, TSX45, ...TSX450, TSX452, TSX453, TSX455, TSX458, TSX459, TSX465, TSX470, TSX472, TSX474, TSX48, TSX480, TSX481, TSX484, TSX486, TSX49, TSX497, TSX500, TSX507, TSX510, TSX513, TSX514, TSX516, TSX518, TSX520, TSX525, TSX531, TSX532, TSX534, TSX539, TSX54, TSX541, TSX55, TSX551, TSX552, TSX556, TSX558, TSX560, TSX567, TSX569, TSX570, TSX573, TSX577, TSX58, TSX580, TSX589, TSX59, TSX593, TSX595, TSX597, TSX60, TSX603, TSX605, TSX606, TSX611, TSX614, TSX618, TSX626, TSX633, TSX635, TSX643, TSX646, TSX649, TSX649-1, TSX650, TSX653, TSX655, TSX656, TSX660, TSX663, TSX665, TSX668, TSX670, TSX671, TSX676, TSX680, TSX681, TSX683, TSX69, TSX690, TSX691, TSX692, TSX694, TSX696, TSX701, TSX706, TSX709, TSX710, TSX714, TSX730, TSX736, TSX74, TSX742, TSX744, TSX748, TSX753, TSX76, TSX762, TSX765, TSX767, TSX770, TSX771, TSX776, TSX776-1, TSX78, TSX781, TSX787, TSX79, TSX793, TSX796, TSX80, TSX802, TSX803, TSX804, TSX809, TSX812, TSX815, TSX820, TSX826, TSX827, TSX83, TSX830, TSX841, TSX844, TSX85, TSX851, TSX855, TSX857, TSX860, TSX862, TSX864, TSX865, TSX866, TSX879, TSX88, TSX882, TSX89, TSX896, TSX896SL, TSX90, TSX901, TSX91, TSX912, TSX913, TSX914, TSX919, TSX926, TSX930, TSX931, TSX936, TSX936SL, TSX937, TSX937SL, TSX94, TSX948, TSX949, TSX95, TSX954, TSX957, TSX957SL, TSX95A, TSX96, TSX971, TSX976, TSX978, TSX979, TSX979-1, TSX98, TSX983, TSX986, TSX987, TSX99, TSX990, TSX991, TSX991-1, TSX996, TSXU828, TSXU829, TSXU830, TSXU831, TSXU832, TSXU833, TSXU834, 1003</p> <p>Minneapolis Moline Carburetor: #120320, 135119, 10A-1320, 10A1329, 10A2944, 10A-8838, 10A-11451, EE733, EE733A</p>

CARBURETOR FLOATS

B9023-003	Marvel-Schebler Carburetor Float	\$12.75
 <p>Minneapolis Moline Tractors Model B, BFH, BG, R, RT, 13,145, 335</p> <p>Fits Carburetor: Marvel-Schebler Carburetor: #TSX-30, TSX-36, TSX-231, TSX-400, TSX-421, TSX-497, TSX-650, TSX-714, TSXU-829, TSXU-831, TSXU-833, TSXU-834</p> <p>Minneapolis Moline Carburetor: #120320, 135119, 10A-1320, 10A-2944, 10A-8838, 10A-11451, EE-733, EE-733-A</p> <p>Replaces: Marvel Schebler: #30-600</p>		

B9023-004	Marvel-Schebler Carburetor Float	\$19.95
	<p>Minneapolis Moline Tractors Model G, G-4, G-6, GB, GTA, GTB, KT, MT, M-4, M-5, M-670, Z, ZA, ZT, 445, JetStar, 4 STAR, Montrac, Unitrac Fits Carburetor: Replaces: Minneapolis Moline: #KS7905 Marvel-Schebler Carburetor: #TSX-97, TSX-360, TSX-633, TSX-713, TSX-797, TSX-878, TSXU-836, TSXU-963 Minneapolis Moline Carburetor: #10A-524, 10A-6464, 10A-11452, 10A-15430, 10A-18173, RE-733C</p>	

B9023-012	Marvel-Schebler Carburetor Float	\$29.50
	<p>Minneapolis Moline Tractors Model G, G-4, G-6, GB, GTA, GTB, U, UT, 550, FIVE STAR, M5, M504, M602, M604, M670 Fits: Marvel-Schebler Carburetor: #TSX-67, TSX-68, TSX-624, TSX-625, TSXU-838 Minneapolis Moline Carburetor: #10A-6268, 10A-6269, 10A-10055, KE-817P, LE-806</p>	

B9023-015	Zenith Carburetor Float	\$24.99
	<p>Minneapolis Moline Tractors Model R, RT, RTE, RTI, RTN, RTS, RTU Replaces: Zenith: #C85-115, C85-115S Fits Carburetor: (various- see www.brillman.com)</p>	

CARBURETOR ACCESSORIES

B9038-003	Carburetor Elbow Fuel Line Fitting with Strainer	\$7.99
	<p>Elbow Fuel Line Fitting with strainer for IHC carburetors. 1/8" Pipe to 1/4" Flare. Works with Carter UT Series and Various Marvel-Schebler Carburetors. Fits: Minneapolis Moline - R, U, 335, 445, 4 STAR, 5 STAR, JETSTAR, JETSTAR 2, JETSTAR 3, ZA, ZB, M604, M670, M5, 2 STAR, A, BF, BIG MO 400, BIG MO 500, BIG MO 600, GBD, GG, GT, GTA, GTB, GTBD, GTC, HD220, HD605, HD800, M504, M602, M670 SUPER, RT, UB, UBD, UBE, UBED, UBN, UBD, UBU, UBUD, UDLX, UT, V, ZAE, ZAN, ZAS, ZAU, ZBE, ZBN, ZBU, ZTI, ZTN, ZTS, ZTU</p>	

B9038-007	2" Sediment Bowl Gasket	\$2.19
	<p>2" Outer Diameter, Bowl to Body; Fits a 1.28" Tall Glass Bowl Minneapolis Moline Replaces: 15P13 Fits (Gas Only w/ 1.280" long glass bowl): 335, 445, 3 Star, 4 Star, 5 Star, JetStar, JetStar 3, Big Mo 400, Big Mo 500, Big Mo 600, M5, M504, M602, M604, M670, U302, U302 Super (Serviceable for Gas when using B9036-001- replaces the pill bottle style): R, RT, U, UB, UDLX, UT, Z, ZA ZAE, ZAN, ZAS, ZAU, ZTI, ZTN, ZTS, ZTU</p>	

FUEL SEDIMENT BOWLS

B9036-001	Fuel Sediment Bowl	\$27.99
	<p>Has a 3/8" Pipe Inlet and a 1/8" Pipe Outlet. Bowl is 1.280" Long. Shallow Bowl has 90° Outlet Only. Minneapolis Moline Replaces: #10A7345 Fits: (Gas / DSL) - Big Mo 500, Big Mo 600, JetStar 3 (Gas Only) - JetStar, Jetstar 3 Super, M5, M504, M602, M604, M670, U302, U302 Super, 335, 3 Star, 445, 4 Star, 4 Star Super, 5 Star (Serviceable for Gas, replaces the pill bottle style) - R, RT, RTE, RTI, RTN, RTS, & RTU (SN: 404801 & up), U (up to SN: 544000), UT, UTC, UTE, UTI, UTS, & UTU (SN: 317401 & up), Z (SN: 571687 & up), ZA, ZAE, ZAN, ZAU, & ZAS (up to SN: 701910) ZTI, ZTN, ZTS, & ZTU (SN: 611512 & up)</p>	

B9036-002	Fuel Sediment Bowl	\$34.99
	<p>Has a 3/8" Pipe Inlet, 1/8" Pipe Outlet, and a 2.315" tall glass bowl Minneapolis Moline Replaces: 10A3809, FT404B Fits (Using 2.315 Long Glass Bowl): G Gas, GB Gas, GT, GTA, GTB, GTC Gas, G707 Dsl., G708 Dsl., R (up to SN: 404800), J, RTE (up to SN: 404800), RTN (up to SN: 404800), RTS (up to SN: 404800), RTU (up to SN: 404800), U (SN: 544001 & Up), UB Gas / Dsl., UB SPECIAL Gas / Dsl., UDLX, UT (up to SN: 317400), UTS, UTU (up to SN: 317400), Z (up to SN: 571686), ZAS (SN: 701911 & Up), ZB, ZBE, ZBN, ZBU, ZTU (up to SN: 611511)</p>	

Parts for Sediment Bowl Above

B9038-024	Connector w/ Female Fitting	\$8.99
B9038-008	2" Sediment Bowl Screen	\$3.99
B9038-012	Sediment Bowl Gasket	\$2.99

B9036-004	Sediment Bowl Assembly	\$34.99
	<p>Has a 2.315" long bowl with a 3/8" NPT fuel inlet and a 5/16" compression outlet. Includes one fuel line fitting for a 5/16" line. Minneapolis Moline Fits: M5/336-4A (gas)</p>	

FUEL SYSTEM ACCESSORIES

B9038-009	Fuel Cap	\$10.99
	<p>Chrome Plated, 2.7" Outside Diameter, 1.88" Overall Tab Length, .25" Tab Width Minneapolis Moline Replaces: 10A23649, 10A3354, 10A7344, 10A7658 Fits: 335, 445, 4-Star, 5-Star, Big Mo 400, Big Mo 500, Big Mo 600, G900, G1000 Vista, JetStar, JetStar 3, M5, M504, M602, M604, M670, M670 Super, U302, UB, UT (Serviceable): ZA, ZAE, ZAN, ZAS, ZAU, ZB, ZBE, ZBN, ZBU</p>	

MUSTANG

Skid Steer Loader

ELECTRONIC IGNITION CONVERSION KIT

Replaces Points & Condenser



Mustang 4 Cyl. 1700 with Ford Distributor #72TF12100
& Bosch # 0-231-170-028

B9600-095	12 Volt Negative Ground	\$147.45
------------------	-------------------------	-----------------

Did You Know?

Nuffield tractors were designed by H.E. Merritt, who had been involved in designing tanks during WWII.

NUFFIELD

SPARK PLUG WIRE SETS

Nuffield 4/25

4 Cyl. Tailored Spark Plug Wire Set

B1037-001	Original Type PVC Wire	\$23.75
B1037-001E	EPDM Wire	\$26.00

BATTERY CABLES



Our Battery Cables are made from the Proper Gauge Copper, as either **Black Cotton Braided Wire** or **PVC Wire** (whichever is correct for the application), using Soldered & Heat Sealed Brass or Copper Terminals.

Nuffield 460 Diesel

B2037-001	Positive Battery Cable	\$46.25
B2037-002	Negative Battery Cable	\$54.75
B2037-003	Battery To Battery Jumper Cable	\$31.75

WIRING HARNESSSES



Our Wire Harnesses are made with our **premium cotton braid and/or PVC wire**.

They have the **correct gauge, color, wire, & fuse holders** (if needed).

All terminals are **soldered according to the original**.

(Harnesses do not include Battery Cables & Spark Plug Wires; however, we can supply these as separate products.)

NO HIDDEN COSTS, NOTHING EXTRA TO BUY!

Nuffield 460 Diesel

B3037-001	Complete Wire Harness Original Design with Generator & Regulator	\$238.00
------------------	--	-----------------

OLIVER

TABLE OF CONTENTS

Spark Plug Wire Sets	362
Battery Cables	363
Wire Harnesses	365
Tune Up Parts (With Distributor)	370
Electronic Ignition Conversion Kits	371
Tune Up Parts (With Magneto)	372
Magnetos	374
Gauges	374
Switches	376
Starter Switches & Solenoids	377
Cutout Relays & Voltage Regulators	377
Brush Sets	378
Alternators	379
Identification Tags	379
Lights & Light Parts	379
Auxiliary Plugs & Sockets, Starter Switches	381
Carburetor Rebuild Kits	381
Carburetor Floats	383
Carburetor Accessories	383
Fuel Sediment Bowls	383

Oliver 55, Super 55, 550

4 Cyl. Tailored Spark Plug Wire Set

B1038-003	Original Type Cotton Braid Wire	\$23.75
B1038-003E	EPDM Wire	\$26.00
B1038-003S	Suppression Wire	\$26.00
B1038-003CS	Cotton Suppression Wire	\$40.75

Oliver 60

4 Cyl. Tailored Spark Plug Wire Set

B1038-005	Original Type Cotton Braid Wire	\$23.75
B1038-005E	EPDM Wire	\$26.00
B1038-005S	Suppression Wire	\$26.00
B1038-005CS	Cotton Suppression Wire	\$40.75

Oliver 66, Super 66

4 Cyl. Tailored Spark Plug Wire Set

B1038-006	Original Type Cotton Braid Wire	\$23.75
B1038-006E	EPDM Wire	\$26.00
B1038-006S	Suppression Wire	\$26.00
B1038-006CS	Cotton Suppression Wire	\$40.75

Oliver 70

with Magneto

6 Cyl. Tailored Spark Plug Wire Set

B1038-008	Original Type Cotton Braid Wire	\$43.25
B1038-008E	EPDM Wire	\$47.25

with Distributor

6 Cyl. Tailored Spark Plug Wire Set

B1038-024	Original Type Cotton Braid Wire	\$43.25
B1038-024E	EPDM Wire	\$47.25
B1038-024S	Suppression Wire	\$47.25
B1038-024CS	Cotton Suppression Wire	\$74.25

Oliver 77 Super

6 Cyl. Tailored Spark Plug Wire Set

B1038-009	Original Type Cotton Braid Wire	\$30.25
B1038-009E	EPDM Wire	\$33.00
B1038-009S	Suppression Wire	\$33.00
B1038-009CS	Cotton Suppression Wire	\$52.25

Oliver 80

Up to Serial #10,992

4 Cyl. Tailored Spark Plug Wire Set

B1038-025	Original Type Cotton Braid Wire	\$23.75
B1038-025E	EPDM Wire	\$26.00

Serial #10,993 & Up

4 Cyl. Tailored Spark Plug Wire Set

B1038-026	Original Type Cotton Braid Wire	\$23.75
B1038-026E	EPDM Wire	\$26.00

SPARK PLUG WIRE SETS

Our Spark Plug Wire Sets Come Fully Assembled with the Proper Type Wire & Terminals.

They are Custom Tailored to Look & Fit Like Original Factory Equipment.

Varieties include:

Cotton Braid Wire: Copper Core with a Cotton Jacket.

PVC Wire: Copper Core with a Rubber Jacket.

EPDM Wire (E): Hi Performance Premium Conductor with a Tinned Copper Core, EPDM Silicone Insulation, and a Rubber Jacket.

Suppression Wire (S): for Electronic Ignition and is Spiral Wound, Ultra Low-Ohm, with EPDM Silicone Insulation and a Rubber Jacket.

Cotton Braid Suppression Wire (CS): also for Electronic Ignition, as Suppression Wire, but has an additional layer of Cotton Braid & Lacquer to replicate the vintage look, as well..



Oliver 44, Super 44, 440

4 Cyl. Tailored Spark Plug Wire Set

B1038-001	Original Type Cotton Braid Wire	\$23.75
B1038-001E	EPDM Wire	\$26.00
B1038-001S	Suppression Wire	\$26.00
B1038-001CS	Cotton Suppression Wire	\$40.75

Oliver 88, Super 88

6 Cyl. Tailored Spark Plug Wire Set

B1038-010	Original Type Cotton Braid Wire	\$30.25
B1038-010E	EPDM Wire	\$33.00
B1038-010S	Suppression Wire	\$33.00
B1038-010CS	Cotton Suppression Wire	\$52.25

Oliver 99

4 Cyl. Tailored Spark Plug Wire Set
with Magneto

B1038-027	Original Type Cotton Braid Wire	\$23.75
------------------	---------------------------------	----------------

with Distributor

B1038-012	Original Type Cotton Braid Wire	\$23.75
B1038-012E	EPDM Wire	\$26.00
B1038-012S	Suppression Wire	\$26.00
B1038-012CS	Cotton Suppression Wire	\$40.75

Oliver 770

6 Cyl. Tailored Spark Plug Wire Set

B1038-015	Original Type PVC Wire	\$27.50
B1038-015E	EPDM Wire	\$33.00
B1038-015S	Suppression Wire	\$33.00

Oliver 880

6 Cyl. Tailored Spark Plug Wire Set

B1038-016	Original Type PVC Wire	\$27.50
B1038-016E	EPDM Wire	\$33.00
B1038-016S	Suppression Wire	\$33.00

Oliver 1550, 1555, 1600, 1650, 1655, 1700, 1755, 1800, 1850, 1855 Gas & LP

6 Cyl. Tailored Spark Plug Wire Set

B1038-017	Original Type PVC Wire	\$32.50
B1038-017E	EPDM Wire	\$39.25
B1038-017S	Suppression Wire	\$39.25

Oliver OC-3 with WICO C Magneto & Hercules Engine

4 Cyl. Tailored Spark Plug Wire Set

B1022-016	Original Type Cotton Braid Wire	\$34.00
------------------	---------------------------------	----------------

Oliver OC-6 with Waukehsa or Hercules Engine

6 Cyl. Tailored Spark Plug Wire Set

B1038-023	Original Type PVC Wire	\$32.50
B1038-023E	EPDM Wire	\$39.25

BATTERY CABLES



Our Battery Cables are made from the Proper Gauge Copper, as either Black Cotton Braided Wire or PVC Wire (whichever is correct for the application), using Soldered & Heat Sealed Brass or Copper Terminals.

Oliver 44 Gas

B2038-046	Negative Battery Cable	\$44.75
B2000-006	Positive Ground Strap	\$13.50
B2038-047	Switch to Starter Cable	\$37.25

Oliver Super 44 Gas

B2038-046	Negative Battery Cable	\$44.75
B2000-006	Positive Ground Strap	\$13.50
B2038-047	Switch to Starter Cable	\$37.25

Oliver 55 Gas

B2038-001	Negative Battery Cable	\$31.50
B2038-002	Positive Battery Cable	\$31.50

Oliver 55 Diesel

B2038-003	Negative Battery Cable	\$47.75
B2000-006	Positive Ground Strap	\$13.50
B2038-004	Switch to Starter Cable	\$34.75

Oliver 60 Row Crop

B2038-005	Negative Battery Cable	\$31.50
B2000-005	Positive Ground Strap	\$12.50
B2038-006	Switch to Starter Cable	\$47.00

Oliver 60 Standard

B2038-007	Negative Battery Cable	\$36.50
B2000-002	Positive Ground Strap	\$9.50
B2038-008	Switch to Starter Cable	\$44.75

Oliver 66 Gas, Super 66 Gas

B2038-009	Negative Battery Cable	\$28.50
B2000-006	Positive Ground Strap	\$13.50
B2038-010	Switch to Starter Cable	\$49.25

Oliver 66 Diesel

B2038-011	Negative Battery Cable	\$28.00
B2038-012	Positive Battery Cable	\$37.25
B2038-013	Switch to Starter Cable	\$60.00

Oliver Super 66 Diesel

B2038-014	Negative Battery Cable	\$28.00
B2038-015	Positive Battery Cable	\$37.25
B2038-016	Switch to Starter Cable	\$60.00

Oliver 70 (1935-1937)

B2038-017	Negative Battery Cable	\$23.50
B2038-018	Positive Battery Cable	\$23.50
B2038-019	Switch to Starter Cable	\$47.75

Oliver 70 (1938 & Up)

B2038-020	Negative Battery Cable	\$28.50
B2000-004	Positive Ground Strap	\$10.50
B2038-021	Switch to Starter Cable	\$49.25

Oliver 77

B2038-022	Negative Battery Cable	\$28.50
B2000-006	Positive Ground Strap	\$13.50
B2038-023	Switch to Starter Cable	\$49.25

Oliver 77 Diesel

B2038-024	Negative Battery Cable	\$28.00
B2038-025	Positive Battery Cable	\$37.25
B2038-026	Switch to Starter Cable	\$60.00

Oliver Super 77

B2038-027	Negative Battery Cable	\$27.00
B2000-006	Positive Ground Strap	\$13.50
B2038-028	Switch to Starter Cable	\$49.75

Oliver Super 77 Diesel

B2038-029	Negative Battery Cable	\$28.00
B2038-030	Positive Battery Cable	\$37.25
B2038-031	Switch to Starter Cable	\$60.00

Oliver 80

B2038-032	Negative Battery Cable	\$30.00
B2000-002	Positive Ground Strap	\$9.50
B2038-033	Switch to Starter Cable	\$46.25

Oliver 88 Gas

B2038-034	Negative Battery Cable	\$28.50
B2000-006	Positive Ground Strap	\$13.50
B2038-035	Switch to Starter Cable	\$52.00

Oliver 88 Diesel

B2038-036	Negative Battery Cable	\$28.00
B2038-037	Positive Battery Cable	\$37.50
B2038-038	Switch to Starter Cable	\$60.00

Oliver Super 88 Diesel

B2038-039	Negative Battery Cable	\$28.00
B2038-040	Positive Battery Cable	\$37.50
B2038-041	Switch to Starter Cable	\$60.00
B2038-086	Switch to Preheater/ Glow Plug Cable	\$44.75

Oliver 90

B2038-042	Negative Battery Cable	\$38.00
B2000-002	Positive Ground Strap	\$9.50
B2038-043	Switch to Starter Cable	\$47.00

Oliver 99

B2038-044	Negative Battery Cable	\$38.00
B2000-002	Positive Ground Strap	\$9.50
B2038-045	Switch to Starter Cable	\$47.00

Oliver 440 Gas

B2038-046	Negative Battery Cable	\$44.75
B2000-006	Positive Ground Strap	\$13.50
B2038-047	Switch to Starter Cable	\$37.25

Oliver 500

B2038-048	Negative Battery Cable	\$44.75
B2000-006	Positive Ground Strap	\$13.50

Oliver 550 Gas

B2038-049	Negative Battery Cable	\$28.50
B2000-006	Positive Ground Strap	\$13.50

Oliver 550 Diesel

B2038-051	Negative Battery Cable	\$57.25
B2000-006	Positive Ground Strap	\$13.50
B2038-087	Battery to Battery Jumper Cable	\$31.50

Oliver 660 Gas

B2038-052	Negative Battery Cable	\$40.00
B2000-006	Positive Ground Strap	\$13.50

Oliver 660 Diesel

B2038-053	Negative Battery Cable	\$28.75
B2038-054	Positive Battery Cable	\$32.00
B2038-055	Switch to Starter Cable	\$47.25

Oliver 770 Gas

B2038-056	Negative Battery Cable	\$39.00
B2000-007	Positive Ground Strap	\$14.50

Oliver 770 Diesel

B2038-057	Negative Battery Cable	\$28.75
B2038-058	Positive Battery Cable	\$32.00
B2038-059	Switch to Starter Cable	\$47.25

Oliver 880 Gas

B2038-060	Negative Battery Cable	\$40.00
B2000-007	Positive Ground Strap	\$14.50

Oliver 880 Diesel

B2038-061	Negative Battery Cable	\$28.75
B2038-062	Positive Battery Cable	\$32.00
B2038-063	Switch to Starter Cable	\$47.25

Oliver 900 Gas

B2038-064	Negative Battery Cable	\$43.75
B2000-002	Positive Ground Strap	\$9.50
B2038-065	Switch to Starter Cable	\$37.25

Oliver 1250 Gas

B2038-066	Negative Battery Cable	\$40.00
B2038-067	Positive Battery Cable	\$24.50

Oliver 1550 Gas

B2038-068	Negative Battery Cable	\$44.75
B2038-069	Positive Battery Cable	\$28.50

Oliver 1650 Gas

B2038-070	Negative Battery Cable	\$44.75
B2038-071	Positive Battery Cable	\$28.50

Oliver 1650 Diesel (Early)

B2038-072	Negative Battery Cable	\$51.50
B2038-073	Positive Battery Cable	\$31.75

Oliver 1650 Diesel (Late)

B2038-074	Negative Battery Cable	\$51.50
B2038-075	Positive Battery Cable	\$26.50

Oliver 1750 Diesel

B2038-076	Negative Battery Cable	\$57.25
B2038-077	Positive Battery Cable	\$34.75

Oliver 1800 Gas

B2038-078	Negative Battery Cable	\$40.00
B2038-079	Positive Battery Cable	\$24.50

Oliver 1800 Diesel

B2038-080	Negative Battery Cable	\$57.25
B2038-081	Positive Battery Cable	\$32.00

Oliver 1850 Gas

B2038-082	Negative Battery Cable	\$44.75
B2038-083	Positive Battery Cable	\$28.50

Oliver 1850 Diesel

B2038-084	Negative Battery Cable	\$66.75
B2038-085	Positive Battery Cable	\$39.25



WIRING HARNESSSES

Our Wire Harnesses are made with our **premium cotton braid and/or PVC wire**. They have the **correct gauge, color, wire, & fuse holders** (if needed). All terminals are **soldered according to the original**. (Harnesses do not include Battery Cables & Spark Plug Wires; however, we can supply these as separate products.)
NO HIDDEN COSTS, NOTHING EXTRA TO BUY!

Oliver Super 44

B3038-001	Complete Wire Harness Original Design with Generator		\$163.75
------------------	--	--	-----------------

Oliver 55 Gas

Complete Wire Harness

B3038-002	Original Design		\$159.75
B3038-038	Modified for 1 Wire Alternator	With Kick Start	\$159.75

Oliver Super 55 Gas (Up to Serial #46,000)

Complete Wire Harness

B3038-002	Original Design with Generator	Early With Kick Start	\$159.75
B3038-038	Modified for 1 Wire Alternator	Early With Kick Start	\$159.75

Oliver Super 55 Gas (Serial #46,001 & Up)

Complete Wire Harness

B3038-028	Original Design with Generator	Late With Solonoid Start	\$200.75
B3038-042	Modified for a Delco 10SI Alternator (3-Wire Alternator)		\$200.75

Oliver 60

Complete Wire Harness

B3038-003	Original Design with Generator		\$151.50
B3038-041	Modified for a 1-Wire Alternator		\$151.50

Oliver 66 Gas

Complete Wire Harness

B3038-004	Original Design with Generator		\$180.25
B3038-022	Modified for a Delco 10SI Alternator (3-Wire Alternator)		\$180.25
B3038-039	Modified for a 1-Wire Alternator		\$180.25

Oliver Super 66 Gas

B3038-005	Complete Wire Harness Original Design with Generator		\$186.50
------------------	--	--	-----------------

Oliver 70

Complete Wire Harness

B3038-006	Original Design with Generator		\$159.75
B3038-026	Modified for 1 Wire Alternator		\$159.75

Oliver 77 Gas Row Crop (Up to Serial #344,801)

Complete Wire Harness

B3038-007	Original Design with Generator		\$186.50
B3038-025	Modified for 1 Wire Alternator		\$186.50
B3038-030	Modified for a Delco 10SI Alternator (3 Wire Alternator)		\$186.50

Oliver 77 Gas Row Crop (Serial #344,802 & Up)

Complete Wire Harness

B3038-019	Original Design with Generator		\$255.50
B3038-027	Modified for 1 Wire Alternator		\$255.50

Oliver Super 77 Gas

B3038-008	Complete Wire Harness Original Design with Generator		\$255.50
------------------	--	--	-----------------

Oliver 88 Gas Row Crop (Up to Serial #136,898)

Complete Wire Harness

B3038-007	Original Design with Generator		\$186.50
B3038-025	Modified for 1 Wire Alternator		\$186.50
B3038-030	Modified for a Delco 10SI Alternator (3 Wire Alternator)		\$186.50

Oliver 88 Gas Row Crop (Serial #136,899 & Up)

Complete Wire Harness

B3038-019	Original Design with Generator		\$255.50
B3038-027	Modified for 1 Wire Alternator		\$255.50

Oliver 88 Diesel

B3038-023	Complete Wire Harness Original Design With Generator		\$186.50
------------------	--	--	-----------------

Oliver Super 88 Gas

Complete Wire Harness

B3038-010	Original Design with Generator	Early with Push Button Start	\$186.50
B3038-043	Modified for a Delco 10SI (3-Wire) Alternator	Early with Push Button Start	\$186.50

Oliver 99

Complete Wire Harness

B3038-012	Original Design with Generator & Voltage Regulator		\$186.50
------------------	---	--	-----------------

Oliver 440

B3038-001	Complete Wire Harness Original Design with Generator		\$163.75
------------------	--	--	-----------------

Oliver 550 Gas

Complete Wire Harness

B3038-013	Original Design with Generator		\$210.00
B3038-029	Modified for a Delco 10SI Alternator (3 Wire Alternator)		\$210.00

Oliver 770 Gas (Up to Serial #156,793) with Clamshell Fender Lighting

Complete Wire Harness

B3038-014	Original Design with Generator		\$303.75
B3038-024	Modified for a Delco 10SI Alternator (3 Wire Alternator)	Can be used with 1 wire Alternator Except the "GEN" Indicator will not Work	\$303.75

Includes Listed Components Below and Can Be Purchased Separately

Dash & Engine Harness

B3038-031	Original Design with Generator		\$177.25
B3038-032	Modified for a Delco 10SI Alternator (3 Wire Alternator)		\$177.25
B3038-035	Lighting Harness Clamshell Fender Lighting		\$129.75

Oliver 770 Gas (Up to Serial #156,793) With Flat Top Fender Lighting

Complete Wire Harness

B3038-036	Original Design with Generator		\$303.75
B3038-037	Modified for a Delco 10SI Alternator (3 Wire Alternator)	Can be used with 1 wire Alternator Except the "GEN" Indicator will not Work	\$303.75

Includes Listed Components Below and Can Be Purchased Separately

Dash & Engine Harness

B3038-031	Original Design with Generator		\$177.25
B3038-032	Modified for a Delco 10SI Alternator (3 Wire Alternator)		\$177.25
B3038-034	Lighting Harness Flat Top Fender Lighting		\$129.75

Oliver 770 Gas (Serial #156,794 & Up) with Flat Top Fender Lighting

B3038-021	Complete Wire Harness Late with 10DN Alternator		\$357.50
------------------	---	--	-----------------

Includes Listed Components Below and Can Be Purchased Separately

B3038-033	Dash & Engine Harness Late with 10DN Alternator		\$229.75
B3038-034	Lighting Harness Flat Top Fender Lighting		\$129.75

Oliver 770 LP (Up to Serial #156,793) with Clamshell Fender Lighting

Complete Wire Harness

B3038-014	Original Design with Generator		\$303.75
B3038-024	Modified for a Delco 10SI Alternator (3 Wire Alternator)	Can be used with 1 wire Alternator Except the "GEN" Indicator will not Work	\$303.75

Includes Listed Components Below and Can Be Purchased Separately

Dash & Engine Harness

B3038-031	Original Design with Generator		\$177.25
B3038-032	Modified for a Delco 10SI Alternator (3 Wire Alternator)		\$177.25
B3038-035	Lighting Harness Clamshell Fender Lighting		\$129.75

Oliver 770 LP (Up to Serial #156,793) with Flat Top Fender Lighting

Complete Wire Harness

B3038-036	Original Design with Generator		\$303.75
B3038-037	Modified for a Delco 10SI Alternator (3 Wire Alternator)	Can be used with 1 wire Alternator Except the "GEN" Indicator will not Work	\$303.75

Includes Listed Components Below and Can Be Purchased Separately

Dash & Engine Harness

B3038-031	Original Design with Generator		\$177.25
B3038-032	Modified for a Delco 10SI Alternator (3 Wire Alternator)		\$177.25
B3038-034	Lighting Harness Flat Top Fender Lighting		\$129.75

Oliver 770 LP (Serial #156,794 & Up) with Flat Top Fender Lighting

B3038-021	Complete Wire Harness Late with 10DN Alternator		\$357.50
------------------	---	--	-----------------

Includes Listed Components Below and Can Be Purchased Separately

B3038-033	Dash & Engine Harness Late with 10DN Alternator		\$229.75
B3038-034	Lighting Harness Flat Top Fender Lighting		\$129.75

Oliver 880 Gas (Up to Serial #156,793) with Clamshell Fender Lighting

Complete Wire Harness

B3038-014	Original Design with Generator		\$303.75
B3038-024	Modified for a Delco 10SI Alternator (3 Wire Alternator)	Can be used with 1 wire Alternator Except the "GEN" Indicator will not Work	\$303.75

Includes Listed Components Below and Can Be Purchased Separately

Dash & Engine Harness

B3038-031	Original Design with Generator		\$177.25
B3038-032	Modified for a Delco 10SI Alternator (3 Wire Alternator)		\$177.25
B3038-035	Lighting Harness Clamshell Fender Lighting		\$129.75

Oliver 880 Gas (Up to Serial #156,793) with Flat Top Fender Lighting

Complete Wire Harness

B3038-036	Original Design with Generator		\$303.75
B3038-037	Modified for a Delco 10SI Alternator (3 Wire Alternator)	Can be used with 1 wire Alternator Except the "GEN" Indicator will not Work	\$303.75

Includes Listed Components Below and Can Be Purchased Separately

Dash & Engine Harness

B3038-031	Original Design with Generator		\$177.25
B3038-032	Modified for a Delco 10SI Alternator (3 Wire Alternator)		\$177.25
B3038-034	Lighting Harness Flat Top Fender Lighting		\$129.75

Oliver 880 Gas (Serial #156,794 & Up) with Flat Top Fender Lighting

B3038-021	Complete Wire Harness Late with 10DN Alternator		\$357.50
------------------	---	--	-----------------

Includes Listed Components Below and Can Be Purchased Separately

B3038-033	Dash & Engine Harness Late with 10DN Alternator		\$229.75
B3038-034	Lighting Harness Flat Top Fender Lighting		\$129.75

Oliver 880 LP (Up to Serial #156,793) with Clamshell Fender Lighting

Complete Wire Harness

B3038-014	Original Design with Generator		\$303.75
B3038-024	Modified for a Delco 10SI Alternator (3 Wire Alternator)	Can be used with 1 wire Alternator Except the "GEN" Indicator will not Work	\$303.75

Includes Listed Components Below and Can Be Purchased Separately

Dash & Engine Harness

B3038-031	Original Design with Generator		\$177.25
B3038-032	Modified for a Delco 10SI Alternator (3 Wire Alternator)		\$177.25
B3038-035	Lighting Harness Clamshell Fender Lighting		\$129.75

Oliver 880 LP (Up to Serial #156,793) with Flat Top Fender Lighting

Complete Wire Harness

B3038-036	Original Design with Generator		\$303.75
B3038-037	Modified for a Delco 10SI Alternator (3 Wire Alternator)	Can be used with 1 wire Alternator Except the "GEN" Indicator will not Work	\$303.75

Includes Listed Components Below and Can Be Purchased Separately

Dash & Engine Harness

B3038-031	Original Design with Generator		\$177.25
B3038-032	Modified for a Delco 10SI Alternator (3 Wire Alternator)		\$177.25
B3038-034	Lighting Harness Flat Top Fender Lighting		\$129.75

Oliver 880 LP (Serial #156,794 & Up) with Flat Top Fender Lighting

B3038-021	Complete Wire Harness Late with 10DN Alternator		\$357.50
------------------	---	--	-----------------

Includes Listed Components Below and Can Be Purchased Separately

B3038-033	Dash & Engine Harness Late with 10DN Alternator		\$229.75
B3038-034	Lighting Harness Flat Top Fender Lighting		\$129.75

Oliver OC6

B3038-018	Complete Wire Harness Original Type With Generator		\$186.50
------------------	--	--	-----------------

Note

When ordering, please specify **Year** or **Serial Number**, Magneto/Distributor, & Regulator/Cut Out Relay.
Some Harnesses were originally made with PVC Wire & Braided; others were made with PVC Wire & Taped.
In those cases, we build them the **Original Way..!**

TUNE UP PARTS WITH DISTRIBUTOR

Oliver 4 Cylinder Model #44, 55, 60, 66, 90, 99, Super 99, 440, 550. Also for Delco Distributor Conversion #1111411, 1111414, 1112555		
	B4100-001	\$10.50
	PCR Kit Includes: Points (#B4001-001), Condenser (#B4002-001), Rotor (#B4004-002) Replaces: Points - #D100HP, 1855720 Condenser - #1928111, D-203, 1869704, D-200 Rotor - #820445, D400	
	B4004-002	\$5.75
	Rotor Replaces: #820445, D400	
	B4003-001	\$13.50
	Distributor Cap Premium Grade, Made in the USA (Brass Contacts) Replaces: #811735, D300	
	B4006-001	\$9.99
	Dust Cover Replaces: #1900119	
	B4007-001	\$11.95
	Cap Clip Short Mount, 1 Used Replaces: #1889967, 1847289, 453844, 453461	
	B4007-002	\$11.95
	Cap Clip Long Mount, 1 Used Replaces: #1889967, 1889999, 453844, 453461	
	B4008-001	\$14.99
	Distributor Insulator Replaces: #1904376	
	B4009-001	\$25.99
	Distributor Bushing & Shim Kit	

*For 6- or 12-Volt Ignition Coils & Accessories, see p.44

Oliver 4 Cylinder with WICO Distributor #XB4100		
	B4011-004	\$17.75
	Points Replaces: #1-5008, 1-5111, FXH-2100B, FXH-2400B, X5996	
	B4002-004	\$11.00
	Condenser Replaces: #90-5072	
	B4013-004	\$36.75
	Cap Includes #B4016-004 Replaces: #3-5014	
	B4014-002	\$23.50
	Rotor Replaces: #4-5010	
	B4016-005	\$1.75
	Flange Gasket Replaces: #SAE	

Oliver 6 Cylinder with Delco Distributor, Model #OC-6, OC-12 (with Waukesha 185GA, 185GB, Hercules JXLD Engines), 70, 77, 88, 99, 99GMTC, 440, 550, 770, 880, 950, 990, 995		
	B4100-001	\$10.50
	PCR Kit Includes: Points (#B4001-001), Condenser (#B4002-001), Rotor (#B4004-002) Replaces: Points - #D100HP, 1855720 Condenser - #1928111, D-203, 1869704, D-200 Rotor - #820445, D400	
	B4004-002	\$5.75
	Rotor Replaces: #820445, D400	
	B4003-002	\$20.25
	Distributor Cap Premium Grade, Made in the USA (Brass Contacts) Replaces: #824735, D301	
	B4006-001	\$9.99
	Dust Cover Replaces: #1900119	

	B4007-001 Cap Clip Short Mount, 1 Used Replaces: #1889967, 1847289, 453844, 453461	\$11.95
	B4007-002 Cap Clip Long Mount, 1 Used Replaces: #1889967, 1889999, 453844, 453461	\$11.95
	B4008-007 Distributor Insulator	\$14.99
	B4009-001 Distributor Bushing & Shim Kit	\$25.99

*For 6- or 12-Volt Ignition Coils & Accessories, see p.44

Oliver



6 Cylinder Model #1500, 1555, 1650, 1655, 1750, 1755, 1850, 1855 with Holley Distributor #2563-1 & With Holley Distributor #2562-1

	B4001-010 Points Replaces: #FAA-12171A (DP-3), 7RA-12171 (DP-7)	\$4.75
	B4002-014 Condenser Replaces: #86D-139A, 86D-140A	\$7.50
	B4004-015 Rotor Premium Grade, Made in the USA Replaces: Holley #76D-475A, Oliver #16890A	\$6.75
	B4003-022 Distributor Cap Premium Grade, Made in the USA Replaces: Holley #34R-3753A, 30-62, Oliver #159746A, 161889A	\$24.75

*For 12-Volt Ignition Coils & Accessories, see p.44

Oliver 6 Cylinder Model 1600 & 1800 with Delco Distributor #1112632 Screw Down Cap

	B4100-003 PCR Kit Includes: Points (#B4001-012), Condenser (#B4002-012), Rotor (#B4004-013) Replaces: Points - #D108P Condenser - #D205 Rotor - #D-419R, 1963972	\$9.75
---	--	---------------

	B4004-013 Rotor Premium Grade, Made in the USA Replaces: #D-419R, 1963972	\$4.75
	B4003-021 Distributor Cap Replaces: #1954569, D-316	\$8.75
B4006-004	Dust Cover Replaces: #1960325	\$16.99

*For 12-Volt Ignition Coils & Accessories, see p.44

Replacement Distributors

1112587N	New Delco #1112587 Distributor	\$345.00
	Brand New Delco Distributor #1112587. Has tachometer cable connection. Fits: Oliver - 77, Super 77, 88, Super 88, 770, 880, 1550, 1555, 1600, 1650, 1655, 1750, 1755, 1800, 1850, 1855	
1112587R	Rebuilt Delco #1112587 Distributor	\$325.00 outright \$225.00 exchange with \$100 core
	Rebuilt Delco Distributor #1112587 Does <u>not</u> have tachometer cable connection. Fits: Oliver - 77, Super 77, 88, Super 88, 770, 880, 1550, 1555, 1600, 1650, 1655, 1750, 1755, 1800, 1850, 1855	

ELECTRONIC IGNITION CONVERSION KITS

Replaces Points & Condenser



Oliver 4 Cyl. Model #44, 55, 60, 66, 90, 99 Super 99, 440, 550

B9600-006	12 Volt Negative Ground	\$147.45
B9600-006P12	12 Volt Positive Ground	\$165.45
B9600-006P6	6 Volt Positive Ground	\$165.45

Oliver 6 Cyl. Model #70, 77, 88, 99 99GMTC, 440, 550, 770, 880, 950, 990, 995 with Delco Distributor

B9600-255LS	12 Volt Negative Ground	\$162.45
B9600-255LSP12	12 Volt Positive Ground	\$175.45
B9600-255LSP6	6 Volt Positive Ground	\$175.45

Oliver 6 Cyl. Model #1500, 1550, 1555, 1600, 1650, 1655, 1750, 1755, 1850, 1855 with Holley Distributor #2562-1 & #2563-1		
B9600-138A	12 Volt Negative Ground	\$235.95

Oliver 6 Cyl. Model #1500, 1550, 1555, 1600 1650, 1655, 1750, 1755, 1850, 1855 with Mallory YL Series Distributor		
B9600-166	12 Volt Negative Ground	\$134.45

Oliver 6 Cyl. Model 1600, & 1800 with Delco Distributor #1112632 Screw Down Cap		
B9600-014A	12 Volt Negative Ground	\$124.95
B9600-014AP12	12 Volt Positive Ground	\$139.95





For Ignition Coils & Accessories, see p.44

TUNE UP PARTS WITH MAGNETO

Oliver with Fairbanks-Morse Magnetos #FM-R6B, FM-XOR6B, FM-XR6B, FM-Z6B		
	B4014-017 Rotor Replaces: #Z2765	\$36.50
	B4013-036 Cap Replaces: #Q800 Includes Cap Brush	\$87.50

Oliver AG, E, G, GG, HG with WICO Magneto #C1113		
	B4110-002 PCR Kit Includes: Points (#B4011-012), Condenser (#B4012-006), Rotor (#B4014-005) Replaces: Points - #1-5084, FWM1256S Condenser - #2-5076, X5999, FXH2724S Rotor - #4-5000, FXH2408	\$45.25
	B4013-013 Cap Replaces: #3-5008	\$37.25
	B4014-005 Rotor Replaces: #4-5000, FXH2408	\$7.75

	B4013-011 Cap (Inner) Replaces: #94-5096, FXC2302A	\$49.75
	B4015-008 Coil Replaces: #X-2766, 5-5086	\$62.75
	B4016-008 Cap Gasket Replaces: #94-5085	\$1.50
	B4016-009 Complete Gasket Set Replaces: #90-5030	\$3.75
	B4017-007 Impulse Spring Replaces: #94-5016	\$12.50
	B4017-025 Bearing 2 Used Replaces: #24-5005	\$6.75
	B4016-005 Flange Gasket Replaces: #SAE	\$1.75
	B4017-057 WICO C Coil Bar	\$12.75
	B9013-010 WICO Series C Nameplate	\$7.00

Oliver AG, E, G, GG, HG, OC-3 with WICO Magneto #XH1113, 113B, XH1128		
	B4011-004 Points Replaces: #1-5008, 1-5111, FXH-2100B, FXH-2400B, X5996	\$17.75
	B4012-002 Condenser Replaces: #2-5007, X5614, X6916	\$13.75

	B4017-040 Condenser Clamp Replaces: #94-5167	\$2.75
	B4013-004 Cap Includes #B4016-004 Replaces: #3-5014	\$36.75
	B4014-002 Rotor Replaces: #4-5010	\$23.50
	B4016-004 Cap Gasket Replaces: #94-5076	\$2.25
	B4015-003 Coil (Hot Coil) Replaces: #5-5011, AR12006, FXH2403, X5700, X5700B, X5700C	\$39.75
	B4017-003 Coil Clamp 2 used, each sold separately Replaces: #94-5080	\$2.25
	B4017-004 Coil Bar Replaces: #94-5066	\$8.50
	B4017-005 Inner Bearing Replaces: #24-5000	\$3.50
	B4017-006 Outer Bearing Replaces: #25-5000	\$9.75
	B4017-046 Bearing Cage Snap Ring Replaces: #43-5055	\$2.75
	B4017-007 Impulse Spring Replaces: #94-5016	\$12.50

	B4017-008 Stop Button Assembly Includes #B4017-009 Replaces: #90-5042 For the version with a Ground Wire, use #B4017-063 (\$7.26) instead.	\$6.25
	B4017-009 Stop Button Replaces: #94-5079	\$2.25
	B4017-051 WICO Impulse Catch Plate Replaces: #94-5070, FXH-210S-1	\$10.25
	B4016-005 Flange Gasket Replaces: #SAE	\$1.75
	B9013-011 WICO Series X Nameplate Fits the WICO Series X magneto (Rivets included)	\$7.00

Oliver #70, 70HC, 70KD & All Row Crop 6 Cyl. with WICO Magneto #XH977

	B4011-004 Points Replaces: #1-5008, 1-5111, FXH-2100B, FXH-2400B, X5996	\$17.75
	B4012-002 Condenser Replaces: #2-5007, X5614, X6916	\$13.75
	B4017-040 Condenser Clamp Replaces: #94-5167	\$2.75
	B4013-014 Cap Replaces: #3-5015	\$55.75
	B4014-008 Rotor Replaces: #4-5004	\$30.00
	B4016-004 Cap Gasket Replaces: #94-5076	\$2.25
	B4015-003 Coil (Hot Coil) Replaces: #5-5011, AR12006, FXH2403, X5700, X5700B, X5700C	\$39.75

	B4017-003 Coil Clamp 2 used, each sold separately Replaces: #94-5080	\$2.25
	B4017-004 Coil Bar Replaces: #94-5066	\$8.50
	B4017-005 Inner Bearing Replaces: #24-5000	\$3.50
	B4017-006 Outer Bearing Replaces: #25-5000	\$9.75
	B4017-046 Bearing Cage Snap Ring Replaces: #43-5055	\$2.75
	B4017-007 Impulse Spring Replaces: #94-5016	\$12.50
	B4017-008 Stop Button Assembly Includes #B4017-009 For the version with a Ground Wire, use #B4017-063 (\$7.26) instead.	\$7.75
	B4017-009 Stop Button Replaces: #94-5079	\$2.25
	B4017-051 WICO Impulse Catch Plate Replaces: #94-5070, FXH-210S-1	\$10.25
	B4016-005 Flange Gasket Replaces: #SAE	\$1.75
	B4016-012 Striker Plate Gasket Replaces: #94-5154	\$2.25
	B9013-011 WICO Series X Nameplate Fits the WICO Series X magneto (Rivets included)	\$7.00

REPLACEMENT MAGNETOS

Rebuilt Magnetos

Our Rebuilt Magnetos are completely torn down, cleaned, & inspected. They will (at the minimum) have the following new parts: Points, Condenser, Coil, Coil Insulators, Lead-out Tower, & Outside Covers, plus any additional parts that are needed to make the unit look & perform like new.

They come with a 1-Year Limited Warranty.

Notes:

1. Unless otherwise specified, cost is exchange price.
2. A core charge (see below) will be charged to your credit card until we receive your good core.
3. A good core is considered a complete magneto with no cracks or weld repairs. Only good cores will be credited.

*Magnetos must be used with copper ignition wire.
Use of any other type will Void the Warranty.*

	XH1113R	Exchange	\$445.00
		Outright	\$645.00
Rebuilt WICO Magneto 4 Cyl. Flange Mount Core Charge: \$200			

GAUGES

Ammeters, Universal

B9025-002	Ammeter 20-0-20	\$19.99
	Has a black face with white lettering and a chrome bezel Does not have a logo Dimensions: Fits in 2" Diameter Hole 1.850" From Post to Bottom of Bezel	
B9025-005	Ammeter 30-0-30	\$19.99
	This Gauge has a chrome bezel. Oliver Fits: HG, OC-3, OC-6, OC-9, Super 44, Super 55, Super 66, Super 77, Super 88, Super 99, 60, 66, 70, 77, 80, 88, 90, 99, 440, 660, 900, 950, 990, 995	
B9025-008	Ammeter 60-0-60	\$19.99
	Has a black face with white lettering & a chrome bezel Uses threaded terminals and is dash mounted Used with 12-Volt Alternator Systems Dimensions: Fits in 2" Diameter Hole Measures 1.765" from Top of Post to Bottom of Bezel	

Ammeters, Oliver

B9025-046	Oliver Ammeter Gauge 20-0-20 (Yellow Face)	\$27.99
	<p>White Replaces: 720951A, 608747A, 1HA-7353</p> <p>Oliver Fits: HG, OC-3, OC-4, OC-6, Super 44, Super 55, 66, 77, Super 77, 88, Super 88, 99, Super 99 GM, 440, 660, 950, 990, 995 [60, 70, 80 (Will Fit But It Has A Different Face Color Than Original)]</p>	

Oil Pressure Gauges, Oliver

B9025-085	Oliver Instrument Cluster Gauge - Negative Ground	\$96.99
	<p>30 full to 250 empty OHM (fuel), Dash opening may need to be slightly enlarged, Gauge must be grounded to work properly- may have to run extra ground wire from threaded clamp terminal to existing bolt to attain a proper ground.</p> <p>Oliver Replaces: #101340A</p> <p>Fits: 550, 770, 880 (all Gas/ Diesel)</p>	

B9025-047	Oliver Oil Pressure Gauge (0-25PSI) Dash Mounted (Yellow Face)	\$27.99
	<p>White Replaces: 608744A, 7K344, 1HA-344A</p> <p>Oliver Fits Models: HG, OC-3, OC-4, OC-6, Super 44, Super 55, 66, Super 66, 77, Super 77, 88, Super 88, 99, Super 99, 550, 660 [60, 70, 80 (Will Fit But It Has A Different Face Color Than Original)]</p>	

Oil Pressure Gauges, Universal

B9025-004	Universal Oil Pressure Gauge (0-50 PSI)	\$21.99
	<p>Has 1/8" NPT Male Threads, studs, & a bracket. No logo included. Dash-mounted, requires a 2" diameter hole.</p> <p>Oliver Fits: HG, OC-3, OC-6, Super 44, Super 55, Super 66, Super 77, Super 88, Super 99, 60, 66, 70, 77, 80, 88, 90, 99, 440, 660, 900, 950, 990, 995, 1550, 1555, 1600, 1650, 1655, 1800, 1850, 1900, 1950</p>	

B9025-001	Universal Oil Pressure Gauge (0-80 PSI)	\$24.99
	<p>Has 1/8" NPT Male Threads, studs, & a bracket. No logo included. Dash-mounted, requires a 2" diameter hole.</p> <p>Oliver Fits: [1950T, 1550, 1555, 1600, 1650, 1655, 1750, 1755, 1800, 1850, 1855, 1865, 1870, 1900, 1950, 1955, 2050, 2055, 2150, 2155, 2255, 2270, 2655(& others using 80 Lb. Gauge)]</p>	

Oil Pressure Gauge, Line Kit

B9026-001	Oil Pressure Gauge Line Kit	\$29.99
	<p>6 FT copper 1/8" line --- Kit includes: (2) 5/16 - 24 UNF nut, (2) compression sleeves, (1) 1/8 - 27 NPTF female to 5/16" - 24 UNF male adapter --- Note: Depending on application customer may be required to purchase other fittings.</p>	

B9026-004	Oil Pressure Gauge 1/4" to 1/8" NPT Adapter Fitting	\$15.99
	<p>Adapter Fitting for Oil Gauges - 1/4" to 1/8" NPT.</p> <p>Oliver Fits: DG, Super 44, Super 55, Super 66, Super 77, Super 88, Super 99, 1550, 1555, 1600, 1650, 1655, 1750, 1755, 1800, 1850, 1855, 1900, 1950, 1950T, 1955, 2050, 2150, 2255, 440, 550, 60, 66, 660, 70, 77, 770, 80, 88, 880, 90, 950, 99, 990, 995, Cletrac: AD, AG, BG, BGS, DD, FD, FDE, FDLC, FG, Oliver: HGF, HGR, OC-13</p>	

Water Temperature Gauges,

Universal

B9025-006	Water Temperature Gauge	\$34.99
	<p>This Temperature Gauge Includes an Aluminum Sealing Washer to Seal Probe. It has a Chrome Bezel with White, Green, Red Zones on a Black Gauge Face. Has a 1/2" NPT Pipe Bushing and Probe Length of 1.279".</p> <p>Oliver</p> <p>Replaces: 100679A, 30-3485587</p> <p>Fits: [HG, OC-3, OC-4, Super 44, Super 55, Super 66, 440, 60, 66, 660, 80, 90, (And Other Models Using 60" Capillary Lead)]</p>	

B9025-007	Universal, Water Temperature Gauge	\$34.99
	<p>Dash-mounted (parts included), 72" long heavy duty capillary tube included (check length before ordering)</p> <p>Oliver</p> <p>Fits: [HG, OC-3, OC-4, OC-6, Super 44, Super 55, Super 66, Super 77, Super 88, Super 99, 440, 60, 66, 660, 70, 77, 80, 88, 90, 900, 950, 99, 990, 995 (And Others Using 72" Or Shorter Capillary Lead)]</p>	

Water Temperature Gauges, Oliver

B9025-048	Oliver Water Temperature Gauge	\$32.99
	<p>Oliver</p> <p>Replaces: 7A528B, A528B</p> <p>White</p> <p>Replaces: 608745A, 1K-528E, 1E-528</p> <p>Fits Models: HG, OC-3, OC-4, OC-6, Super 44, Super 55, Super 66, 77, Super 77, 88, Super 88, 99, Super 99, 440, 660 [60, 70, 80 (Will Fit But It Has A Different Face Color Than Original)]</p>	

Tachometer Drive Cables

B9026-003	56" Tachometer Drive Cable	\$34.99
	<p>Restoration Quality. Drive Cable for Tachometers. Measures 56" Outer Sheath Length. 5/8"-18 x 7/8"-18 Threads With Key On One End. Please Check Length Before Ordering.</p> <p>Oliver</p> <p>Fits: Super 77, Super 88, Super 99, [1550, 1555, 1600, 1650, 1655, 1850 (GAS)], 1750, 1800 (Gas / Diesel (Tach & Speedometer)), 1900 (4x4 GM Diesel (Speedometer Only)), 1950 (GM Diesel (Speedometer Only)), [770, 880 (Gas / Diesel)]</p> <p>Replaces: #104990, 720952AS</p>	

SWITCHES & KNOBS

Knobs

B5001-009	Combo Light Switch Knob	\$6.99
	<p>Fits #B9017-010, B9016-018, B9016-032, B9016-033. Also fits original equipment combo rear lights when 'handle' style knob is required.</p> <p>Oliver Fits: Super 55, Super 66, Super 77, Super 88, Super 99, 1550, 1600, 1650, 1655, 1750, 1800, 1850, 66, 660, 77, 770, 88, 880, 950, 99, 990, 995</p>	

Push/Pull Switches

B5002-001	2 Position Push/Pull Switch	\$7.75
	<p>OFF/ON Universal 2 Position Push/Pull (2 Screw Terminals) Mounting Stem 3/8"-32 Thread Knob #10/32 Thread</p>	

B5002-005	3-Position Push/ Pull Switch	\$29.75
	<p>Low Charge/High Charge/Lights (3 Position Switch) 3 Screw Type Mounting Stem .8" Thread Knob #10/32 Thread</p> <p>Premium Quality</p> <p>Made by the OEM Manufacturer</p>	

B5002-004	Heavy Duty Push/Pull Magneto Switch	\$8.25
	<p>ON/OFF (2 Position) Push/Pull Magneto Switch (2 Screw Terminals) Mounting Stem 3/8"-32 Thread Knob #10/32 Thread</p>	

Key Switches

B5003-001	2 Position Battery Key Switch	\$14.75
	<p>Universal OFF/ON 2 Position Key Switch (For Battery Ignition) (2 Screw Terminals) Mounting Stem 3/4"-20 Thread</p>	

B5003-005	4 Position Ignition Key Switch	\$39.99
	<p>Can replace the 4 terminal switch. 2 battery terminals, 5 Spade Terminals, OEM Style Delco Remy</p> <p>995" Diameter Threaded End. Includes 2 Keys & Jam Nut</p> <p>Replaces: #20-7101027, 721146A, 611064AS</p> <p>Oliver: K7354B, 100423ASA, 105232AS</p> <p>Fits: OC-4, Super 55 (SN 46001 & Up), Super 66, Super 77, Super 88, 550, 660, 770, 880, 950, 1550, 1555, 1600, 1650, 1655, 1750, 1755, 1800, 1850, 1855, 1900, 1950, 1955, 2150, 2255;</p> <p>White - Fits: 100, 140, 160, White: 2-105, 2-110, 2-135, 2-150, 2-155, 2-180, 2-70, 2-85, 2-88, 4-150, 4-175, 4-180, 4-210, 4-225, 4-270;</p>	

B5003-006	Ignition Key	\$4.99
	<p>Key For Above Part, #B5003-005. Brass Finish Fits Listed Models Using Delco Switch Oliver Replaces: #105678A, 72162639, 611105A Fits: OC-4, Super 55, Super 66, Super 77, Super 88, 140, 160, 550, 660, 770, 880, 950, 1550, 1555, 1600, 1650, 1655, 1750, 1755, 1800, 1850, 1855, 1900, 1950, 1955, 2150, 2255 White - Fits: White: 100, 2-105, 2-110, 2-135, 2-150, 2-155, 2-180, 2-70, 2-85, 2-88, 4-150, 4-175, 4-180, 4-210, 4-225, 4-270</p>	

B5003-008	Ignition Key Switch	\$24.99
	<p>Includes 2 Keys, 2 Spade Terminals Designed for 0.800" hole diameter. Oliver Replaces: #1K7354B Fits (with Start Button): 77, 88</p>	

COMBINATION SWITCHES

B5009-008	Serviceable Combination Switch	\$41.50
	<p>12 Volt, 30 Amp Combination Switch (6 Screw Type Terminals) Oliver Replaces: #1K7354A Fits: OC-6, Super 66, Super 77, Super 88, Super 99, 66, 77, 88</p>	

Momentary Switches

B5004-003	Momentary Push Switch	\$15.75
	<p>Manual Push Button Solenoid Switch with Rubber Protected Cap (2 Screw Terminals) Mounting Stem 5/8"-32 Thread Oliver Replaces: #105386A, 72160068, 7A7392, 1K7392A, 105386A, K7392A, 1K7392C Fits: [1950T, 1550, 1555, 1600, 1650, 1655, 1750, 1755, 1800, 1850, 1855, 1900, 1955, 2050, 2150, 2255, 2455, 2655 (Diesel Preheat switch)], [Super 99 GM, 995 (Starter Switch for Diesel)], 990 (Starter Switch), [Industrial: 660, 770, 880 (Horn Switch)] Oliver Miscellaneous - Fits: 2-62 (Backhoe, Not Field Boss, Preheater)</p>	

B5004-007	Neutral Safety Switch	\$29.99
	<p>Manual Push Button Safety Switch used as a Neutral Safety Switch. 2 Spade Terminals. 5/8"-32 Thread. 2.575" Total Length. For use as neutral safety switch. Oliver Fits: 1865, 2055, 2155, 2270, 2455, 2655 Replaces: #30-3138739</p>	

Starter Switches & Solenoids

B5007-004	12 Volt Solenoid	\$23.75
	<p>Has a Curved Bracket & 4 Terminals (Used with 30 & 35 MT Delco Starters) Fits: Oliver - [1950T, 770, 880 (Diesel with Starter # 1113088), 1550, 1600, 1650, 1750, 1755, 1850, 1855, 1955 (Diesel)], 77 (Diesel, (with starter 1119778)), 88 (Diesel (With Starter 1113075)) Replaces: Delco: #1119890, 1119912, 1119885, 1119877, 1119935, 1119882, 1119906, D953, D985, 1119833, 1119883, 1115537, 1119978, 1115582, 1119778, 1115508, 1115529, 1115540, 1115501</p>	

B5007-024	Delco 12 Volt Solenoid	\$109.50
	<p>12 Volt Rated Solenoid for Delco 40MT & 50MT Direct Drive Starters with 4 Terminals. Replaces: Delco - #1119835, 1119853, 1119862, 1119879, 1119895 Oliver - #30-3090892, 30-3370895 Fits: Oliver - 2255, 2270</p>	

CUTOUT RELAYS & VOLTAGE REGULATORS

Note: Due to modern battery design, voltage regulators can't be used to charge low or dead batteries. Doing so will destroy the voltage regulator and void the warranty.

B8001-001	6-Volt Cutout Relay	\$19.50
	<p>15 Amps, 6 Volt Works Positive or Negative Ground Replaces: Autolite - #CB4014, C4012(9-5), C4012(9-4), C4012(9-1), R40061 Delco - #266P, 266N, 265P, 265N, 5015850, 812970, 265J, 820845, 812971, 1116816, 265G, 265H, 1116755, 1116751, 1116809DR, 265B, 1842859, 265C, 1867781, 265F, 265D Oliver - #1116809 Fits: Oliver - 60, 70, [80, 90 (6 Volt)]</p>	

B8001-002	Electronic Cutout Relay	\$19.50
	<p>25 Amp, Works with 6, 12, or 24 Volts. & Positive or Negative Ground Replaces: Autolite - #CB4014, C4012(9-5), C4012(9-4), C4012(9-1), R40061 Delco - #266P, 266N, 265P, 265N, 5015850, 812970, 265J, 820845, 812971, 1116816, 265G, 265H, 1116755, 1116751, 1116809DR, 265B, 1842859, 265C, 1867781, 265F, 265D Oliver - #1116809 Fits: Oliver - 60, 70, [80, 90 (6 Volt)]</p>	

6-Volt Saddle Mounted Cutout Relay (Delco Version)		
B8001-004	Premium Quality, Made in the USA	\$122.50
B8001-006	Standard Quality	\$38.59
	Cutout Relay, 25 Amp, 6 Volt, Works Positive or Negative Ground. Replaces: Delco - #266P, 266N, 265P, 265N, 5015850, 812970, 265J, 820845, 812971, 1116816, 265G, 265H, 1116755, 1116751, 1116809DR, 265B, 1842859, 265C, 1867781, 265F, 265D Oliver - #1116809 Fits: Oliver - 60, 70, [80, 90 (6 Volt)]	

6-Volt Delco Type Voltage Regulator		
B8002-013	Premium Quality, USA Made	\$119.75
B8002-014	Standard Quality	\$34.75
	6 Volt, Positive Ground, 4 Terminals, Flat Mounting Bracket Replaces: Delco - #1116807, 1116816, 1118291, 1118308, 1118780, 1118982, 1119575, D645, D657 Prestolite - #8-291, GRX-291 Fits: Oliver - (6 Volt, Tractor Mounted) OC-3 with Hercules IXB	

6-Volt Delco Type Voltage Regulator		
B8002-011	Premium Quality, USA Made	\$124.75
B8002-012	Standard Quality	\$42.75
	6 Volt, 4 Terminals, Curved Mounting Bracket Regulator, Positive Ground Replaces: Delco - #1116766, 1118265, 1118305, 1118433, 1118436, 1118790, D641, D642, D643, D647, D660, D661 Fits: Oliver - OC-4, Super 44 (Gas), Super 77, Super 88, Super 99, 66, 77, 80, 88	

12-Volt Delco Type Voltage Regulator		
B8002-015	Premium Quality, USA Made	\$108.50
B8002-016	Standard Quality	\$34.75
	12 Volt, 4 Terminals, Curved Mounting Bracket/ Generator Mounted, Positive or Negative Ground Delco - #1118266, 1118306, 1118791, 1118983, 1118985, D644, D648 Briggs & Stratton Engines - #296028 Case - A21533, G44855 Fits: Oliver - CC12, OC4-3D, OC6, OC9, OC12 With Hercules Diesel, OC15, Super 55, 66, Super 66, 77, Super 77, 78, 88, Super 88, 99, Super 99, (Super 99GM, Super 99MTC (with Generator #1100316), 550, 770, 880, 950HC, 995, 1900	

12-Volt Delco Type Voltage Regulator		
B8002-017	Premium Quality, Made in the USA	\$99.75
B8002-018	Standard Quality	\$34.75
	12 Volt, 4 Terminals, Flat Mounting Bracket Regulator Tractor Mounted Fits: Oliver - 550, 770, 880, 1600, 1800 Replaces: Delco - #1118381, 1118779, 1118977, 1118987, 1118993, 1118997, 1118999, 1119576, D646 Prestolite - #8-290	

ALTERNATOR VOLTAGE REGULATORS

B8002-030	Alternator Voltage Regulator	\$14.50
	Heavy Duty, 12 Volt, Negative Ground Alternator Voltage Regulator. This external voltage regulator has 4 spade terminals (field, 2, 3, 4). It is designed for 'B' type circuits in negative ground systems. This is designed for use only in 12 volt systems. For Delco 10DN, & 20DN Fits: Oliver - Fits: 1950T, [770, 880 (SN #156837 & Up with Factory Alternator)], 1550, 1555, 1600, 1650, 1655, 1750, [1755, 1855, 2050 (With Factory Alternator)], 1850, 1955, 2050, 2150 Replaces: Oliver - #30-3001806, 166626A, 157651AS White - #158732AS, 20-7000409 Delco - #D630, D635, D663, 1119513, 1119515, 1119508, 1119519, D663, 1119502, 1119516, 1119506, 1119512, 1119515	

BRUSH SETS

X360	6 Volt, 3 Brush Generator Set	\$6.25
	Consisting of 3 Brushes Tractor Mounted Oliver Fits: OC-3 With Hercules IXB Engine	
X270	12 Volt, 2 Brush Generator Set	\$5.00
	Consisting of 2 Brushes Generator Mounted Oliver Fits: CC12, OC4-3D, OC9, OC12 With Hercules Diesel, OC15, Super 55, Super 66, Super 77, Super 88, 99, Super 99, (Super 99GM, Super 99 MTC with Generator #1100316), 550, 770, 880, 950HC, 995, 1900	
X348	12 Volt, 3 Brush Generator Set	\$6.00
	Consisting of 3 Brushes Tractor Mounted Oliver Fits: OC-6, 66, 77, 78, 88	

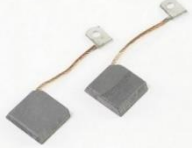
X270	12 Volt, 2 Brush Generator Set	\$5.00
		Consisting of 3 Brushes Tractor Mounted Oliver Fits: 550, 770, 880, 1600, 1800

B9013-005	Red Delco Remy I.D. Tag (Blank)	\$7.00
	Red Delco Remy I.D. Tag (Stamped)	\$14.25
		Red Delco-Remy I.D. Tag for 12 Volt Starters & 12 Volt Generators with Rivets, 3/4" 2 5/16"

ALTERNATORS

Delco 10SI Type

B6001-001	12 Volt Alternator (1 Wire)	\$112.75	
63 Amp, Low Cut In, Specially Built For Tractors, Forklifts, & Other Low Engine Speed Applications			
B6001-002	12 Volt Alternator (1 Wire/ 3 Wire)	\$118.75	
63 Amp, With 1 Wire Or 3 Wire For Warning Lamp On Automobiles & Trucks			
B6001-005	6 Volt Alternator (1 Wire, Positive Ground)	\$166.50	
6 Volt, 40 Amp Alternator with Positive Ground, 1 Wire, 3/8" pulley			
B6001-011	12 Volt Alternator (1 Wire)	\$129.75	
12 Volt, 63 Amp Alternator with Negative Ground, 1 Wire with Mechanical Tachometer Drive.			

Small ND Type

B6002-003	12 Volt Small Denso Alternator (1 Wire)	\$119.75
	This 40 Amp, 1 Wire Internal Regulator Alternator will Start Charging with a Much Lower Engine Speed Than Most Other Alternators! Comes with a 4 1/2" Housing Diameter, 3/8 To 1/2" Belt width & a 2 1/2" Pulley Diameter. Perfect for the Machine That Requires a Smaller Alternator. Excellent for Converting a 6 Volt System to 12 Volt. Available as Negative Ground Only & is Self-Excited	

IDENTIFICATION TAGS

B9013-004	Delco Remy I.D. Tag (Blank)	\$7.00
	Delco Remy I.D. Tag (Stamped)	\$14.25
		Black Delco-Remy I.D. Tag for Distributors, 6 Volt Starters, & 6 Volt Generators with Rivets, 3/4" 2 5/16"

LIGHTS & LIGHT PARTS

B9016-003	7" Flat Lens Type Head Lamp	\$99.99
		6 Volt Head, & Clear Rear Lamp (Can be used as 12 Volt by Changing Bulb) Oliver Replaces: #B7379D Fits: 60, 70, 80, 90, 99, 900

PARTS FOR LIGHT ABOVE

Headlamp & Parts are interchangeable with original except as noted

B9017-002	7" Lens With Guide Name	\$21.99
B9017-003	7" Clamp Ring	\$17.99
B9017-005	7" Gasket	\$8.99
B9017-006	7" Reflector *Call for Availability*	\$16.50
B9017-067	7" Light Terminal	\$6.00
B9017-013	6 Volt Bulb	\$3.00
	Fits Above Reflector, Not Original	
	Pack of 10	\$25.50
B9017-015	12 Volt Bulb	\$3.00
	Fits Above Reflector, Not Original	
	Pack of 10	\$25.50

Headlight Assembly

B9016-040	Bullet Type 6 Volt Head	\$53.99
B9016-041	Bullet Type 12 Volt Head	\$53.99
	Oliver Fits: HG (Cletrac), OC-3	

PARTS FOR LIGHT ABOVE

B9017-056	4 3/4" Lens with Guide Name	\$14.99
B9017-057	4 3/4" Clamp Ring (Black)	\$15.99
B9017-058	4 3/4" Gasket	\$3.99
B9017-004	4 3/4" Reflector	\$14.99
B9017-067	4 3/4" Light Terminal	\$6.00
B9017-013	6 Volt Bulb	\$3.00
	Pack of 10	\$25.50
B9017-015	12 Volt Bulb	\$3.00
	Pack of 10	\$25.50

B9016-004	12 Volt Sealed Beam Head Light	\$49.99
	Oliver Fits: 550 (Serial #60501 & Up), 660, 770, 880, (Serial #81629 & Up), 950, 990, 995 Replaces: #605404AS, 103429AS	

B9017-097	12-Volt LED Lamp, Trapezoid Beam Pattern	\$49.99
	Oliver Replaces: #103463A, 607525A Fits: 660, 770, 880, 950, 990, 995, 1550, 1555, 1600, 1650, 1655, 1750, 1755, 1800, 1850, 1855, 1865, 1870, 1900, 1950, 1950T, 1955, 2050, 2055, 2150, 2155, 2255, 2270, 2455, 2655	

PARTS FOR LIGHT ABOVE		
B9017-031	Sealed Beam, 12 Volt High Beam	\$18.99
B9017-032	Sealed Beam, 12 Volt Low Beam	\$16.50
B9017-036	Sealed Beam, 6 Volt Low Beam	\$14.50
	4 1/2" diameter Double Contact Light Bulb 4.365" Outside Diameter	

B9017-098	12-Volt LED Lamp, Flood Beam Pattern	\$49.99
	Oliver Replaces: #105774A, 166407A GE: #4410, 4411 Fits: 660 (Dsl. using 12 volt 4 1/2" diameter light), 950 (Sn: 81582 & up), 990 (Sn: 81582 & up), 995 (Sn: 81582 & up), 1265, 1270, 1365, 1370, 1465, 1470, 1550, 1555, 1600, 1650, 1655, 1750, 1755, 1800, 1800A, 1800B, 1800C, 1850, 1855, 1865, 1870, 1950, 1950T, 1955, 2050, 2055, 2150, 2155, 2255, 2270, 2455, 2655, 2-115, 2-78, 4-78	

Sealed Beam Head Lamp Assembly for Flat Top Fenders		
B9016-022	12 Volt Low Beam	\$39.99
B9016-023	12 Volt High Beam	\$59.75
B9016-080	12 Volt LED Trapezoid	\$67.99
B9016-081	12 Volt LED Flood Light	\$67.99
	Fits Oliver : 770, 880, 1550, 1555, 1600, 1650, 1655, 1750, 1755, 1800, 1850, 1855, 1900, 1950, 1955, 2050, 2150, 2255, 2655 White : 2-105, 2-135, 2-150, 2-155, 2-180, 2-70, 2-85, 4-150, 4-175, 4-210, 4-225, 4-270	

Bullet Type Galvanized Steel 5 3/4" Headlight/ Work Lamp		
B9016-045	6 Volt Headlight	\$85.99
B9016-046	12 Volt Headlight	\$85.99
	Oliver Replaces: 1H7379A, 1K7379A Fits: OC-6, Super 55, Super 66, Super 77, Super 88, Super 99, 60, 66, 77, 88	

PARTS FOR LIGHT ABOVE		
B9017-031	Sealed Beam, 12 Volt High Beam	\$18.99
B9017-032	Sealed Beam, 12 Volt Low Beam	\$16.50
	4 1/2" diameter Double Contact Light Bulb 4.365" Outside Diameter	
	B9017-009	\$5.99
Concave Light Mounting Washer/Retainer		

PARTS FOR LIGHT ABOVE		
B9017-071	5 3/4" Lens with Guide Name	\$34.99
B9017-072	5 3/4" Clamp Ring	\$27.99
B9017-073	5 3/4" Gasket	\$4.99
B9017-075	5 3/4" Reflector	\$29.99
B9017-013	6 Volt Bulb	\$3.00
	Pack of 10	\$25.50
B9017-015	12 Volt Bulb	\$3.00
	Pack of 10	\$25.50

Bullet Tail Light, Black		
B9016-074	12 Volt	\$44.99
	Restoration Quality 12 Volt Black Rear Lamp with 2 1/8" O.D. Red Glass Lens, Includes 12 Volt lamp Oliver Replaces: #10A7579, 10A7580 Fits: 66, Super 66, 77, Super 77, 88, Super 88, 660, 880, 950, 990, 995	

B9016-054	Round Fender & Cab Mount Warning Light	\$19.99
	Restoration Quality 12 Volt Round Light with 2 x 4" Diameter Amber Lenses, Double Contact Bulb, 1/2" Diameter Stud, & 2.4" Thick at Widest Point. Oliver Fits: 1265, 1355, 1365, 1465, 1550, 1555, 1600, 1650, 1655, 1750, 1755, 1800, 1850, 1855, 1900, 1950, 1950T, 1955, 2050, 2150, 2250, 2255 (Servicable)	

PARTS FOR LIGHT ABOVE		
B9017-095	Tail Light Gasket	\$2.99
B9017-009	Concave Light Mounting Washer/Retainer	\$5.99

B9016-062	12V Headlight Assembly	\$49.99
	12 Volt 5 3/4" Headlight. Stamped: TRACT-O-LITE on housing. Oliver Fits all to Sn: 81581: 950, 990, 995 Replaces: # 720973AS	

PARTS FOR LIGHT ABOVE		
B9017-033	Sealed Beam, 12 Volt Bulb	\$14.75
	Double Contact High Beam 35 Watts with a 5.625" Outside Diameter Replaces bulb #4419	

DASH LAMPS



B9016-044	Chrome Finish Dash Lamp	\$46.50
	12 Volt, Chrome Finished Dash Lamp. Bulb not Included. Purchase Bulb #B9017-049 if needed. Replaces: Oliver - #K7357A, K7357 Fits: Oliver - Super 66, Super 77, Super 88, 60, 66, 77, 88	

Light Bulbs

B9017-046	6 Volt Bulb	\$1.25
B9017-049	12 Volt Bulb	\$1.25
	Light bulbs for product #B9016-044	

B9017-036	6-Volt Sealed Beam Bulb	\$14.50
	30-Watt, Double Contact, 4.5" Diameter, Low Beam Oliver Replaces: GE #4511 Fits: 60, 66, 70, 77, 80, 88, 90, 99, 440, 500, 550, 660, 770, 880, 900, 950, 990, 995, 1250, 1250A, 1255, 1265, 1355, 1365, 1450, 1465, 1550, 1555, 1600, 1650, 1655, 1750, 1755, 1800, 1850, 1855, 1865, 1870, 1900, 1950, 1950T, 1955, 2050, 2055, 2150, 2155, 2255, 2270, 2655, 2-80, 2-85, 2-105, 2-150, 4-80, 4-85, 4-105, 4-150, 4-180, Super 44, Super 55, Super 66, Super 77, Super 88, Super 99	

AUXILIARY PLUG & SOCKET



B9032-001	2 Pole Auxiliary Plug	\$23.75
	Fits: Oliver - Various Models	
B9032-002	2 Pole Auxiliary Connector	\$19.75
	(Used With B9032-001) Fits: Oliver - Various Models	

STARTER SWITCHES

(MECHANICAL)

B5006-001	Starter Switch (Long Shaft)	\$12.75
	6 or 12 Volt Panel Mounted Manual Push Start Switch Replaces: Delco - #192119, D900, 450C Prestolite - #15-121, 15-122, 15-409, 15-45, 15-47, 15-50, 15-51, SW-2916, SW-4001, SW-4002, SW-4005, SW-4010, SW-4013, SW-4015, SW-4017, SW-4101, SWX-47 Fits: Oliver - Super 99 (with Starter #1108951, & 1113014)	
B5006-004	Starter Switch	\$11.75
	6 or 12 Volt Starter Mounted Manual Push Button Starter Switch Fits: Oliver - Super 88 Gas With Starter #1113007	



SOLENOIDS

B5007-002	12 Volt Solenoid	\$17.50
	12 Volt, 3 Terminal Solenoid with a Curved Mounting Bracket Fits: Oliver - (88, 500, 550, 770, 880 with Starter #1107682), 950 Gas, 1600 Gas, (1850, 1855 with Starter #1107682)	
B5007-010	12 Volt Solenoid (Manual Push Button)	\$20.00
	12 Volt, 3 Terminal Solenoid with a Curved Mounting Bracket & Manual Push Button. Replaces: Autolite - SAE-4005, 15-60, SAW-4201 Fits: Oliver - (88, 500, 550, 770, 880, 950 With Starter #1107682), 1600 Gas, (1850, 1855 With Starter #1107682)	

CARBURETOR REBUILD KITS

B9022-003	Marvel-Schebler Carburetor Rebuild Kit	\$24.99
	Oliver Tractors Model 99, 99HC, 99HL, 99KD, 900, 1600, 1650, 1655, 1800, DG, OC12 Fits Carburetor: Marvel-Schebler Carburetor: #TSX-168, TSX-394, TSX-396, TSX-399, TSX-411, TSX-477, TSX-581, TSX-807, TSXU-837, TSXU-838, TSXU-839, TSX-868, TSX-880 Oliver Carburetor: #22972, 52080-A, 52080-G, 70337, 104726-AS, 7AS-393-A, AS-393-F, AS-393-G, AS-393-H	

B9022-023	Marvel-Schebler Carburetor Rebuild Kit	\$24.50
 <p>Oliver Tractor Model 33, 44, 440, 55HC, [550, 660, Super 77 (Early)], 60, 60HC, 60KD, 66, 66HC, 66KD, 70, 70HC, 77HC, 77KD, 99 HG (Hercules IXB-3), OC-3, OC-6, OC-6HC, Super 44, Super 55, Super 66 Fits Carburetor:</p>		
<p>Marvel-Schebler Carburetor:</p>		
<p>#1004SL, TSX101, TSX102, TSX103, TSX112, TSX113, TSX114, TSX119, TSX120, TSX126, TSX128, TSX13, TSX132, TSX132A, TSX133, TSX134, TSX136, TSX137, TSX138, TSX140, TSX141, TSX142, TSX144, TSX146, TSX147, TSX148, TSX150, TSX151, TSX154, TSX155, TSX156, TSX157, TSX159, TSX161, TSX167, TSX171, TSX173, TSX179, TSX180, TSX182, TSX183, TSX184, TSX186, TSX188, TSX189, TSX190, TSX191, TSX192, TSX193, TSX194, TSX197, TSX198, TSX202, TSX203, TSX206, TSX206-1, TSX211, TSX212, TSX225, TSX228, TSX231, TSX237, TSX239, TSX239-1, TSX240, TSX241A, TSX241B, TSX241C, TSX246, TSX248, TSX253, TSX254, TSX258, TSX260, TSX264, TSX266, TSX267, TSX269, TSX272, TSX274, TSX278, TSX28, TSX280, TSX286, TSX287, TSX288, TSX289, TSX29, TSX290, TSX297, TSX30, TSX301, TSX305, TSX306, TSX308, TSX309, TSX312, TSX314, TSX315, TSX319, TSX322, TSX323, TSX326, TSX328, TSX33, TSX330, TSX331, TSX332, TSX333, TSX334, TSX335, TSX338, TSX339, TSX34, TSX341, TSX346, TSX347, TSX348, TSX35, TSX351, TSX352, TSX356, TSX357, TSX358, TSX359, TSX36, TSX361, TSX361-A, TSX363, TSX366, TSX367, TSX368, TSX37, TSX370, TSX370-1, TSX377, TSX38, TSX380, TSX388, TSX389, TSX39, TSX391, TSX398, TSX400, TSX403, TSX405, TSX406, TSX407, TSX409, TSX418, TSX419, TSX42, TSX420, TSX421, TSX422, TSX423, TSX428, TSX43, TSX44, TSX443, TSX447, TSX448, TSX45, TSX450, TSX452, TSX453, TSX455, TSX458, TSX459, TSX465, TSX470, TSX472, TSX474, TSX48, TSX480, TSX481, TSX484, TSX486, TSX49, TSX497, TSX500, TSX507, TSX510, TSX513, TSX514, TSX516, TSX518, TSX520, TSX525, TSX531, TSX532, TSX534, TSX539, TSX54, TSX541, TSX55, TSX551, TSX552, TSX556, TSX558, TSX560, TSX567, TSX569, TSX570, TSX573, TSX577, TSX58, TSX580, TSX589, TSX59, TSX593, TSX595, TSX597, TSX60, TSX603, TSX605, TSX606, TSX611, TSX614, TSX618, TSX626, TSX633, TSX635, TSX643, TSX646, TSX649, TSX649-1, TSX650, TSX653, TSX655, TSX656, TSX660, TSX663, TSX665, TSX668, TSX670, TSX671, TSX676, TSX680, TSX681, TSX683, TSX69, TSX690, TSX691, TSX692, TSX694, TSX696, TSX701, TSX706, TSX709, TSX710, TSX714, TSX730, TSX736, TSX74, TSX742, TSX744, TSX748, TSX753, TSX76, TSX762, TSX765, TSX767, TSX770, TSX771, TSX776, TSX776-1, TSX78, TSX781, TSX787, TSX79, TSX793, TSX796, TSX80, TSX802, TSX803, TSX804, TSX809, TSX812, TSX815, TSX820, TSX826, TSX827, TSX83, TSX830, TSX841, TSX844, TSX85, TSX851, TSX855, TSX857, TSX860, TSX862, TSX864, TSX865, TSX866, TSX879, TSX88, TSX882, TSX89, TSX896, TSX896SL, TSX90, TSX901, TSX91, TSX912, TSX913, TSX914, TSX919, TSX926, TSX930, TSX931, TSX936, TSX936SL, TSX937, TSX937SL, TSX94, TSX948, TSX949, TSX95, TSX954, TSX957, TSX957SL, TSX95A, TSX96, TSX971, TSX976, TSX978, TSX979, TSX979-1, TSX98, TSX983, TSX986, TSX987, TSX99, TSX990, TSX991, TSX991-1, TSX996, TSXU828, TSXU829, TSXU830, TSXU831, TSXU832, TSXU833, TSXU834, 1003</p>		

B9022-005	Marvel-Schebler Carburetor Rebuild Kit	\$23.99
 <p>Oliver Tractors Model 1550, 1555, 550, 560, 66, 660, 77, 770, 88, 880, OC-4 (Industrials: Power Units), Super 77, Super 88 Fits Carburetor:</p>		
<p>Marvel-Schebler Carburetor:</p>		
<p>TSX1001, TSX1002, TSX181, TSX221, TSX245, TSX296, TSX332, TSX360, TSX374, TSX397, TSX413, TSX414, TSX436, TSX464, TSX466, TSX475, TSX492, TSX505, TSX506, TSX506A, TSX526, TSX528, TSX530, TSX561, TSX562, TSX563, TSX575, TSX582, TSX592, TSX596, TSX602, TSX605, TSX606, TSX610, TSX615, TSX633, TSX639, TSX641, TSX645, TSX648, TSX662, TSX678, TSX688, TSX689, TSX695, TSX704, TSX711, TSX713, TSX719, TSX721, TSX725, TSX732, TSX737, TSX738, TSX755, TSX756, TSX757, TSX759, TSX768, TSX769, TSX772, TSX773, TSX775, TSX777, TSX784, TSX788, TSX791, TSX792, TSX797, TSX798, TSX799, TSX800, TSX801, TSX806, TSX808, TSX810, TSX811, TSX813, TSX814, TSX816, TSX819, TSX825, TSX836, TSX843, TSX849, TSX853, TSX854, TSX856, TSX857, TSX867, TSX869, TSX871, TSX877, TSX878, TSX881, TSX883, TSX884, TSX885, TSX886, TSX888, TSX889, TSX892, TSX892S, TSX893, TSX894, TSX895, TSX897, TSX898, TSX899, TSX900, TSX902, TSX903, TSX904, TSX904SL, TSX905, TSX905-1, TSX905SL, TSX906, TSX906SL, TSX907, TSX907SL, TSX908, TSX908SL, TSX911, TSX917, TSX920, TSX920SL, TSX921SL, TSX922, TSX922SL, TSX923, TSX923SL, TSX925, TSX927, TSX928, TSX932, TSX932SL, TSX933, TSX934, TSX934SL, TSX938, TSX938SL, TSX939, TSX940, TSX940SL, TSX941, TSX941SL, TSX942, TSX943, TSX944SL, TSX945SL, TSX946, TSX947SL, TSX949, TSX950, TSX952, TSX952SL, TSX955, TSX959, TSX959SL, TSX961, TSX961SL, TSX962, TSX962SL, TSX964SL, TSX965SL, TSX966, TSX967SL, TSX968SL, TSX97, TSX972, TSX973, TSX974, TSX974SL, TSX975, TSX975SL, TSX977, TSX980, TSX980SL, TSX984SL, TSX985, TSX985SL, TSX988, TSX989, TSX993, TSX994, TSX997, TSX998, TSX999, TSXU1006, TSXU1007, TSXU835, TSXU836, TSXU840, TSXU904, TSXU904SL, TSXU905, TSXU905-1, TSXU944SL, TSXU963, TSXU9631, TSXU995</p>		
B9022-008	Zenith Carburetor Rebuild Kit	\$26.95
 <p>Oliver Tractors Model 70HC Fits Carburetor: Zenith Carburetor: #8627, 9725, 9725A, 10002, 12522, 12544, 12566, 14544 Oliver Carburetor: #BS-393-D, BS-393-G, BS-393-J</p>		

B9022-009	Zenith Carburetor Rebuild Kit	\$27.99
 <p>Oliver Tractors Model 70HC Fits Carburetor: Zenith Carburetor #8543, 8543A, 9739, 9739A, 11664, 12259, 14644 Massey Harris Carburetor: #101605-AS, BS-393-F, BS-393-H</p>		

B9022-011	Zenith Carburetor Rebuild Kit	\$24.99
 <p>Oliver Tractors Model 70KD, 77HC & Super, 88HC & Supers Fits Carburetor: Zenith Carburetor #11580, 12991, 12992, 12994, 14991, 14992 Oliver Carburetor #11580, 12991, 12992, 12994, 14991, 14992</p>		

B9023-015	Zenith Float	\$24.99
 <p>Oliver Tractors Model Super 77, 88, 660 Replaces:Zenith: #C85-115, C85-115S Fits Carburetor: (various- see www.brillman.com)</p>		

CARBURETOR ACCESSORIES

B9038-003	Carburetor Elbow Fuel Line Fitting with Strainer	\$7.99
 <p>1/8" Pipe to 1/4" Flare. Works with Carter UT Series and Various Marvel-Schebler Carburetors. Oliver Fits - 60, 66, 70, 77, Super 77, 88, Super 88, 660, 770, 880, 80, 90, 99, Super 99, Super 44, Super 55, Super 66, 440, 500, 550, 900, 950, 990, 995, 1250, 1250A, 1255, 1265, 1355, 1365, 1450, 1465, 1550, 1555, 1600, 1650, 1655, 1750, 1755, 1800, 1850, 1855, 1865, 1870, 1900, 1950, 1950T, 1955, 2-105, 2-150, 2-80, 2-85, 2050, 2055, 2150, 2155, 2255, 2270, 2655, 4-105, 4-150, 4-180, 4-80, 4-85</p>		

B9038-007	2" Sediment Bowl Gasket	\$2.19
 <p>2" Outer Diameter, Bowl to Body; Fits a 1.28" Tall Glass Bowl Oliver Replaces: 1J-5304 Fits (w/ 1.280" tall glass bowl): 60, 70, 440, 1550, 1555, 1600, 1650, 1655, 1950T, 2050, 2150, OC-3, Super 44, Super 99 (Gas, w/ 1.280" tall glass bowl): 66, 77, 88, 550, 660, 770, 880, 1750, 1755, 1800, 1850, 1855, Super 55, Super 66, Super 77, Super 88</p>		

FUEL SEDIMENT BOWLS

B9036-002	Fuel Sediment Bowl	\$34.99
 <p>3/8" Pipe Inlet, 1/8" Pipe Outlet, and a 2.315" tall glass bowl Oliver Replaces: 112180, CS841, JS841, WJAS841 Fits (Using 2.315 Long Glass Bowl): 60 Gas, 66 Gas / Dsl., 70 Gas, 80, 90, 99, SUPER 99 Gas, SUPER 66, 660 Gas / Dsl., 950 Gas / Dsl. Industrial: OC-3, 18-28, 28-44</p>		

Parts for Sediment Bowl Above

B9038-024	Connector w/ Female Fitting	\$8.99
B9038-008	2" Sediment Bowl Screen	\$3.99
B9038-012	Sediment Bowl Gasket	\$2.99

B9036-001	Fuel Sediment Bowl	\$27.99
 <p>3/8" Pipe Inlet and a 1/8" Pipe Outlet. Bowl is 1.280" Long. Shallow Bowl has 90° Outlet Only. Oliver Replaces: #1JAS841, JAS841 Fits (Using 1.280 Tall Sediment Bowl Glass): HG, OC-3, Super 44, Super 55, 77, 88, 440, 550, 770, 880 (Gas Only), Super 66, Super 77, Super 88, 1800, 660 Gas, 1550, 1555, 1600, 1650, 1655 (Gas / Dsl.), 1750, 1755, 1850, 1855, 1950T, 2050, 2150 (Dsl.); 60 & 66 (Serviceable)</p>		

CARBURETOR FLOATS

B9023-003	Marvel-Schebler Float	\$12.75
 <p>Replaces: Marvel Schebler: #30-600 Oliver: #HS7605 Fits Oliver Tractors Model HG (Hercules IXB-3), OC-3, OC-6HC, 30, 44, 55HC, 60HC, 60KD, 66HC, 66KD, 70HC, 77HC, 77KD, 99, 550 Marvel-Schebler Carburetor: #TSX-49, TSX-69, TSX-120, TSX-138, TSC-186, TSX-264, TSX-363, TSX-380, TSX-403, TSX-405, TSX-406, TSX-418, TSX-472, TSX-480, TSX-520, TSX-531, TSX-603, TSX-665, TSX-694, TSXU-828, TSXU-831, TSXU-832, TSXU-833 Oliver Carburetor: #117834, 450462-G, 700133-GS, 1514321, AC-7459, BS-393-K, C-116911, C-117144, HS-393-A, HS-393-B, ILS-393-B, LS-393-A, MS-393, MS-393-A</p>		

B9023-004	Marvel-Schebler Float	\$19.95
 <p>Replaces: Marvel Schebler: #30-631, 30-739 Fits Oliver Tractors Model OC-4, 66, 77HC, Super 77, 88, Super 88, 550, 560, 660, 770, 1550, 1555 Marvel-Schebler Carburetor: #TSX-181, TSX-221, TSX-374, TSX-610, TSX-738, TSX-755, TSX-775, TSX-791, TSX-811, TSX-903, TSXU-835, TSXU-836, TSXU-963 Oliver Carburetor: #51083-B, 101604-AS, 102631-AS, 105730, 604808-FS, 604808-FY, IKS-393-B, IKS-393-C, KS-393-C</p>		

B9023-012	Marvel-Schebler Float	\$29.50
 <p>Replaces: Marvel Schebler: #30-621 Oliver: #AS-7605 Fits Oliver Tractors Model 99, 99HC, 99HL, 99KD, 900, 1600, 1650, 1655, 1800, DG, OC12 Marvel-Schebler Carburetor: #TSX-168, TSX-394, TSX-396, TSX-399, TSX-411, TSX-477, TSX-581, TSX-807, TSXU-837, TSXU-838, TSXU-839, TSX-868, TSX-880 Oliver Carburetor: #22972, 52080-A, 52080-G, 70337, 104726-AS, 7AS-393-A, AS-393-F, AS-393-G, AS-393-H</p>		

ROCK ISLAND/ HEIDER

SPARK PLUG WIRE SETS

Rock Island/ Heider Model C 15-27

Waukesha P Engine
4 Cyl. Tailored Spark Plug Wire Set

B1116-001	Original Type Cotton Braid Wire	\$50.00
------------------	--	----------------

Rock Island/ Heider Model G 15-25

Waukesha N Engine
4 Cyl. Tailored Spark Plug Wire Set

B1116-002	Original Type Cotton Braid Wire	\$50.00
------------------	--	----------------

RUMELY OIL PULL

SPARK PLUG WIRE SETS

Rumely Oil Pull 14-28, 16-30H, 20-35M

2 Cyl. Tailored Spark Plug Wire Set

B1039-001	Original Type Cotton Braid Wire	\$26.25
------------------	--	----------------

Rumely Oil Pull 15-25L

2 Cyl. Tailored Spark Plug Wire Set

B1039-009	Original Type Cotton Braid Wire	\$26.25
------------------	--	----------------

Rumely Oil Pull 20-30W

2 Cyl. Tailored Spark Plug Wire Set

B1039-003	Original Type Cotton Braid Wire	\$26.25
------------------	--	----------------

Rumely Oil Pull 20-40G

2 Cyl. Tailored Spark Plug Wire Set

B1039-010	Original Type Cotton Braid Wire	\$26.25
------------------	--	----------------

Rumely Oil Pull 20-40X, 25-40X

2 Cyl. Tailored Spark Plug Wire Set

B1039-005	Original Type Cotton Braid Wire	\$26.25
------------------	--	----------------

Rumely Oil Pull 25-45R

2 Cyl. Tailored Spark Plug Wire Set

B1039-011	Original Type Cotton Braid Wire	\$36.25
------------------	--	----------------

Rumely Oil Pull 20-50X

2 Cyl. Tailored Spark Plug Wire Set

B1039-007	Original Type Cotton Braid Wire	\$26.25
------------------	--	----------------

Rumely Oil Pull 30-50Y

2 Cyl. Tailored Spark Plug Wire Set

B1039-008	Original Type Cotton Braid Wire	\$36.25
------------------	--	----------------

Rumely Do-All

4 Cyl. Tailored Spark Plug Wire Set

B1039-006	Original Type Cotton Braid Wire	\$26.25
------------------	--	----------------

SHAW DO-ALL

SPARK PLUG WIRE SETS

2 Cyl. Shaw Do-All

2 Cyl. Tailored Spark Plug Wire Set

B1040-001	Original Type Cotton Braid Wire	\$22.75
------------------	--	----------------

SILVER KING

SPARK PLUG WIRE SETS

Our Spark Plug Wire Sets Come
**Fully Assembled with the Proper
Type Wire & Terminals.**

They are Custom Tailored to Look &
Fit Like Original Factory Equipment.

Varieties include:

Cotton Braid Wire: Copper Core
with a Cotton Jacket.

PVC Wire: Copper Core with a Rubber Jacket.

EPDM Wire (E): Hi Performance Premium Conductor with
a Tinned Copper Core, EPDM Silicone Insulation, and a
Rubber Jacket.

Suppression Wire (S): for Electronic Ignition and is Spiral
Wound, Ultra Low-Ohm, with EPDM Silicone Insulation
and a Rubber Jacket.



Silver King

with Hercules IXA Engine & WICO Series C Magneto

4 Cyl. Tailored Spark Plug Wire Set

B1041-001	Original Type Cotton Braid Wire	\$33.50
B1041-001E	EPDM Wire	\$36.50

Silver King R38

with Hercules IXB Engine

4 Cyl. Tailored Spark Plug Wire Set

with Magneto

B1041-002	Original Type Cotton Braid Wire	\$23.75
B1041-002E	EPDM Wire	\$26.00

with Distributor

B1041-005	Original Type Cotton Braid Wire	\$20.25
B1041-005E	EPDM Wire	\$22.00

Silver King R42

with Continental F162 Engine

4 Cyl. Tailored Spark Plug Wire Set

B1041-003	Original Type Cotton Braid Wire	\$23.75
B1041-003E	EPDM Wire	\$26.00
B1041-003S	Suppression Wire	\$26.00

Silver King R44

with Hercules Engine & Magneto

4 Cyl. Tailored Spark Plug Wire Set

B1041-004	Original Type Cotton Braid Wire	\$23.75
B1041-004E	EPDM Wire	\$26.00

BATTERY CABLES



Our Battery Cables are made from the Proper Gauge Copper, as either Black Cotton Braided Wire or PVC Wire (whichever is correct for the application), using Soldered & Heat Sealed Brass or Copper Terminals.

Silver King Model R38, R44

with Correct Armor Covering

B2041-004	Positive Battery Cable	\$59.25
B2041-005	Negative Battery Cable	\$51.75
B2041-006	Switch to Starter Cable	\$72.50

Silver King Model 41

with Correct Armor Covering

B2041-001	Switch to Starter Cable	\$61.00
------------------	-------------------------	----------------

Silver King Model 440

with Correct Armor Covering

B2041-002	Positive Battery Cable	\$57.50
B2000-005	Negative Ground Strap	\$12.50
B2041-003	Switch to Starter Cable	\$74.25

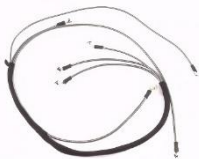

WIRING HARNESSSES

Our Wire Harnesses are made with our premium cotton braid and/or PVC wire.

They have the correct gauge, color, wire, & fuse holders (if needed).

All terminals are soldered according to the original.

(Harnesses do not include Battery Cables & Spark Plug Wires; however, we can supply these as separate products.)

NO HIDDEN COSTS, NOTHING EXTRA TO BUY!!

Silver King Model 42 (with Hood-Mounted Headlights)

B3041-001	Complete Wire Harness	\$290.50
------------------	-----------------------	-----------------

Silver King Model 42 (with Fender-Mounted Headlights)

B3041-002	Complete Wire Harness	\$290.50
------------------	-----------------------	-----------------

TUNE UP PARTS

Silver King Model 149-7 "Mountain State Model (with Delco Distributor # 1111526)

	B4100-001	\$10.50
	PCR Kit Includes: Points (#B4001-001), Condenser (#B4002-001), Rotor (#B4004-002) Replaces: Points - #D100HP, 1855720 Condenser - #1928111, D-203, 1869704, D-200 Rotor - #820445, D400	
	B4004-002	\$5.75
	Rotor Replaces: #820445, D400	
	B4003-001	\$13.50
	Distributor Cap Premium Grade, Made in the USA (Brass Contacts) Replaces: #811735, D300	

	B4006-001	\$9.99
	Dust Cover Replaces: #1900119	
	B4007-001	\$11.95
	Cap Clip Short Mount, 1 Used Replaces: #1889967, 1847289, 453844, 453461	
	B4007-002	\$11.95
	Cap Clip Long Mount, 1 Used Replaces: #1889967, 1889999, 453844, 453461	
	B4008-001	\$14.99
	Distributor Insulator Replaces: #1904376	
	B4009-001	\$25.99
	Distributor Bushing & Shim Kit	

Silver King Model R38 with Hercules #IXB Engine & Autolite Distributor # IGW-4120		
	B4001-002	\$14.75
Points Replaces: #IGW-3028S, 1-31		
	B4002-005	\$9.75
Condenser Replaces: #2-24, 2-35, 2-22, 2-23		
	B4004-004	\$11.50
Rotor Premium Grade, Made in the USA Replaces: #4-15, IGB-1239		
	B4003-004	\$14.50
Distributor Cap Premium Grade, Made in the USA (Brass Contacts) Replaces: #IGB-1241, IGB1241A, 3-21, 3-22		

Silver King with IGB 4057B Autolite Distributor		
	B4001-002	\$14.75
Points Replaces: #IGW-3028S, 1-31		
	B4002-005	\$9.75
Condenser Replaces: #2-24, 2-35, 2-22, 2-23		
	B4003-062	\$21.50
Cap Replaces: #IGB-1001, 3-14		
	B4004-016	\$9.50
Rotor Premium Grade, USA Replaces: #IGB-1002, 4-12		

GAUGES

Ammeters, Universal

B9025-002	Ammeter 20-0-20	\$19.99
	Has a black face with white lettering and a chrome bezel Does not have a logo Dimensions: Fits in 2" Diameter Hole 1.850" From Post to Bottom of Bezel	

B9025-008	Ammeter 60-0-60	\$19.99
	Has a black face with white lettering & a chrome bezel Uses threaded terminals and is dash mounted Used with 12-Volt Alternator Systems Dimensions: Fits in 2" Diameter Hole Measures 1.765" from Top of Post to Bottom of Bezel	

ELECTRONIC IGNITION CONVERSION KITS

Replaces Points & Condenser



Silver King Model 149-7 "Mountain State Model with Delco Distributor # 1111526		
B9600-007	12 Volt Negative Ground	\$154.95
B9600-007P6	6 Volt Positive Ground	\$169.45
B9600-007P12	12 Volt Positive Ground	\$169.45



For Ignition Coils & Accessories, see p.44

LIGHTS & LIGHT PARTS

B9016-003	7" Flat Lens Type Head Lamp	\$99.99
	6 Volt Head, & Clear Rear Lamp (Can be used as 12 Volt by Changing Bulb)	









PARTS FOR LIGHT ABOVE

Headlamp & Parts are interchangeable with original except as noted.

B9017-002	7" Lens With Guide Name	\$21.99
B9017-003	7" Clamp Ring	\$17.99
B9017-005	7" Gasket	\$8.99
B9017-006	7" Reflector *Call for Availability*	\$16.50
B9017-067	7" Light Terminal	\$6.00
B9017-013	6 Volt Bulb Fits Above Reflector, Not Original	\$3.00
	Pack of 10	\$25.50
B9017-015	12 Volt Bulb Fits Above Reflector, Not Original	\$3.00
	Pack of 10	\$25.50

STANDARD TWIN

TUNE UP PARTS

With WICO Magneto #XH32		
	B4011-004 Points Replaces: #1-5008, 1-5111, FXH-2100B, FXH-2400B, X5996	\$17.75
	B4012-002 Condenser Replaces: #2-5007, X5614, X6916	\$13.75
	B4017-040 Condenser Clamp Replaces: #94-5167	\$2.75
	B4013-012 Cap Replaces: #3-5012	\$34.25
	B4014-006 Rotor Replaces: #4-5018, FXH1008, X5531	\$8.25
	B4016-004 Cap Gasket Replaces: #94-5076	\$2.25
	B4015-003 Coil (Hot Coil) Replaces: #5-5011, AR12006, FXH2403, X5700, X5700B, X5700C	\$39.75
	B4017-003 Coil Clamp 2 used, each sold separately Replaces: #94-5080	\$2.25
	B4017-004 Coil Bar Replaces: #94-5066	\$8.50

	B4017-005 Inner Bearing Replaces: #24-5000	\$3.50
	B4017-006 Outer Bearing Replaces: #25-5000	\$9.75
	B4017-046 Bearing Cage Snap Ring Replaces: #43-5055	\$2.75
	B4017-007 Impulse Spring Replaces: #94-5016	\$12.50
	B4017-032 Wico Counter-Clockwise Impulse Trip Arm Assembly Replaces: #94-5115	\$23.75
	B4017-034 CCW Paw Mount *Call for Availability* (Included with B4017-032 above) Replaces: #FXH-1025B, 90-5064	\$14.75
	B4017-008 Stop Button Assembly Includes #B4017-009 Replaces: #90-5042 For the version with a Ground Wire, use #B4017-063 (\$7.26) instead.	\$6.25
	B4017-009 Stop Button Replaces: #94-5079	\$2.25
	B4017-051 WICO Impulse Catch Plate Replaces: #94-5070, FXH-210S-1	\$10.25
	B4016-005 Flange Gasket Replaces: #SAE	\$1.75
	B4016-012 Striker Plate Gasket Replaces: #94-5154	\$2.25
	B9013-011 WICO Series X Nameplate Fits the WICO Series X magneto (Rivets included)	\$7.00

TWIN CITY

SPARK PLUG WIRE SETS

Our Spark Plug Wire Sets Come Fully Assembled with the Proper Type Wire & Terminals.

They are Custom Tailored to Look & Fit Like Original Factory Equipment.

Varieties include:

Cotton Braid Wire: Copper Core with a Cotton Jacket.

EPDM Wire (E): Hi Performance Premium Conductor with a Tinned Copper Core, EPDM Silicone Insulation, and a Rubber Jacket.



Twin City Model 12-20

4 Cyl. Tailored Spark Plug Wire Set

B1043-006	Original Type Cotton Braid Wire	\$33.50
B1043-006E	EPDM Wire	\$36.50

Twin City Model 17-28

4 Cyl. Tailored Spark Plug Wire Set

B1043-001	Original Type Cotton Braid Wire	\$33.50
B1043-001E	EPDM Wire	\$36.50

Twin City Model 20-35

4 Cyl. Tailored Spark Plug Wire Set

B1043-002	Original Type Cotton Braid Wire	\$33.50
B1043-002E	EPDM Wire	\$36.50

Twin City Model 21-32

4 Cyl. Tailored Spark Plug Wire Set

B1043-003	Original Type Cotton Braid Wire	\$29.75
B1043-003E	EPDM Wire	\$32.50

Twin City Model 27-44

4 Cyl. Tailored Spark Plug Wire Set

B1043-004	Original Type Cotton Braid Wire	\$33.50
B1043-004E	EPDM Wire	\$36.50

Twin City Model J

4 Cyl. Tailored Spark Plug Wire Set

B1043-005	Original Type Cotton Braid Wire	\$29.75
B1043-005E	EPDM Wire	\$32.50

Twin City Model KTA

4 Cyl. Tailored Spark Plug Wire Set

B1043-007	Original Type Cotton Braid Wire	\$29.75
B1043-007E	EPDM Wire	\$32.50

WALLIS

SPARK PLUG WIRE SETS

Our Spark Plug Wire Sets Come Fully Assembled with the Proper Type Wire & Terminals.

They are Custom Tailored to Look & Fit Like Original Factory Equipment.

Varieties include:

Cotton Braid Wire: Copper Core with a Cotton Jacket.

EPDM Wire (E): Hi Performance Premium Conductor with a Tinned Copper Core, EPDM Silicone Insulation, and a Rubber Jacket.



Wallis Cub

4 Cyl. Tailored Spark Plug Wire Set

B1044-001	Original Type Cotton Braid Wire	\$33.50
B1044-001E	EPDM Wire	\$36.50

Wallis 15-27, 20-30

4 Cyl. Tailored Spark Plug Wire Set

B1044-002	Original Type Cotton Braid Wire	\$33.50
B1044-002E	EPDM Wire	\$36.50

WATERLOU BRONCO

WIRING HARNESSSES

Waterlou Bronco Serial #101 To 700

B3045-001	Complete Wire Harness	\$118.50
------------------	------------------------------	-----------------

WAUKESHA ENGINES

Waukesha F817G Engine

6 Cyl. Tailored Spark Plug Wire Set

B1115-001	Original Type EPDM Wire	\$39.50
------------------	--------------------------------	----------------

B9500-006	4-Cylinder Pertronix Distributor	\$309.45
------------------	---	-----------------





12-Volt, Negative Ground
Waukesha
Replaces: 60262K, 69748A
Delco: 1111700, 1112685
Prestolite: IBT-4105A, IDU-4403A,
IDU-4403B Fits: 1970-92
(D155G, D176G, VRG220)

Note: Must use Suppression Spark Plug Wire. Use of any other type of Wire will Void the Warranty.

PARTS FOR DISTRIBUTOR ABOVE

	B9503-001 Cap Kit Includes Gasket	\$18.45
	B9504-002 Rotor Kit Includes Gasket	\$8.45
	B9505-001 Dust Cover	\$6.45
	B9508-001 Cap Gasket	\$3.95
	B9509-005 Gear Kit	\$31.45

Waukesha with Fairbanks-Morse Magnets #FM-R6A, FM-XOR6A, FM-XOR6B, FM-XR6A, FM-Z6A, FM-Z6B

	B4014-017 Rotor Replaces: #Z2765	\$36.50
	B4013-036 Cap Replaces: #Q800 Includes Cap Brush	\$87.50

WICO EK

WICO EK Magneto Tune Up Parts

	B4011-013 Points Replaces: #IKBX-505, I2-302, I2-X502D	\$21.75
	B4012-010 Condenser Replaces: #X6494	\$8.50
	B4017-026 Lead Out Tower Replaces: #IKCX-121	\$5.75
	B4015-009 Coil Set 2 Matched Coils Replaces: #IKBX-241	\$129.50
	B4017-027 Rebuild Kit Includes Points, Condenser, 2 Coils, Lead Out Tower & Insulating Material Replaces: #IKBX-505, I2-302, I2-X502D, X6494, IKCX-121, IKBX-241, (2) IKD-206	\$174.50
	B4017-028 Front Cover with Stop Button Replaces: #IKIIX-214	\$24.50
	B4017-029 Rear Cover Replaces: #IKA-153	\$17.50
	B4017-030 Side Band Wrap Replaces: #IKAX-132	\$31.50
	B9013-009 WICO EK Nameplate Fits the WICO EK magneto (Rivets included)	\$9.00

WISCONSIN

TABLE OF CONTENTS

Spark Plug Wire Sets	390
Replacement Distributors	391
Tune Up Parts (Distributor)	392
Electronic Ignition Conversion Kits	395
Replacement Magnetos	396
Tune Up Parts (Magneto Ignition)	396
Identification Tags	403
Starter Switches	403
Carburetor Rebuild Kits	403
Carburetor Floats	403

SPARK PLUG WIRE SETS

Our Spark Plug Wire Sets Come Fully Assembled with the Proper Type Wire & Terminals.

They are Custom Tailored to Look & Fit Like Original Factory Equipment.

Varieties include:

Cotton Braid Wire: Copper Core with a Cotton Jacket.

PVC Wire: Copper Core with a Rubber Jacket.

EPDM Wire: Hi Performance Premium Conductor with a Tinned Copper Core, EPDM Silicone Insulation, and a Rubber Jacket.

Suppression Wire (S): for Electronic Ignition and is Spiral Wound, Ultra Low-Ohm, with EPDM Silicone Insulation and a Rubber Jacket.



Wisconsin AEND

1 Cyl. Tailored Spark Plug Wire

B1047-020	Original Type EPDM Wire	\$9.00
B1047-020S	Suppression Wire	\$9.00

Wisconsin AENL

1 Cyl. Tailored Spark Plug Wire

B1047-011	Original Type EPDM Wire	\$9.00
B1047-011S	Suppression Wire	\$9.00

Wisconsin AHH

1 Cyl. Tailored Spark Plug Wire

B1047-023	Original Type PVC Wire	\$9.00
B1047-023E	EPDM Wire	\$9.00

Wisconsin AKN, BKN

1 Cyl. Tailored Spark Plug Wire

B1047-001	Original Type EPDM Wire	\$9.00
B1047-001S	Suppression Wire	\$9.00

Wisconsin AKS

1 Cyl. Tailored Spark Plug Wire

B1047-002	Original Type PVC Wire	\$9.00
B1047-002E	EPDM Wire	\$9.00

Wisconsin TE

2 Cyl. Tailored Spark Plug Wire Set

B1047-019	Original Type EPDM Wire	\$16.00
-----------	-------------------------	---------

Wisconsin THD

2 Cyl. Tailored Spark Plug Wire Set

with Magneto

B1047-003	Original Type EPDM Wire	\$14.75
-----------	-------------------------	---------

with Distributor

B1047-021	Original Type PVC Wire	\$18.75
B1047-021E	EPDM Wire	\$18.75
B1047-021S	Suppression Wire	\$18.75

Wisconsin TJD

2 Cyl. Tailored Spark Plug Wire Set

with Magneto

B1047-004	Original Type EPDM Wire	\$14.75
-----------	-------------------------	---------

with Distributor

B1047-016	Original Type EPDM Wire	\$18.75
B1047-016S	Suppression Wire	\$18.75

Wisconsin TSD

4 Cyl. Tailored Spark Plug Wire Set

B1047-005	Original Type PVC Wire	\$21.00
B1047-005E	EPDM Wire	\$25.50

Wisconsin V4E

4 Cyl. Tailored Spark Plug Wire Set

B1047-017	Original Type EPDM Wire	\$32.50
B1047-017S	Suppression Wire	\$32.50

Wisconsin V4FD

4 Cyl. Tailored Spark Plug Wire Set

with Magneto

B1047-007	Original Type EPDM Wire	\$32.50
-----------	-------------------------	---------

with Distributor

B1047-015	Original Type EPDM Wire	\$38.00
B1047-015S	Suppression Wire	\$38.00

Wisconsin V460D, V461D, & V465D

with Side Mount Distributor

4 Cyl. Tailored Spark Plug Wire Set

B1047-014	Original Type EPDM Wire	\$34.00
B1047-014S	Suppression Wire	\$34.00

Wisconsin VE4

4 Cyl. Tailored Spark Plug Wire Set

with Magneto

B1047-008	Original Type PVC Wire	\$29.75
-----------	------------------------	---------

with Prestolite Distributor #IGW-4159A, IGW-4151A, IGW-4187A

B1047-017	Original Type EPDM Wire	\$32.50
B1047-017S	Suppression Wire	\$32.50

Wisconsin VG4D, VH4D

4 Cyl. Tailored Spark Plug Wire Set
with Top Mount Distributor

B1047-009	Original Type EPDM Wire	\$34.00
B1047-009S	Suppression Wire	\$34.00

with Side Mount Distributor

B1047-012	Original Type EPDM Wire	\$34.00
B1047-012S	Suppression Wire	\$34.00

with Side Mount Magneto

B1047-013	Original Type EPDM Wire	\$34.00
------------------	-------------------------	----------------

Wisconsin VP4D

4 Cyl. Tailored Spark Plug Wire Set

B1047-010	Original Type PVC Wire	\$27.00
B1047-010E	EPDM Wire	\$32.50
B1047-010S	Suppression Wire	\$32.50

REPLACEMENT DISTRIBUTORS

B9500-001	2-Cylinder Pertronix Distributor	\$269.95
 <p>12-Volt, Negative Ground Wisconsin Replaces: YF-54, YF-54A <i>Note:</i> Must use Suppression Spark Plug Wire. Use of any other type of Wire will Void the Warranty.</p>		

PARTS FOR DISTRIBUTOR ABOVE

	B9504-001 Rotor Kit Includes Gasket	\$8.45
	B9505-001 Dust Cover	\$6.45
	B9508-001 Cap Gasket	\$3.95
	B9506-003 Module	\$97.95
	B9509-004 Gear Kit	\$31.45

B9500-002	2-Cylinder Pertronix Distributor	\$279.95
 <p>12-Volt, Negative Ground Odd Fire Wisconsin Replaces: YF-42, YF-48, YF-51, YF-51A Prestolite: IBT-4201 Fits: 1980-present (Model W2-1230, W2-1235), 1987-present (Model W2-1250) <i>Note:</i> Must use Suppression Spark Plug Wire. Use of any other type of Wire will Void the Warranty.</p>		

PARTS FOR DISTRIBUTOR ABOVE

	B9504-001 Rotor Kit Includes Gasket	\$8.45
	B9505-001 Dust Cover	\$6.45
	B9508-001 Cap Gasket	\$3.95
	B9509-003 Gear Kit	\$31.45

B9500-008	4-Cylinder Pertronix Distributor (Side Mount)	\$298.95
 <p>12-Volt, Negative Ground Wisconsin Replaces: YF-10C, YF-45, YF-50, YF-50C Prestolite: IAD-6004-2F, IAD-6004-2N, YF-10C Fits (side mount): 1956-present (Model VH4D), 1967-present (Model V65D), 1976-present (Model W4-1770) <i>Note:</i> Must use Suppression Spark Plug Wire. Use of any other type of Wire will Void the Warranty.</p>		

PARTS FOR DISTRIBUTOR ABOVE

	B9503-001 Cap Kit Includes Gasket	\$18.45
	B9504-001 Rotor Kit Includes Gasket	\$8.45
	B9505-001 Dust Cover	\$6.45



	B9506-002 (Negative Ground)	\$97.95
	B9506-004 (Positive Ground)	\$119.50
	Module, 12-volt, 4-cylinder Includes Additional Mounting Parts	
	B9509-003	\$31.45
	Gear Kit	
	B9508-001	\$3.95
	Cap Gasket	

B9500-011	4-Cylinder Pertronix Distributor (Top Mount)	\$279.95
	<p>12-Volt, Negative Ground Wisconsin Replaces: YF-10D, YF-45A, YF-50A, YF-50D Prestolite: IAD-6004-2P Fits (top mount): 1956-present (Model VH4D), 1975-present (Model W4-1770) Note: Must use Suppression Spark Plug Wire. Use of any other type of Wire will Void the Warranty.</p>	

PARTS FOR DISTRIBUTOR ABOVE

	B9503-001	\$18.45
	Cap Kit Includes Gasket	
	B9504-001	\$8.45
	Rotor Kit Includes Gasket	
	B9505-001	\$6.45
	Dust Cover	
	B9506-002 (Negative Ground)	\$97.95
	B9506-004 (Positive Ground)	\$119.50
	Module, 12-volt, 4-cylinder Includes Additional Mounting Parts	
	B9508-001	\$3.95
	Cap Gasket	
	B9509-003	\$31.45
	Gear Kit	



TUNE UP PARTS, DISTRIBUTOR



Wisconsin 1 Cylinder 1950-1973 with Distributors #YF8CS1, YF8S1, IGW-4405, IGW-4408, IGW-4179		
	B4001-002	\$14.75
	Points Replaces: #IGW-3028S, 1-31	
	B4002-005	\$9.75
	Condenser Replaces: #2-24, 2-35, 2-22, 2-23	

*For 6- or 12- Volt Coils & Accessories, see p.44

Wisconsin 2 Cylinder 1950-1974 SK-697P, TC, TE, TF, TFD, TH, THD, THDM, TJD, TSD, with Distributors #IGW-4168A, IGW-4199A, B, C		
	B4001-002	\$14.75
	Points Replaces: #IGW-3028S, 1-31	
	B4002-005	\$9.75
	Condenser Replaces: #2-24, 2-35, 2-22, 2-23	
	B4004-016	\$9.50
	Rotor Premium Grade, USA Replaces: #IGB-1002, 4-12	
	B4003-023	\$18.25
	Distributor Cap Made in the USA (Brass Contacts) Replaces: #IGB-1065C, 3-15, 3-49 #IGW-4199B, YF6-F	



*For 6- or 12- Volt Coils & Accessories, see p.44

Wisconsin 2 Cylinder 1968-1983 TJD with Distributor #IGW-4412		
	B4001-002	\$14.75
	Points Replaces: #IGW-3028S, 1-31	
	B4002-005	\$9.75
	Condenser Replaces: #2-24, 2-35, 2-22, 2-23	



	B4004-016	\$9.50
	Rotor Premium Grade, USA Replaces: #IGB-1002, 4-12	
	B4003-024	\$18.75
	Distributor Cap Premium Grade, Made in the USA (Brass Contacts) Replaces: #IGB-1001B, 3-125	

*For 6- or 12- Volt Coils & Accessories, see p.44

Wisconsin 2 Cylinder 1968-1983 TJD with Distributor #IAD-4046		
B4100-004		\$14.75
	PCR Kit Includes: Points (#B4001-005), Condenser (#B4002-002), Rotor (#B4004-003) Replaces: Points - #1-4, 1-8, 1-9, 1-20, 1-22, 1-45, IAD-3128S, IGP-3028ES, IGP3028FS, IGS2224L, IGW3028AS Condenser - #2-23, 2-31, 2-32, 2-34, 2-38, 2-42, IAT-2015L, IAT-2015R, IAT-3076AS, IAT-3076BS, IAT-3076D, IAT- 3076DS, IAT-3076L, IAT-3076LA, IAT-3076R, IAT-3076RA, IBB-2015L, IBB-2015R, IBB-2042-SS, IBB-2042SS-1, IBB- 2042-SS3, IG-2671F, IGH-3076, IGW-3139, 2098058, 3420600 Rotor - #4-10	

	B4004-003	\$5.25
	Rotor Premium Grade, Made in USA Replaces: #4-10	
	B4003-003	\$21.00
	Distributor Cap (Note: Will Replace the Original 2-Cylinder Cap By Only Using 2 of the Cap Towers) Made in the USA (Brass Contacts) Replaces: #IG-1324D, 3-11, 3-12	



*For 6- or 12- Volt Coils & Accessories, see p.44

Wisconsin 2 Cylinder 1962-1983 with Distributor #IGW-4407, 4408		
	B4001-002	\$14.75
	Points Replaces: #IGW-3028S, 1-31	
	B4002-005	\$9.75
	Condenser Replaces: #2-24, 2-35, 2-22, 2-23	



*For 6- or 12- Volt Coils & Accessories, see p.44



Wisconsin 4 Cylinder VE4, VE4D, VF4, VF4D, VP4, VP4D, VPO4 with Distributor #IGW-4159A		
	B4001-002	\$14.75
	Points Replaces: #IGW-3028S, 1-31	
	B4002-005	\$9.75
	Condenser Replaces: #2-24, 2-35, 2-22, 2-23	
	B4003-025	\$24.75
	Cap Replaces: #IGB-1225D	
	B4004-004	\$11.50
	Rotor Premium Grade, Made in the USA Replaces: #4-15, IGB-1239	
	B4003-026	\$11.00
	Cap Cover Replaces: #IGB-224, 3-32	

*For 6- or 12- Volt Coils & Accessories, see p.44

Wisconsin 4 Cylinder 1950-1974 VE4, VF4, VF4D, VP4, VP4D with Distributor #IGW-4151A, IGW-4187A		
	B4001-002	\$14.75
	Points Replaces: #IGW-3028S, 1-31	
	B4002-005	\$9.75
	Condenser Replaces: #2-24, 2-35, 2-22, 2-23	
	B4004-004	\$11.50
	Rotor Premium Grade, Made in the USA Replaces: #4-15, IGB-1239	

*For 6- or 12- Volt Coils & Accessories, see p.44

Wisconsin 4 Cylinder 1968-1982 V461D, V465D, VG4D, VH4, VH4D, VH4DM with Distributors #AD-6004-2N, IAD-6004-2N, IAD- 6004-2P, YF-10C, B9500-008		
	B4001-005	\$9.75
	Points Replaces: #1-4, 1-8, 1-9, 1-20, 1-22, 1- 45, IAD-3128S, IGP-3028ES, IGP3028FS, IGS2224L, IGW3028AS	
	B4002-006	\$7.50
	Condenser Replaces: #2-31, 2-38, 2- 42, 2-95, IAT-1125S, IAT-3076BS, IBB- 2042SS-1, IBB-2042-SS3, IG-3927F, IG- 3927G, IG-3927K, IG-3927R,	

	B4004-003	\$5.25
	Rotor Premium Grade, Made in USA Replaces: #4-10	
	B4003-003	\$21.00
	Distributor Cap Made in the USA (Brass Contacts) Replaces: #IG-1324D, 3-11, 3-12	

*For 6- or 12- Volt Coils & Accessories, see p.44

Wisconsin 4 Cylinder VG4D with Autolite/ Prestolite Distributor #IAD-6001		
	B4001-005	\$9.75
	Points Replaces: #1-4, 1-8, 1-9, 1-20, 1-22, 1-45, IAD-3128S, IGP-3028ES, IGP3028FS, IGS2224L, IGW3028AS	
	B4002-006	\$7.50
	Condenser Replaces: #2-31, 2-38, 2-42, 2-95, IAT-1125S, IAT-3076BS, IBB-2042SS-1, IBB-2042-SS3, IG-3927F, IG-3927G, IG-3927K, IG-3927R,	
	B4004-007	\$8.25
	Rotor Premium Grade, Made in the USA Replaces: #4-19	
	B4003-007	\$25.00
	Distributor Cap Premium Grade, Made in the USA (Brass Contacts) Replaces: #IGC-1107S, 3-23	

*For 6- or 12- Volt Coils & Accessories, see p.44

Wisconsin 4 Cylinder 1953-1967 V460D, VG4D, VH4, VH4D, VH4DM, VR4, VR4D with Distributor #AD-6004-2R, IAD-6004-2F		
B4100-004		\$14.75
	PCR Kit Includes: Points (#B4001-005), Condenser (#B4002-002), Rotor (#B4004-003) Replaces: Points - #1-4, 1-8, 1-9, 1-20, 1-22, 1-45, IAD-3128S, IGP-3028ES, IGP3028FS, IGS2224L, IGW3028AS Condenser - #2-23, 2-31, 2-32, 2-34, 2-38, 2-42, IAT-2015L, IAT-2015R, IAT-3076AS, IAT-3076BS, IAT-3076D, IAT-3076DS, IAT-3076L, IAT-3076LA, IAT-3076R, IAT-3076RA, IBB-2015L, IBB-2015R, IBB-2042-SS, IBB-2042SS-1, IBB-2042-SS3, IG-2671F, IGH-3076, IGW-3139, 2098058, 3420600 Rotor - #4-10	
		B4004-003
Rotor Premium Grade, Made in USA Replaces: #4-10		
	B4003-003	\$21.00
	Distributor Cap Made in the USA (Brass Contacts) Replaces: #IG-1324D, 3-11, 3-12	

*For 6- or 12- Volt Coils & Accessories, see p.44

Wisconsin 4 Cylinder 1951-1979 VE4, VE4D, VF4, VF4D, VGBD, VP4, VP4D with Distributor #IAD-4036 ^a , YF10S1		
B4100-004		\$14.75
	PCR Kit Includes: Points (#B4001-005), Condenser (#B4002-002), Rotor (#B4004-003) Replaces: Points - #1-4, 1-8, 1-9, 1-20, 1-22, 1-45, IAD-3128S, IGP-3028ES, IGP3028FS, IGS2224L, IGW3028AS Condenser - #2-23, 2-31, 2-32, 2-34, 2-38, 2-42, IAT-2015L, IAT-2015R, IAT-3076AS, IAT-3076BS, IAT-3076D, IAT-3076DS, IAT-3076L, IAT-3076LA, IAT-3076R, IAT-3076RA, IBB-2015L, IBB-2015R, IBB-2042-SS, IBB-2042SS-1, IBB-2042-SS3, IG-2671F, IGH-3076, IGW-3139, 2098058, 3420600 Rotor - #4-10	
		B4004-003
Rotor Premium Grade, Made in USA Replaces: #4-10		
	B4003-003	\$21.00
	Distributor Cap Made in the USA (Brass Contacts) Replaces: #IG-1324D, 3-11, 3-12	

*For 6- or 12- Volt Coils & Accessories, see p.44

Wisconsin 4 Cylinder 1962-1969 VG4D, VH4D, V461D with Distributor #1112596		
	B4100-001	\$10.50
	PCR Kit Includes: Points (#B4001-001), Condenser (#B4002-001), Rotor (#B4004-002) Replaces: Points - #D100HP, 1855720 Condenser - #1928111, D-203, 1869704, D-200 Rotor - #820445, D400	
	B4004-002	\$5.75
	Rotor Replaces: #820445, D400	
	B4003-001	\$13.50
	Distributor Cap Premium Grade, Made in the USA (Brass Contacts) Replaces: #811735, D300	
	B4006-001	\$9.99
	Dust Cover Replaces: #1900119	
	B4007-001	\$11.95
	Cap Clip Short Mount, 1 Used Replaces: #1889967, 1847289, 453844, 453461	
	B4007-002	\$11.95
	Cap Clip Long Mount, 1 Used Replaces: #1889967, 1889999, 453844, 453461	
	B4008-001	\$14.99
	Distributor Insulator Replaces: #1904376	
	B4009-001	\$25.99
	Distributor Bushing & Shim Kit	

*For 6- or 12- Volt Coils & Accessories, see p.44

Did You Know?

Wisconsin's fame came from its small air-cooled engines, such as the AEH.

ELECTRONIC IGNITION **CONVERSION KITS**

Replaces Points & Condenser



Wisconsin 2 Cylinder THD with Prestolite IGW-4199 Distributor		
B9600-310	12 Volt Negative Ground	\$139.95

Wisconsin 4 Cylinder 1951-1979 VE4, VE4D, VF4, VF4D, VP4, VP4D, VPO4 with Distributor #IGW-4159A		
B9600-061	12 Volt Negative Ground	\$129.95
B9600-061N6	6 Volt Negative Ground	\$147.45
B9600-061P6	6 Volt Positive Ground	\$147.45

Wisconsin 4 Cylinder 1962-1969 VG4D, VH4D, V460D, V461D, V465D with Delco Distributor #1112596 & Clip-On-Cap		
B9600-007	12 Volt Negative Ground	\$154.95
B9600-007P6	6 Volt Positive Ground	\$169.45
B9600-007P12	12 Volt Positive Ground	\$169.45

Wisconsin 4 Cylinder 1951-1979 Model #VE4, VE4D, VF4, VF4D, VP4, VP4D (with Distributor #IAD-4036A, YF10S1) 1953-1967 Model #V460D, VG4D, VH4, VH4D, VH4DM, VR4, VR4D (with Distributor #AD-6004-2R, IAD-6004-2F) 1968-1982 Model #V461D, V465D, VG4D, VH4, VH4D, VH4DM (with Distributor #AD-6004-2N, IAD-6004-2N, , YF-10C, B9500-008, IAD-6004-2P)		
B9600-057	12 Volt Negative Ground	\$129.95
B9600-057P12	12 Volt Positive Ground	\$147.45
B9600-057N6	6 Volt Negative Ground	\$147.45
B9600-057P6	6 Volt Positive Ground	\$147.45



For Ignition Coils & Accessories, see p.44

Rebuilt Magnetos

Our Rebuilt Magnetos are completely torn down, cleaned, & inspected. They will (at the minimum) have the following new parts: Points, Condenser, Coil, Coil Insulators, Lead-out Tower, & Outside Covers, plus any additional parts that are needed to make the unit look & perform like new.

They come with a 1-Year Limited Warranty.

Notes:

1. Unless otherwise specified, cost is exchange price.
2. A core charge (see below) will be charged to your credit card until we receive your good core.
3. A good core is considered a complete magneto with no cracks or weld repairs. Only good cores will be credited.

*Magnetos must be used with copper ignition wire.
Use of any other type will Void the Warranty.*

	FMX2B7ER	Exchange	\$475.00
		Outright	\$725.00
Rebuilt Fairbanks Morse Magneto 2 Cyl., Flange Mount Core charge: \$250 Same part as Y79B Fits: Wisconsin TJD			
	FMX4B7AR	Exchange	\$475.00
		Outright	\$725.00
Rebuilt Fairbanks Morse Magneto 4 Cyl., Flange Mount Core charge: \$250 Same part as FMX4B7B, Y97 Fits: Wisconsin VG4D, VH4, VH4D			
	FMX4B7DR	Exchange	\$475.00
		Outright	\$725.00
Rebuilt Fairbanks Morse Magneto 4 Cyl., Flange Mount Core charge: \$250 Same part as Y128 Fits: Wisconsin V461D			
	XH1343BR	Exchange	\$445.00
		Outright	\$645.00
Rebuilt WICO Magneto 4 Cyl., Flange Mount Core charge: \$200 Fits: Wisconsin VD4, VE4, VF4, VM4			
	XH2207R	Exchange	\$445.00
		Outright	\$645.00
Rebuilt WICO Magneto 4 Cyl., Flange Mount Core charge: \$200 Fits: Wisconsin V465, VH4			

TUNE UP PARTS, Magneto

Wisconsin AA, AB, ABN, AD, &, AE, AEH, AEHS, AEN, AENC, AENS, AES, AF, AFG, AFH, AG, AGH, AGND, AH, AJH, AK, AKN, BKN, HACN, HBKN with Wisconsin Magneto #Y108B, Y111 & Others with WICO Magneto #XH150C (Y-58), XH1295D (Y-68-A), XH1995B (Y-62), XH2477B (Y-111), XH2523B (Y-108B)

	B4011-004	\$17.75
	Points Replaces: #1-5008, 1-5111, FXH-2100B, FXH-2400B, X5996	
	B4012-002	\$13.75
	Condenser Replaces: #2-5007, X5614, X6916	
	B4017-040	\$2.75
	Condenser Clamp Replaces: #94-5167	
	B4013-005	\$39.50
	Cap Replaces: #94-5212, FXH-2312A-2	
	B4016-004	\$2.25
	Cap Gasket Replaces: #94-5076	
	B4015-003	\$39.75
	Coil (Hot Coil) Replaces: #5-5011, AR12006, FXH2403, X5700, X5700B, X5700C	
	B4017-003	\$2.25
	Coil Clamp 2 used, each sold separately Replaces: #94-5080	
	B4017-004	\$8.50
	Coil Bar Replaces: #94-5066	
	B4017-005	\$3.50
	Inner Bearing Replaces: #24-5000	
	B4017-006	\$9.75
	Outer Bearing Replaces: #25-5000	
	B4017-046	\$2.75
	Bearing Cage Snap Ring Replaces: #43-5055	
	B4017-007	\$12.50
	Impulse Spring Replaces: #94-5016	

Wiring Harnesses, Battery Cables, & Spark Plug Wires, Proudly Made in the USA!

	B4017-008	\$6.25
Stop Button Assembly Includes #B4017-009 Replaces: #90-5042 For the version with a Ground Wire, use #B4017-063 (\$7.26) instead.		
	B4017-009	\$2.25
Stop Button Replaces: #94-5079		
	B4017-051	\$10.25
WICO Impulse Catch Plate Replaces: #94-5070, FXH-210S-1		
	B4016-005	\$1.75
Flange Gasket Replaces: #SAE		
	B4016-012	\$2.25
Striker Plate Gasket Replaces: #94-5154		
	B4016-015	\$2.25
Impulse Assembly Gasket Replaces: #94-5075		
	B9013-011	\$7.00
WICO Series X Nameplate Fits the WICO Series X magneto (Rivets included)		

	B4016-005	\$1.75
Flange Gasket Replaces: #SAE		
	B4017-001	\$2.75
Coil Lead Replaces: #FMJL		
	B4017-002	\$11.75
Rear Ball Bearing Replaces: #C5949		
	B4017-041	\$16.00
Coupling Impulse Spring Replaces: #D2565		
	B9013-025	\$7.00
Fairbanks-Morse Nameplate for Wisconsin Motor Corp. Fits FM magnetos (Rivets included)		

Wisconsin ADH, AEH, AEHS, AEH8, AEM, AFH, AGH, AHH with Fairbanks-Morse Magneto #FMX17A, FMX17E

Wisconsin 1 Cylinder ABM, ABN, ACN, AEN, AENL, AENS, AGND, AKM, AKN, BKN, HACN, HAENL, HAEW, HBKN with Wisconsin Magneto #Y76, Y107B, Y109, Y117 & Others with Fairbanks-Morse Magneto #FMXD1B7, FMX1B7E, FMXD1B7S, FMXD1B7S-1, FMXD1B7U, FMXD1B7-U		
	B4011-003	\$18.50
Points Replaces: #A2437A		
	B4012-001	\$11.00
Condenser Replaces: #AXMR2433		
	B4013-015	\$32.50
Cap Replaces: #BZ2430		
	B4015-014	\$69.50
Coil Replaces: #T2477C		
	B4016-002	\$2.75
Cap Gasket (Inner) Replaces: #H2498		

	B4011-003	\$18.50
Points Replaces: #A2437A		
	B4012-001	\$11.00
Condenser Replaces: #AXMR2433		
	B4013-016	\$35.00
Call for Availability Cap (B4013-015 can be a substitute) Replaces: #AX2430		
	B4015-002	\$39.75
Coil Replaces: #R2477C		
	B4016-002	\$2.75
Cap Gasket (Inner) Replaces: #H2498		
	B4016-005	\$1.75
Flange Gasket Replaces: #SAE		
	B4017-001	\$2.75
Coil Lead Replaces: #FMJL		
	B4017-002	\$11.75
Rear Ball Bearing Replaces: #C5949		

	B4017-041	\$16.00
	Coupling Impulse Spring Replaces: #D2565	

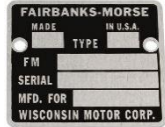
	B9013-025	\$7.00
	Fairbanks-Morse Nameplate for Wisconsin Motor Corp. Fits FM magnetos (Rivets included)	

Wisconsin 2 Cylinder 1968-1983
with Fairbanks-Morse Magneto #FM-X2B6
FM-X2B6D, FM-X2B6E, FM-X2B6F, FMXD1B7R-1

	B4011-011	\$12.75
	Points Replaces: #B2437A	

	B4012-004	\$11.00
	Condenser Replaces: #SXY2433	

	B4013-017	\$64.75
	Cap Replaces: #WZ2430	

	B4014-007	\$16.50
	Rotor Replaces: #FY2765	

	B4015-002	\$39.75
	Coil Replaces: #R2477C	

	B4016-002	\$2.75
	Cap Gasket (Inner) Replaces: #H2498	

	B4016-005	\$1.75
	Flange Gasket Replaces: #SAE	

	B4017-001	\$2.75
	Coil Lead Replaces: #FMJL	

	B4017-002	\$11.75
	Rear Ball Bearing Replaces: #C5949	

	B4017-041	\$16.00
	Coupling Impulse Spring Replaces: #D2565	

Wisconsin 2 Cylinder THD, Y80 With Fairbanks-Morse Magneto #FMX1-2B7, FMX1-2B7-1

	B4011-003	\$18.50
	Points Replaces: #A2437A	

	B4012-004	\$11.00
	Condenser Replaces: #SXY2433	

	B4013-018	\$52.75
	Cap Replaces: #BY2430	

	B4015-010	\$78.50
	Coil Replaces: #Q2477C	

	B4016-002	\$2.75
	Cap Gasket (Inner) Replaces: #H2498	

	B4016-005	\$1.75
	Flange Gasket Replaces: #SAE	

	B4017-002	\$11.75
	Rear Ball Bearing Replaces: #C5949	

	B4017-041	\$16.00
	Coupling Impulse Spring Replaces: #D2565	

Wisconsin 2 Cylinder TJD, W2880, #Y79B
with Fairbanks-Morse Magneto #FM-X2B7E

	B4011-003	\$18.50
	Points Replaces: #A2437A	

	B4012-001	\$11.00
	Condenser Replaces: #AXMR2433	

	B4014-007	\$16.50
	Rotor Replaces: #FY2765	



Wiring Harnesses, Battery Cables, & Spark Plug Wires, Proudly Made in the USA!

	B4013-017	\$64.75
	Cap Replaces: #WZ2430	
	B4015-002	\$39.75
	Coil Replaces: #R2477C	
	B4016-002	\$2.75
	Cap Gasket (Inner) Replaces: #H2498	
	B4016-005	\$1.75
	Flange Gasket Replaces: #SAE	
	B4017-024	\$3.00
	Wipe Cap Brush 3/16" diameter, 3/8" length Replaces: #E2460B	
	B4017-001	\$2.75
	Coil Lead Replaces: #FMJL	
	B4017-002	\$11.75
	Rear Ball Bearing Replaces: #C5949	
	B4017-041	\$16.00
	Coupling Impulse Spring Replaces: #D2565	
	B9013-025	\$7.00
	Fairbanks-Morse Nameplate for Wisconsin Motor Corp. Fits FM magnetos (Rivets included)	

Wisconsin with Fairbanks-Morse Magnetos #FM-XOR6A, FM-XR6A

	B4014-017	\$36.50
	Rotor Replaces: #Z2765	
	B4013-036	\$87.50
	Cap Replaces: #Q800 Includes Cap Brush	

Wisconsin MTFD, TE, TF, TH, THD with WICO Magneto #XH1961B (Y67), XH2531B, XH2531C (Y-67-A)





	B4011-004	\$17.75
	Points Replaces: #1-5008, 1-5111, FXH-2100B, FXH-2400B, X5996	
	B4012-002	\$13.75
	Condenser Replaces: #2-5007, X5614, X6916	

	B4013-019	\$25.50
	Cap Replaces: #94-5092, FXH-2212-2, X7123	
	B4016-004	\$2.25
	Cap Gasket Replaces: #94-5076	
	B4015-011	\$68.50
	Coil Replaces: #5-5030	
	B4017-003	\$2.25
	Coil Clamp 2 used, each sold separately Replaces: #94-5080	
	B4017-008	\$6.25
	Stop Button Assembly Includes #B4017-009 Replaces: #90-5042 For the version with a Ground Wire, use #B4017-063 (\$7.26) instead.	
	B4017-009	\$2.25
	Stop Button Replaces: #94-5079	
	B4017-005	\$3.50
	Inner Bearing Replaces: #24-5000	
	B4017-006	\$9.75
	Outer Bearing Replaces: #25-5000	
	B4017-046	\$2.75
	Bearing Cage Snap Ring Replaces: #43-5055	
	B4017-007	\$12.50
	Impulse Spring Replaces: #94-5016	
	B4016-005	\$1.75
	Flange Gasket Replaces: #SAE	
	B4016-012	\$2.25
	Striker Plate Gasket Replaces: #94-5154	
	B9013-011	\$7.00
	WICO Series X Nameplate Fits the WICO Series X magneto (Rivets included)	

Wiring Harnesses, Battery Cables, & Spark Plug Wires, Proudly Made in the USA!

Wisconsin AC4, AC4S, ACY, AM4, AP4, B2, B3, K2, K2A, SD45, SU, VG4D, VH4, W, X, Y97 with Fairbanks-Morse Magneto #FM-X4B7A, FM-J4B7A		
	B4011-003 Points Replaces: #A2437A	\$18.50
	B4012-001 Condenser Replaces: #AXMR2433	\$11.00
	B4013-035 Cap Replaces: #W800	\$65.25
	B4014-001 Rotor Replaces: #M2765	\$10.50
	B4013-003 Cap (Inner) Replaces: #AZ2430C	\$38.75
	B4015-002 Coil Replaces: #R2477C	\$39.75
	B4016-001 Cap Gasket (Outer) Replaces: #B682	\$2.75
	B4016-002 Cap Gasket (Inner) Replaces: #H2498	\$2.75
	B4016-003 Complete Gasket Set Includes # H2498 (B4016-002), B682 (B4016-001), G2501, G3861, A2492A, Replaces: #GK17	\$14.75
	B4016-005 Flange Gasket Replaces: #SAE	\$1.75
	B4017-001 Coil Lead Replaces: #FMJL	\$2.75
	B4017-050 High Tension Rod Replaces: A983A	\$12.75
	B9013-025 Fairbanks-Morse Nameplate for Wisconsin Motor Corp. Fits FM magnetos (Rivets included)	\$7.00

with Fairbanks Morse Magneto #FMX-E4A7/B7 & FMJ-E4A7		
	B4011-003 Points Replaces: #A2437A For FMX-E4A7/B7	\$18.50
	B4012-004 Condenser Replaces: #SXY2433	\$11.00
	B4014-014 Rotor Replaces: #X2765	\$25.00
	B4015-002 Coil Replaces: #R2477C	\$39.75
	B4017-039 Distributor Shaft Bearing Replaces: #D5950C	\$6.75
	B4017-001 Coil Lead Replaces: #FMJL	\$2.75
	B4017-050 High Tension Rod Replaces: A983A	\$12.75
	B4017-002 Rear Ball Bearing Replaces: #C5949	\$11.75
	B4014-009 Rotor Gear Replaces: #Y5939	\$29.75
B4017-058	FMJ Distributor Shaft Clip	\$2.25
B4017-059	FMJ Distributor Shaft Washer	\$2.25
B4017-060	FMJ Distributor Shaft Felt Seal	\$1.75

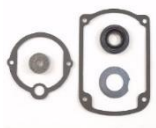

Wisconsin VF4D, Y106 with Fairbanks-Morse Magneto #FMZV4B7		
	B4011-003 Points Replaces: #A2437A	\$18.50
	B4012-001 Condenser Replaces: #AXMR2433	\$11.00
	B4013-020 Cap Replaces: #G800	\$67.50
	B4014-001 Rotor Replaces: #M2765	\$10.50

	B4016-001	\$2.75
	Cap Gasket (Outer) Replaces: #B682	
	B4016-002	\$2.75
	Cap Gasket (Inner) Replaces: #H2498	
	B4016-003	\$14.75
	Complete Gasket Set Includes # H2498 (B4016-002), B682 (B4016-001), G2501, G3861, A2492A, Replaces: #GK17	
	B4016-005	\$1.75
	Flange Gasket Replaces: #SAE	
	B4015-016	\$59.75
	Coil (Std. Quality) Replaces: #QS2477C, S2477C	
	B4015-018	\$236.75
	Coil (Premium Quality) Replaces: # QS2477C, S2477C	
	B4017-002	\$11.75
	Rear Ball Bearing Replaces: #C5949	

Wisconsin AC4, ACY, AC4S, AM4 AP4 B2, B3, K2, K2A, SD45, SU, VG4D, VH4, W, X with Wisconsin Magneto #Y95, Y95A, WICO Magneto #XH184, XH241, XH2207 (Y-95)

	B4011-004	\$17.75
	Points Replaces: #1-5008, 1-5111, FXH-2100B, FXH-2400B, X5996	
	B4012-002	\$13.75
	Condenser Replaces: #2-5007, X5614, X6916	
	B4017-040	\$2.75
	Condenser Clamp Replaces: #94-5167	
	B4014-002	\$23.50
	Rotor Replaces: #4-5010	



	B4013-004	\$36.75
	Cap Includes #B4016-004 Replaces: #3-5014	
	B4016-004	\$2.25
	Cap Gasket Replaces: #94-5076	
	B4015-003	\$39.75
	Coil (Hot Coil) Replaces: #5-5011, AR12006, FXH2403, X5700, X5700B, X5700C	
	B4017-003	\$2.25
	Coil Clamp 2 used, each sold separately Replaces: #94-5080	
	B4017-004	\$8.50
	Coil Bar Replaces: #94-5066	
	B4017-005	\$3.50
	Inner Bearing Replaces: #24-5000	
	B4017-006	\$9.75
	Outer Bearing Replaces: #25-5000	
	B4017-046	\$2.75
	Bearing Cage Snap Ring Replaces: #43-5055	
	B4017-007	\$12.50
	Impulse Spring Replaces: #94-5016	
	B4017-008	\$6.25
	Stop Button Assembly Includes #B4017-009 Replaces: #90-5042 For the version with a Ground Wire, use #B4017-063 (\$7.26) instead.	
	B4017-009	\$2.25
	Stop Button Replaces: #94-5079	
	B4017-051	\$10.25
	WICO Impulse Catch Plate Replaces: #94-5070, FXH-210S-1	
	B4016-005	\$1.75
	Flange Gasket Replaces: #SAE	
	B4016-012	\$2.25
	Striker Plate Gasket Replaces: #94-5154	

	B4016-015	\$2.25
	Impulse Assembly Gasket Replaces: #94-5075	
	B9013-011	\$7.00
	WICO Series X Nameplate Fits the WICO Series X magneto (Rivets included)	



Wisconsin VD4, VE4, VF4, & VM4
with WICO Magneto #XH1343B (Y-54)

	B4011-004	\$17.75
	Points Replaces: #1-5008, 1-5111, FXH-2100B, FXH-2400B, X5996	
	B4012-002	\$13.75
	Condenser Replaces: #2-5007, X5614, X6916	
	B4013-032	\$38.00
	Cap Includes its own gasket Replaces: #3-5001	
	B4014-006	\$8.25
	Rotor Replaces: #4-5018, FXH1008, X5531	
	B4015-003	\$39.75
	Coil (Hot Coil) Replaces: #5-5011, AR12006, FXH2403, X5700, X5700B, X5700C	
	B4017-007	\$12.50
	Impulse Spring Replaces: #94-5016	
	B4017-051	\$10.25
	WICO Impulse Catch Plate Replaces: #94-5070, FXH-210S-1	

Wisconsin D2, D3, D4, D03, D04A, E, E2A, E0, E02,
E02A, GA, GA2, L2, L3, L4, M2, ZA, ZAZ
with WICO Magneto #XHD2900

	B4011-004	\$17.75
	Points Replaces: #1-5008, 1-5111, FXH-2100B, FXH-2400B, X5996	
	B4012-002	\$13.75
	Condenser Replaces: #2-5007, X5614, X6916	
	B4017-040	\$2.75
	Condenser Clamp Replaces: #94-5167	

	B4013-014	\$55.75
	Cap Replaces: #3-5015	
	B4014-008	\$30.00
	Rotor Replaces: #4-5004	
	B4016-004	\$2.25
	Cap Gasket Replaces: #94-5076	
	B4015-003	\$39.75
	Coil (Hot Coil) Replaces: #5-5011, AR12006, FXH2403, X5700, X5700B	
	B4017-003	\$2.25
	Coil Clamp 2 used, each sold separately Replaces: #94-5080	
	B4017-004	\$8.50
	Coil Bar Replaces: #94-5066	
	B4017-005	\$3.50
	Inner Bearing Replaces: #24-5000	
	B4017-006	\$9.75
	Outer Bearing Replaces: #25-5000	
	B4017-046	\$2.75
	Bearing Cage Snap Ring Replaces: #43-5055	
	B4017-007	\$12.50
	Impulse Spring Replaces: #94-5016	
	B4017-008	\$6.25
	Stop Button Assembly Includes #B4017-009 Replaces: #90-5042 For the version with a Ground Wire, use #B4017-063 (\$7.26) instead.	
	B4017-009	\$2.25
	Stop Button Replaces: #94-5079	
	B4017-051	\$10.25
	WICO Impulse Catch Plate Replaces: #94-5070, FXH-210S-1	
	B4016-005	\$1.75
	Flange Gasket Replaces: #SAE	

	B4016-012	\$2.25
	Striker Plate Gasket Replaces: #94-5154	
	B4016-015	\$2.25
	Impulse Assembly Gasket Replaces: #94-5075	
	B9013-011	\$7.00
	WICO Series X Nameplate Fits the WICO Series X magneto (Rivets included)	

11490, 11494, 11593, 11595, 11611, 11721, 11755, 11774, 11775, 11776, 12003, 12068, 12068A, 12095, 12096, 12098, 12158, 12188, 12199, 12205, 12229, 12234, 12235, 12236, 12238, 12239, 12253, 12288, 12325, 12449, 12488, 12517, 12522, 12544, 12566, 12744, 12748, 12775, 12780, 12300, 12375, 12599, 12982, 13047, 13096, 13098, 13099, 13105, 13110, 13166, 13201, 13206, 13238, 13271, 13286, 13308, 13309, 13405, 13420, 13422, 13452, 13453, 13455, 13549, 13653, 13694, 13727, 13729, 13730, 13733, 13749, 13751, 13780, 14544, S717, S717A, S717B, S717C, S732, S732A, S732D, S1162, S1164, S1329, S1329A, S1329C, S1548, S1548A, S1548B		
Wisconsin: #C-13, E-4, E-4N, L-48-1, L-48-2, L-48-3, L-48-16, L-48-AA, L-48-AB, L-48-AC, L-48-AD, L-48-AE, L-48-AF, L-48-AK, L-48-AL, L-48-AM, L-48-AU, L-48-AZ, L-48-B, L-48-BF, L-48-BF19, L-48-BF20, L-48-BP, L-48-C, L-48-C-2, L-48-D, L-48-E, L-48-F, L-48-G, L-48-H, L-48-J, L-48-JI, L-48-K, L-48-L, L-48-M, L-48-N, L-48-P, L-48-Q, L-48-U, L-48-V, L-48-VC, L-48-Y, L-48-Z, L-48-ZI, LZ-48-J-2, L-63, L-63-1, L-63-A, L-63-AF, L-63-AH, L-63-AJ, L-63-AN, L-63-AP, L-63-AQ, L-63-AU, L-63-AV, L-63-AZ, L-63-BC, L-63-BC-14, L-63-BJ, L-63-BL, L-63-BL-14, L-63-BM, L-63-BP, L-63-C, L-63-C-14, L-63-D, L-63-E, L-63-F, L-63-G, L-63-H, L-63-J, L-63-K, L-63-L, L-63-LA, L-63-M, L-63-R, L-63-U, L-63-V, LZ-48-7, LZ-48-18, LZ-48-26, LZ-63-2, LZ-63-11, LZ-63-14, LZ-63-AV2LZ-63-BC, LZ-63-BC-2, LZ-63-BL-2, LZ-63-C		

IDENTIFICATION TAGS

B9013-001	Small Autolite I.D. Tag (Blank)	\$7.00
	Small Autolite I.D. Tag (Stamped)	\$14.25
	2 5/16" Long, Black I.D. Tag for Distributors, Starters, & Generators with Rivets	

B9022-030	Zenith Rebuild Kit	\$47.75
	Wisconsin Replaces: LQ37 Fits: VG4D, V460D, VH4D, V465D, W4-1770 Fits Carburetor: Wisconsin: #L57-1, L57-E, L57G, L57H, L57K, L57L, L57M, L57M3, L-57R, L77-B, L77-C, L77G, L77H, L77-M, L120, LZ57-1, LZ77B, LZ77G, LZ-77L Zenith: #11532, 12708, 12825, 13339, 13401, 13714, 13821, 13863, 13866, 13884, 13904, 13925, 13991, 13992, 13993, 13995, 14119, 14131, 14160	

STARTER SWITCHES

B5006-001	Starter Switch (Long Shaft)	\$12.75
	6 or 12 Volt Panel Mounted Manual Push Start Switch Replaces: Delco - #192119, D900, 450C Prestolite - #15-121, 15-122, 15-409, 15-45, 15-47, 15-50, 15-51, SW-2916, SW-4001, SW-4002, SW-4005, SW-4010, SW-4013, SW-4015, SW-4017, SW-4101, SWX-47 Fits: Wisconsin - Various Models	

CARBURETOR FLOATS

B9022-009	Zenith Rebuild Kit	\$27.99
	Wisconsin Fits: AH Fits Zenith Carburetor #9402, 9402A, 11622, 11644 Massey Harris Carburetor: #L-43	

B9023-003	Marvel-Schebler Carburetor Float	\$12.75
	Wisconsin Tractors Model AGH, AGN, AGND, AHH, TC, TE, TF, TFD, TH, THD, THDM, THO, TJD, VD, VE, VE-3, VE-4, VF-4, VF-4D, VH-4, VH-4D, VH-4DM, VM4 Fits Marvel-Schebler Carburetor: #TSX-39, TSX-146, TSX-147, TSX-148, TSX-352, TSX-676, TSX-690, TSX-770, TSXU-829, TSXU-830, TSXU-834, TSX-865, TSX-914, TSX-919, TSX-954 Wisconsin Carburetor: #L-49, L-49-A, L-49-B, L-49-C, L-64-A, L-64-F, LZ-49-C, LZ-64-6, LZ-64-E-1 Replaces: Marvel Schebler: #30-600	

B9022-008	Zenith Rebuild Kit	\$26.95
	Wisconsin Fits: AEH, AEHS, AEN, AEND, AENL, AENLD, AENS, AFH, AGGH, AGN, AGND, AHH, HAENL, MTFD, MTHD, MVF-4D, MVFD-4D, MVH-4D, MVH-4MD, S8DB, TE, TEO, TF, TFH, TFM, TFO, TFS, TFT, TH, THD, THDM, THO, TJD, TRA-10D, TRA-12D, VD, VE, VE-4, VF-4, VF-4D, VH-4, VH-4D, VH-4DM Fits Carburetor: Zenith: #5632, 5632A, 5632B, 5632C, 10034, 10034A, 10034F, 10457, 10457A, 10457D, 10535, 10535A, 10535B, 10595, 10595A, 10595C, 10610, 10627, 10627A, 10627B, 10737, 10741, 10741A, 10741B, 10741C, 10748, 10748A, 10748D, 10788, 10788A, 10788B, 10816, 10816A, 10816B, 10858, 10858A, 10858B, 10858C, 10907, 10907A, 10907D, 10926, 10926A, 10932, 10932A, 10955, 10955A, 10955B, 10955C, 11003, 11003A, 11003B, 11003C, 11206, 11206A, 11372, 11372A,	

WORTHINGTON TRACTOR

4 Cyl. Worthington Tractor

B3048-001	Complete Wire Harness with Ford Model B Engine	\$63.75
------------------	---	----------------

AUTOMOTIVE & TRUCK

AMERICAN LAFRANCE

SPARK PLUG WIRE SETS



1962 American LaFrance Type 900 Series

Fire Truck with 6 Cyl Continental & Dual Ignition
6 Cyl. Tailored Spark Plug Wire Set

B1049-001	Original Type EPDM Wire	\$103.25
------------------	-------------------------	-----------------

TUNE UP PARTS

<u>American LaFrance</u> 1928-1934 w/ 8-Cylinder Lycoming Engine & Delco Distributor #650B		
	B4001-006 Points (Uses 2 Sets) Replaces: #1882022	\$11.75
	B4002-001 Condenser Replaces: #1928111, D-203, 1869704, D-200	\$4.75
	B4004-002 Rotor Replaces: #820445, D400	\$5.75
	B4003-002 Distributor Cap Premium Grade, Made in the USA (Brass Contacts) Replaces: #824735, D301	\$20.25
	B4006-001 Dust Cover Replaces: #1900119	\$9.99
	B4007-001 Cap Clip Short Mount, 1 Used Replaces: #1889967, 1847289, 453844, 453461	\$11.95
	B4007-002 Cap Clip Long Mount, 1 Used Replaces: #1889967, 1889999, 453844, 453461	\$11.95

	B4008-001 Distributor Insulator Replaces: #1904376	\$14.99
	B4009-001 Distributor Bushing & Shim Kit	\$25.99

<u>American LaFrance</u> 1936 w/ 8-Cylinder Lycoming Engine & Delco Distributor # 665F		
	B4001-006 Points Replaces: #1882022	\$11.75
	B4002-001 Condenser Replaces: #1928111, D-203, 1869704, D-200	\$4.75
	B4003-028 Cap Top Quality USA Made With Brass Contacts Replaces: #1911556, D-302	\$26.25
	B4004-018 Rotor Replaces: #1836893	\$5.75
	B4007-001 Cap Clip Short Mount, 1 Used Replaces: #1889967, 1847289, 453844, 453461	\$11.95
	B4007-002 Cap Clip Long Mount, 1 Used Replaces: #1889967, 1889999, 453844, 453461	\$11.95
	B4009-001 Distributor Bushing & Shim Kit	\$25.99

ELECTRONIC IGNITION CONVERSION KITS

Replaces Points & Condenser



American LaFrance

1928-1934 with 8-Cylinder Lycoming Engine
& Delco Distributor #650B

B9600-178	12 Volt Negative Ground	\$191.45
B9600-178P12	12 Volt Positive Ground	\$206.45



For Ignition Coils & Accessories, see
p.44

VOLTAGE REGULATORS

Note: Due to modern battery design, voltage regulators can't be used to charge low or dead batteries. Doing so will destroy the voltage regulator and void the warranty.

B8002-041	12-Volt Delco Voltage Regulator	\$78.75
------------------	--	----------------



12 Volt, 4 Terminal, Flat Mounting
(Premium Quality, Made in the USA)

American La France

Replaces:

Delco - #1118279, 1118339, 1118368,
1118838, 1118880, 1118881, 1118883,
1118939, 1119156, 1119200, 1119269,
1119607, D651

Fits: 1960-1964

AUBURN



BATTERY CABLES

Auburn Model 852 1936

B2000-008	Negative Ground Strap	\$15.50
------------------	-----------------------	----------------



TUNE UP PARTS

Auburn 6 Cylinder 1928 Model 76

	B4001-001	\$4.75
	Points Replaces: #D100HP, 1855720	
	B4004-002	\$5.75
	Rotor Replaces: #820445, D400	

*For 6-Volt Ignition Coils & Accessories, see p.44

Auburn 6 Cylinder 1929-1930

	B4100-001	\$10.50
	PCR Kit Includes: Points (#B4001-001), Condenser (#B4002-001), Rotor (#B4004-002) Replaces: Points - #D100HP, 1855720 Condenser - #1928111, D-203, 1869704, D-200 Rotor - #820445, D400	
	B4004-002	\$5.75
	Rotor Replaces: #820445, D400	

*For 6-Volt Ignition Coils & Accessories, see p.44

Auburn 6 Cylinder 1934-1936

	B4001-002	\$14.75
	Points Replaces: #IGW-3028S, 1-31	
	B4002-005	\$9.75
	Condenser Replaces: #2-24, 2-35, 2-22, 2-23	
	B4003-027	\$21.75
	Cap Replaces: #ICB-1240, 3-20	

	B4004-004	\$11.50
	Rotor Premium Grade, Made in the USA Replaces: #4-15, IGB-1239	

*For 6-Volt Ignition Coils & Accessories, see p.44

Auburn 8 Cylinder 1929-1930

	B4002-001	\$4.75
	Condenser Replaces: #1928111, D-203, 1869704, D-200	

	B4004-002	\$5.75
	Rotor Replaces: #820445, D400	

*For 6-Volt Ignition Coils & Accessories, see p.44

Auburn 8 Cylinder 1931-1933

	B4001-007	\$49.75
	Points Dual Point set Consists of 1 set each, left & right hand Replaces: #1882022	

	B4003-028	\$26.25
	Cap Top Quality USA Made With Brass Contacts Replaces: #1911556, D-302	

	B4004-018	\$5.75
	Rotor Replaces: #1836893	

	B4007-001	\$11.95
	Cap Clip Short Mount, 1 Used Replaces: #1889967, 1847289, 453844, 453461	

	B4007-002	\$11.95
	Cap Clip Long Mount, 1 Used Replaces: #1889967, 1889999, 453844, 453461	

	B4009-001	\$25.99
	Distributor Bushing & Shim Kit	

*For 6-Volt Ignition Coils & Accessories, see p.44

Auburn 8 Cylinder 1934-1936 (*Single Points*)

	B4001-002	\$14.75
	Points Replaces: #IGW-3028S, 1-31	

	B4002-002	\$4.75
	Condenser Replaces: #2-23, 2-31, 2-32, 2-34, 2-38, 2-42, IAT-2015L, IAT-2015R, IAT-3076AS, IAT-3076BS, IAT-3076D, IAT-3076DS, IAT-3076L, IAT-3076LA, IAT-3076R, IAT-3076RA, IBB-2015L, IBB-2015R, IBB-2042-SS, IBB-2042SS-1, IBB-2042-SS3, IG-2671F, IGH-3076, IGW-3139, 2098058, 3420600	

*For 6-Volt Ignition Coils & Accessories, see p.44

Auburn 8 Cylinder 1935-1936 (*Dual Points*)

	B4001-002	\$14.75
	Points Replaces: #IGW-3028S, 1-31	

*For 6-Volt Ignition Coils & Accessories, see p.44



For Ignition Coils & Accessories, see p.44

CUTOUT RELAYS & VOLTAGE REGULATORS

Note: Due to modern battery design, voltage regulators can't be used to charge low or dead batteries. Doing so will destroy the voltage regulator and void the warranty.

B8001-001	6-Volt Cutout Relay	\$19.50
	15 Amps, 6 Volt Works Positive or Negative Ground Replaces: Autolite - CB4014, C4012(9-5), C4012(9-4), C4012(9-1), R40061 Delco - #266P, 266N, 265P, 265N, 5015850, 812970, 265J, 820845, 812971, 1116816, 265G, 265H, 1116755, 1116751, 1116809DR, 265B, 1842859, 265C, 1867781, 265F, 265D Fits: Auburn - 6, 8 Cyl. all 1929-1936	

B8001-002	Electronic Cutout Relay	\$19.50
	25 Amp, Works with 6, 12, or 24 Volts, Positive or Negative Ground Replaces: Autolite - #CB4014, C4012(9-5), C4012(9-4), C4012(9-1), R40061 Delco - #266P, 266N, 265P, 265N, 5015850, 812970, 265J, 820845, 812971, 1116816, 265G, 265H, 1116755, 1116751, 1116809DR, 265B, 1842859, 265C, 1867781, 265F, 265D Fits: Auburn - 6, 8 Cyl. all 1929-1936	

BRUSH SETS

X324	12 Volt, 3 Brush Generator Set	\$8.25
	Consisting of 3 Brushes Generator Mounted Auburn Fits: 8 Cylinder All 1934-1936	

IDENTIFICATION TAGS

B9013-001	Small Autolite I.D. Tag (Blank)	\$7.00
	Small Autolite I.D. Tag (Stamped)	\$14.25
	2 5/16" Long, Black I.D. Tag for Distributors, Starters, & Generators with Rivets	
B9013-002	Large Autolite I.D. Tag (Blank)	\$7.00
	Large Autolite I.D. Tag (Stamped)	\$14.25
	2 15/16" Long, Black I.D. Tag for Distributors, Starters, & Generators with Rivets	

SWITCHES

B5010-018	Turn Signal Light Switch	\$73.50
	Universal Turn Signal Switch. Has right turn, left turn, and warning flasher modes. Metal Construction with Color Coded Wire Leads. Fuse, clamp ring, and instruction sheet included. Fits: Pre-1953 Vehicles	



ALTERNATORS

B6001-001	12 Volt Alternator (1 Wire)	\$112.75
63 Amp, Low Cut In, Specially Built For Tractors, Forklifts, & Other Low Engine Speed Applications		
B6001-005	6 Volt Alternator (1 Wire, Positive Ground)	\$166.50
6 Volt, 40 Amp Alternator with Positive Ground, 1 Wire, 3/8" pulley		

AUTOCAR TRUCK

SPARK PLUG WIRE SETS

Our Spark Plug Wire Sets Come **Fully Assembled with the Proper Type Wire & Terminals.**

They are Custom Tailored to Look & Fit Like Original Factory Equipment.



Varieties include:

Cotton Braid Wire: Copper Core with a Cotton Jacket.

EPDM Wire (E): Hi Performance Premium Conductor with a Tinned Copper Core, EPDM Silicone Insulation, and a Rubber Jacket.

Suppression Wire (S): for Electronic Ignition and is Spiral Wound, Ultra Low-Ohm, with EPDM Silicone Insulation and a Rubber Jacket.

Cotton Braid Suppression Wire (CS): also for Electronic Ignition, as Suppression Wire, but has an additional layer of Cotton Braid & Lacquer to replicate the vintage look, as well.

Autocar 1921-1929

4 Cyl. Tailored Spark Plug Wire Set

B1051-002	Original Type Cotton Braid Wire	\$55.00
B1051-002E	EPDM Wire	\$60.00

Autocar 1939-1954

With 377, 443, 501 Blue Streak Engine

6 Cyl. Tailored Spark Plug Wire Set

B1051-001	Original Type Cotton Braid Wire	\$68.75
B1051-001E	EPDM Wire	\$75.25
B1051-001S	Suppression Wire	\$75.25
B1051-001CS	Cotton Suppression wire	\$119.00

TUNE UP PARTS

Autocar 6 Cylinder 1939-1954

	B4100-001	\$10.50
PCR Kit Includes: Points (#B4001-001), Condenser (#B4002-001), Rotor (#B4004-002) Replaces: Points - #D100HP, 1855720 Condenser - #1928111, D-203, 1869704, D-200 Rotor - #820445, D400		
	B4004-002	\$5.75
Rotor Replaces: #820445, D400		
	B4003-002	\$20.25
Distributor Cap Premium Grade, Made in the USA (Brass Contacts) Replaces: #824735, D301		
B4006-001	Dust Cover Replaces: #1900119	\$9.99

	B4007-001	\$11.95
	Cap Clip Short Mount, 1 Used Replaces: #1889967, 1847289, 453844, 453461	
	B4007-002	\$11.95
	Cap Clip Long Mount, 1 Used Replaces: #1889967, 1889999, 453844, 453461	
	B4008-001	\$14.99
	Distributor Insulator Replaces: #1904376	
	B4009-001	\$25.99
	Distributor Bushing & Shim Kit	



For Ignition Coils & Accessories, see p.44

	B9013-005	Red Delco Remy I.D. Tag (Blank)	\$7.00
			(Stamped) \$14.25
		Red Delco-Remy I.D. Tag for 12 Volt Starters & 12 Volt Generators with Rivets, 3/4" 2 5/16"	
	B9013-006	Orange Delco Remy I.D. Tag (Blank)	\$7.00
			(Stamped) \$14.25
		Orange Delco-Remy I.D. Tag for 24 Volt Starters, & 24 Volt Generators with Rivets, 3/4" 2 5/16	
	B9013-013	Delco Remy I.D. Tag (Blank)	\$7.00
			Delco Remy I.D. Tag (Stamped) \$14.25
		Black Delco-Remy I.D. Tag for Distributors, 6 Volt Starters, & 6 Volt Generators with Rivets, 3/4" 2 5/16"	

SWITCHES

B5010-018	Turn Signal Light Switch	\$73.50
		Universal Turn Signal Switch. Has right turn, left turn, and warning flasher modes. Metal Construction with Color Coded Wire Leads. Fuse, clamp ring, and instruction sheet included. Fits: Pre-1953 Vehicles

VOLTAGE REGULATORS



Note: Due to modern battery design, voltage regulators can't be used to charge low or dead batteries. Doing so will destroy the voltage regulator and void the warranty.

B8002-041	12-Volt Delco Voltage Regulator	\$78.75
		12 Volt, 4 Terminal, Flat Mounting (Premium Quality, Made in the USA) Autocar Truck Replaces: Delco - #1118279, 1118339, 1118368, 1118838, 1118880, 1118881, 1118883, 1118939, 1119156, 1119200, 1119269, 1119607, D651 Fits: 1959-1960



ALTERNATORS



IDENTIFICATION TAGS

	B9013-001	Small Autolite I.D. Tag (Blank)	\$7.00
			Small Autolite I.D. Tag (Stamped) \$14.25
		2 5/16" Long, Black I.D. Tag for Distributors, Starters, & Generators with Rivets	
	B9013-002	Large Autolite I.D. Tag (Blank)	\$7.00
			Large Autolite I.D. Tag (Stamped) \$14.25
		2 15/16" Long, Black I.D. Tag for Distributors, Starters, & Generators with Rivets	

Delco Remy

	B9013-003	Large Delco Remy I.D. Tag (Blank)	\$9.00
			(Stamped) \$16.25
		Large Black Delco-Remy I.D. Tag for Distributors, 6 Volt Starters, & 6 Volt Generators with Rivets, 1 1/4" X 2 7/8"	
	B9013-004	Delco Remy I.D. Tag (Blank)	\$7.00
			Delco Remy I.D. Tag (Stamped) \$14.25
		Black Delco-Remy I.D. Tag for Distributors, 6 Volt Starters, & 6 Volt Generators with Rivets, 3/4" 2 5/16"	

B6001-001	12 Volt Alternator (1 Wire)	\$112.75
63 Amp, Low Cut In, Specially Built For Tractors, Forklifts, & Other Low Engine Speed Applications		
B6001-005	6 Volt Alternator (1 Wire, Positive Ground)	\$166.50
6 Volt, 40 Amp Alternator with Positive Ground, 1 Wire, 3/8" pulley		

BANTAM (AMERICAN & AUSTIN) **SPARK PLUG WIRE SETS**

American Bantam 1930-1934

4 Cyl. Tailored Spark Plug Wire Set

B1052-002	Original Type Cotton Braid Wire	\$36.50
------------------	---------------------------------	----------------

American Bantam 1938-1941

4 Cyl. Tailored Spark Plug Wire Set

B1052-001	Original Type Cotton Braid Wire	\$36.50
B1052-001E	EPDM Wire	\$39.75
B1052-001S	Suppression Wire	\$39.75
B1052-001CS	Cotton Suppression Wire	\$62.75

BATTERY CABLES

Austin 1930 – 1940

B2052-001	Negative Battery Cable	\$30.50
B2000-004	Positive Ground Strap	\$10.50

American 1940

B2000-004	Negative Ground Strap	\$10.50
B2052-002	Positive Battery Cable	\$26.50

Bantam 1940

B2000-004	Negative Ground Strap	\$10.50
B2052-003	Positive Battery Cable	\$32.25

TUNE UP PARTS

Bantam 1930-1934

with IGB 40384A-10M Autolite Distributor

	B4001-002 Points Replaces: #IGW-3028S, 1-31	\$14.75
	B4002-005 Condenser Replaces: #2-24, 2-35, 2-22, 2-23	\$9.75
	B4003-062 Cap Replaces: #IGB-1001, 3-14	\$21.50
	B4004-016 Rotor Premium Grade, USA Made Replaces: #IGB-1002, 4-12	\$9.50



*For 6-Volt Ignition Coils & Accessories, see p.44

Bantam 1938-1942

	B4001-002 Points Replaces: #IGW-3028S, 1-31	\$14.75
	B4002-005 Condenser Replaces: #2-24, 2-35, 2-22, 2-23	\$9.75
	B4003-027 Cap Replaces: #ICB-1240, 3-20	\$21.75
	B4004-004 Rotor Premium Grade, Made in the USA Replaces: #4-15, IGB-1239	\$11.50

*For 6-Volt Ignition Coils & Accessories, see p.44

IDENTIFICATION TAGS

	B9013-001 Small Autolite I.D. Tag (Blank)	\$7.00
	Small Autolite I.D. Tag (Stamped)	\$14.25
		2 5/16" Long, Black I.D. Tag for Distributors, Starters, & Generators with Rivets
	B9013-002 Large Autolite I.D. Tag (Blank)	\$7.00
	Large Autolite I.D. Tag (Stamped)	\$14.25
		2 15/16" Long, Black I.D. Tag for Distributors, Starters, & Generators with Rivets

ALTERNATORS

B6001-001	12 Volt Alternator (1 Wire)	\$112.75
63 Amp, Low Cut In, Specially Built For Tractors, Forklifts, & Other Low Engine Speed Applications		
B6001-006	6 Volt Alternator (1 Wire, Negative Ground)	\$166.50
6 Volt, 40 Amp Alternator with Negative Ground, 1 Wire		

Did You Know?

American Bantam's 1938 model was the inspiration for a famous duck's car.

BUICK CAR

TABLE OF CONTENTS

Spark Plug Wire Sets _____	410
Battery Cables _____	410
Tune Up Parts _____	412
Electronic Ignition Conversion Kits _____	414
Switches _____	414
Cutout Relays & Voltage Regulators _____	415
Identification Tags _____	415
Alternators _____	416
Starter Switches _____	416

SPARK PLUG WIRE SETS

Our Spark Plug Wire Sets Come Fully Assembled with the Proper Type Wire & Terminals.

They are Custom Tailored to Look & Fit Like Original Factory Equipment.

Varieties include:

Cotton Braid Wire: Copper Core with a Cotton Jacket.

Packard 440 Wire (P): Packard 440 Wire: Tinned Copper Core with EPDM Silicone Insulation and a Rubber Jacket.

Suppression Wire (S): for Electronic Ignition and is Spiral Wound, Low-Ohm, with EPDM Silicone Insulation and a Rubber Jacket.

Cotton Braid Suppression Wire (CS): also for Electronic Ignition, as Suppression Wire, but has an additional layer of Cotton Braid & Lacquer to replicate the vintage look, as well.



Buick 1912

4 Cyl. Tailored Spark Plug Wire Set

B1053-001	Original Type Cotton Braid Wire	\$50.75
------------------	--	----------------

Buick 1923

6 Cyl. Tailored Spark Plug Wire Set

B1053-008	Original Type Cotton Braid Wire	\$65.75
------------------	--	----------------

Buick 1925-1926 Master

6 Cyl. Tailored Spark Plug Wire Set

B1053-002	Original Type Cotton Braid Wire	\$62.50
------------------	--	----------------

Buick 1925-1927 Standard

6 Cyl. Tailored Spark Plug Wire Set

B1053-003	Original Type Cotton Braid Wire	\$56.25
------------------	--	----------------

Buick 1928 - 1930 Model 40

6 Cyl. Tailored Spark Plug Wire Set

B1053-007	Original Type Cotton Braid Wire	\$56.25
B1053-007P	Packard 440 Wire	\$159.50
B1053-007S	Suppression Wire	\$61.25
B1053-007CS	Cotton Suppression Wire	\$97.00

Buick 1929-1930 Models 50 & 60

6 Cyl. Tailored Spark Plug Wire Set

B1053-004	Original Type Cotton Braid Wire	\$56.25
B1053-004P	Packard 440 Wire	\$159.50
B1053-004S	Suppression Wire	\$61.25
B1053-004CS	Cotton Suppression Wire	\$97.00

Buick 1931-1952 (All Models) & 1953 Series 40 (Straight 8)

8 Cyl. Tailored Spark Plug Wire Set

B1053-005	Original Type Cotton Braid Wire	\$61.75
B1053-005P	Packard 440 Wire	\$175.00
B1053-005S	Suppression Wire	\$67.25
B1053-005CS	Cotton Suppression Wire	\$106.25

Buick 1953 Series 50-70 & 1954-1955 (V8)

8 Cyl. Tailored Spark Plug Wire Set

B1053-006	Original Type Packard 440 Wire	\$173.50
B1053-006S	Suppression Wire	\$66.75

BATTERY CABLES



Our Battery Cables are made from the Proper Gauge Copper, as either **Black Cotton Braided Wire** or **PVC Wire** (whichever is correct for the application), using Soldered & Heat Sealed Brass or Copper Terminals.

Buick 1925-26

B2000-004	Negative Ground Strap	\$10.50
B2053-001	Positive Battery Cable	\$36.75

Buick 1928-30

B2000-004	Negative Ground Strap	\$10.50
------------------	------------------------------	----------------

Buick 1928-1930

B2053-002	Positive Battery Cable	\$28.00
------------------	-------------------------------	----------------

Buick 1930-1931 Model 50

B2000-004	Negative Ground Strap	\$10.50
------------------	------------------------------	----------------

Buick 1930-1931 Model 60

B2000-004	Negative Ground Strap	\$10.50
B2053-003	Positive Battery Cable	\$40.25

Buick 1930-1931 Model 80

B2000-004	Negative Ground Strap	\$10.50
B2053-004	Positive Battery Cable	\$40.25

Buick 1930-1931 Model 90

B2000-004	Negative Ground Strap	\$10.50
B2053-005	Positive Battery Cable	\$40.25

Buick 1932 Model 50

B2000-006	Negative Ground Strap	\$13.50
B2053-033	Positive Battery Cable	\$49.25

Buick 1933-1935 Model 60

B2000-006	Negative Ground Strap	\$13.50
-----------	-----------------------	---------

Buick 1933-1935 Model 80

B2000-006	Negative Ground Strap	\$13.50
-----------	-----------------------	---------

Buick 1933-1935 Model 90

B2000-006	Negative Ground Strap	\$13.50
-----------	-----------------------	---------

Buick 1936-1937 Model 40

B2000-005	Negative Ground Strap	\$12.50
-----------	-----------------------	---------

Buick 1936-1937 Model 60

B2000-005	Negative Ground Strap	\$12.50
-----------	-----------------------	---------

Buick 1936-1937 Model 80

B2000-005	Negative Ground Strap	\$12.50
-----------	-----------------------	---------

Buick 1936-1937 Model 90

B2000-005	Negative Ground Strap	\$12.50
-----------	-----------------------	---------

Buick 1938-1940 Model 60

B2000-006	Negative Ground Strap	\$13.50
-----------	-----------------------	---------

B2053-006	Positive Battery Cable	\$24.00
-----------	------------------------	---------

Buick 1938-1940 Model 80

B2000-006	Negative Ground Strap	\$13.50
-----------	-----------------------	---------

B2053-007	Positive Battery Cable	\$28.00
-----------	------------------------	---------

Buick 1938-1940 Model 90

B2000-006	Negative Ground Strap	\$13.50
-----------	-----------------------	---------

B2053-008	Positive Battery Cable	\$28.00
-----------	------------------------	---------

Buick 1940 Model 40

B2000-006	Negative Ground Strap	\$13.50
-----------	-----------------------	---------

B2053-009	Positive Battery Cable	\$28.00
-----------	------------------------	---------

Buick 1940 Model 50

B2000-005	Negative Ground Strap	\$12.50
-----------	-----------------------	---------

B2053-010	Positive Battery Cable	\$30.00
-----------	------------------------	---------

Buick 1940 Model 60

B2000-005	Negative Ground Strap	\$12.50
-----------	-----------------------	---------

B2053-011	Positive Battery Cable	\$28.00
-----------	------------------------	---------

Buick 1940 Model 70

B2000-005	Negative Ground Strap	\$12.50
-----------	-----------------------	---------

B2053-012	Positive Battery Cable	\$30.00
-----------	------------------------	---------

Buick 1940-1942 Model 80

B2000-005	Negative Ground Strap	\$12.50
-----------	-----------------------	---------

B2053-013	Positive Battery Cable	\$28.00
-----------	------------------------	---------

Buick 1940-1942 Model 90

B2000-005	Negative Ground Strap	\$12.50
-----------	-----------------------	---------

B2053-014	Positive Battery Cable	\$28.00
-----------	------------------------	---------

Buick 1941-1947 Model 40

B2000-005	Negative Ground Strap	\$12.50
-----------	-----------------------	---------

B2053-015	Positive Battery Cable	\$28.00
-----------	------------------------	---------

Buick 1941-1947 Model 50

B2000-006	Negative Ground Strap	\$13.50
-----------	-----------------------	---------

B2053-016	Positive Battery Cable	\$28.00
-----------	------------------------	---------

Buick 1941-1947 Model 60

B2000-005	Negative Ground Strap	\$12.50
-----------	-----------------------	---------

B2053-017	Positive Battery Cable	\$28.00
-----------	------------------------	---------

Buick 1941-1947 Model 70

B2000-005	Negative Ground Strap	\$12.50
-----------	-----------------------	---------

B2053-018	Positive Battery Cable	\$28.00
-----------	------------------------	---------

Buick 1948-1950 All

B2000-004	Negative Ground Strap	\$10.50
-----------	-----------------------	---------

B2053-019	Positive Battery Cable	\$28.00
-----------	------------------------	---------

Buick 1951-1952 Model 40

B2000-005	Negative Ground Strap	\$12.50
-----------	-----------------------	---------

B2053-020	Positive Battery Cable	\$30.00
-----------	------------------------	---------

Buick 1951-1952 Model 50

B2000-005	Negative Ground Strap	\$12.50
-----------	-----------------------	---------

B2053-021	Positive Battery Cable	\$30.00
-----------	------------------------	---------

Buick 1951-1952 Model 70

B2000-004	Negative Ground Strap	\$10.50
-----------	-----------------------	---------

B2053-022	Positive Battery Cable	\$28.00
-----------	------------------------	---------

Buick 1953 Model 40

B2000-005	Negative Ground Strap	\$12.50
-----------	-----------------------	---------

B2053-023	Positive Battery Cable	\$30.00
-----------	------------------------	---------

Buick 1953 Model 50

B2000-005	Negative Ground Strap	\$12.50
-----------	-----------------------	---------

B2053-024	Positive Battery Cable	\$28.00
-----------	------------------------	---------

B2053-025	Switch to Starter Cable	\$37.75
-----------	-------------------------	---------

Buick 1953 Model 60

B2000-005	Negative Ground Strap	\$12.50
-----------	-----------------------	---------

B2053-026	Positive Battery Cable	\$28.00
-----------	------------------------	---------

B2053-027	Switch to Starter Cable	\$37.75
-----------	-------------------------	---------

Buick 1953 Model 70

B2000-005	Negative Ground Strap	\$12.50
-----------	-----------------------	---------

B2053-028	Positive Battery Cable	\$28.00
-----------	------------------------	---------

B2053-029	Switch to Starter Cable	\$37.75
-----------	-------------------------	---------

Buick 1954-1955 All

B2053-030	Negative Battery Cable	\$33.00
-----------	------------------------	---------



B2053-031	Positive Battery Cable	\$33.00
-----------	------------------------	---------

B2053-032	Switch to Starter Cable	\$41.75
-----------	-------------------------	---------

TUNE UP PARTS

Buick 6 Cylinder 1928-1930 Model 40 (All Single Point Distributors)		
	B4100-001	\$10.50
	PCR Kit Includes: Points (#B4001-001), Condenser (#B4002-001), Rotor (#B4004-002) Replaces: Points - #D100HP, 1855720 Condenser - #1928111, D-203, 1869704, D-200 Rotor - #820445, D400	
	B4004-002	\$5.75
	Rotor Replaces: #820445, D400	
	B4003-002	\$20.25
	Distributor Cap Premium Grade, Made in the USA (Brass Contacts) Replaces: #824735, D301	
	B4007-001	\$11.95
	Cap Clip Short Mount, 1 Used Replaces: #1889967, 1847289, 453844, 453461	
	B4007-002	\$11.95
	Cap Clip Long Mount, 1 Used Replaces: #1889967, 1889999, 453844, 453461	
	B4008-001	\$14.99
	Distributor Insulator Replaces: #1904376	
	B4009-001	\$25.99
	Distributor Bushing & Shim Kit	
B4006-001	Dust Cover Replaces: #1900119	\$9.99





*For 6- or 12-Volt Ignition Coils & Accessories, see p.44

Buick 6 Cylinder 1928-1930 Model 50, 60 (All Dual Point Distributors)		
	B4001-006	\$11.75
	Points (Uses 2 Sets) Replaces: #1882022	
	B4002-001	\$4.75
	Condenser Replaces: #1928111, D-203, 1869704, D- 200	



	B4004-002	\$5.75
	Rotor Replaces: #820445, D400	
	B4003-002	\$20.25
	Distributor Cap Premium Grade, Made in the USA (Brass Contacts) Replaces: #824735, D301	
	B4007-001	\$11.95
	Cap Clip Short Mount, 1 Used Replaces: #1889967, 1847289, 453844, 453461	
	B4007-002	\$11.95
	Cap Clip Long Mount, 1 Used Replaces: #1889967, 1889999, 453844, 453461	
	B4008-001	\$14.99
	Distributor Insulator Replaces: #1904376	
	B4009-001	\$25.99
	Distributor Bushing & Shim Kit	
B4006-001	Dust Cover Replaces: #1900119	\$9.99

*For 6- or 12-Volt Ignition Coils & Accessories, see p.44

Buick 6 Cylinder 1962-Early 1967 Even Fire		
	B4001-019	\$6.75
	Points Replaces: #D-106PS	
	B4002-001	\$4.75
	Condenser Replaces: #1928111, D-203, 1869704, D- 200	
	B4003-029	\$21.75
	Cap Replaces: #1957693	
	B4004-017	\$7.75
	Rotor Replaces: #1957684, D-413	

Buick 6 Cylinder Late 1967 Odd Fire		
	B4001-019	\$6.75
	Points Replaces: #D-106PS	
	B4002-001	\$4.75
	Condenser Replaces: #1928111, D-203, 1869704, D-200	
	B4003-030	\$20.25
	Cap Replaces: #1967286, D-326	
	B4004-017	\$7.75
	Rotor Replaces: #1957684, D-413	

Buick 6 Cylinder 1968-1974			
	B4100-003	\$9.75	
	PCR Kit Includes: Points (#B4001-012), Condenser (#B4002-012), Rotor (#B4004-013) Replaces: Points - #D108P Condenser - #D205 Rotor - #D-419R, 1963972		
		B4004-013	\$4.75
		Rotor Premium Grade, Made in the USA Replaces: #D-419R, 1963972	
	B4003-021	\$8.75	
	Distributor Cap Replaces: #1954569, D-316		
B4006-004	Dust Cover	Replaces: #1960325 \$16.99	



Buick 8 Cylinder 1931-1936 with Dual Points		
	B4001-007	\$49.75
	Points Dual Point set Consists of 1 set each, left & right hand Replaces: #1882022	
	B4002-001	\$4.75
	Condenser Replaces: #1928111, D-203, 1869704, D-200	
	B4003-028	\$26.25
	Cap Top Quality USA Made With Brass Contacts Replaces: #1911556, D-302	

	B4004-018	\$5.75
	Rotor Replaces: #1836893	
	B4007-001	\$11.95
	Cap Clip Short Mount, 1 Used Replaces: #1889967, 1847289, 453844, 453461	
	B4007-002	\$11.95
	Cap Clip Long Mount, 1 Used Replaces: #1889967, 1889999, 453844, 453461	
	B4009-001	\$25.99
	Distributor Bushing & Shim Kit	

*For 6- or 12-Volt Ignition Coils & Accessories, see p.44



Buick 8 Cylinder 1937-1953 Straight 8		
	B4001-013	\$16.25
	Points Replaces: #1938330 (D-103P), 1882024 (D103), 1871678, 1871870, 1918148	
	B4002-001	\$4.75
	Condenser Replaces: #1928111, D-203, 1869704, D-200	
	B4003-028	\$26.25
	Cap Top Quality USA Made With Brass Contacts Replaces: #1911556, D-302	
	B4004-018	\$5.75
	Rotor Replaces: #1836893	

*For 6-Volt Ignition Coils & Accessories, see p.44

Buick 8 Cylinder 1953 V8-1956		
	B4001-020	\$14.50
	Points Replaces: #1938340, 1882025, D104P, DR2437	
	B4002-001	\$4.75
	Condenser Replaces: #1928111, D-203, 1869704, D-200	
	B4003-031	\$17.50
	Cap Replaces: #O-305	

	B4004-019	\$10.50
	Rotor Replaces: #1917249, D-403	

*For 12-Volt Ignition Coils & Accessories, see p.44

Buick 8 Cylinder 1957-1974 All		
	B4001-019	\$6.75
	Points Replaces: #D-106PS	
	B4002-016	\$4.75
	Condenser Replaces: #1932004, D-204	
	B4003-032	\$14.25
	Cap Premium Quality, Brass Contacts Replaces: #1942654, D309	
	B4004-020	\$4.50
	Rotor Replaces: #1852722, 1932015, D-426R	

*For 12-Volt Ignition Coils & Accessories, see p.44

ELECTRONIC IGNITION CONVERSION KITS

Replaces Points & Condenser



Buick 6 Cyl. 1928-1930		
B9600-255LS	12 Volt Negative Ground	\$162.45
B9600-255LSN6	6 Volt Negative Ground	\$175.45
Buick 6 Cyl. 1962-1967 V6 with Odd Fire Engine		
B9600-016	12 Volt Negative Ground	\$139.95
Buick 6 Cyl. 1968-1974 All		
B9600-013A	12 Volt Negative Ground	\$124.95
Buick 8 Cyl. 1931-1956 with Mechanical Advance Under Breaker Plate		
B9600-184	12 Volt Negative Ground	\$154.95
B9600-184P6	6 Volt Positive Ground	\$169.45
B9600-184N6	6 Volt Negative Ground	\$169.45

Buick 8 Cyl. 1953-1956 All With Mechanical Advance under Breaker Plate (Lobe Sensor Version)		
B9600-023LS	12 Volt Negative Ground	\$132.95

Buick 8 Cyl. 1957-1974 (Lobe Sensor Version, Except 215, 300 Cid. Engine)		
B9600-021LS	12 Volt Negative Ground	\$132.95
B9600-021LSII	12 Volt Negative Ground with Upgraded Current Protection	\$175.95

Buick 8 Cyl. 1957-1974 All		
B9600-021	12 Volt Negative Ground	\$117.95



For Ignition Coils & Accessories, see p.44

SWITCHES

B5002-011	3-Position, 6-Volt Headlight Switch	\$57.75
	30 Amps, 6 Volt, 3 Position Headlight Switch. Has Four Screw Terminals. Two Stud Terminals. 5.5 Ohm Rheostat for Panel Lights & Circuit Braker. Includes Metal Knob, Shaft and Nut. Replaces: Delco - #1994016, 1994022, 1995031, 1995035, 1995041, 1995045, 1995048, D-1502, D1504 Fits: Buick - 1949-1953	

B5010-018	Turn Signal Light Switch	\$73.50
	Universal Turn Signal Switch. Has right turn, left turn, and warning flasher modes. Metal Construction with Color Coded Wire Leads. Fuse, clamp ring, and instruction sheet included. Fits: Pre-1953 Vehicles	

SOLENOIDS

B5007-042	6-Volt Delco Starter Solenoid Switch	\$52.75
	Replaces: Delco - #1114307, 1114310, 1114312, 1114410, 1118135, 1118140, 1118148, D936, D938, D939, D949, D964 Prestolite - #15-228, SWX-228, SWX-429 Fits: Buick - 8 Cyl. 1951-1953	

CUTOUT RELAYS & VOLTAGE REGULATORS

Note: Due to modern battery design, voltage regulators can't be used to charge low or dead batteries. Doing so will destroy the voltage regulator and void the warranty.

B8001-001	6-Volt Cutout Relay	\$19.50
	15 Amps, 6 Volt Works Positive or Negative Ground Replaces: Autolite - #CB4014, C4012(9-5), C4012(9-4), C4012(9-1), R40061 Delco - #266P, 266N, 265P, 265N, 5015850, 812970, 265J, 820845, 812971, 1116816, 265G, 265H, 1116755, 1116751, 1116809DR, 265B, 1842859, 265C, 1867781, 265F, 265D Fits: Buick - 6, 8 Cyl. All 1928-1933	

B8001-002	Electronic Cutout Relay	\$19.50
	25 Amp, Works with 6, 12, or 24 Volts. & Positive or Negative Ground Replaces: Autolite - #CB4014, C4012(9-5), C4012(9-4), C4012(9-1), R40061 Delco - #266P, 266N, 265P, 265N, 5015850, 812970, 265J, 820845, 812971, 1116816, 265G, 265H, 1116755, 1116751, 1116809DR, 265B, 1842859, 265C, 1867781, 265F, 265D Fits: Buick - 6, 8 Cyl. All 1928-1933	

6-Volt Saddle Mounted Cutout Relay (Delco Version)		
B8001-004	Premium Quality, Made in the USA	\$122.50
B8001-006	Standard Quality	\$38.59
	Cutout Relay, 25 Amp, 6 Volt, Works Positive or Negative Ground. Replaces: Delco - #266P, 266N, 265P, 265N, 5015850, 812970, 265J, 820845, 812971, 1116816, 265G, 265H, 1116755, 1116751, 1116809DR, 265B, 1842859, 265C, 1867781, 265F, 265D Fits: Buick - 6, 8 Cyl. All 1928-1933	

6-Volt Delco Type Voltage Regulator		
B8002-001	Premium Quality, Made in the USA	\$87.75
B8002-042	Standard Quality	\$34.75
	6-Volt, 3-Terminal, 32-42 Amps, Negative Ground, Flat Mounting Bracket, A-Circuit Replaces: Delco - 1118201, 1118300, 1118301, 1118357, 1118364, 1118721, 1118843, 1118847, 1118869, 1118872, D601, D614, D653 Fits: Buick - 1940-1949	

B8002-004	6-Volt Voltage Regulator	\$142.75
	6 Volt, 3 Terminal, Negative Ground, Voltage Regulator Replaces Delco #1118201, 1118207, 1118211, 1118216, 1118221, 1118233, 1118237, 1118242, 1118272, 1118301, 1118311, 1118313, 1118343, 1118349, 1118361, 1118720, 1118847, 1118866, 1118869, 1118872, 1118921, 5547, 5587, 5599, 5809, 5819, 5854, 5872, 5873, 5875, 5878, D601, D614, D653 Fits: Buick - 1950-1952, & 1953 Straight 8 All Except for #1102754 Generator Premium Quality, USA Made	

B8002-006	12-Volt Voltage Regulator	\$67.50
	12 Volt, 3 Terminal, Negative Ground, Voltage Regulator Fits: Buick - 1953 V8, 1954-1962 All with Generator Premium Quality, USA Made	

ALTERNATOR VOLTAGE REGULATORS

B8002-030	Alternator Voltage Regulator	\$14.50
	Heavy Duty, 12 Volt, Negative Ground Alternator Voltage Regulator. This external voltage regulator has 4 spade terminals (field, 2, 3, 4). It is designed for 'B' type circuits in negative ground systems. This is designed for use only in 12 volt systems. For Delco 10DN, & 20DN Replaces: Delco - #D630, D635, D663, 1119513, 1119515, 1119508, 1119519, D663, 1119502, 1119516, 1119506, 1119512, 1119515 Fits: Buick - 6, 8 Cyl. 1962, 6, 8 Cyl. 1963-1964, 8 Cyl. 1965-1969, 6, 8 Cyl. 1970-1971 (<i>Excluding Rivera</i>)	

IDENTIFICATION TAGS

B9013-003	Large Delco Remy I.D. Tag (Blank)	\$9.00
	Large Delco Remy I.D. Tag (Stamped)	\$16.25
	Large Black Delco-Remy I.D. Tag for Distributors, 6 Volt Starters, & 6 Volt Generators with Rivets, 1 1/4" X 2 7/8"	
B9013-004	Delco Remy I.D. Tag (Blank)	\$7.00
	Delco Remy I.D. Tag (Stamped)	\$14.25
	Black Delco-Remy I.D. Tag for Distributors, 6 Volt Starters, & 6 Volt Generators with Rivets, 3/4" 2 5/16"	
B9013-005	Red Delco Remy I.D. Tag (Blank)	\$7.00
	Red Delco Remy I.D. Tag (Stamped)	\$14.25
	Red Delco-Remy I.D. Tag for 12 Volt Starters & 12 Volt Generators with Rivets, 3/4" 2 5/16"	
B9013-013	Delco Remy I.D. Tag (Blank)	\$7.00
	Delco Remy I.D. Tag (Stamped)	\$14.25
	Black Delco-Remy I.D. Tag for Distributors, 6 Volt Starters, & 6 Volt Generators with Rivets, 3/4" 2 5/16"	

ALTERNATORS

B6001-001	12 Volt Alternator (1 Wire)	\$112.75	
63 Amp, Low Cut In, Specially Built For Tractors, Forklifts, & Other Low Engine Speed Applications			
B6001-002	12 Volt Alternator (1 or/3 Wire)	\$118.75	
63 Amp, With 1 Wire Or 3 Wire For Warning Lamp On Automobiles & Trucks			
B6001-006	6-Volt Alternator	\$166.50	
40 Amp, Negative Ground, 1-Wire			

STARTER SWITCHES

B5006-004	Starter Switch	\$11.75
	6 or 12 Volt Starter Mounted Manual Push Button Starter Switch Fits: Buick - 1931-1932	

BUICK TRUCK

SPARK PLUG WIRE SETS

Buick 1915

4 Cyl. Tailored Spark Plug Wire Set

B1054-001	Original Type Cotton Braid Wire	\$39.00
------------------	--	----------------

SWITCHES

B5002-011	3-Position, 6-Volt Headlight Switch	\$57.75
	30 Amps, 6 Volt, 3 Position Headlight Switch. Has Four Screw Terminals. Two Stud Terminals. 5.5 Ohm Rheostat for Panel Lights & Circuit Braker. Includes Metal Knob, Shaft and Nut. Replaces: Delco - #1994016, 1994022, 1995031, 1995035, 1995041, 1995045, 1995048, D-1502, D1504 Fits: Buick Truck - 1949-1953	

B5010-018	Turn Signal Light Switch	\$73.50
	Universal Turn Signal Switch. Has right turn, left turn, and warning flasher modes. Metal Construction with Color Coded Wire Leads. Fuse, clamp ring, and instruction sheet included. Fits: Pre-1953 Vehicles	

CADILLAC

TABLE OF CONTENTS

Spark Plug Wire Sets	416
Battery Cables	417
Tune Up Parts	418
Electronic Ignition Conversion Kits	419
Switches	419
Flashers	420
Cutout Relays & Voltage Regulators	420
Identification Tags	420
Alternators	421
Starter Switches	421

SPARK PLUG WIRE SETS

Our Spark Plug Wire Sets Come Fully Assembled with the Proper Type Wire & Terminals.

They are Custom Tailored to Look & Fit Like Original Factory Equipment.

Varieties include:

Cotton Braid Wire: Copper Core with a Cotton Jacket.

PVC Wire: Copper Core with a Rubber Jacket.

Packard 440 Wire (P): Tinned Copper Core with EPDM Silicone Insulation and a Rubber Jacket.

Suppression Wire (S): for Electronic Ignition and is Spiral Wound, Low-Ohm, with EPDM Silicone Insulation and a Rubber Jacket.

Cotton Braid Suppression Wire (CS): also for Electronic Ignition, as Suppression Wire, but has an additional layer of Cotton Braid & Lacquer to replicate the vintage look, as well.



Cadillac 1930 V16

16 Cyl. Tailored Spark Plug Wire Set

B1055-001	Original Type Cotton Braid Wire	\$132.50
B1055-001P	Packard 440 Wire	\$376.00

Cadillac 1937-1940

8 Cyl. Tailored Spark Plug Wire Set

B1055-002	Original Type Cotton Braid Wire	\$60.25
B1055-002P	Packard 440 Wire	\$188.50
B1055-002E	EPDM Wire	\$72.50
B1055-002S	Suppression Wire	\$72.50
B1055-002CS	Cotton Suppression Wire	\$114.75

Cadillac 1941-1947

8 Cyl. Tailored Spark Plug Wire Set

B1055-008	Original Type Cotton Braid Wire	\$66.50
B1055-008P	Packard 440 Wire	\$188.50
B1055-008S	Suppression Wire	\$72.50
B1055-008CS	Cotton Suppression Wire	\$114.75

Cadillac 1949-1951

8 Cyl. Tailored Spark Plug Wire Set

B1055-007	Original Type Cotton Braid Wire	\$66.50
B1055-007P	Packard 440 Wire	\$188.50
B1055-007S	Suppression Wire	\$72.50
B1055-007CS	Cotton Suppression Wire	\$114.75

Cadillac 1952-1953

8 Cyl. Tailored Spark Plug Wire Set

B1055-003	Original Type Packard 440 Wire	\$188.50
B1055-003S	Suppression Wire	\$72.50

Cadillac 1954-1958

8 Cyl. Tailored Spark Plug Wire Set

B1055-004	Original Type Packard 440 Wire	\$188.50
B1055-004S	Suppression Wire	\$72.50

Cadillac 1959-1962

8 Cyl. Tailored Spark Plug Wire Set

B1055-005	Original Type Packard 440 Wire	\$188.50
B1055-005S	Suppression Wire	\$72.50

Cadillac 1963-1974 Non HEI

8 Cyl. Tailored Spark Plug Wire Set

B1055-006	Original Type Packard 440 Wire	\$188.50
B1055-006E	EPDM Wire	\$72.50

BATTERY CABLES



Our Battery Cables are made from the Proper Gauge Copper, as either Black Cotton Braided Wire or PVC Wire (whichever is correct for the application), using Soldered & Heat Sealed Brass or Copper Terminals.

Cadillac 1930-1933 All

B2000-002	Positive Ground Strap	\$9.50
B2055-001	Negative Battery Cable	\$40.25

Cadillac 1937 Series 60 V8

B2000-004	Positive Ground Strap	\$10.50
B2055-033	Negative Battery Cable	\$71.50

Cadillac 1938 Series 60

B2000-004	Positive Ground Strap	\$10.50
------------------	------------------------------	----------------

Cadillac 1938 Series 65

B2000-004	Positive Ground Strap	\$10.50
------------------	------------------------------	----------------

Cadillac 1938 Series 75

B2000-006	Positive Ground Strap	\$13.50
------------------	------------------------------	----------------

Cadillac 1939-1940 Series 75

B2055-002	Negative Battery Cable	\$28.25
B2000-006	Positive Ground Strap	\$13.50

Cadillac 1940 Series 60S & 61

B2055-003	Negative Battery Cable	\$30.00
B2000-007	Positive Ground Strap	\$14.50

Cadillac 1940 Series 62 & 72 V8

B2055-004	Negative Battery Cable	\$55.75
B2000-005	Positive Ground Strap	\$12.50

Cadillac 1940 Series 90 V16

B2055-005	Negative Battery Cable	\$36.75
B2000-006	Positive Ground Strap	\$13.50

Cadillac 1941 Series 60S

B2055-006	Negative Battery Cable	\$27.50
B2000-008	Positive Ground Strap	\$15.50

Cadillac 1941 (All Except Series 60S)

B2055-007	Negative Battery Cable	\$27.50
B2000-005	Positive Ground Strap	\$12.50

Cadillac 1942 Series 60S, 62, & 72

B2055-030	Negative Battery Cable	\$27.50
B2000-008	Positive Ground Strap	\$15.50

Cadillac 1942 Series 61, 63, 67, & 75

B2055-010	Negative Battery Cable	\$27.50
B2000-005	Positive Ground Strap	\$12.50

Cadillac 1946-1947 Series 60S & 62

B2055-009	Positive Battery Cable	\$28.25
B2000-007	Negative Ground Strap	\$14.50

Cadillac 1946-47 Series 61, 63, 67, & 75

B2055-034	Positive Battery Cable	\$28.25
B2000-005	Negative Ground Strap	\$12.50

Cadillac 1948 (All)

B2055-011	Positive Battery Cable	\$28.25
B2000-005	Negative Ground Strap	\$12.50

Cadillac 1949

B2055-012	Positive Battery Cable	\$23.25
B2000-012	Negative Ground Strap, 2 Piece Construction	\$17.25

Cadillac 1950-1953

B2055-013	Positive Battery Cable	\$29.75
B2055-014	Negative Battery Cable Kit Includes Bonding Strap	\$31.75

Cadillac 1954-1955

B2055-015	Positive Battery Cable	\$26.25
B2055-016	Negative Battery Cable Kit Includes Bonding Strap	\$29.75

Cadillac 1956

B2055-017	Positive Battery Cable	\$22.00
B2055-018	Negative Battery Cable	\$25.00

Cadillac 1957

B2055-019	Positive Battery Cable	\$32.25
B2000-009	Negative Ground Strap	\$17.00

Cadillac 1958-1960

B2055-020	Positive Battery Cable	\$36.00
B2055-021	Negative Battery Cable	\$23.25

Cadillac 1961-1962

B2055-022	Positive Battery Cable	\$32.25
B2055-023	Negative Battery Cable	\$25.00

Cadillac 1963-1964

B2055-031	Positive Battery Cable	\$32.25
B2055-032	Negative Battery Cable	\$25.00

Cadillac 1965-1966

B2055-024	Positive Battery Cable	\$30.75
B2055-025	Negative Battery Cable	\$28.50

Cadillac 1967

B2055-026	Positive Battery Cable	\$30.75
B2055-027	Negative Battery Cable	\$22.50



Cadillac 1968

B2055-028	Positive Battery Cable	\$39.00
B2055-029	Negative Battery Cable	\$39.00

TUNE UP PARTS

Cadillac 8 Cylinder 1927-1931 Model 314

	B4001-007	\$49.75
	Points Dual Point set Consists of 1 set each, left & right hand Replaces: #1882022	
	B4002-001	\$4.75
	Condenser Replaces: #1928111, D-203, 1869704, D-200	
	B4003-028	\$26.25
	Cap Top Quality USA Made With Brass Contacts Replaces: #1911556, D-302	
	B4004-018	\$5.75
	Rotor Replaces: #1836893	
	B4007-001	\$11.95
	Cap Clip Short Mount, 1 Used Replaces: #1889967, 1847289, 453844, 453461	



	B4007-002	\$11.95
	Cap Clip Long Mount, 1 Used Replaces: #1889967, 1889999, 453844, 453461	
	B4009-001	\$25.99
	Distributor Bushing & Shim Kit	

Cadillac 8 Cylinder 1934-1939 & 16 Cyl. 1937-1940

	B4001-006	\$11.75
	Points Replaces: #1882022	
	B4002-001	\$4.75
	Condenser Replaces: #1928111, D-203, 1869704, D-200	
	B4003-028	\$26.25
	Cap Top Quality USA Made With Brass Contacts Replaces: #1911556, D-302	
	B4004-018	\$5.75
	Rotor Replaces: #1836893	
	B4007-001	\$11.95
	Cap Clip Short Mount, 1 Used Replaces: #1889967, 1847289, 453844, 453461	
	B4007-002	\$11.95
	Cap Clip Long Mount, 1 Used Replaces: #1889967, 1889999, 453844, 453461	
	B4009-001	\$25.99
	Distributor Bushing & Shim Kit	

<u>Cadillac 1951-1952</u>		
	B4001-013	\$16.25
	Points Replaces: #1938330 (D-103P), 1882024 (D103), 1871678, 1871870, 1918148	
	B4002-001	\$4.75
	Condenser Replaces: #1928111, D-203, 1869704, D-200	

	B4003-028	\$26.25
Cap Top Quality USA Made With Brass Contacts Replaces: #1911556, D-302		
	B4004-018	\$5.75
Rotor Replaces: #1836893		
	B4007-001	\$11.95
Cap Clip Short Mount, 1 Used Replaces: #1889967, 1847289, 453844, 453461		
	B4007-002	\$11.95
Cap Clip Long Mount, 1 Used Replaces: #1889967, 1889999, 453844, 453461		
	B4009-001	\$25.99
Distributor Bushing & Shim Kit		

	B4003-032	\$14.25
Cap Premium Quality, Brass Contacts Replaces: #1942654, D309		
	B4004-020	\$4.50
Rotor Replaces: #1852722, 1932015, D-426R		

*For 12-Volt Ignition Coils & Accessories, see p.44

ELECTRONIC IGNITION CONVERSION KITS

Replaces Points & Condenser



Cadillac 1953-1955		
	B4001-013	\$16.25
Points Replaces: #1938330 (D-103P), 1882024 (D103), 1871678, 1871870, 1918148		
	B4002-001	\$4.75
Condenser Replaces: #1928111, D-203, 1869704, D-200		
	B4003-031	\$17.50
Cap Replaces: #O-305		
	B4004-019	\$10.50
Rotor Replaces: #1917249, D-403		

Cadillac 8 Cyl. 1953-1955 All Lobe Sensor Version		
B9600-259LS	12 Volt Negative Ground	\$132.95



Cadillac 8 Cyl. 1938-1955 with Mechanical Advance Under Breaker Plate		
B9600-184	12 Volt Negative Ground	\$154.95
B9600-184P6	6 Volt Positive Ground	\$169.45
B9600-184N6	6 Volt Negative Ground	\$169.45

Cadillac 8 Cyl. 1956-1974 All		
B9600-021	12 Volt Negative Ground	\$117.95





For Ignition Coils & Accessories, see p.44

*For 12-Volt Ignition Coils & Accessories, see p.44

Cadillac 1956-1973 All		
	B4001-019	\$6.75
Points Replaces: #D-106PS		
	B4002-016	\$4.75
Condenser Replaces: #1932004, D-204		

SWITCHES

B5002-011	3-Position, 6-Volt Headlight Switch	\$57.75
 <p>30 Amps, 6 Volt, 3 Position Headlight Switch. Has Four Screw Terminals. Two Stud Terminals. 5.5 Ohm Rheostat for Panel Lights & Circuit Braker. Includes Metal Knob, Shaft and Nut. Replaces: Delco - #1994016, 1994022, 1995031, 1995035, 1995041, 1995045, 1995048, D-1502, D1504 Fits: Cadillac - 1948-1950</p>		

B5010-018	Turn Signal Light Switch	\$73.50
	Universal Turn Signal Switch. Has right turn, left turn, and warning flasher modes. Metal Construction with Color Coded Wire Leads. Fuse, clamp ring, and instruction sheet included. Fits: Pre-1953 Vehicles	

B8002-004	6-Volt Voltage Regulator	\$142.75
	6 Volt, 3 Terminal, Negative Ground, Voltage Regulator Fits: Cadillac - 1949-1952, & 1953 Replaces Delco #1118201, 1118207, 1118211, 1118216, 1118221, 1118233, 1118237, 1118242, 1118272, 1118301, 1118311, 1118313, 1118343, 1118349, 1118361, 1118720, 1118847, 1118866, 1118869, 1118872, 1118921, 5547, 5587, 5599, 5809, 5819, 5854, 5872, 5873, 5875, 5878, D601, D614, D653 Premium Quality/ USA Made	

FLASHERS

B9017-040	6-Volt Thermal Flasher	\$9.75
	6-Volt Thermal Flasher, Three Terminal Replaces: #535 Cadillac Fits: 1940-52	

B8002-006	12-Volt Voltage Regulator	\$67.50
	12 Volt, 3 Terminal, Negative Ground, Voltage Regulator Fits: Cadillac - 1953-1962 All Premium Quality/ USA Made	

CUTOUT RELAYS & VOLTAGE REGULATORS

Note: Due to modern battery design, voltage regulators can't be used to charge low or dead batteries. Doing so will destroy the voltage regulator and void the warranty.

B8001-001	6-Volt Cutout Relay	\$19.50
	15 Amps, 6 Volt Works Positive or Negative Ground Fits: Cadillac - All 1928-1931 (8, 12, 16 Cyl., All 1932-1933 (12, 16 Cyl.)	



ALTERNATOR VOLTAGE REGULATORS

B8002-003	Delco 6-Volt Voltage Regulator	\$119.75
	6 Volt, 3 Terminal, 26-30 Amps, Positive Ground, (Premium Quality/ USA Made) Replaces: Delco # 1118208, 1118215, 1118230, 1118234, 1118253, 1118271, 1118303, 1118350, 1118871, 1119176, 5559, 5596, 5597, 5810, 5811, 5813, 5818, 5828, 5831, 5861, 5865, 5867, 5874, D5865, D603 Fits: Cadillac 1937-1939	

B8002-030	Alternator Voltage Regulator	\$14.50
	Heavy Duty, 12 Volt, Negative Ground Alternator Voltage Regulator. This external voltage regulator has 4 spade terminals (field, 2, 3, 4). It is designed for 'B' type circuits in negative ground systems. This is designed for use only in 12 volt systems. For Delco 10DN, & 20DN Replaces: Delco - #D630, D635, D663, 1119513, 1119515, 1119508, 1119519, D663, 1119502, 1119516, 1119506, 1119512, 1119515 Fits: Cadillac - 8 Cyl. 1963-1964, 8 Cyl. 1965-1967, 8 Cyl. 1968-1969, 8 Cyl. 1970-1971 (<i>Excluding Eldorado</i>)	

6-Volt Delco Type Voltage Regulator		
B8002-001	Premium Quality, Made in the USA	\$87.75
B8002-042	Standard Quality	\$34.75
	6-Volt, 3-Terminal, 32-42 Amps, Negative Ground, Flat Mounting Bracket, A-Circuit Replaces: Delco - 1118201, 1118300, 1118301, 1118357, 1118364, 1118721, 1118843, 1118847, 1118869, 1118872, D601, D614, D653 Fits: Cadillac - 1946-1948	

IDENTIFICATION TAGS

B9013-003	Large Delco Remy I.D. Tag (Blank)	\$9.00
	Large Delco Remy I.D. Tag (Stamped)	\$16.25
		Large Black Delco-Remy I.D. Tag for Distributors, 6 Volt Starters, & 6 Volt Generators with Rivets, 1 1/4" X 2 7/8"
B9013-004	Delco Remy I.D. Tag (Blank)	\$7.00
	Delco Remy I.D. Tag (Stamped)	\$14.25
		Black Delco-Remy I.D. Tag for Distributors, 6 Volt Starters, & 6 Volt Generators with Rivets, 3/4" X 2 5/16"

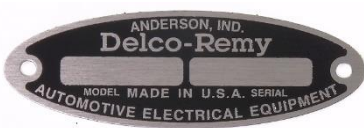
B9013-005	Red Delco Remy I.D. Tag (Blank)	\$7.00
	(Stamped)	\$14.25
		Red Delco-Remy I.D. Tag for 12 Volt Starters & 12 Volt Generators with Rivets, 3/4" 2 5/16"
B9013-013	Delco Remy I.D. Tag (Blank)	\$7.00
	(Stamped)	\$14.25
		Black Delco-Remy I.D. Tag for Distributors, 6 Volt Starters, & 6 Volt Generators with Rivets, 3/4" 2 5/16"



ALTERNATORS

B6001-001	12 Volt Alternator (1 Wire)	\$112.75
63 Amp, Low Cut In, Specially Built For Tractors, Forklifts, & Other Low Engine Speed Applications		
B6001-002	12 Volt Alternator (1 Wire/3 Wire)	\$118.75
63 Amp, With 1 Wire Or 3 Wire For Warning Lamp On Automobiles & Trucks		
B6001-005	6 Volt Alternator (1 Wire, Positive Ground)	\$166.50
6 Volt, 40 Amp Alternator with Positive Ground, 1 Wire, 3/8" pulley		
B6001-006	6 Volt Alternator (1 Wire, Negative Ground)	\$166.50
6 Volt, 40 Amp Alternator with Negative Ground, 1 Wire		

STARTER SWITCHES

B5006-004	Starter Switch	\$11.75
		6 or 12 Volt Starter Mounted Manual Push Button Starter Switch Fits: Cadillac - 1932-1933

SOLENOIDS

B5007-042	6-Volt Delco Starter Solenoid Switch	\$52.75
		Replaces: Delco - #1114307, 1114310, 1114312, 1114410, 1118135, 1118140, 1118148, D936, D938, D939, D949, D964 Prestolite - #15-228, SWX-228, SWX-429 Fits: Cadillac - 8 Cyl. 1950-1952

CAMERON

SPARK PLUG WIRE SETS

Our Spark Plug Wire Sets Come **Fully Assembled with the Proper Type Wire & Terminals.**

They are Custom Tailored to Look & Fit Like Original Factory Equipment.



Cameron 1905

4 Cyl. Tailored Spark Plug Wire Set

B1056-001	Original Type Cotton Braid Wire	\$25.75
B1056-001E	EPDM Wire	\$28.00

CHECKER

VOLTAGE REGULATORS

Note: Due to modern battery design, voltage regulators can't be used to charge low or dead batteries. Doing so will destroy the voltage regulator and void the warranty.

B8002-008	Autolite Type Voltage Regulator	\$69.75
		12 Volt, 3 Terminal, Flat Mounting Premium Quality/ USA Made Replaces: Prestolite - 8-154, 8-414, 8-58, 8-59, 8-722, 8-85, GRX-722, VBO-4201E, VBO-4202A, VBO-4202B, VBO-4202P, VBO-4202R, VR-6301A, VRX-6010, VRX-6010A Delco - 1972029, 1972061, A600, A600M, A605, A605M Fits: Checker - 1956-1960 w/ GAM, GHM Generator, 1958 w/ GGA Generator, 1961-1963 (Except GGA, GJP Generator)

CHEVROLET CAR

TABLE OF CONTENTS

Spark Plug Wire Sets	422
Battery Cables	423
Wire Harnesses	423
Tune Up Parts	423
Electronic Ignition Conversion Kits	426
Switches	427
Flashers	427
Cutout Relays & Voltage Regulators	427
Identification Tags, Alternators	428

Chevrolet 1955 (V8)

8 Cyl. Tailored Spark Plug Wire Set

B1057-003	Original Type Packard 440 Wire	\$157.00
B1057-003S	Suppression Wire	\$60.25

SEMI-TAILORED WIRE SETS

Semi-Tailored Spark Plug Wire Set for Chevrolet 305, 350, & 400 Small Block Engines, 1975 and up



- Made with Cotton Braided, Low-Ohm, Silicone Insulated Suppression Wire.
- Each Set Includes 8 Wires, 8 Terminals, & 8 Additional Boots.
- Available in Different Color Patterns (see below)

B1057-005-067CS	Black with Blue Cross Tracers	\$98.50
B1057-005-108CS	Black with (2) Orange Cross Tracers	\$98.50
B1057-005-073CS	Black with Red Cross Tracers	\$98.50
B1057-005-134CS	Black with (2) Red Cross Tracers	\$98.50
B1057-005-059CS	Black with (1) White Tracer	\$98.50
B1057-005-113CS	Green with Yellow Parallel Tracers	\$98.50
B1057-005-110CS	Orange with (1) Black Tracer	\$98.50
B1057-005-026CS	Orange (Oak) with Black & Red Cross Tracers	\$98.50
B1057-005-109CS	Red with Black & Yellow Cross Tracers	\$98.50
B1057-005-112CS	Yellow (Lemon Yellow) with (1) Black Tracer	\$98.50

Semi-Tailored Spark Plug Wire Set for Chevrolet LS Series Engines with 90 Degree Angle Boots

B1057-006-067CS	Black with Blue Cross Tracers	\$54.50
B1057-006-108CS	Black with (2) Orange Cross Tracers	\$54.50
B1057-006-073CS	Black with Red Cross Tracers	\$54.50
B1057-006-059CS	Black with (1) White Tracer	\$54.50
B1057-006-110CS	Orange with (1) Black Tracer	\$54.50
B1057-006-026CS	Orange (Oak) with Black & Red Cross Tracers	\$54.50
B1057-006-112CS	Yellow (Lemon Yellow) with (1) Black Tracer	\$54.50

Semi-Tailored Spark Plug Wire Set for Chevrolet LS Series Engines with 135 Degree Angle Boots

B1057-007-067CS	Black with Blue Cross Tracers	\$54.50
B1057-007-108CS	Black with (2) Orange Cross Tracers	\$54.50
B1057-007-073CS	Black with Red Cross Tracers	\$54.50
B1057-007-059CS	Black with (1) White Tracer	\$54.50
B1057-007-110CS	Orange with (1) Black Tracer	\$54.50
B1057-007-026CS	Orange (Oak) with Black & Red Cross Tracers	\$54.50
B1057-007-112CS	Yellow (Lemon Yellow) with (1) Black Tracer	\$54.50
B1057-007-111CS	Yellow (Lemon Yellow) with Red & Black Cross Tracers	\$54.50

SPARK PLUG WIRE SETS

Our Spark Plug Wire Sets Come Fully Assembled with the Proper Type Wire & Terminals.

They are Custom Tailored to Look & Fit Like Original Factory Equipment.

Varieties include:

Cotton Braid Wire: Copper Core with a Cotton Jacket.

PVC Wire: Copper Core with a Rubber Jacket.

Packard 440 Wire (P): Tinned Copper Core with EPDM Silicone Insulation and a Rubber Jacket.

Suppression Wire (S): for Electronic Ignition and is Spiral Wound, Low-Ohm, with EPDM Silicone Insulation and a Rubber Jacket.

Cotton Braid Suppression Wire (CS): also for Electronic Ignition, as Suppression Wire, but has an additional layer of Cotton Braid & Lacquer to replicate the vintage look, as well..



Chevrolet 1927-1928

4 Cyl. Tailored Spark Plug Wire Set

B1057-004	Original Type Cotton Braid Wire	\$44.50
B1057-004P	Packard 440 Wire	\$126.00
B1057-004S	Suppression Wire	\$48.50
B1057-004CS	Cotton Suppression Wire	\$77.00

Chevrolet 1929-1940

6 Cyl. Tailored Spark Plug Wire Set

B1057-001	Original Type Cotton Braid Wire	\$38.00
B1057-001P	Packard 440 Wire	\$107.75
B1057-001E	EPDM Wire	\$41.50
B1057-001S	Suppression Wire	\$41.50
B1057-001CS	Cotton Suppression Wire	\$65.75

Chevrolet 1941-1955

6 Cyl. Tailored Spark Plug Wire Set

B1057-002	Original Type Cotton Braid Wire	\$35.00
B1057-002P	Packard 440 Wire	\$99.25
B1057-002E	EPDM Wire	\$38.25
B1057-002S	Suppression Wire	\$38.25
B1057-002CS	Cotton Suppression Wire	\$60.50

BATTERY CABLES



Our Battery Cables are made from the Proper Gauge Copper, as either Black Cotton Braided Wire or PVC Wire (whichever is correct for the application), using Soldered & Heat Sealed Brass or Copper Terminals.

Chevrolet 1917-1919 Model 490

B2057-012	Positive Battery Cable	\$50.50
B2057-013	Negative Battery Cable	\$36.50
B2057-014	Switch to Starter Cable	\$29.25

Chevrolet 1926-1928 Except Standard

B2057-001	Positive Battery Cable	\$32.00
------------------	------------------------	----------------

Chevrolet 1929-1932

B2057-002	Positive Battery Cable	\$37.75
B2000-004	Negative Ground Strap	\$10.50

Chevrolet 1933-1936 Except Standard

B2057-003	Positive Battery Cable	\$40.25
------------------	------------------------	----------------

Chevrolet 1936 Standard

B2057-004	Positive Battery Cable	\$41.50
B2000-006	Negative Ground Strap	\$13.50

Chevrolet 1936-1939 Except Standard

B2000-006	Negative Ground Strap	\$13.50
------------------	-----------------------	----------------

Chevrolet 1940-1948

B2057-005	Positive Battery Cable	\$28.75
B2000-007	Negative Ground Strap	\$14.50

Chevrolet 1949-1952

B2057-006	Positive Battery Cable	\$48.50
B2000-007	Negative Ground Strap	\$14.50

Chevrolet 1953-1954 Except Corvette

B2057-008	Positive Battery Cable	\$48.50
------------------	------------------------	----------------

Chevrolet 1953-1954 Corvette

B2057-011	Positive Battery Cable	\$48.50
B2000-008	Negative Ground Strap	\$15.50

Chevrolet 6 Cyl. 1955

B2057-009	Positive Battery Cable	\$42.25
B2000-004	Negative Ground Strap	\$10.50

Chevrolet 8 Cyl. 1955

B2057-010	Positive Battery Cable	\$50.00
B2000-004	Negative Ground Strap	\$10.50



WIRING HARNESSES

Our Wire Harnesses are made with our premium cotton braid and/or PVC wire. They have the correct gauge, color, wire, & fuse holders (if needed). All terminals are soldered according to the original.

(Harnesses do not include Battery Cables & Spark Plug Wires; however, we can supply these as separate products.)



NO HIDDEN COSTS, NOTHING EXTRA TO BUY!



Chevrolet Car 1917 - 1919 Model 490

B3057-001	Complete Wire Harness	Light Connectors & Junction Boxes Not Included	340.00
------------------	-----------------------	--	---------------

TUNE UP PARTS

Chevrolet 4 Cylinder 1927-1928
with Delco Distributor #635B

	B4001-021	\$13.75
	Points Replaces: #1855520, D-109	
	B4002-001	\$4.75
	Condenser Replaces: #1928111, D-203, 1869704, D-200	

	B4004-021	\$14.75
	Rotor Replaces: #816774	
	B4003-033	\$25.50
	Cap Replaces: #811589, 1835536, 821589, 818425	

*For 6-Volt Ignition Coils & Accessories, see p.44

Chevrolet 4 Cylinder 1962-1974		
	B4100-003	\$9.75
	PCR Kit Includes: Points (#B4001-012), Condenser (#B4002-012), Rotor (#B4004-013) Replaces: Points - #D108P Condenser - #D205 Rotor - #D-419R, 1963972	
	B4004-013	\$4.75
	Rotor Premium Grade, Made in the USA Replaces: #D-419R, 1963972	
	B4003-015	\$16.25
	Distributor Cap Brass Contacts Replaces: #D-322	
B4006-004	Dust Cover	Replaces: #1960325 \$16.99

Chevrolet 6 Cylinder 1929-1932 (Single Point with Delco #633J Distributor)		
	B4001-021	\$13.75
	Points Replaces: #1855520, D-109	
	B4002-001	\$4.75
	Condenser Replaces: #1928111, D-203, 1869704, D-200	
	B4004-021	\$14.75
	Rotor Replaces: #816774	
	B4003-059	\$22.50
	Cap Replaces: #816779, 822465, 1831800, 1853240	

*For 6-Volt Ignition Coils & Accessories, see p.44

Chevrolet 6 Cylinder 1933-1952 (Except 1933-1934 Standard, 1941-1948)		
	B4100-001	\$10.50
	PCR Kit Includes: Points (#B4001-001), Condenser (#B4002-001), Rotor (#B4004-002) Replaces: Points - #D100HP, 1855720 Condenser - #1928111, D-203, 1869704, D-200 Rotor - #820445, D400	

	B4004-002	\$5.75
	Rotor Replaces: #820445, D400	
	B4003-002	\$20.25
	Distributor Cap Premium Grade, Made in the USA (Brass Contacts) Replaces: #824735, D301	
	B4007-001	\$11.95
	Cap Clip Short Mount, 1 Used Replaces: #1889967, 1847289, 453844, 453461	
	B4007-002	\$11.95
	Cap Clip Long Mount, 1 Used Replaces: #1889967, 1889999, 453844, 453461	
	B4008-001	\$14.99
	Distributor Insulator Replaces: #1904376	
	B4009-001	\$25.99
	Distributor Bushing & Shim Kit	
B4006-001	Dust Cover	Replaces: #1900119 \$9.99

*For 6-or 12-Volt Ignition Coils & Accessories, see p.44

Chevrolet 6 Cylinder 1941-1952 All		
	B4001-006	\$11.75
	Points Replaces: #1882022	
	B4002-001	\$4.75
	Condenser Replaces: #1928111, D-203, 1869704, D-200	
	B4004-002	\$5.75
	Rotor Replaces: #820445, D400	
	B4003-002	\$20.25
	Distributor Cap Premium Grade, Made in the USA (Brass Contacts) Replaces: #824735, D301	
	B4007-001	\$11.95
	Cap Clip Short Mount, 1 Used Replaces: #1889967, 1847289, 453844, 453461	

	B4007-002	\$11.95
Cap Clip Long Mount, 1 Used Replaces: #1889967, 1889999, 453844, 453461		
	B4008-001	\$14.99
Distributor Insulator Replaces: #1904376		
	B4009-001	\$25.99
Distributor Bushing & Shim Kit		
B4006-001	Dust Cover	Replaces: #1900119 \$9.99



*For 6-or 12-Volt Ignition Coils & Accessories, see p.44

Chevrolet 6 Cylinder 1953-1954 All (6-Volt)
 6 Cylinder 1955-1962 All (12-Volt)

	B4001-001	\$4.75
Points Replaces: #D100HP, 1855720		
	B4002-001	\$4.75
Condenser Replaces: #1928111, D-203, 1869704, D-200		
	B4003-034	\$18.25
Cap Replaces: #268574C92		
	B4004-022	\$6.50
Rotor Replaces: #1924245, D-405		

*For 6- or 12-Volt Ignition Coils & Accessories, see p.44

Chevrolet 6 Cylinder 1963-1974

	B4100-003	\$9.75
PCR Kit Includes: Points (#B4001-012), Condenser (#B4002-012), Rotor (#B4004-013) Replaces: Points - #D108P Condenser - #D205 Rotor - #D-419R, 1963972		
	B4004-013	\$4.75
Rotor Premium Grade, Made in the USA Replaces: #D-419R, 1963972		

	B4003-021	\$8.75
Distributor Cap Replaces: #1954569, D-316		

B4006-004	Dust Cover	Replaces: #1960325 \$16.99
------------------	-------------------	-----------------------------------

*For 6-or 12-Volt Ignition Coils & Accessories, see p.44

Chevrolet 8 Cylinder 1955-1956 All (Except Corvette)

	B4001-020	\$14.50
Points Replaces: #1938340, 1882025, D104P, DR2437		
	B4002-001	\$4.75
Condenser Replaces: #1928111, D-203, 1869704, D-200		
	B4003-031	\$17.50
Cap Replaces: #O-305		
	B4004-023	\$4.75
Rotor Replaces: #1927393, D-407		

*For 12-Volt Ignition Coils & Accessories, see p.44



Chevrolet 8 Cylinder 1956-1958 Corvette



	B4001-013	\$16.25
Points Replaces: #1938330 (D-103P), 1882024 (D103), 1871678, 1871870, 1918148		
	B4002-001	\$4.75
Condenser Replaces: #1928111, D-203, 1869704, D-200		
	B4003-031	\$17.50
Cap Replaces: #O-305		
	B4004-023	\$4.75
Rotor Replaces: #1927393, D-407		



*For 12-Volt Ignition Coils & Accessories, see p.44

Chevrolet 8 Cylinder 1957-1958 all (Except Corvette)		
	B4001-019	\$6.75
	Points Replaces: #D-106PS	
	B4002-016	\$4.75
	Condenser Replaces: #1932004, D-204	
	B4003-032	\$14.25
	Cap Premium Quality, Brass Contacts Replaces: #1942654, D309	
	B4004-020	\$4.50
	Rotor Replaces: #1852722, 1932015, D-426R	

*For 12-Volt Ignition Coils & Accessories, see p.44

Chevrolet 8 Cylinder 1958-1962 with F.I., Dual Points, used with Delco Distributor #1110914		
	B4001-019	\$6.75
	Points Replaces: #D-106PS	
	B4003-060	\$33.00
	Cap Premium Grade, Made in the USA Replaces: #1941551, D324	
	B4004-020	\$4.50
	Rotor Replaces: #1852722, 1932015, D-426R	

Chevrolet 8 Cylinder 1959-1974 (Except 1962-1965 With 409" Engine)		
	B4001-019	\$6.75
	Points Replaces: #D-106PS	
	B4002-016	\$4.75
	Condenser Replaces: #1932004, D-204	

	B4003-032	\$14.25
	Cap Premium Quality, Brass Contacts Replaces: #1942654, D309	
	B4004-020	\$4.50
	Rotor Replaces: #1852722, 1932015, D-426R	

*For 12-Volt Ignition Coils & Accessories, see p.44

ELECTRONIC IGNITION CONVERSION KITS

Replaces Points & Condenser



Chevrolet 4 Cyl. 1927-1929 with Delco 635B, 635J Distributors		
B9600-311	12 Volt Negative Ground	\$154.95
B9600-311P6	6 Volt Positive Ground	\$165.45

Chevrolet 4 Cyl. 1962-1974 All		
B9600-008A	12 Volt Negative Ground	\$134.45

Chevrolet 4 Cyl. 1974-1975 LUV Pickup		
B9600-087	12 Volt Negative Ground	\$132.95

Chevrolet 6 Cyl. 1929-1934 All with Single Point Delco #622L, 633J, 633G, 633U Distributors		
B9600-309	12 Volt Negative Ground	\$154.95
B9600-309N6	6 Volt Negative Ground	\$169.45

Chevrolet 6 Cyl. 1933 -1962 All		
B9600-255LS	12 Volt Negative Ground	\$162.45
B9600-255LSN6	6 Volt Negative Ground	\$175.45

Chevrolet 6 Cyl. 1963-1974		
B9600-013A	12 Volt Negative Ground	\$124.95

Chevrolet 8 Cyl. 1955-1958 All with Single or Dual Point Distributor & Mechanical Advance Under Breaker Plate		
B9600-184	12 Volt Negative Ground	\$154.95
B9600-184N6	6 Volt Negative Ground	\$169.45

Chevrolet 8 Cyl. 1957-1974 All		
B9600-021	12 Volt Negative Ground	\$117.95

Chevrolet 8 Cyl. 1957-1974 Lobe Sensor Version		
B9600-021LS	12 Volt Negative Ground	\$132.95
B9600-021LSII	12 Volt Negative Ground with Upgraded Current Protection	\$175.95



For Ignition Coils & Accessories, see p.44

SWITCHES

B5002-011	3-Position, 6-Volt Headlight Switch	\$57.75
	30 Amps, 6 Volt, 3 Position Headlight Switch. Has Four Screw Terminals. Two Stud Terminals. 5.5 Ohm Rheostat for Panel Lights & Circuit Braker. Includes Metal Knob, Shaft and Nut. Replaces: Delco - #1994016, 1994022, 1995031, 1995035, 1995041, 1995045, 1995048, D-1502, D1504 Fits: Chevrolet Car - 1948-1950	

B5010-018	Turn Signal Light Switch	\$73.50
	Universal Turn Signal Switch. Has right turn, left turn, and warning flasher modes. Metal Construction with Color Coded Wire Leads. Fuse, clamp ring, and instruction sheet included. Fits: Chevrolet Car - Pre-1953	

SOLENOIDS

B5007-042	6-Volt Delco Starter Solenoid Switch	\$52.75
	Replaces: Delco - #1114307, 1114310, 1114312, 1114410, 1118135, 1118140, 1118148, D936, D938, D939, D949, D964 Prestolite - #15-228, SWX-228, SWX-429 Fits: Chevrolet Car - 6 Cyl. 1953-1954 (3.8L Corvette), 6 Cyl. 1949-1954 All	

FLASHERS

B9017-040	6-Volt Thermal Flasher	\$9.75
	6-Volt Thermal Flasher, Three Terminal Replaces: #535 Chevrolet Fits: 1948-54	

CUTOUT RELAYS & VOLTAGE REGULATORS

Note: Due to modern battery design, voltage regulators can't be used to charge low or dead batteries. Doing so will destroy the voltage regulator and void the warranty.

B8001-001	6-Volt Cutout Relay	\$19.50
	15 Amps, 6 Volt Works Positive or Negative Ground Replaces: Autolite - CB4014, C4012(9-5), C4012(9-4), C4012(9-1), R40061 Delco - #266P, 266N, 265P, 265N, 5015850, 812970, 265J, 820845, 812971, 1116816, 265G, 265H, 1116755, 1116751, 1116809DR, 265B, 1842859, 265C, 1867781, 265F, 265D Fits: Chevrolet - 1928 - 1939	

B8001-002	Electronic Cutout Relay	\$19.50
	25 Amp, Works with 6, 12, or 24 Volts. & Positive or Negative Ground Replaces: Autolite - #CB4014, C4012(9-5), C4012(9-4), C4012(9-1), R40061 Delco - #266P, 266N, 265P, 265N, 5015850, 812970, 265J, 820845, 812971, 1116816, 265G, 265H, 1116755, 1116751, 1116809DR, 265B, 1842859, 265C, 1867781, 265F, 265D Fits: Chevrolet - 1928 - 1939	

6-Volt Saddle Mounted Cutout Relay (Delco Version)		
B8001-004	Premium Quality, Made in the USA	\$122.50
B8001-006	Standard Quality	\$38.59
	Cutout Relay, 25 Amp, 6 Volt, Works Positive or Negative Ground. Replaces: Delco - #266P, 266N, 265P, 265N, 5015850, 812970, 265J, 820845, 812971, 1116816, 265G, 265H, 1116755, 1116751, 1116809DR, 265B, 1842859, 265C, 1867781, 265F, 265D Fits: Chevrolet - 1928 - 1939	

6-Volt Delco Type Voltage Regulator		
B8002-001	Premium Quality, Made in the USA	\$87.75
B8002-042	Standard Quality	\$34.75
	6-Volt, 3-Terminal, 32-42 Amps, Negative Ground, Flat Mounting Bracket, A-Circuit Replaces: Delco - 1118201, 1118300, 1118301, 1118357, 1118364, 1118721, 1118843, 1118847, 1118869, 1118872, D601, D614, D653 Fits: Chevrolet Car - 1940-1952	

B8002-004	6-Volt Voltage Regulator	\$142.75
	6 Volt, 3 Terminal, Negative Ground, Voltage Regulator Fits: Chevrolet - 1953-1954 All Replaces: Delco - #1118201, 1118207, 1118211, 1118216, 1118221, 1118233, 1118237, 1118242, 1118272, 1118301, 1118311, 1118313, 1118343, 1118349, 1118361, 1118720, 1118847, 1118866, 1118869, 1118872, 1118921, 5547, 5587, 5599, 5809, 5819, 5854, 5872, 5873, 5875, 5878, D601, D614, D653 PREMIUM QUALITY- USA MADE	

B8002-006	12-Volt Voltage Regulator	\$67.50
	12 Volt, 3 Terminal, Negative Ground, Voltage Regulator Fits: Chevrolet - 1955-1958 PREMIUM QUALITY- USA MADE	

B8002-007	12-Volt Voltage Regulator	\$125.50
	12 Volt, 3 Terminal, Negative Ground, Voltage Regulator Fits: Chevrolet - 1959-1962 PREMIUM QUALITY- USA MADE	

ALTERNATOR VOLTAGE REGULATORS

B8002-030	Alternator Voltage Regulator	\$14.50
	Heavy Duty, 12 Volt, Negative Ground Alternator Voltage Regulator. This external voltage regulator has 4 spade terminals (field, 2, 3, 4). It is designed for 'B' type circuits in negative ground systems. This is designed for use only in 12 volt systems. For Delco 10DN, & 20DN Fits: Chevrolet (Car) - 4, 6, 8 Cyl. 1963-1964, 4, 6, 8 Cyl. 1965-1968, 4 Cyl. 1969, 6, 8 Cyl. 1969, 4 Cyl. 1970, 8 Cyl. 1970-1971, 6, 8 Cyl. 1970-1971, 6, 8 Cyl. 1963-1964 Replaces: Delco - #D630, D635, D663, 1119513, 1119515, 1119508, 1119519, D663, 1119502, 1119516, 1119506, 1119512, 1119515	

IDENTIFICATION TAGS

B9013-003	Large Delco Remy I.D. Tag (Blank)	\$9.00
	Large Delco Remy I.D. Tag (Stamped)	\$16.25
	Large Black Delco-Remy I.D. Tag for Distributors, 6 Volt Starters, & 6 Volt Generators with Rivets, 1 1/4" X 2 7/8"	
B9013-004	Delco Remy I.D. Tag (Blank)	\$7.00
	Delco Remy I.D. Tag (Stamped)	\$14.25
	Black Delco-Remy I.D. Tag for Distributors, 6 Volt Starters, & 6 Volt Generators with Rivets, 3/4" 2 5/16"	
B9013-005	Red Delco Remy I.D. Tag (Blank)	\$7.00
	Red Delco Remy I.D. Tag (Stamped)	\$14.25
	Red Delco-Remy I.D. Tag for 12 Volt Starters & 12 Volt Generators with Rivets, 3/4" 2 5/16"	
B9013-013	Delco Remy I.D. Tag (Blank)	\$7.00
	Delco Remy I.D. Tag (Stamped)	\$14.25
	Black Delco-Remy I.D. Tag for Distributors, 6 Volt Starters, & 6 Volt Generators with Rivets, 3/4" 2 5/16"	

ALTERNATORS

B6001-001	12 Volt Alternator (1 Wire)	\$112.75	
63 Amp, Low Cut In, Specially Built For Tractors, Forklifts, & Other Low Engine Speed Applications			
B6001-002	12 Volt Alternator (1 Wire/3 Wire)	\$118.75	
63 Amp, With 1 Wire Or 3 Wire For Warning Lamp On Automobiles & Trucks			
B6001-006	6 Volt Alternator (1 Wire, Negative Ground)	\$166.50	
6 Volt, 40 Amp Alternator with Negative Ground, 1 Wire			

CHEVROLET TRUCK

TABLE OF CONTENTS

Spark Plug Wire Sets _____	429
Wire Harnesses _____	429
Tune Up Parts _____	430
Electronic Ignition Conversion Kits _____	431
Switches _____	432
Flashers _____	432
Cutout Relays & Voltage Regulators _____	432
Starter Bushing & Brush Sets _____	433
Starter Switches _____	433
Identification Tags _____	433
Alternators _____	433

SPARK PLUG WIRE SETS

Our Spark Plug Wire Sets Come Fully Assembled with the Proper Type Wire & Terminals.

They are Custom Tailored to Look & Fit Like Original Factory Equipment.

Varieties include:

Cotton Braid Wire: Copper Core with a Cotton Jacket.

PVC Wire: Copper Core with a Rubber Jacket.

Packard 440 Wire (P): Tinned Copper Core with EPDM Silicone Insulation and a Rubber Jacket.

Suppression Wire (S): for Electronic Ignition and is Spiral Wound, Low-Ohm, with EPDM Silicone Insulation and a Rubber Jacket.

Cotton Braid Suppression Wire (CS): also for Electronic Ignition, as Suppression Wire, but has an additional layer of Cotton Braid & Lacquer to replicate the vintage look, as well.



Chevrolet Truck 1955-1975

Inline 6 Cyl. Tailored Spark Plug Wire Set

B1058-003	Original Type Packard 440 Wire	\$157.00
B1058-003S	Suppression Wire	\$60.25



WIRING HARNESSES

Our Wire Harnesses are made with our premium cotton braid and/or PVC wire.

They have the correct gauge, color, wire, & fuse holders (if needed).

They are made with the correct gauge, color, wire, & fuse holders (if needed).

All terminals are soldered according to the original.

(Harnesses do not include Battery Cables & Spark Plug Wires; however, we can supply these as separate products.)

NO HIDDEN COSTS, NOTHING EXTRA TO BUY!

Chevrolet Truck 1934-1939

B3058-001	Complete Wire Harness	\$736.50
B3058-006	Complete Wire Harness Modified for Turn Signals & 1-Wire Alternator	\$864.25

Chevrolet Truck 1940-1946

B3058-002	Complete Wire Harness Modified for Turn Signals	\$868.25
------------------	---	-----------------

Chevrolet Truck 1947-1949

B3058-003	Complete Wire Harness Modified for Turn Signals	\$1,000.25
------------------	---	-------------------

Chevrolet Truck 1950-1952

B3058-004	Complete Wire Harness Modified for Turn Signals	\$1,000.25
B3058-005	Complete Wire Harness Modified for Turn Signals & 10SI Alternator	\$1,000.25

Note

When ordering, please specify Year or Serial Number, Magneto/Distributor, & Regulator/Cut Out Relay.

Some Harnesses were originally made with PVC Wire & Braided; others were made with PVC Wire & Taped.

In those cases, we build them the **Original Way**.

Chevrolet Truck 1929-1940

6 Cyl. Tailored Spark Plug Wire Set

B1058-001	Original Type Cotton Braid Wire	\$50.75
B1058-001P	Packard 440 Wire	\$144.50
B1058-001S	Suppression Wire	\$55.50
B1058-001CS	Cotton Suppression Wire	\$87.50

Chevrolet Truck 1941-1954

6 Cyl. Tailored Spark Plug Wire Set

B1058-002	Original Type Cotton Braid Wire	\$50.75
B1058-002P	Packard 440 Wire	\$144.50
B1058-002S	Suppression Wire	\$55.50
B1058-002CS	Cotton Suppression Wire	\$87.50

TUNE UP PARTS

Chevrolet Truck 4 Cylinder 1927-1928		
	B4001-021 Points Replaces: #1855520, D-109	\$13.75
	B4002-001 Condenser Replaces: #1928111, D-203, 1869704, D-200	\$4.75
	B4004-021 Rotor Replaces: #816774	\$14.75
	B4003-033 Cap Replaces: #811589, 1835536, 821589, 818425	\$25.50

*For 6--Volt Ignition Coils & Accessories, see p.44

Chevrolet Truck 6 Cylinder 1929-1932 (Single Point with Delco #633J Distributor)		
	B4001-021 Points Replaces: #1855520, D-109	\$13.75
	B4002-001 Condenser Replaces: #1928111, D-203, 1869704, D-200	\$4.75
	B4004-021 Rotor Replaces: #816774	\$14.75
	B4003-059 Cap Replaces: #816779, 822465, 1831800, 1853240	\$22.50

*For 6-Volt Ignition Coils & Accessories, see p.44





Chevrolet Truck 6 Cylinder 1929-1940, 1941-1948 (with Delco Distributor #1112353)		
	B4100-001 PCR Kit Includes: Points (#B4001-001), Condenser (#B4002-001), Rotor (#B4004-002) Replaces: Points - #D100HP, 1855720 Condenser - #1928111, D-203, 1869704, D-200 Rotor - #820445, D400	\$10.50
	B4004-002 Rotor Replaces: #820445, D400	\$5.75
	B4003-002 Distributor Cap Premium Grade, Made in the USA (Brass Contacts) Replaces: #824735, D301	\$20.25
	B4007-001 Cap Clip Short Mount, 1 Used Replaces: #1889967, 1847289, 453844, 453461	\$11.95
	B4007-002 Cap Clip Long Mount, 1 Used Replaces: #1889967, 1889999, 453844, 453461	\$11.95
	B4008-001 Distributor Insulator Replaces: #1904376	\$14.99
	B4009-001 Distributor Bushing & Shim Kit	\$25.99
B4006-001	Dust Cover Replaces: #1900119	\$9.99

*For 6-or 12-Volt Ignition Coils & Accessories, see p.44

Chevrolet Truck 6 Cylinder 1941-1948 with Distributor #1112353, 1112362, 1110090, & Others		
	B4001-006 Points Replaces: #1882022	\$11.75
	B4002-001 Condenser Replaces: #1928111, D-203, 1869704, D-200	\$4.75

	B4004-002 Rotor Replaces: #820445, D400	\$5.75
	B4003-002 Distributor Cap Premium Grade, Made in the USA (Brass Contacts) Replaces: #824735, D301	\$20.25
	B4007-001 Cap Clip Short Mount, 1 Used Replaces: #1889967, 1847289, 453844, 453461	\$11.95
	B4007-002 Cap Clip Long Mount, 1 Used Replaces: #1889967, 1889999, 453844, 453461	\$11.95
	B4008-001 Distributor Insulator Replaces: #1904376	\$14.99
	B4009-001 Distributor Bushing & Shim Kit	\$25.99
B4006-001	Dust Cover Replaces: #1900119	\$9.99

*For 6-or 12-Volt Ignition Coils & Accessories, see p.44

Chevrolet Truck 6 Cylinder 1949-1962 with Distributor #1112396 & Others		
	B4001-001 Points Replaces: #D100HP, 1855720	\$4.75
	B4002-001 Condenser Replaces: #1928111, D-203, 1869704, D-200	\$4.75
	B4003-034 Cap Replaces: #268574C92	\$18.25
	B4004-022 Rotor Replaces: #1924245, D-405	\$6.50

Chevrolet Truck 6 Cylinder 1963-1974		
	B4100-003 PCR Kit Includes: Points (#B4001-012), Condenser (#B4002-012), Rotor (#B4004-013) Replaces: Points - #D108P Condenser - #D205 Rotor - #D-419R, 1963972	\$9.75
	B4004-013 Rotor Premium Grade, Made in the USA Replaces: #D-419R, 1963972	\$4.75
	B4003-021 Distributor Cap Replaces: #1954569, D-316	\$8.75
B4006-004	Dust Cover Replaces: #1960325	\$16.99

Chevrolet Truck 8 Cylinder 1957-1974		
	B4001-019 Points Replaces: #D-106PS	\$6.75
	B4002-016 Condenser Replaces: #1932004, D-204	\$4.75
	B4003-032 Cap Premium Quality, Brass Contacts Replaces: #1942654, D309	\$14.25
	B4004-020 Rotor Replaces: #1852722, 1932015, D-426R	\$4.50

ELECTRONIC IGNITION CONVERSION KITS

Replaces Points & Condenser



Chevrolet Truck 6 Cyl. 1930-1935 with Delco #622S, 622Y, 639U Distributors		
B9600-309	12 Volt Negative Ground	\$154.95
B9600-309N6	6 Volt Negative Ground	\$169.45

Chevrolet Truck 6 Cyl. 1929 -1963 Also 1941-1948 with Distributor #1112353		
B9600-255LS	12 Volt Negative Ground	\$162.45
B9600-255LSN6	6 Volt Negative Ground	\$175.45



For Ignition Coils & Accessories, see p.44

SWITCHES

B5002-011	3-Position, 6-Volt Headlight Switch	\$57.75
	30 Amps, 6 Volt, 3 Position Headlight Switch. Has Four Screw Terminals. Two Stud Terminals. 5.5 Ohm Rheostat for Panel Lights & Circuit Braker. Includes Metal Knob, Shaft and Nut. Replaces: Delco - #1994016, 1994022, 1995031, 1995035, 1995041, 1995045, 1995048, D-1502, D1504 Fits: Chevrolet Truck - 1948-1950	

B5010-018	Turn Signal Light Switch	\$73.50
	Universal Turn Signal Switch. Has right turn, left turn, and warning flasher modes. Metal Construction with Color Coded Wire Leads. Fuse, clamp ring, and instruction sheet included. Fits: Pre-1953 Vehicles	

SOLENOIDS

B5007-042	6-Volt Delco Starter Solenoid Switch	\$52.75
	Replaces: Delco - #1114307, 1114310, 1114312, 1114410, 1118135, 1118140, 1118148, D936, D938, D939, D949, D964 Prestolite - #15-228, SWX-228, SWX-429 Fits: Chevrolet Truck - 6 Cyl. 1942-1954, 8 Cyl. 1942-1954	

FLASHERS

B9017-040	6-Volt Thermal Flasher	\$9.75
	6-Volt Thermal Flasher, Three Terminal Replaces: #535 Chevrolet Truck Fits: 1948-54	

CUTOUT RELAYS & VOLTAGE REGULATORS

Note: Due to modern battery design, voltage regulators can't be used to charge low or dead batteries. Doing so will destroy the voltage regulator and void the warranty.

B8001-001	6-Volt Cutout Relay	\$19.50
	15 Amps, 6 Volt Works Positive or Negative Ground Replaces: Autolite - CB4014, C4012(9-5), C4012(9-4), C4012(9-1), R40061 Delco - #266P, 266N, 265P, 265N, 5015850, 812970, 265J, 820845, 812971, 1116816, 265G, 265H, 1116755, 1116751, 1116809DR, 265B, 1842859, 265C, 1867781, 265F, 265D Fits: Chevrolet Truck - 1928 - 1939	

B8001-002	Electronic Cutout Relay	\$19.50
	25 Amp, Works with 6, 12, or 24 Volts. & Positive or Negative Ground Replaces: Autolite - #CB4014, C4012(9-5), C4012(9-4), C4012(9-1), R40061 Delco - #266P, 266N, 265P, 265N, 5015850, 812970, 265J, 820845, 812971, 1116816, 265G, 265H, 1116755, 1116751, 1116809DR, 265B, 1842859, 265C, 1867781, 265F, 265D Fits: Chevrolet Truck - 1928 - 1939	

6-Volt Saddle Mounted Cutout Relay (Delco Version)		
B8001-004	Premium Quality, Made in the USA	\$122.50
B8001-006	Standard Quality	\$38.59
	Cutout Relay, 25 Amp, 6 Volt, Works Positive or Negative Ground. Replaces: Delco - #266P, 266N, 265P, 265N, 5015850, 812970, 265J, 820845, 812971, 1116816, 265G, 265H, 1116755, 1116751, 1116809DR, 265B, 1842859, 265C, 1867781, 265F, 265D Fits: Chevrolet Truck - 1928 - 1939	

6-Volt Delco Type Voltage Regulator		
B8002-001	Premium Quality, Made in the USA	\$87.75
B8002-042	Standard Quality	\$34.75
	6-Volt, 3-Terminal, 32-42 Amps, Negative Ground, Flat Mounting Bracket, A-Circuit Replaces: Delco - 1118201, 1118300, 1118301, 1118357, 1118364, 1118721, 1118843, 1118847, 1118869, 1118872, D601, D614, D653 Fits: Chevrolet Truck - 1940-1952	

B8002-004	6-Volt Voltage Regulator	\$142.75
	6 Volt, 3 Terminal, Negative Ground, Voltage Regulator Fits: Chevrolet - 1953-1954 All Replaces Delco #1118201, 1118207, 1118211, 1118216, 1118221, 1118233, 1118237, 1118242, 1118272, 1118301, 1118311, 1118313, 1118343, 1118349, 1118361, 1118720, 1118847, 1118866, 1118869, 1118872, 1118921, 5547, 5587, 5599, 5809, 5819, 5854, 5872, 5873, 5875, 5878, D601, D614, D653 PREMIUM QUALITY/ USA MADE	

B8002-006	12-Volt Voltage Regulator	\$67.50
	12 Volt, 3 Terminal, Negative Ground, Voltage Regulator Fits: Chevrolet - 1955-1962 PREMIUM QUALITY/ USA MADE	

ALTERNATOR VOLTAGE REGULATORS

B8002-030	Alternator Voltage Regulator	\$14.50
	Heavy Duty, 12 Volt, Negative Ground Alternator Voltage Regulator. This external voltage regulator has 4 spade terminals (field, 2, 3, 4). It is designed for 'B' type circuits in negative ground systems. This is designed for use only in 12 volt systems. For Delco 10DN, & 20DN Replaces: Delco - #D630, D635, D663, 1119513, 1119515, 1119508, 1119519, D663, 1119502, 1119516, 1119506, 1119512, 1119515 Fits: Chevrolet (Truck) - 1963-1964, 1965-1969, 4,6,8 Cyl. 1970-1972	

STARTER BUSHING & BRUSH SETS

3500RK	Delco 6V Starter Repair Kit	\$11.75
	Consisting of 4 Brushes & 2 Bushings Chevrolet Truck Fits: 1953 Dump Truck (with Delco 6V, Push Button Top Starter #1107108)	

STARTER SWITCHES

B5006-004	Starter Switch	\$11.75
	6 or 12 Volt Starter Mounted Manual Push Button Starter Switch Fits: Chevrolet Truck - 1949-1954	

IDENTIFICATION TAGS

B9013-003	Large Delco Remy I.D. Tag (Blank)	\$9.00
	Large Delco Remy I.D. Tag (Stamped)	\$16.25
	Large Black Delco-Remy I.D. Tag for Distributors, 6 Volt Starters, & 6 Volt Generators with Rivets, 1 1/4" X 2 7/8"	
B9013-004	Delco Remy I.D. Tag (Blank)	\$7.00
	Delco Remy I.D. Tag (Stamped)	\$14.25
	Black Delco-Remy I.D. Tag for Distributors, 6 Volt Starters, & 6 Volt Generators with Rivets, 3/4" 2 5/16"	
B9013-005	Red Delco Remy I.D. Tag (Blank)	\$7.00
	Red Delco Remy I.D. Tag (Stamped)	\$14.25
	Red Delco-Remy I.D. Tag for 12 Volt Starters & 12 Volt Generators with Rivets, 3/4" 2 5/16"	
B9013-013	Delco Remy I.D. Tag (Blank)	\$7.00
	Delco Remy I.D. Tag (Stamped)	\$14.25
	Black Delco-Remy I.D. Tag for Distributors, 6 Volt Starters, & 6 Volt Generators with Rivets, 3/4" 2 5/16"	

ALTERNATORS

B6001-001	12 Volt Alternator (1 Wire)	\$112.75	
63 Amp, Low Cut In, Specially Built For Tractors, Forklifts, & Other Low Engine Speed Applications			
B6001-002	12 Volt Alternator (1 or 3 Wire)	\$118.75	
63 Amp, With 1 Wire Or 3 Wire For Warning Lamp On Automobiles & Trucks			
B6001-006	6 Volt Alternator (1 Wire, Negative Ground)	\$166.50	
6 Volt, 40 Amp Alternator with Negative Ground, 1 Wire			

CHRYSLER & IMPERIAL

TABLE OF CONTENTS

Spark Plug Wire Sets	434
Battery Cables	435
Tune Up Parts	436
Starter Switches	440
Electronic Ignition Conversion Kits	440
Cutout Relays & Voltage Regulators	441
Alternators	441
Switches	442
Flashers	442
Identification Tags	442
Carburetor Rebuild Kits	442

SPARK PLUG WIRE SETS

Our Spark Plug Wire Sets Come Fully Assembled with the Proper Type Wire & Terminals.

They are Custom Tailored to Look & Fit Like Original Factory Equipment.

Varieties include:

Cotton Braid Wire: Copper Core with a Cotton Jacket.

PVC Wire: Copper Core with a Rubber Jacket.

EPDM Wire (E): Hi Performance Premium Conductor with a Tinned Copper Core, EPDM Silicone Insulation, and a Rubber Jacket.

Suppression Wire (S): for Electronic Ignition and is Spiral Wound, Low-Ohm, with EPDM Silicone Insulation and a Rubber Jacket.

Cotton Braid Suppression Wire (CS): also for Electronic Ignition, as Suppression Wire, but has an additional layer of Cotton Braid & Lacquer to replicate the vintage look, as well.



Chrysler 1924

6 Cyl. Tailored Spark Plug Wire Set

B1059-001	Original Type Cotton Braid Wire	\$63.00
B1059-001E	EPDM Wire	\$68.75

Chrysler 1927 Model 50 (4-Cylinder)

4 Cyl. Tailored Spark Plug Wire Set

B1059-006	Original Type Cotton Braid Wire	\$63.00
B1059-006E	EPDM Wire	\$68.75
B1059-006S	Suppression Wire	\$68.75
B1059-006CS	Cotton Suppression Wire	\$109.00

Chrysler 1927 Model 80 (6-Cylinder)

6 Cyl. Tailored Spark Plug Wire Set

B1059-008	Original Type Cotton Braid Wire	\$60.00
B1059-008E	EPDM Wire	\$65.50

Chrysler 1931-1950 (8-Cylinder Flathead)

CG, CH, CL, CV/CX, CW, C1, C2, C3, C9, C10, C11, C15, C17, C19, C20, C23, C24, C26, C27, C30, C33, C36, C37, New Yorker, Saratoga

8 Cyl. Tailored Spark Plug Wire Set

B1059-011	Original Type Cotton Braid Wire	\$65.75
B1059-011E	EPDM Wire	\$72.00
B1059-011S	Suppression Wire	\$72.00
B1059-011CS	Cotton Suppression Wire	\$115.00

Chrysler 1934-1935 CU, CV, CZ, C1, C2, C3 & 1937-1938 C8, C9, C10, C11, C17

8 Cyl. Tailored Spark Plug Wire Set

B1059-009	Original Type Cotton Braid Wire	\$68.00
B1059-009E	EPDM Wire	\$74.00

Chrysler 1939-1947

6 Cyl. Tailored Spark Plug Wire Set

B1059-002	Original Type Cotton Braid Wire	\$53.75
B1059-002E	EPDM Wire	\$58.75
B1059-002S	Suppression Wire	\$58.75
B1059-002CS	Cotton Suppression Wire	\$92.75

Chrysler 1948-1954 (6-Cylinder)

6 Cyl. Tailored Spark Plug Wire Set

B1059-010	Original Type Cotton Braid Wire	\$50.75
B1059-010E	EPDM Wire	\$55.50
B1059-010S	Suppression Wire	\$55.50
B1059-010CS	Cotton Suppression Wire	\$87.50

Chrysler 1951-1954 (8-Cylinder)

8 Cyl. Tailored Spark Plug Wire Set

B1059-003	Original Type Cotton Braid Wire	\$68.00
B1059-003E	EPDM Wire	\$74.50

Chrysler 1955 C67 (6-Cylinder)

6 Cyl. Tailored Spark Plug Wire Set

B1059-005	Original Type PVC Wire	\$61.75
B1059-005E	EPDM Wire	\$67.25

Chrysler 1955 C68, C69, C70 (8-Cylinder)

8 Cyl. Tailored Spark Plug Wire Set

B1059-004	Original Type Cotton Braid Wire	\$68.00
B1059-004E	EPDM Wire	\$74.00

Chrysler 1959-1961 V8 with Ram Air & **Chrysler 1965-1972 V8**

with 383cid, 400cid, 413cid, 430cid Engines

8 Cyl. Tailored Spark Plug Wire Set

B1059-007	Original Type EPDM Wire	\$67.50
B1059-007S	Suppression Wire	\$67.50

BATTERY CABLES



Our Battery Cables are made from the Proper Gauge Copper, as either Black Cotton Braided Wire or PVC Wire (whichever is correct for the application), using Soldered & Heat Sealed Brass or Copper Terminals.

Chrysler 1929

B2059-057	Negative Battery Cable (with Armor)	\$66.75
------------------	-------------------------------------	----------------

Chrysler 8 Cyl. 1930-1931

B2059-001	Negative Battery Cable	\$36.00
------------------	------------------------	----------------

Chrysler 6 Cyl. 1940 C25

B2059-002	Positive Battery Cable	\$73.00
B2059-003	Negative Battery Cable	\$41.50

Chrysler 8 Cyl. 1940 C26

B2059-004	Positive Battery Cable	\$73.00
B2059-005	Negative Battery Cable	\$41.50

Chrysler 8 Cyl. 1940 C27

B2059-006	Positive Battery Cable	\$80.50
B2059-007	Negative Battery Cable	\$41.50

Chrysler 6 Cyl. 1941 C28

B2059-008	Positive Battery Cable	\$47.75
B2059-009	Negative Battery Cable	\$41.50

Chrysler 8 Cyl. 1941

B2059-010	Positive Battery Cable	\$47.75
B2059-011	Negative Battery Cable	\$41.50

Chrysler 6 Cyl. 1942 C34

B2059-012	Positive Battery Cable	\$44.00
B2059-013	Negative Battery Cable	\$41.50

Chrysler 8 Cyl. 1942 C36

B2059-014	Positive Battery Cable	\$44.00
B2059-015	Negative Battery Cable	\$44.00

Chrysler 6 Cyl. 1946-1948

B2059-016	Positive Battery Cable	\$44.00
B2059-017	Negative Battery Cable	\$41.50

Chrysler 8 Cyl. 1946-1948

B2059-018	Positive Battery Cable	\$44.00
B2059-019	Negative Battery Cable	\$44.00

Chrysler 6 Cyl. 1949-1950

B2059-020	Positive Battery Cable	\$44.00
B2059-021	Negative Battery Cable	\$34.00

Chrysler 8 Cyl. 1949-1950

B2059-022	Positive Battery Cable	\$47.75
B2059-023	Negative Battery Cable	\$34.00

Chrysler 6 Cyl. 1951

B2059-024	Positive Battery Cable	\$23.75
B2059-025	Negative Battery Cable	\$34.00
B2059-026	Switch to Starter Cable	\$48.00

Chrysler 8 Cyl. 1951

B2059-027	Positive Battery Cable	\$23.75
B2059-028	Negative Battery Cable	\$34.00
B2059-029	Switch to Starter Cable	\$48.00

Chrysler 6 Cyl. 1952-1953

B2059-030	Positive Battery Cable	\$23.75
B2059-031	Negative Battery Cable	\$34.00
B2059-032	Switch to Starter Cable	\$48.00

Chrysler 6 Cyl. 1954

B2059-033	Positive Battery Cable	\$23.00
B2059-034	Negative Battery Cable	\$37.00
B2059-035	Switch to Starter Cable	\$41.50

Chrysler 1952 V8

B2059-036	Positive Battery Cable	\$23.75
B2059-037	Negative Battery Cable	\$34.00
B2059-038	Switch to Starter Cable	\$48.00

Chrysler 1953 V8

B2059-039	Positive Battery Cable	\$23.75
B2059-040	Negative Battery Cable	\$34.00
B2059-041	Switch to Starter Cable	\$48.00

Chrysler 1954 V8

B2059-042	Positive Battery Cable	\$23.00
B2059-043	Negative Battery Cable	\$37.00
B2059-044	Switch to Starter Cable	\$60.25

Chrysler 8 Cyl. 1955 C67

B2059-045	Positive Battery Cable	\$31.25
B2059-046	Negative Battery Cable	\$37.00
B2059-047	Switch to Starter Cable	\$41.50

Chrysler 8 Cyl. 1955 C68

B2059-048	Positive Battery Cable	\$31.25
B2059-049	Negative Battery Cable	\$37.00
B2059-050	Switch to Starter Cable	\$41.50

Chrysler 8 Cyl. 1955 C69

B2059-051	Positive Battery Cable	\$31.25
B2059-052	Negative Battery Cable	\$37.00
B2059-053	Switch to Starter Cable	\$41.50

Chrysler 8 Cyl. 1955 C70

B2059-054	Positive Battery Cable	\$31.25
B2059-055	Negative Battery Cable	\$37.00
B2059-056	Switch to Starter Cable	\$41.50

TUNE UP PARTS

Chrysler 4 Cylinder 1927		
	B4001-021	\$13.75
	Points Replaces: #1855520, D-109	
	B4002-001	\$4.75
	Condenser Replaces: #1928111, D-203, 1869704, D-200	
	B4004-021	\$14.75
	Rotor Replaces: #816774	
	B4003-033	\$25.50
	Cap Replaces: #811589, 1835536, 821589, 818425	

*For 6-Volt Ignition Coils & Accessories, see p.44

Chrysler 4 Cylinder 1982-1985 w/ 2.2 Ltr.		
	B4003-072	\$16.00
	Cap Replaces: #5206918, 5213034	

Chrysler 6 Cylinder 1926-1932 (Single Point with Delco #631B, 637J, 637N, 639X Distributor)		
	B4001-021	\$13.75
	Points Replaces: #1855520, D-109	
	B4002-001	\$4.75
	Condenser Replaces: #1928111, D-203, 1869704, D-200	
	B4004-021	\$14.75
	Rotor Replaces: #816774	
	B4003-059	\$22.50
	Cap Replaces: #816779, 822465, 1831800, 1853240	

*For 6-Volt Ignition Coils & Accessories, see p.44

Chrysler 6 Cylinder 1928-1932 (Dual Points) with Delco Distributor #659E		
	B4001-007	\$49.75
	Points Dual Point set Consists of 1 set each, left & right hand Replaces: #1882022	
	B4002-001	\$4.75
	Condenser Replaces: #1928111, D-203, 1869704, D-200	
	B4003-002	\$20.25
	Distributor Cap Premium Grade, Made in the USA (Brass Contacts) Replaces: #824735, D301	
	B4004-002	\$5.75
	Rotor Replaces: #820445, D400	
	B4007-001	\$11.95
	Cap Clip Short Mount, 1 Used Replaces: #1889967, 1847289, 453844, 453461	
	B4007-002	\$11.95
	Cap Clip Long Mount, 1 Used Replaces: #1889967, 1889999, 453844, 453461	
	B4009-001	\$25.99
	Distributor Bushing & Shim Kit	
B4006-001	Dust Cover	Replaces: #1900119 \$9.99

*For 6-Volt Ignition Coils & Accessories, see p.44

Chrysler 6 Cylinder 1933-1934 with Delco Distributor #644W & others (Except Delco Distributor #622C)		
	B4100-001	\$10.50
	PCR Kit Includes: Points (#B4001-001), Condenser (#B4002-001), Rotor (#B4004-002) Replaces: Points - #D100HP, 1855720 Condenser - #1928111, D-203, 1869704, D-200 Rotor - #820445, D400	
	B4004-002	\$5.75
	Rotor Replaces: #820445, D400	

	B4003-002	\$20.25
Distributor Cap Premium Grade, Made in the USA (Brass Contacts) Replaces: #824735, D301		
	B4007-001	\$11.95
Cap Clip Short Mount, 1 Used Replaces: #1889967, 1847289, 453844, 453461		
	B4007-002	\$11.95
Cap Clip Long Mount, 1 Used Replaces: #1889967, 1889999, 453844, 453461		
	B4008-001	\$14.99
Distributor Insulator Replaces: #1904376		
	B4009-001	\$25.99
Distributor Bushing & Shim Kit		
B4006-001	Dust Cover	Replaces: #1900119 \$9.99

*For 6- or 12-Volt Ignition Coils & Accessories, see p.44

Chrysler 6 Cylinder 1935-1938

	B4001-002	\$14.75
Points Replaces: #IGW-3028S, 1-31		
	B4002-006	\$7.50
Condenser Replaces: #2-31, 2-38, 2-42, 2-95, IAT-1125S, IAT-3076BS, IBB-2042SS-1, IBB-2042-SS3, IG-3927F, IG-3927G, IG-3927K, IG-3927R		
	B4004-007	\$8.25
Rotor Premium Grade, Made in the USA Replaces: #4-19		
	B4003-007	\$25.00
Distributor Cap Premium Grade, Made in the USA (Brass Contacts) Replaces: #IGC-1107S, 3-23		

*For 6- Volt Ignition Coils & Accessories, see p.44

Chrysler 6 Cylinder 1939-1948

	B4001-005	\$9.75
Points Replaces: #1-4, 1-8, 1-9, 1-20, 1-22, 1-45, IAD-3128S, IGP-3028ES, IGP3028FS, IGS2224L, IGW3028AS		

	B4002-006	\$7.50
Condenser Replaces: #2-31, 2-38, 2-42, 2-95, IAT-1125S, IAT-3076BS, IBB-2042SS-1, IBB-2042-SS3, IG-3927F, IG-3927G, IG-3927K, IG-3927R		
	B4004-007	\$8.25
Rotor Premium Grade, Made in the USA Replaces: #4-19		
	B4003-007	\$25.00
Distributor Cap Premium Grade, Made in the USA (Brass Contacts) Replaces: #IGC-1107S, 3-23		



*For 6-Volt Ignition Coils & Accessories, see p.44



Chrysler 6 Cylinder 1949-Early 1950



	B4001-005	\$9.75
Points Replaces: #1-4, 1-8, 1-9, 1-20, 1-22, 1-45, IAD-3128S, IGP-3028ES, IGP3028FS, IGS2224L, IGW3028AS		
B4002-002	\$4.75	
	Condenser Replaces: #2-23, 2-31, 2-32, 2-34, 2-38, 2-42, IAT-2015L, IAT-2015R, IAT-3076AS, IAT-3076BS, IAT-3076D, IAT-3076DS, IAT-3076L, IAT-3076LA, IAT-3076R, IAT-3076RA, IBB-2015L, IBB-2015R, IBB-2042-SS, IBB-2042SS-1, IBB-2042-SS3, IG-2671F, IGH-3076, IGW-3139, 2098058, 3420600	
	B4003-035	\$31.50
Cap Replaces: #IAO-1003, 3-1		
	B4004-007	\$8.25
Rotor Premium Grade, Made in the USA Replaces: #4-19		

*For 6-Volt Ignition Coils & Accessories, see p.44

Chrysler 6 Cylinder Late 1950

	B4001-022	\$16.75
Points Replaces: #IGS-2224, 1-44, 2084075		
B4002-002	\$4.75	
	Condenser Replaces: #2-23, 2-31, 2-32, 2-34, 2-38, 2-42, IAT-2015L, IAT-2015R, IAT-3076AS, IAT-3076BS, IAT-3076D, IAT-3076DS, IAT-3076L, IAT-3076LA, IAT-3076R, IAT-3076RA, IBB-2015L, IBB-2015R, IBB-2042-SS, IBB-2042SS-1, IBB-2042-SS3, IG-2671F, IGH-3076, IGW-3139, 2098058, 3420600	

	B4003-054	\$17.75
	Cap Replaces: #IAT-1003, 3-3	
	B4004-025	\$6.75
	Rotor Replaces: #IAT-1016	

	B4003-036	\$13.50
	Cap Replaces: #IAT-1033, IAT-1033A, IAT-1033C, 3-4, 3-34, 3-37	
	B4004-026	\$6.75
	Rotor Replaces: #IAU-1016A, 4-4	

*For 6-Volt Ignition Coils & Accessories, see p.44

Chrysler 6 Cylinder 1951-1952

	B4001-022	\$16.75
	Points Replaces: #IGS-2224, 1-44, 2084075	

B4002-002	\$4.75
------------------	---------------

	Condenser Replaces: #2-23, 2-31, 2-32, 2-34, 2-38, 2-42, IAT-2015L, IAT-2015R, IAT-3076AS, IAT-3076BS, IAT-3076D, IAT-3076DS, IAT-3076L, IAT-3076LA, IAT-3076R, IAT-3076RA, IBB-2015L, IBB-2015R, IBB-2042-SS, IBB-2042SS-1, IBB-2042-SS3, IG-2671F, IGH-3076, IGW-3139, 2098058, 3420600	
---	---	--

	B4003-036	\$13.50
	Cap Replaces: #IAT-1033, IAT-1033A, IAT-1033C, 3-4, 3-34, 3-37	

	B4004-025	\$6.75
	Rotor Replaces: #IAT-1016	

*For 6-Volt Ignition Coils & Accessories, see p.44

Chrysler 6 Cylinder 1953-1954

	B4001-022	\$16.75
	Points Replaces: #IGS-2224, 1-44, 2084075	

B4002-002	\$4.75
------------------	---------------

	Condenser Replaces: #2-23, 2-31, 2-32, 2-34, 2-38, 2-42, IAT-2015L, IAT-2015R, IAT-3076AS, IAT-3076BS, IAT-3076D, IAT-3076DS, IAT-3076L, IAT-3076LA, IAT-3076R, IAT-3076RA, IBB-2015L, IBB-2015R, IBB-2042-SS, IBB-2042SS-1, IBB-2042-SS3, IG-2671F, IGH-3076, IGW-3139, 2098058, 3420600	
---	---	--

Chrysler 6-Cylinder 1980-1983, 225, 3.7L Eng.

	B4003-071	\$10.50
	Cap Replaces: #4176030	

	B4004-029	\$5.75
	Rotor Replaces: #4-1C, 4-16, 297981, 1394885, 1838516, 2098770, 2716867, 3874401, 4106104, 12309507, 312769607, C401, C401Z, C403, C411, CH308, CH310, CH312, CH317, CH403, DRC303, DRC329, XA921	

Chrysler 8 Cylinder 1929-1934 (Most Models)

	B4001-006	\$11.75
	Points Replaces: #1882022	

	B4002-001	\$4.75
	Condenser Replaces: #1928111, D-203, 1869704, D-200	

	B4003-028	\$26.25
	Cap Top Quality USA Made With Brass Contacts Replaces: #1911556, D-302	

	B4004-018	\$5.75
	Rotor Replaces: #1836893	

	B4007-001	\$11.95
	Cap Clip Short Mount, 1 Used Replaces: #1889967, 1847289, 453844, 453461	

	B4007-002	\$11.95
	Cap Clip Long Mount, 1 Used Replaces: #1889967, 1889999, 453844, 453461	

	B4009-001	\$25.99
	Distributor Bushing & Shim Kit	

*For 6-Volt Ignition Coils & Accessories, see p.44

Chrysler 8 Cylinder 1935-1938
(All Except C2 Imperial)

	B4001-002	\$14.75
	Points Replaces: #IGW-3028S, 1-31	

	B4002-005	\$9.75
	Condenser Replaces: #2-24, 2-35, 2-22, 2-23	

	B4003-037	\$36.50
	Cap Replaces: #IGP-1003, 3-26	

	B4004-027	\$7.75
	Rotor Replaces: #4-17	

*For 6-Volt Ignition Coils & Accessories, see p.44

Chrysler 8 Cylinder 1939-1950

B4002-002	\$4.75
Condenser Replaces: #2-23, 2-31, 2-32, 2-34, 2-38, 2-42, IAT-2015L, IAT-2015R, IAT-3076AS, IAT-3076BS, IAT-3076D, IAT-3076DS, IAT-3076L, IAT-3076LA, IAT-3076R, IAT-3076RA, IBB-2015L, IBB-2015R, IBB-2042-SS, IBB-2042SS-1, IBB-2042-SS3, IG-2671F, IGH-3076, IGW-3139, 2098058, 3420600	

	B4004-027	\$7.75
	Rotor Replaces: #4-17	

*For 6-Volt Ignition Coils & Accessories, see p.44

Chrysler 1951-1955 (Dual Points)

	B4001-023	\$19.75
	Points *2 Required- Each Sold Separately* Replaces: #IAZ-2040RS, 1-19, 1-26, 1-41, IAZ-2040RS, IGP-3028ZS, IGW-3028KS	

B4002-002	\$4.75
Condenser Replaces: #2-23, 2-31, 2-32, 2-34, 2-38, 2-42, IAT-2015L, IAT-2015R, IAT-3076AS, IAT-3076BS, IAT-3076D, IAT-3076DS, IAT-3076L, IAT-3076LA, IAT-3076R, IAT-3076RA, IBB-2015L, IBB-2015R, IBB-2042-SS, IBB-2042SS-1, IBB-2042-SS3, IG-2671F, IGH-3076, IGW-3139, 2098058, 3420600	

	B4003-038	\$31.75
	Cap Replaces: #IAR-1003, 3-2	

	B4004-027	\$7.75
	Rotor Replaces: #4-17	

*For 12-Volt Ignition Coils & Accessories, see p.44

Chrysler 8 Cylinder 1956-1958 (Dual Points)

	B4001-023	\$19.75
	Points *2 Required- Each Sold Separately* Replaces: #IAZ-2040RS, 1-19, 1-26, 1-41, IAZ-2040RS, IGP-3028ZS, IGW-3028KS	

B4002-002	\$4.75
Condenser Replaces: #2-23, 2-31, 2-32, 2-34, 2-38, 2-42, IAT-2015L, IAT-2015R, IAT-3076AS, IAT-3076BS, IAT-3076D, IAT-3076DS, IAT-3076L, IAT-3076LA, IAT-3076R, IAT-3076RA, IBB-2015L, IBB-2015R, IBB-2042-SS, IBB-2042SS-1, IBB-2042-SS3, IG-2671F, IGH-3076, IGW-3139, 2098058, 3420600	

	B4003-039	\$18.75
	Cap Replaces: #IBN-1003, 3-8, 3-35	

	B4004-028	\$6.25
	Rotor Replaces: #1658535, 41059, 3926326, 980892, R103003, IBK1016, 4-7	



*For 12-Volt Ignition Coils & Accessories, see p.44

Chrysler 1957-1958 (Single Points)

	B4001-008	\$4.75
	Points Replaces: #IBP-2040R, IBP-3028AS, 1-32, 1-46	

B4002-002	\$4.75
	Condenser Replaces: #2-23, 2-31, 2-32, 2-34, 2-38, 2-42, IAT-2015L, IAT-2015R, IAT-3076AS, IAT-3076BS, IAT-3076D, IAT-3076DS, IAT-3076L, IAT-3076LA, IAT-3076R, IAT-3076RA, IBB-2015L, IBB-2015R, IBB-2042-SS, IBB-2042SS-1, IBB-2042-SS3, IG-2671F, IGH-3076, IGW-3139, 2098058, 3420600
	B4003-039 \$18.75 Cap Replaces: #IBN-1003, 3-8, 3-35
	B4004-028 \$6.25 Rotor Replaces: #1658535, 41059, 3926326, 980892, R103003, IBK1016, 4-7

*For 12-Volt Ignition Coils & Accessories, see p.44

Chrysler 8 Cylinder 1959 (Windsor & Saratoga)	
	B4001-017 \$6.50 Points Replaces: #IBP-2040L, IBP-3028BS, 1-33, 1-47V, 1-48
	B4002-002 \$4.75 Condenser Replaces: #2-23, 2-31, 2-32, 2-34, 2-38, 2-42, IAT-2015L, IAT-2015R, IAT-3076AS, IAT-3076BS, IAT-3076D, IAT-3076DS, IAT-3076L, IAT-3076LA, IAT-3076R, IAT-3076RA, IBB-2015L, IBB-2015R, IBB-2042-SS, IBB-2042SS-1, IBB-2042-SS3, IG-2671F, IGH-3076, IGW-3139, 2098058, 3420600
	B4003-039 \$18.75 Cap Replaces: #IBN-1003, 3-8, 3-35
	B4004-028 \$6.25 Rotor Replaces: #1658535, 41059, 3926326, 980892, R103003, IBK1016, 4-7

STARTER SWITCHES

B5006-004	Starter Switch	\$11.75
	6 or 12 Volt Starter Mounted Manual Push Button Starter Switch Fits: Chrysler - 1929-1934	

B7003-001	Starter Brush Spring	\$2.50
	For Chrysler 1.5 & 1.8 HP Gear Reduction Starters Replaces: Chrysler- #941, 636841, 2084666, 2084666, CH-1050 Prestolite- #50-363, 50-65, MZ-19, MZ-19A, MZ-19S Fits starters: Chrysler- #2275550, 2932812, 3837328, 3855247, 3874345 Prestolite- #46-3561, MDU6103, MDU6103S	

ELECTRONIC IGNITION CONVERSION KITS

Replaces Points & Condenser



Chrysler 4 Cyl. 1926-1928 with Delco 629K Distributor		
B9600-311	12 Volt Negative Ground	\$154.95
B9600-311P6	6 Volt Positive Ground	\$165.45
Chrysler 6 Cyl. 1928-1932 All with Single Point Delco #631B, 639X Distributors		
B9600-309	12 Volt Negative Ground	\$154.95
B9600-309P6	6 Volt Positive Ground	\$169.45
Chrysler 6 Cyl. 1933-1934 All (Except Distributor #622C)		
B9600-255LS	12 Volt Negative Ground	\$162.45
B9600-255LSP12	12 Volt Positive Ground	\$175.45
B9600-255LSP6	6 Volt Positive Ground	\$175.45
Chrysler 6 Cyl. 1935-1942 & 1946-1950 All with Autolite IGS, IAP Series Distributor		
B9600-307LS	12 Volt Negative Ground	\$169.45
B9600-307LSP6	6 Volt Positive Ground	\$185.95
Chrysler 6 Cyl. 1950 with Autolite IAT-4101 (Chrysler IND 33) Distributor		
B9600-041	12 Volt Negative Ground	\$191.45
Chrysler 8 Cyl. 1960-1975 All with Single Point Distributor		
B9600-042A	12 Volt Negative Ground	\$118.95
Chrysler 8 Cyl. 1959-1971 with Dual Point Distributor (Except 340 Six Pack)		
B9600-043	12 Volt Negative Ground	\$92.99
Chrysler 8 Cyl. 1968-1973 340 Six Pack		
B9600-044	12 Volt Negative Ground	\$139.95



For Ignition Coils & Accessories, see p.44

CUTOUT RELAYS & VOLTAGE REGULATORS

Note: Due to modern battery design, voltage regulators can't be used to charge low or dead batteries. Doing so will destroy the voltage regulator and void the warranty.

B8001-001	6-Volt Cutout Relay	\$19.50
------------------	----------------------------	----------------

	15 Amps, 6 Volt Works Positive or Negative Ground Replaces: Autolite - CB4014, C4012(9-5), C4012(9-4), C4012(9-1), R40061 Delco - #266P, 266N, 265P, 265N, 5015850, 812970, 265J, 820845, 812971, 1116816, 265G, 265H, 1116755, 1116751, 1116809DR, 265B, 1842859, 265C, 1867781, 265F, 265D Fits: Chrysler - (Most Models) 1928-1934
--	---

B8001-002	Electronic Cutout Relay	\$19.50
------------------	--------------------------------	----------------

	25 Amp, Works with 6, 12, or 24 Volts. & Positive or Negative Ground Replaces: Autolite - #CB4014, C4012(9-5), C4012(9-4), C4012(9-1), R40061 Delco - #266P, 266N, 265P, 265N, 5015850, 812970, 265J, 820845, 812971, 1116816, 265G, 265H, 1116755, 1116751, 1116809DR, 265B, 1842859, 265C, 1867781, 265F, 265D Fits: Chrysler - (Most Models) 1928-1934
--	---

B8002-044	6-Volt Voltage Regulator	\$149.75
------------------	---------------------------------	-----------------

	Positive Ground, 37-41 Amp, USA Made Replaces: Delco - #1118202, 1118212, 1118222, 1118226, 1118232, 1118238, 1118276, 1118278, 1118302, 1118314, 1118331, 1118351, 1118360, 1118366, 1118380, 1118382, 1118387, 1118392, 1118393, 1118726, 1118730, 1118731, 1118732, 1118743, 1118828, 1118829, 1118830, 1118834, 1118841, 1118842, 1118846, 1118850, 1118864, 1118865, 1118867, 1118950, 1119272, 5847, 5852, 5871, 5877, 5885, D602, D604, D607, D608, D610, D612 Fits: Chrysler 1937-1938, 6,8 cyl (Excl. 1938, 6 cyl.)
--	--

B8002-028	6-Volt Autolite Type Voltage Regulator	\$158.60
------------------	---	-----------------

	6 Volt, 3 Terminal, Flat Mounting Bracket Regulator (Premium Quality, USA Made) Replaces: Prestolite - #8-117, 8-70, 8-74, GRX-761, VBE-6102A, VBE-6104A, VBO-4601F, VBO-4601K, VBO-4602B, VBO-4602R, VRB-4002C, VRP-4001A, VRP-4001B, VRP-4002D, VRP-4003A, VRP-4003B, VRP-4004A, VRP-4004C, VRP-4004F, VRP-4008A, VRP-6001A, VRP-6001B, VRP-6002A, VRP-6005A, VRP-6101A, VRP-6101B Chrysler - #1120515, 1121978, 1257394, 1321757, 1343573, 1571161, 2095209, 871763 Fits: Chrysler - 1939 to 1949 (All Except GEB Generator, & 1942 C-37)
--	--

B8002-031	6-Volt Autolite Type Voltage Regulator	\$144.88
------------------	---	-----------------

	6 Volt, 3 Terminal, Flat Mounting Bracket Regulator. Positive Ground. (Premium Quality Made in the USA) Replaces: Chrysler - #1311467, 1343753, 1502074, 1641510 Delco - #A602, A602M Prestolite - #8-76, 8-762, VBE-6001A, VBE-6101, VBE-6201A, VBO-4602E, VBO-4602V Fits: Chrysler - 6 Cyl. 1953-1954 (All with Windsor Engine), 6 Cyl. 1949-1952 (All with GGW Generator), 8 Cyl. 1953-1955 (All with New Yorker, Windsor Engine), 8 Cyl. 1949-1952 (All with GGW Generator)
--	---

B8002-008	12-Volt Autolite Type Voltage Regulator	\$69.75
------------------	--	----------------

	12 Volt, 3 Terminal, Flat Mounting (Premium Quality, USA Made) Replaces: Prestolite - 8-154, 8-414, 8-58, 8-59, 8-722, 8-85, GRX-722, VBO-4201E, VBO-4202A, VBO-4202B, VBO-4202P, VBO-4202R, VR-6301A, VRX-6010, VRX-6010A Chrysler - 1642333, 1842798, 1889944, 2095341, 2095531 Delco - 1972029, 1972061, A600, A600M, A605, A605M Fits: Chrysler - 1953-1960 (Except GGA Generator)
--	--

B8002-047	12-Volt Delco Chrysler Voltage Regulator	\$18.00
------------------	---	----------------

	Negative Polarity, A-Circuit, Not adjustable, Includes Tolerance Ring, Indicator Lamp Drive Chrysler Replaces -- #3656217, 4091727, 4240443
--	--



ALTERNATORS

Delco 10SI Type

B6001-001	12 Volt Alternator (1 Wire)	\$112.75
------------------	------------------------------------	-----------------

63 Amp, Low Cut In, Specially Built For Tractors, Forklifts, & Other Low Engine Speed Applications

B6001-002	12 Volt Alternator (1 Wire/ 3 Wire)	\$118.75
------------------	--	-----------------

63 Amp, With 1 Wire Or 3 Wire For Warning Lamp On Automobiles & Trucks

B6001-005	6 Volt Alternator (1 Wire, Positive Ground)	\$166.50
------------------	--	-----------------

6 Volt, 40 Amp Alternator with Positive Ground, 1 Wire, 3/8" pulley



SWITCHES

B5010-018	Turn Signal Light Switch	\$73.50
		Universal Turn Signal Switch. Has right turn, left turn, and warning flasher modes. Metal Construction with Color Coded Wire Leads. Fuse, clamp ring, and instruction sheet included. Fits: Pre-1953 Vehicles

FLASHERS

B9017-040	6-Volt Thermal Flasher	\$9.75
		6-Volt Thermal Flasher, Three Terminal Replaces: #535 Chrysler Fits: 1941-55

IDENTIFICATION TAGS



B9013-001	Small Autolite I.D. Tag (Blank)	\$7.00
	Small Autolite I.D. Tag (Stamped)	\$14.25
		2 5/16" Long, Black I.D. Tag for Distributors, Starters, & Generators with Rivets
B9013-002	Large Autolite I.D. Tag (Blank)	\$7.00
	Large Autolite I.D. Tag (Stamped)	\$14.25
		2 15/16" Long, Black I.D. Tag for Distributors, Starters, & Generators with Rivets

Delco Remy

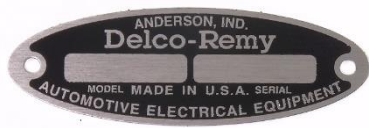
B9013-003	Large Delco Remy I.D. Tag (Blank)	\$9.00
	Large Delco Remy I.D. Tag (Stamped)	\$16.25
		Large Black Delco-Remy I.D. Tag for Distributors, 6 Volt Starters, & 6 Volt Generators with Rivets, 1 1/4" X 2 7/8"

B9013-004	Delco Remy I.D. Tag (Blank)	\$7.00
	Delco Remy I.D. Tag (Stamped)	\$14.25
		Black Delco-Remy I.D. Tag for Distributors, 6 Volt Starters, & 6 Volt Generators with Rivets, 3/4" 2 5/16"
B9013-013	Delco Remy I.D. Tag (Blank)	\$7.00
	Delco Remy I.D. Tag (Stamped)	\$14.25
		Black Delco-Remy I.D. Tag for Distributors, 6 Volt Starters, & 6 Volt Generators with Rivets, 3/4" 2 5/16"

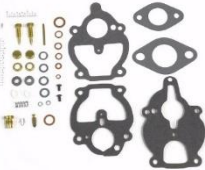
CARBURETOR REBUILD KITS

B9022-019	Carter Carburetor Rebuild Kit	\$39.75
		Chrysler Engine Model 230", 251", 265" Fits Carburetor: Carter Carburetor: #E7R1
B9022-008	Zenith Carburetor Rebuild Kit	\$26.95
		Chrysler Engine Model 32, T112, T125, 1.6 Liter Fits Carburetor: Zenith Carburetor: #9698, 13004, 13851, 14544 Chrysler Carburetor: #4142128
B9022-009	Zenith Carburetor Rebuild Kit	\$27.99
		Chrysler Engine Model 32, T78, 218", 318" Fits Carburetor: Zenith Carburetor: #10608, 10608A, 10608B, 10608C, 10888, 11483, 11885, 11885A, 11885B, 11622, 11644, S496, S496A Chrysler Carburetor: #995200, 1140252, 1316376, 1533324, 1551519
B9022-011	Zenith Carburetor Rebuild Kit	\$24.99
		Chrysler Engine Model 30 Fits Carburetor: Zenith Carburetor: #12730, 12731, 14992 Chrysler Carburetor: #2125827, 21258856

CLEVELAND

SPARK PLUG WIRE SETS

Our Spark Plug Wire Sets Come Fully Assembled with the Proper Type Wire & Terminals.

They are Custom Tailored to Look & Fit Like Original Factory Equipment.

Varieties include:

Cotton Braid Wire: Copper Core with a Cotton Jacket.

PVC Wire: Copper Core with a Rubber Jacket.

EPDM Wire (E): Hi Performance Premium Conductor with a Tinned Copper Core, EPDM Silicone Insulation, and a Rubber Jacket.

Suppression Wire (S): for Electronic Ignition and is Spiral Wound, Low-Ohm, with EPDM Silicone Insulation and a Rubber Jacket.

Cotton Braid Suppression Wire (CS): also for Electronic Ignition, as Suppression Wire, but has an additional layer of Cotton Braid & Lacquer to replicate the vintage look, as well.



Cleveland 1926

6 Cyl. Tailored Spark Plug Wire Set

B1060-001	Original Type Cotton Braid Wire	\$51.00
B1060-001E	EPDM Wire	\$55.50

BATTERY CABLES



Our Battery Cables are made from the Proper Gauge Copper, as either **Black Cotton Braided Wire** or **PVC Wire** (whichever is correct for the application), using Soldered & Heat Sealed Brass or Copper Terminals.

Cleveland 1922, Model 41

B2060-004	Negative Battery Cable with <i>Original Armor</i>	\$55.50
B2060-005	Positive Battery Cable	\$26.75
B2060-006	Switch to Starter Cable	\$24.00

Cleveland 1926

B2060-001	Negative Battery Cable	\$36.50
B2060-002	Positive Battery Cable	\$28.50
B2060-003	Switch to Starter Cable	\$25.25

CORBITT TRUCK

SPARK PLUG WIRE SETS

Corbitt Truck with Continental TA427 Motor
6 Cyl. Tailored Spark Plug Wire Set

B1106-001	Original Type Cotton Braid Wire	\$51.00
B1106-001E	EPDM Wire	\$55.50
B1106-001S	Suppression Wire	\$55.50
B1106-001CS	Cotton Suppression Wire	\$87.50

TUNE UP PARTS

Corbitt Truck 6 Cylinder with Continental TA427 Motor & Delco Distributor #1111774

	B4100-001	\$10.50
	PCR Kit Includes: Points (#B4001-001), Condenser (#B4002-001), Rotor (#B4004-002) Replaces: Points - #D100HP, 1855720 Condenser - #1928111, D-203, 1869704, D-200 Rotor - #820445, D400	
	B4004-002	\$5.75
	Rotor Replaces: #820445, D400	
	B4003-002	\$20.25
	Distributor Cap Premium Grade, Made in the USA (Brass Contacts) Replaces: #824735, D301	
	B4006-001	\$9.99
	Dust Cover Replaces: #1900119	
	B4007-001	\$11.95
	Cap Clip Short Mount, 1 Used Replaces: #1889967, 1847289, 453844, 453461	
	B4007-002	\$11.95
	Cap Clip Long Mount, 1 Used Replaces: #1889967, 1889999, 453844, 453461	
	B4008-001	\$14.99
	Distributor Insulator Replaces: #1904376	
	B4009-001	\$25.99
	Distributor Bushing & Shim Kit	



ELECTRONIC IGNITION CONVERSION KITS

Replaces Points & Condenser

Corbitt Truck 6 Cyl. with Continental TA427 Motor & Delco Distributor #1111774		
B9600-255LS	12 Volt Negative Ground	\$162.45
B9600-255LSP12	12 Volt Positive Ground	\$175.45
B9600-255LSP6	6 Volt Positive Ground	\$175.45

*For Ignition Coils & Accessories, see p.44

IDENTIFICATION TAGS

B9013-004	Delco Remy I.D. Tag (Blank)	\$7.00
	(Stamped)	\$14.25
	Black Delco-Remy I.D. Tag for Distributors, 6 Volt Starters, & 6 Volt Generators with Rivets, 3/4" 2 5/16"	
B9013-005	Red Delco Remy I.D. Tag (Blank)	\$7.00
	(Stamped)	\$14.25
	Red Delco-Remy I.D. Tag for 12 Volt Starters & 12 Volt Generators with Rivets, 3/4" 2 5/16"	
B9013-013	Delco Remy I.D. Tag (Blank)	\$7.00
	(Stamped)	\$14.25
	Black Delco-Remy I.D. Tag for Distributors, 6 Volt Starters, & 6 Volt Generators with Rivets, 3/4" 2 5/16"	

SWITCHES

B5010-018	Turn Signal Light Switch	\$73.50
	Universal Turn Signal Switch. Has right turn, left turn, and warning flasher modes. Metal Construction with Color Coded Wire Leads. Fuse, clamp ring, and instruction sheet included. Fits: Pre-1953 Vehicles	

ALTERNATORS

B6001-001	12 Volt Alternator (1 Wire)	\$112.75
63 Amp, Low Cut In, Specially Built For Tractors, Forklifts, & Other Low Engine Speed Applications		

CROFTON BUG

WIRING HARNESSSES

Crofton Bug, 6-Volt

B3119-001	Complete Wire Harness	\$563.33
------------------	------------------------------	-----------------

CROSLEY

SPARK PLUG WIRE SETS

Our Spark Plug Wire Sets Come Fully Assembled with the Proper Type Wire & Terminals.

They are Custom Tailored to Look & Fit Like Original Factory Equipment.

Varieties include:

Cotton Braid Wire: Copper Core with a Cotton Jacket.

EPDM Wire: Hi Performance Premium Conductor with a Tinned Copper Core, EPDM Silicone Insulation, and a Rubber Jacket.



Crosley 1939-1942 (Prewar)

2 Cyl. Tailored Spark Plug Wire Set

B1061-001	Original Type Cotton Braid Wire	\$28.75
B1061-001E	EPDM Wire	\$31.25

Crosley 1946-1952

4 Cyl. Tailored Spark Plug Wire Set

B1061-002	Original Type Cotton Braid Wire	\$36.50
B1061-002E	EPDM Wire	\$39.75

BATTERY CABLES



Our Battery Cables are made from the Proper Gauge Copper, as either **Black Cotton Braided Wire** or **PVC Wire** (whichever is correct for the application), using Soldered & Heat Sealed Brass or Copper Terminals.

Crosley 1939-1942 (Prewar)

B2061-001	Negative Battery Cable	\$35.75
B2000-006	Positive Ground Strap	\$13.50
B2061-002	Switch to Starter Cable	\$25.75

Crosley CC, CD 1946-1952

B2061-003	Negative Battery Cable	\$25.75
B2061-004	Positive Battery Cable (Bare)	\$32.50
B2061-005	Switch to Starter Cable	\$23.50

Crosley Farm-o-Road & Hot Shot 1949-1952

B2000-006	Positive Ground Strap	\$13.50
B2061-010	Negative Battery Cable (Bare)	\$38.00
B2061-009	Switch to Starter Cable	\$38.25



WIRING HARNESSSES

Our Wire Harnesses are made with our premium cotton braid and/or PVC wire. They have the correct gauge, color, wire, & fuse holders (if needed).

All terminals are soldered according to the original. (Harnesses do not include Battery Cables & Spark Plug Wires; however, we can supply these as separate products.)

NO HIDDEN COSTS, NOTHING EXTRA TO BUY!

Crosley 1939-1942 (Pre War)

B3061-001	Complete Wire Harness	\$426.50
------------------	-----------------------	-----------------

Crosley CC Late 1947-1948 (with Regulator)

B3061-002	Complete Wire Harness	\$810.50
------------------	-----------------------	-----------------

Crosley VC 1949-1952

B3061-003	Complete Wire Harness	\$981.50
------------------	-----------------------	-----------------

Crosley CD 1949-1952

B3061-004	Complete Wire Harness	\$953.75
------------------	-----------------------	-----------------

Crosley Farm-O-Road 1950-1952

B3061-005	Complete Wire Harness	\$953.75
------------------	-----------------------	-----------------

TUNE UP PARTS

Crosley 1939-1942

	B4001-002 Points Replaces: #IGW-3028S, 1-31	\$14.75
	B4002-005 Condenser Replaces: #2-24, 2-35, 2-22, 2-23	\$9.75
	B4004-016 Rotor Premium Grade, USA Replaces: #IGB-1002, 4-12	\$9.50
	B4003-023 Distributor Cap Made in the USA (Brass Contacts) Replaces: #IGB-1065C, 3-15, 3-49 #IGW-4199B, YF6-F	\$18.25



*For 6-Volt Ignition Coils & Accessories, see p.44

Crosley 1946-1952 All

	B4001-002 Points Replaces: #IGW-3028S, 1-31	\$14.75
	B4002-005 Condenser Replaces: #2-24, 2-35, 2-22, 2-23	\$9.75
	B4004-004 Rotor Premium Grade, Made in the USA Replaces: #4-15, IGB-1239	\$11.50
	B4003-004 Distributor Cap Premium Grade, Made in the USA (Brass Contacts) Replaces: #IGB-1241, IGB1241A, 3-21, 3-22	\$14.50

*For 6-Volt Ignition Coils & Accessories, see p.44

IDENTIFICATION TAGS

	B9013-001 Small Autolite I.D. Tag (Blank)	\$7.00
	Small Autolite I.D. Tag (Stamped)	\$14.25
2 5/16" Long, Black I.D. Tag for Distributors, Starters, & Generators with Rivets		
	B9013-002 Large Autolite I.D. Tag (Blank)	\$7.00
	Large Autolite I.D. Tag (Stamped)	\$14.25
2 15/16" Long, Black I.D. Tag for Distributors, Starters, & Generators with Rivets		

SWITCHES

B5010-018	Turn Signal Light Switch	\$73.50
	Universal Turn Signal Switch. Has right turn, left turn, and warning flasher modes. Metal Construction with Color Coded Wire Leads. Fuse, clamp ring, and instruction sheet included. Fits: Pre-1953 Vehicles	

ALTERNATORS

B6001-001	12 Volt Alternator (1 Wire)	\$112.75
63 Amp, Low Cut In, Specially Built For Tractors, Forklifts, & Other Low Engine Speed Applications		
B6001-005	6 Volt Alternator (1 Wire, Positive Ground)	\$166.50
6 Volt, 40 Amp Alternator with Positive Ground, 1 Wire, 3/8" pulley		

DESOTO

TABLE OF CONTENTS

Spark Plug Wire Sets _____	446
Battery Cables _____	446
Wiring Harnesses, Tune Up Parts _____	447
Electronic Ignition Conversion Kits _____	449
Cutout Relays & Voltage Regulators _____	449
Alternators _____	450
Identification Tags, Switches _____	450

SPARK PLUG WIRE SETS

Our Spark Plug Wire Sets Come Fully Assembled with the Proper Type Wire & Terminals.

They are Custom Tailored to Look & Fit Like Original Factory Equipment.

Varieties include:

Cotton Braid Wire: Copper Core with a Cotton Jacket.

PVC Wire: Copper Core with a Rubber Jacket.

EPDM Wire (E): Hi Performance Premium Conductor with a Tinned Copper Core, EPDM Silicone Insulation, and a Rubber Jacket.

Suppression Wire (S): for Electronic Ignition and is Spiral Wound, Low-Ohm, with EPDM Silicone Insulation and a Rubber Jacket.

Cotton Braid Suppression Wire (CS): also for Electronic Ignition, as Suppression Wire, but has an additional layer of Cotton Braid & Lacquer to replicate the vintage look, as well.



DeSoto 1929 Model K

6 Cyl. Tailored Spark Plug Wire Set

B1062-003	Original Type Cotton Braid Wire	\$50.75
B1062-003E	EPDM Wire	\$55.50
B1062-003S	Suppression Wire	\$55.50
B1062-003CS	Cotton Suppression Wire	\$87.50

DeSoto 1931 Model SA

6 Cyl. Tailored Spark Plug Wire Set

B1062-005	Original Type Cotton Braid Wire	\$50.75
------------------	--	----------------

DeSoto 1939-1947

6 Cyl. Tailored Spark Plug Wire Set

B1062-001	Original Type Cotton Braid Wire	\$53.75
B1062-001E	EPDM Wire	\$58.75
B1062-001S	Suppression Wire	\$58.75
B1062-001CS	Cotton Suppression Wire	\$92.75

DeSoto 1948-1954 (6-Cylinder)

6 Cyl. Tailored Spark Plug Wire Set

B1062-004	Original Type Cotton Braid Wire	\$50.75
B1062-004E	EPDM Wire	\$55.50
B1062-004S	Suppression Wire	\$55.50
B1062-004CS	Cotton Suppression Wire	\$87.50

DeSoto 1952-1955 (8-Cylinder)

8 Cyl. Tailored Spark Plug Wire Set

B1062-002	Original Type PVC Wire	\$61.75
B1062-002E	EPDM Wire	\$74.00

BATTERY CABLES



Our Battery Cables are made from the Proper Gauge Copper, as either **Black Cotton Braided Wire** or **PVC Wire** (whichever is correct for the application), using Soldered & Heat Sealed Brass or Copper Terminals.

DeSoto 8 Cyl. 1931

B2062-001	Negative Battery Cable	\$46.75
------------------	-------------------------------	----------------

DeSoto 6 Cyl. 1932

B2062-002	Negative Battery Cable	\$46.75
------------------	-------------------------------	----------------

DeSoto 1940

B2062-003	Positive Battery Cable	\$41.25
B2062-004	Negative Battery Cable	\$73.00

DeSoto 1941

B2062-005	Positive Battery Cable	\$41.25
B2062-006	Negative Battery Cable	\$47.75

DeSoto 1942

B2062-007	Positive Battery Cable	\$41.25
B2062-008	Negative Battery Cable	\$45.00

DeSoto 1946-1948

B2062-009	Positive Battery Cable	\$41.25
B2062-010	Negative Battery Cable	\$54.25

DeSoto 1949-1950

B2062-011	Positive Battery Cable	\$34.00
B2062-012	Negative Battery Cable	\$44.00

DeSoto 1951

B2062-013	Positive Battery Cable	\$41.25
B2062-014	Negative Battery Cable	\$54.25

DeSoto 6 Cyl. 1952

B2062-015	Positive Battery Cable	\$37.00
B2062-016	Negative Battery Cable	\$54.25

DeSoto 6 Cyl. 1953

B2062-017	Positive Battery Cable	\$37.00
B2062-022	Switch to Starter Cable	\$41.75

DeSoto 6 Cyl. 1953 (Torque Drive)

B2062-018	Negative Battery Cable	\$28.00
B2062-019	Switch to Starter Cable	\$41.75

DeSoto 6 Cyl. 1953 (Standard)

B2062-020	Positive Battery Cable	\$37.00
B2062-021	Negative Battery Cable	\$54.25

DeSoto 6 Cyl. 1954

B2062-023	Positive Battery Cable	\$37.00
B2062-024	Negative Battery Cable	\$28.00
B2062-025	Switch to Starter Cable	\$41.75

DeSoto 1952 V8

B2062-026	Positive Battery Cable	\$37.00
B2062-027	Negative Battery Cable	\$28.00
B2062-028	Switch to Starter Cable	\$46.50

DeSoto 1953-54 V8

B2062-029	Positive Battery Cable	\$37.00
B2062-030	Negative Battery Cable	\$28.00
B2062-031	Switch to Starter Cable	\$41.75

DeSoto 1955 V8

B2062-032	Positive Battery Cable	\$37.00
B2062-033	Negative Battery Cable	\$31.25
B2062-034	Switch to Starter Cable	\$41.75

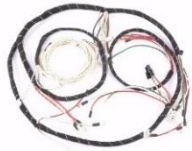

WIRING HARNESSSES

Our Wire Harnesses are made with our **premium cotton braid and/or PVC wire**. They have the **correct gauge, color, wire, & fuse holders** (if needed). All terminals are **soldered according to the original**. (Harnesses do not include Battery Cables & Spark Plug Wires; however, we can supply these as separate products.)
NO HIDDEN COSTS, NOTHING EXTRA TO BUY!

DeSoto 1956

B3062-001	Headlight Harness	\$76.25
------------------	-------------------	----------------

TUNE UP PARTS

DeSoto 6 Cylinder 1929-1932 with Delco Distributor

	B4001-021 Points Replaces: #1855520, D-109	\$13.75
	B4002-001 Condenser Replaces: #1928111, D-203, 1869704, D-200	\$4.75
	B4004-021 Rotor Replaces: #816774	\$14.75
	B4003-059 Cap Replaces: #816779, 822465, 1831800, 1853240	\$22.50

*For 6-Volt Ignition Coils & Accessories, see p.44



DeSoto 1930-1932

	B4003-028 Cap Top Quality USA Made With Brass Contacts Replaces: #1911556, D-302	\$26.25
---	---	----------------

	B4004-018 Rotor Replaces: #1836893	\$5.75
	B4007-001 Cap Clip Short Mount, 1 Used Replaces: #1889967, 1847289, 453844, 453461	\$11.95
	B4007-002 Cap Clip Long Mount, 1 Used Replaces: #1889967, 1889999, 453844, 453461	\$11.95
	B4009-001 Distributor Bushing & Shim Kit	\$25.99

*For 6-Volt Ignition Coils & Accessories, see p.44

DeSoto 6 Cylinder 1933-1934 with Delco Distributor 644J

	B4002-001 Condenser Replaces: #1928111, D-203, 1869704, D-200	\$4.75
	B4004-002 Rotor Replaces: #820445, D400	\$5.75

	B4003-002	\$20.25
Distributor Cap Premium Grade, Made in the USA (Brass Contacts) Replaces: #824735, D301		
	B4007-001	\$11.95
Cap Clip Short Mount, 1 Used Replaces: #1889967, 1847289, 453844, 453461		
	B4007-002	\$11.95
Cap Clip Long Mount, 1 Used Replaces: #1889967, 1889999, 453844, 453461		
	B4008-001	\$14.99
Distributor Insulator Replaces: #1904376		
	B4009-001	\$25.99
Distributor Bushing & Shim Kit		
B4006-001	Dust Cover	Replaces: #1900119 \$9.99

*For 6- or 12-Volt Ignition Coils & Accessories, see p.44

DeSoto 6 Cylinder 1935-1938

	B4001-002	\$14.75
Points Replaces: #IGW-3028S, 1-31		
	B4002-006	\$7.50
Condenser Replaces: #2-31, 2-38, 2-42, 2-95, IAT-1125S, IAT-3076BS, IBB-2042SS-1, IBB-2042-SS3, IG-3927F, IG-3927G, IG-3927K, IG-3927R		
	B4004-007	\$8.25
Rotor Premium Grade, Made in the USA Replaces: #4-19		
	B4003-007	\$25.00
Distributor Cap Premium Grade, Made in the USA (Brass Contacts) Replaces: #IGC-1107S, 3-23		

DeSoto 6 Cylinder 1939-1948

	B4001-005	\$9.75
Points Replaces: #1-4, 1-8, 1-9, 1-20, 1-22, 1-45, IAD-3128S, IGP-3028ES, IGP3028FS, IGS2224L, IGW3028AS		



	B4002-006	\$7.50
Condenser Replaces: #2-31, 2-38, 2-42, 2-95, IAT-1125S, IAT-3076BS, IBB-2042SS-1, IBB-2042-SS3, IG-3927F, IG-3927G, IG-3927K, IG-3927R		
	B4004-007	\$8.25
Rotor Premium Grade, Made in the USA Replaces: #4-19		
	B4003-007	\$25.00
Distributor Cap Premium Grade, Made in the USA (Brass Contacts) Replaces: #IGC-1107S, 3-23		



*For 6-Volt Ignition Coils & Accessories, see p.44

DeSoto 6 Cylinder 1949-1950 with IAP Distributor

	B4001-005	\$9.75
Points Replaces: #1-4, 1-8, 1-9, 1-20, 1-22, 1-45, IAD-3128S, IGP-3028ES, IGP3028FS, IGS2224L, IGW3028AS		
	B4003-035	\$31.50
Cap Replaces: #IAO-1003, 3-1		
	B4002-002	\$4.75
Condenser Replaces: #2-23, 2-31, 2-32, 2-34, 2-38, 2-42, IAT-2015L, IAT-2015R, IAT-3076AS, IAT-3076BS, IAT-3076D, IAT-3076DS, IAT-3076L, IAT-3076LA, IAT-3076R, IAT-3076RA, IBB-2015L, IBB-2015R, IBB-2042-SS, IBB-2042SS-1, IBB-2042-SS3, IG-2671F, IGH-3076, IGW-3139, 2098058, 3420600		
	B4004-007	\$8.25
Rotor Premium Grade, Made in the USA Replaces: #4-19		

DeSoto 6 Cylinder 1949-1950 w/ IAT Distributor

	B4001-022	\$16.75
Points Replaces: #IGS-2224, 1-44, 2084075		
	B4002-002	\$4.75
Condenser Replaces: (See above)		

	B4003-036	\$13.50
	Cap Replaces: #IAT-1033, IAT-1033A, IAT-1033C, 3-4, 3-34, 3-37	
	B4004-025	\$6.75
	Rotor Replaces: #IAT-1016	

*For 6-Volt Ignition Coils & Accessories, see p.44

DeSoto 1952-1955

	B4001-023	\$19.75
	Points *2 Required- Each Sold Separately* Replaces: #IAZ-2040RS, 1-19, 1-26, 1-41, IAZ-2040RS, IGP-3028ZS, IGW-3028KS	

B4002-002	\$4.75
------------------	---------------

	Condenser Replaces: #2-23, 2-31, 2-32, 2-34, 2-38, 2-42, IAT-2015L, IAT-2015R, IAT-3076AS, IAT-3076BS, IAT-3076D, IAT-3076DS, IAT-3076L, IAT-3076LA, IAT-3076R, IAT-3076RA, IBB-2015L, IBB-2015R, IBB-2042-SS, IBB-2042SS-1, IBB-2042-SS3, IG-2671F, IGH-3076, IGW-3139, 2098058, 3420600	
---	---	--

	B4003-035	\$31.50
	Cap Replaces: #IAO-1003, 3-1	

	B4004-027	\$7.75
	Rotor Replaces: #4-17	

DeSoto 8 Cylinder 1956

B4002-002	\$4.75
------------------	---------------

	Condenser Replaces: #2-23, 2-31, 2-32, 2-34, 2-38, 2-42, IAT-2015L, IAT-2015R, IAT-3076AS, IAT-3076BS, IAT-3076D, IAT-3076DS, IAT-3076L, IAT-3076LA, IAT-3076R, IAT-3076RA, IBB-2015L, IBB-2015R, IBB-2042-SS, IBB-2042SS-1, IBB-2042-SS3, IG-2671F, IGH-3076, IGW-3139, 2098058, 3420600	
---	---	--

	B4004-027	\$7.75
	Rotor Replaces: #4-17	

Desoto 8 Cylinder 1957 & Later
(Call For Availability)

**ELECTRONIC IGNITION
CONVERSION KITS**

Replaces Points & Condenser



DeSoto 6 Cylinder 1929-1932 with Delco Distributor		
B9600-309	12 Volt Negative Ground	\$154.95
B9600-309P6	6 Volt Positive Ground	\$169.45

DeSoto 6 Cyl. 1933-1934 with Delco Distributor 644J		
B9600-255LS	12 Volt Negative Ground	\$162.45
B9600-255LSP12	12 Volt Positive Ground	\$175.45
B9600-255LSP6	6 Volt Positive Ground	\$175.45

DeSoto 6 Cyl. 1935-1942 & 1946-1950 All with Autolite IGS, IAP Series Distributor		
B9600-307LS	12 Volt Negative Ground	\$169.45
B9600-307LSP6	6 Volt Positive Ground	\$185.95





***For Ignition Coils & Accessories, see p.44**

**CUTOUT RELAYS
& VOLTAGE REGULATORS**

Note: Due to modern battery design, voltage regulators can't be used to charge low or dead batteries. Doing so will destroy the voltage regulator and void the warranty.

B8001-001	6-Volt Cutout Relay	\$19.50
	15 Amps, 6 Volt Works Positive or Negative Ground Replaces: Autolite - CB4014, C4012(9-5), C4012(9-4), C4012(9-1), R40061 Delco - #266P, 266N, 265P, 265N, 5015850, 812970, 265J, 820845, 812971, 1116816, 265G, 265H, 1116755, 1116751, 1116809DR, 265B, 1842859, 265C, 1867781, 265F, 265D Fits: Desoto - 6 Cyl. All 1929 to 1933	

B8001-002	Electronic Cutout Relay	\$19.50
	25 Amp, Works with 6, 12, or 24 Volts. & Positive or Negative Ground Replaces: Autolite - #CB4014, C4012(9-5), C4012(9-4), C4012(9-1), R40061 Delco - #266P, 266N, 265P, 265N, 5015850, 812970, 265J, 820845, 812971, 1116816, 265G, 265H, 1116755, 1116751, 1116809DR, 265B, 1842859, 265C, 1867781, 265F, 265D Fits: Desoto - 6 Cyl. All 1929 to 1933	

B8002-028	6-Volt Autolite Type Voltage Regulator	\$158.60
	6 Volt, 3 Terminal, Flat Mounting Bracket Regulator (Premium Quality Made in the USA) Replaces: Prestolite - #8-117, 8-70, 8-74, GRX-761, VBE-6102A, VBE-6104A, VBO-4601F, VBO-4601K, VBO-4602B, VBO-4602R, VRB-4002C, VRP-4001A, VRP-4001B, VRP-4002D, VRP-4003A, VRP-4003B, VRP-4004A, VRP-4004C, VRP-4004F, VRP-4008A, VRP-6001A, VRP-6001B, VRP-6002A, VRP-6005A, VRP-6101A, VRP-6101B Chrysler - #1120515, 1121978, 1257394, 1321757, 1343573, 1571161, 2095209, 871763 Fits: Desoto - 1939 to 1949 (All Except 1949 GOZ Generator)	

B8002-031	6-Volt Autolite Type Voltage Regulator	\$144.88
	6 Volt, 3 Terminal, Flat Mounting Bracket Regulator. Positive Ground. (Premium Quality Made in the USA) Replaces: Chrysler - #1311467, 1343753, 1502074, 1641510 Delco - #A602, A602M Prestolite - #8-76, 8-762, VBE-6001A, VBE-6101, VBE-6201A, VBO-4602E, VBO-4602V Fits: Desoto - 6 Cyl. 1951-1955 (All with 6 Volt System), 8 Cyl. 1951-1955 (All with 6 Volt System)	



B8002-008	6-Volt Autolite Type Voltage Regulator	\$69.75
	12 Volt, 3 Terminal, Flat Mounting (Premium Quality, Made in the USA) Replaces: Prestolite - #8-154, 8-414, 8-58, 8-59, 8-722, 8-85, GRX-722, VBO-4201E, VBO-4202A, VBO-4202B, VBO-4202P, VBO-4202R, VR-6301A, VRX-6010, VRX-6010A Chrysler - #1642333, 1842798, 1889944, 2095341, 2095531 Delco - #1972029, 1972061, A600, A600M, A605, A605M Fits: Desoto - 1956-1960	



ALTERNATORS

B6001-001	12 Volt Alternator (1 Wire)	\$112.75
63 Amp, Low Cut In, Specially Built For Tractors, Forklifts, & Other Low Engine Speed Applications		
B6001-002	12 Volt Alternator (1 Wire/ 3 Wire)	\$118.75
63 Amp, With 1 Wire Or 3 Wire For Warning Lamp On Automobiles & Trucks		
B6001-005	6 Volt Alternator (1 Wire, Positive Ground)	\$166.50
6 Volt, 40 Amp Alternator with Positive Ground, 1 Wire, 3/8" pulley		

IDENTIFICATION TAGS

	B9013-001 Small Autolite I.D. Tag (Blank)	\$7.00
	Small Autolite I.D. Tag (Stamped)	\$14.25
		2 5/16" Long, Black I.D. Tag for Distributors, Starters, & Generators with Rivets
	B9013-002 Large Autolite I.D. Tag (Blank)	\$7.00
	Large Autolite I.D. Tag (Stamped)	\$14.25
		2 15/16" Long, Black I.D. Tag for Distributors, Starters, & Generators with Rivets

SWITCHES

B5010-018	Turn Signal Light Switch	\$73.50
	Universal Turn Signal Switch. Has right turn, left turn, and warning flasher modes. Metal Construction with Color Coded Wire Leads. Fuse, clamp ring, and instruction sheet included. Fits: Pre-1953 Vehicles	

STARTER SWITCHES

B5006-004	Starter Switch	\$11.75
	6 or 12 Volt Starter Mounted Manual Push Button Starter Switch Fits: Desoto - 1930-1932	

DIAMOND T SPARK PLUG WIRE SETS

Diamond T 1946-1949 with Hercules JXD
6 Cyl. Tailored Spark Plug Wire Set

B1063-002	Original Type Cotton Braid Wire	\$46.00
B1063-002E	EPDM Wire	\$50.25
B1063-002S	Suppression Wire	\$50.25
B1063-002CS	Cotton Suppression Wire	\$79.00

Diamond T 1948-1949 with Hercules QXD3
6 Cyl. Tailored Spark Plug Wire Set



B1063-001	Original Type Cotton Braid Wire	\$46.00
B1063-001E	EPDM Wire	\$50.25
B1063-001S	Suppression Wire	\$50.25
B1063-001CS	Cotton Suppression Wire	\$79.00

TUNE UP PARTS

Diamond T 1929-1932, 4 Cylinder w/ Buda Engine
HP199, or HP217 & Autolite Distributor #IGB-4035

	B4001-002 Points Replaces: #IGW-3028S, 1-31	\$14.75
	B4002-005 Condenser Replaces: #2-24, 2-35, 2-22, 2-23	\$9.75
	B4003-040 Cap Replaces: #IGB-1241	\$28.75
	B4004-004 Rotor Premium Grade, Made in the USA Replaces: #4-15, IGB-1239	\$11.50

Diamond T 6 Cylinder with Autolite Distributor #IGB-4055 & Model 201
1939-1949 6 Cylinder with Hercules QLXD3 Engine & Autolite Distributor #IGW-6001-2

	B4001-002 Points Replaces: #IGW-3028S, 1-31	\$14.75
	B4002-005 Condenser Replaces: #2-24, 2-35, 2-22, 2-23	\$9.75
	B4003-027 Cap Replaces: #ICB-1240, 3-20	\$21.75

	B4004-004 Rotor Premium Grade, USA Made Replaces: #4-15, IGB-1239	\$11.50
--	---	----------------

ELECTRONIC IGNITION KITS

Diamond T 6 Cyl. 1939-1949 Model 201 Trucks
with Hercules QLXD 3 Engine & Autolite Distributor #IGW-6001-2

B9600-071	12 Volt Negative Ground	\$206.45
B9600-071N6	6 Volt Negative Ground	\$220.95
B9600-071P6	6 Volt Positive Ground	\$220.95

IDENTIFICATION TAGS

B9013-001	Small Autolite I.D. Tag (Blank)	\$7.00
	Small Autolite I.D. Tag (Stamped)	\$14.25
2 5/16" Long, Black I.D. Tag for Distributors, Starters, & Generators with Rivets		

B9013-002	Large Autolite I.D. Tag (Blank)	\$7.00
	Large Autolite I.D. Tag (Stamped)	\$14.25
2 15/16" Long, Black I.D. Tag for Distributors, Starters, & Generators with Rivets		

SWITCHES

B5010-018	Turn Signal Light Switch	\$73.50
	Universal Turn Signal Switch. Has right turn, left turn, and warning flasher modes. Metal Construction with Color Coded Wire Leads. Fuse, clamp ring, and instruction sheet included. Fits: Pre-1953 Vehicles	

SOLENOIDS

B5007-042	6-Volt Delco Starter Solenoid Switch	\$52.75
	Replaces: Delco - #1114307, 1114310, 1114312, 1114410, 1118135, 1118140, 1118148, D936, D938, D939, D949, D964 Prestolite - #15-228, SWX-228, SWX-429 Fits: Diamond T - 6 Cyl. 1955-1958	

ALTERNATORS

B6001-001	12 Volt Alternator (1 Wire)	\$112.75
	63 Amp, Low Cut In, Specially Built For Tractors, Forklifts, & Other Low Engine Speed Applications	

DODGE CAR

TABLE OF CONTENTS

Spark Plug Wire Sets	452
Battery Cables	452
Wire Harnesses	453
Tune Up Parts	453
Electronic Ignition Conversion Kits	460
Cutout Relays & Voltage Regulators	460
Switches	461
Identification Tags	461
Alternators	461
Carburetor Rebuild Kits	461

SPARK PLUG WIRE SETS

Our Spark Plug Wire Sets Come Fully Assembled with the Proper Type Wire & Terminals.

They are Custom Tailored to Look & Fit Like Original Factory Equipment.

Varieties include:

Cotton Braid Wire: Copper Core with a Cotton Jacket.

PVC Wire: Copper Core with a Rubber Jacket.

EPDM Wire (E): Hi Performance Premium Conductor with a Tinned Copper Core, EPDM Insulation, Rubber Jacket.

Suppression Wire (S): for Electronic Ignition and is Spiral Wound, Low-Ohm, with EPDM Silicone Insulation and a Rubber Jacket.

Cotton Braid Suppression Wire (CS): also for Electronic Ignition, as Suppression Wire, but has an additional layer of Cotton Braid & Lacquer to replicate the vintage look, as well.



Dodge 1926

4 Cyl. Tailored Spark Plug Wire Set

B1064-001	Original Type Cotton Braid Wire	\$50.75
B1064-001E	EPDM Wire	\$55.50
B1064-001S	Suppression Wire	\$55.50
B1064-001CS	Cotton Suppression Wire	\$87.50

Dodge 1939-1947

6 Cyl. Tailored Spark Plug Wire Set

B1064-002	Original Type Cotton Braid Wire	\$53.75
B1064-002E	EPDM Wire	\$58.75
B1064-002S	Suppression Wire	\$58.75
B1064-002CS	Cotton Suppression Wire	\$92.75

Dodge 1948-1954 (6-Cylinder)

6 Cyl. Tailored Spark Plug Wire Set

B1064-003	Original Type Cotton Braid Wire	\$50.75
B1064-003E	EPDM Wire	\$55.50
B1064-003S	Suppression Wire	\$55.50
B1064-003CS	Cotton Suppression Wire	\$87.50

Dodge 1952-1954 (8-Cylinder)

8 Cyl. Tailored Spark Plug Wire Set

B1064-004	Original Type PVC Wire	\$61.75
B1064-004E	EPDM Wire	\$74.00
B1064-004S	Suppression Wire	\$74.00

Dodge 1955 Cornet, Royal

8 Cyl. Tailored Spark Plug Wire Set

B1064-005	Original Type PVC Wire	\$61.75
B1064-005E	EPDM Wire	\$74.00
B1064-005S	Suppression Wire	\$74.00

Dodge 1955 Custom Royal

8 Cyl. Tailored Spark Plug Wire Set

B1064-006	Original Type PVC Wire	\$61.75
B1064-006E	EPDM Wire	\$74.00
B1064-006S	Suppression Wire	\$74.00

Dodge 1960-1962 V8 with Ram Air

& Dodge 1965-1972 V8 with 361 cid, 383 cid,

400 cid, 440 cid Engines

8 Cyl. Tailored Spark Plug Wire Set

B1064-007	Original Type PVC Wire	\$67.50
B1064-007E	EPDM Wire	\$81.00
B1064-007S	Suppression Wire	\$81.00

BATTERY CABLES



Our Battery Cables are made from the Proper Gauge Copper, as either **Black Cotton Braided Wire** or **PVC Wire** (whichever is correct for the application), using Soldered & Heat Sealed Brass or Copper Terminals.

Dodge Car 1921 With Original Armor

B2064-028	Positive Ground Cable	\$36.50
B2064-029	Negative Battery Cable	\$56.75
B2064-030	Switch to Starter Cable	\$72.25

Dodge Car 1925

B2064-001	Positive Battery Cable	\$35.00
B2064-002	Negative Battery Cable with Original Armor	\$55.00
B2064-003	Switch to Starter Cable with Original Armor	\$56.75

Dodge Car 1940

B2064-004	Positive Battery Cable	\$41.25
B2064-005	Negative Battery Cable	\$73.00

Dodge Car 1941

B2064-006	Positive Battery Cable	\$41.25
B2064-007	Negative Battery Cable	\$47.75

Dodge Car 1942

B2064-008	Positive Battery Cable	\$41.25
B2064-009	Negative Battery Cable	\$45.00

Dodge Car 1946-1948

B2064-010	Positive Battery Cable	\$41.25
B2064-011	Negative Battery Cable	\$33.25
B2064-012	Switch to Starter Cable	\$29.75

Dodge Car 6 Cyl. 1949-1952

B2064-013	Positive Battery Cable	\$34.00
B2064-014	Negative Battery Cable	\$31.25
B2064-015	Switch to Starter Cable	\$29.75

Dodge Car 6 Cyl. 1953-1954

B2064-016	Positive Battery Cable	\$37.00
B2064-017	Negative Battery Cable	\$34.00
B2064-018	Switch to Starter Cable	\$32.00

Dodge Car 1953-1954 V8

B2064-019	Positive Battery Cable	\$33.25
B2064-020	Negative Battery Cable	\$34.00
B2064-021	Switch to Starter Cable	\$32.00

Dodge Car 6 Cyl. 1955

B2064-022	Positive Battery Cable	\$37.00
B2064-023	Negative Battery Cable	\$33.25
B2064-024	Switch to Starter Cable	\$32.00

Dodge Car 1955 V8

B2064-025	Positive Battery Cable	\$37.00
B2064-026	Negative Battery Cable	\$33.25
B2064-027	Switch to Starter Cable	\$38.00



WIRING HARNESSSES

Our Wire Harnesses are made with our **premium cotton braid and/or PVC wire**. They have the **correct gauge, color, wire, & fuse holders** (if needed). All terminals are **soldered according to the original**.
(Harnesses do not include Battery Cables & Spark Plug Wires; however, we can supply these as separate products.)
NO HIDDEN COSTS, NOTHING EXTRA TO BUY!

Dodge Car 1946-1948 4-Door

B3064-001	Complete Wire Harness	\$1,009.50
------------------	-----------------------	-------------------



Dodge Car 1953



B3064-002	Engine Harness with Cornet Engine	\$159.75
------------------	-----------------------------------	-----------------

Note

When ordering, please specify **Year** or **Serial Number**, Magneto/Distributor, & Regulator/Cut Out Relay. Some Harnesses were originally made with PVC Wire & Braided; others were made with PVC Wire & Taped. In those cases, we build them the **Original Way**.

TUNE UP PARTS



Dodge 6 Cylinder 1929-1932 (with Delco Distributor 622H, 632D, 632K, 662H)		
	B4001-021	\$13.75
	Points Replaces: #1855520, D-109	
	B4002-001	\$4.75
	Condenser Replaces: #1928111, D-203, 1869704, D-200	

	B4004-021	\$14.75
	Rotor Replaces: #816774	
	B4003-059	\$22.50
	Cap Replaces: #816779, 822465, 1831800, 1853240	

***For 6-Volt Ignition Coils & Accessories, see p.44**

Dodge 6 Cylinder 1933-1934		
	B4100-001	\$10.50
	PCR Kit Includes: Points (#B4001-001), Condenser (#B4002-001), Rotor (#B4004-002) Replaces: Points - #D100HP, 1855720 Condenser - #1928111, D-203, 1869704, D-200 Rotor - #820445, D400	
	B4004-002	\$5.75
	Rotor Replaces: #820445, D400	
	B4003-002	\$20.25
	Distributor Cap Premium Grade, Made in the USA (Brass Contacts) Replaces: #824735, D301	
	B4007-001	\$11.95
	Cap Clip Short Mount, 1 Used Replaces: #1889967, 1847289, 453844, 453461	
	B4007-002	\$11.95
	Cap Clip Long Mount, 1 Used Replaces: #1889967, 1889999, 453844, 453461	
	B4008-001	\$14.99
	Distributor Insulator Replaces: #1904376	
	B4009-001	\$25.99
	Distributor Bushing & Shim Kit	
B4006-001	Dust Cover	Replaces: #1900119 \$9.99

*For 6- or 12-Volt Ignition Coils & Accessories, see p.44

Dodge 6 Cylinder 1935-1938		
	B4001-002	\$14.75
	Points Replaces: #IGW-3028S, 1-31	
	B4002-006	\$7.50
	Condenser Replaces: #2-31, 2-38, 2-42, 2-95, IAT-1125S, IAT-3076BS, IBB-2042SS-1, IBB-2042-SS3, IG-3927F, IG-3927G, IG-3927K, IG-3927R	
	B4004-007	\$8.25
	Rotor Premium Grade, Made in the USA Replaces: #4-19	

	B4003-007	\$25.00
	Distributor Cap Premium Grade, Made in the USA (Brass Contacts) Replaces: #IGC-1107S, 3-23	

*For 6-Volt Ignition Coils & Accessories, see p.44

Dodge 6 Cylinder 1939-1942, 1946-1948, & 1950 with IGS Distributor		
	B4001-005	\$9.75
	Points Replaces: #1-4, 1-8, 1-9, 1-20, 1-22, 1-45, IAD-3128S, IGP-3028ES, IGP3028FS, IGS2224L, IGW3028AS	
	B4002-006	\$7.50
	Condenser Replaces: #2-31, 2-38, 2-42, 2-95, IAT-1125S, IAT-3076BS, IBB-2042SS-1, IBB-2042-SS3, IG-3927F, IG-3927G, IG-3927K, IG-3927R	
	B4004-007	\$8.25
	Rotor Premium Grade, Made in the USA Replaces: #4-19	
	B4003-007	\$25.00
	Distributor Cap Premium Grade, Made in the USA (Brass Contacts) Replaces: #IGC-1107S, 3-23	

*For 6-Volt Ignition Coils & Accessories, see p.44

Dodge 6 Cylinder 1946-1950 (with IAP, & IAS Distributor)		
	B4001-005	\$9.75
	Points Replaces: #1-4, 1-8, 1-9, 1-20, 1-22, 1-45, IAD-3128S, IGP-3028ES, IGP3028FS, IGS2224L, IGW3028AS	
B4002-002		\$4.75
	Condenser Replaces: #2-23, 2-31, 2-32, 2-34, 2-38, 2-42, IAT-2015L, IAT-2015R, IAT-3076AS, IAT-3076BS, IAT-3076D, IAT-3076DS, IAT-3076L, IAT-3076LA, IAT-3076R, IAT-3076RA, IBB-2015L, IBB-2015R, IBB-2042-SS, IBB-2042SS-1, IBB-2042-SS3, IG-2671F, IGH-3076, IGW-3139, 2098058, 3420600	
	B4003-035	\$31.50
	Cap Replaces: #IAO-1003, 3-1	
	B4004-007	\$8.25
	Rotor Premium Grade, Made in the USA Replaces: #4-19	

*For 6-Volt Ignition Coils & Accessories, see p.44

Dodge 6 Cylinder 1950 (with IAT Distributor), 1956-1958 (All)		
	B4001-022 Points Replaces: #IGS-2224, 1-44, 2084075	\$16.75
B4002-002		\$4.75
	Condenser Replaces: #2-23, 2-31, 2-32, 2-34, 2-38, 2-42, IAT-2015L, IAT-2015R, IAT-3076AS, IAT-3076BS, IAT-3076D, IAT-3076DS, IAT-3076L, IAT-3076LA, IAT-3076R, IAT-3076RA, IBB-2015L, IBB-2015R, IBB-2042-SS, IBB-2042SS-1, IBB-2042-SS3, IG-2671F, IGH-3076, IGW-3139, 2098058, 3420600	
	B4003-036 Cap Replaces: #IAT-1033, IAT-1033A, IAT-1033C, 3-4, 3-34, 3-37	\$13.50
	B4004-026 Rotor Replaces: #IAU-1016A, 4-4	\$6.75

*For 6-Volt Ignition Coils & Accessories, see p.44

Dodge 6 Cylinder 1959		
	B4001-022 Points Replaces: #IGS-2224, 1-44, 2084075	\$16.75
B4002-002		\$4.75
	Condenser Replaces: #2-23, 2-31, 2-32, 2-34, 2-38, 2-42, IAT-2015L, IAT-2015R, IAT-3076AS, IAT-3076BS, IAT-3076D, IAT-3076DS, IAT-3076L, IAT-3076LA, IAT-3076R, IAT-3076RA, IBB-2015L, IBB-2015R, IBB-2042-SS, IBB-2042SS-1, IBB-2042-SS3, IG-2671F, IGH-3076, IGW-3139, 2098058, 3420600	
	B4003-036 Cap Replaces: #IAT-1033, IAT-1033A, IAT-1033C, 3-4, 3-34, 3-37	\$13.50
	B4004-026 Rotor Replaces: #IAU-1016A, 4-4	\$6.75



*For 6-Volt Ignition Coils & Accessories, see p.44



Dodge 6 Cylinder 1960 Canada Models		
	B4001-022 Points Replaces: #IGS-2224, 1-44, 2084075	\$16.75
	B4002-006 Condenser Replaces: #2-31, 2-38, 2-42, 2-95, IAT-1125S, IAT-3076BS, IBB-2042SS-1, IBB-2042-SS3, IG-3927F, IG-3927G, IG-3927K, IG-3927R	\$7.50
	B4003-036 Cap Replaces: #IAT-1033, IAT-1033A, IAT-1033C, 3-4, 3-34, 3-37	\$13.50
	B4004-026 Rotor Replaces: #IAU-1016A, 4-4	\$6.75

*For 6-Volt Ignition Coils & Accessories, see p.44

Dodge 6 Cylinder 1960-1961 (Except Canada Models)		
	B4001-025 Points Replaces: #2098244	\$6.50
B4002-002		\$4.75
	Condenser Replaces: #2-23, 2-31, 2-32, 2-34, 2-38, 2-42, IAT-2015L, IAT-2015R, IAT-3076AS, IAT-3076BS, IAT-3076D, IAT-3076DS, IAT-3076L, IAT-3076LA, IAT-3076R, IAT-3076RA, IBB-2015L, IBB-2015R, IBB-2042-SS, IBB-2042SS-1, IBB-2042-SS3, IG-2671F, IGH-3076, IGW-3139, 2098058, 3420600	
	B4004-029 Rotor Replaces: #4-1C, 4-16, 297981, 1394885, 1838516, 2098770, 2716867, 3874401, 4106104, 12309507, 312769607, C401, C401Z, C403, C411, CH308, CH310, CH312, CH317, CH403, DRC303, DRC329, XA921	\$5.75

*For 6-Volt Ignition Coils & Accessories, see p.44



Dodge 6 Cylinder 1960-1963 All (with Autolite Distributor IBP-4005FS)		
	B4001-017 Points Replaces: #IBP-2040L, IBP-3028BS, 1-33, 1-47V, 1-48	\$6.50
	B4002-006 Condenser Replaces: #2-31, 2-38, 2-42, 2-95, IAT-1125S, IAT-3076BS, IBB-2042SS-1, IBB-2042-SS3, IG-3927F, IG-3927G, IG-3927K, IG-3927R	\$7.50

	B4003-070	\$10.75
	Cap Replaces: #IBR-1003B, 3-109	
	B4004-045	\$9.75
	Rotor Replaces: #IBR-1016, 4-25	

*For 12-Volt Ignition Coils & Accessories, see p.44

Dodge 6 Cylinder 1960-1966 All (with Autolite Distributor IBR-4201)		
	B4001-022	\$16.75
	Points Replaces: #IGS-2224, 1-44, 2084075	
	B4002-006	\$7.50
	Condenser Replaces: #2-31, 2-38, 2-42, 2-95, IAT-1125S, IAT-3076BS, IBB-2042SS-1, IBB-2042-SS3, IG-3927F, IG-3927G, IG-3927K, IG-3927R	
	B4003-070	\$10.75
	Cap Replaces: #IBR-1003B, 3-109	
	B4004-045	\$9.75
	Rotor Replaces: #IBR-1016, 4-25	

*For 12-Volt Ignition Coils & Accessories, see p.44

Dodge 6 Cylinder 1962-1969 (Except Canada Models)		
	B4001-025	\$6.50
	Points Replaces: #2098244	
	B4002-002	\$4.75
	Condenser Replaces: #2-23, 2-31, 2-32, 2-34, 2-38, 2-42, IAT-2015L, IAT-2015R, IAT-3076AS, IAT-3076BS, IAT-3076D, IAT-3076DS, IAT-3076L, IAT-3076LA, IAT-3076R, IAT-3076RA, IBB-2015L, IBB-2015R, IBB-2042-SS, IBB-2042SS-1, IBB-2042-SS3, IG-2671F, IGH-3076, IGW-3139, 2098058, 3420600	
	B4003-042	\$8.00
	Cap Replaces: #2098765, 1889424	

	B4004-029	\$5.75
	Rotor Replaces: #4-1C, 4-16, 297981, 1394885, 1838516, 2098770, 2716867, 3874401, 4106104, 12309507, 312769607, C401, C401Z, C403, C411, CH308, CH310, CH312, CH317, CH403, DRC303, DRC329, XA921	

*For 6-Volt Ignition Coils & Accessories, see p.44

Dodge 8 Cylinder 1930-1933		
	B4001-006	\$11.75
	Points Replaces: #1882022	
	B4002-001	\$4.75
	Condenser Replaces: #1928111, D-203, 1869704, D-200	
	B4003-028	\$26.25
	Cap Top Quality USA Made with Brass Contacts Replaces: #1911556, D-302	
	B4004-018	\$5.75
	Rotor Replaces: #1836893	
	B4007-001	\$11.95
	Cap Clip Short Mount, 1 Used Replaces: #1889967, 1847289, 453844, 453461	
	B4007-002	\$11.95
	Cap Clip Long Mount, 1 Used Replaces: #1889967, 1889999, 453844, 453461	
	B4009-001	\$25.99
	Distributor Bushing & Shim Kit	

*For 6-Volt Ignition Coils & Accessories, see p.44

Dodge Straight 8 Cylinder 1931 with Dual Points and Delco 660 G Distributor		
	B4001-007	\$49.75
	Points Dual Point set Consists of 1 set each, left & right hand Replaces: #1882022	
	B4002-001	\$4.75
	Condenser Replaces: #1928111, D-203, 1869704, D-200	
	B4003-028	\$26.25
	Cap Top Quality USA Made With Brass Contacts Replaces: #1911556, D-302	
	B4004-018	\$5.75
	Rotor Replaces: #1836893	

	B4007-001 Cap Clip Short Mount, 1 Used Replaces: #1889967, 1847289, 453844, 453461	\$11.95
	B4007-002 Cap Clip Long Mount, 1 Used Replaces: #1889967, 1889999, 453844, 453461	\$11.95
	B4009-001 Distributor Bushing & Shim Kit	\$25.99

Dodge 8 Cylinder 1953-1955

	B4001-023 Points *2 Required- Each Sold Separately* Replaces: #IAZ-2040RS, 1-19, 1-26, 1-41, IAZ-2040RS, IGP-3028ZS, IGW-3028KS	\$19.75
B4002-002	Condenser Replaces: #2-23, 2-31, 2-32, 2-34, 2-38, 2-42, IAT-2015L, IAT-2015R, IAT-3076AS, IAT-3076BS, IAT-3076D, IAT-3076DS, IAT-3076L, IAT-3076LA, IAT-3076R, IAT-3076RA, IBB-2015L, IBB-2015R, IBB-2042-SS, IBB-2042SS-1, IBB-2042-SS3, IG-2671F, IGH-3076, IGW-3139, 2098058, 3420600	\$4.75
	B4003-038 Cap Replaces: #IAR-1003, 3-2	\$31.75
	B4004-027 Rotor Replaces: #4-17	\$7.75



*For 6-Volt Ignition Coils & Accessories, see p.44

Dodge 8 Cylinder 1956

B4002-002	Condenser Replaces: #2-23, 2-31, 2-32, 2-34, 2-38, 2-42, IAT-2015L, IAT-2015R, IAT-3076AS, IAT-3076BS, IAT-3076D, IAT-3076DS, IAT-3076L, IAT-3076LA, IAT-3076R, IAT-3076RA, IBB-2015L, IBB-2015R, IBB-2042-SS, IBB-2042SS-1, IBB-2042-SS3, IG-2671F, IGH-3076, IGW-3139, 2098058, 3420600	\$4.75
	B4003-039 Cap Replaces: #IBN-1003, 3-8, 3-35	\$18.75
	B4004-028 Rotor Replaces: #1658535, 41059, 3926326, 980892, R103003, IBK1016, 4-7	\$6.25

*For 12-Volt Ignition Coils & Accessories, see p.44

Dodge 8 Cylinder 1957 (Dual Points)

	B4001-023 Points *2 Required- Each Sold Separately* Replaces: #IAZ-2040RS, 1-19, 1-26, 1-41, IAZ-2040RS, IGP-3028ZS, IGW-3028KS	\$19.75
B4002-002	Condenser Replaces: #2-23, 2-31, 2-32, 2-34, 2-38, 2-42, IAT-2015L, IAT-2015R, IAT-3076AS, IAT-3076BS, IAT-3076D, IAT-3076DS, IAT-3076L, IAT-3076LA, IAT-3076R, IAT-3076RA, IBB-2015L, IBB-2015R, IBB-2042-SS, IBB-2042SS-1, IBB-2042-SS3, IG-2671F, IGH-3076, IGW-3139, 2098058, 3420600	\$4.75
	B4003-039 Cap Replaces: #IBN-1003, 3-8, 3-35	\$18.75
	B4004-028 Rotor Replaces: #1658535, 41059, 3926326, 980892, R103003, IBK1016, 4-7	\$6.25

Dodge 8 Cylinder 1957 (Single Points), 1958 (Except Coronet), 1959 Coronet (With Single Points)

	B4001-008 Points Replaces: #IBP-2040R, IBP-3028AS, 1-32, 1-46	\$4.75
B4002-002	Condenser Replaces: #2-23, 2-31, 2-32, 2-34, 2-38, 2-42, IAT-2015L, IAT-2015R, IAT-3076AS, IAT-3076BS, IAT-3076D, IAT-3076DS, IAT-3076L, IAT-3076LA, IAT-3076R, IAT-3076RA, IBB-2015L, IBB-2015R, IBB-2042-SS, IBB-2042SS-1, IBB-2042-SS3, IG-2671F, IGH-3076, IGW-3139, 2098058, 3420600	\$4.75
	B4003-039 Cap Replaces: #IBN-1003, 3-8, 3-35	\$18.75
	B4004-028 Rotor Replaces: #1658535, 41059, 3926326, 980892, R103003, IBK1016, 4-7	\$6.25

*For 12-Volt Ignition Coils & Accessories, see p.44

Dodge 8 Cylinder 1958 Coronet, 1959 Royal 500 (with Single Points)		
	B4001-017	\$6.50
	Points Replaces: #IBP-2040L, IBP-3028BS, 1-33, 1-47V, 1-48	
B4002-002		\$4.75
	Condenser Replaces: #2-23, 2-31, 2-32, 2-34, 2-38, 2-42, IAT-2015L, IAT-2015R, IAT-3076AS, IAT-3076BS, IAT-3076D, IAT-3076DS, IAT-3076L, IAT-3076LA, IAT-3076R, IAT-3076RA, IBB-2015L, IBB-2015R, IBB-2042-SS, IBB-2042SS-1, IBB-2042-SS3, IG-2671F, IGH-3076, IGW-3139, 2098058, 3420600	
	B4003-039	\$18.75
	Cap Replaces: #IBN-1003, 3-8, 3-35	
	B4004-028	\$6.25
	Rotor Replaces: #1658535, 41059, 3926326, 980892, R103003, IBK1016, 4-7	

*For 12-Volt Ignition Coils & Accessories, see p.44

Dodge 8 Cylinder 1959 (with Dual Points)		
	B4001-034	\$9.00
	Points Replaces: #IAZ-2040L, IAZ-2040LS (1-43), IGP-3028YS (1-18), IGW-3028HS (1-24, 1-42), IGW-3028NS, IGW-3028PS (1-30)	
B4002-002		\$4.75
	Condenser Replaces: #2-23, 2-31, 2-32, 2-34, 2-38, 2-42, IAT-2015L, IAT-2015R, IAT-3076AS, IAT-3076BS, IAT-3076D, IAT-3076DS, IAT-3076L, IAT-3076LA, IAT-3076R, IAT-3076RA, IBB-2015L, IBB-2015R, IBB-2042-SS, IBB-2042SS-1, IBB-2042-SS3, IG-2671F, IGH-3076, IGW-3139, 2098058, 3420600	
	B4003-039	\$18.75
	Cap Replaces: #IBN-1003, 3-8, 3-35	
	B4004-028	\$6.25
	Rotor Replaces: #1658535, 41059, 3926326, 980892, R103003, IBK1016, 4-7	

*For 12-Volt Ignition Coils & Accessories, see p.44

Dodge 8 Cylinder 1960 Dart "B" Engine		
	B4001-008	\$4.75
	Points Replaces: #IBP-2040R, IBP-3028AS, 1-32, 1-46	
B4002-002		\$4.75
	Condenser Replaces: #2-23, 2-31, 2-32, 2-34, 2-38, 2-42, IAT-2015L, IAT-2015R, IAT-3076AS, IAT-3076BS, IAT-3076D, IAT-3076DS, IAT-3076L, IAT-3076LA, IAT-3076R, IAT-3076RA, IBB-2015L, IBB-2015R, IBB-2042-SS, IBB-2042SS-1, IBB-2042-SS3, IG-2671F, IGH-3076, IGW-3139, 2098058, 3420600	
	B4003-043	\$19.00
	Cap Replaces: #IBN-1003C, IBN-1003F, 3-114	
	B4004-028	\$6.25
	Rotor Replaces: #1658535, 41059, 3926326, 980892, R103003, IBK1016, 4-7	

*For 12-Volt Ignition Coils & Accessories, see p.44

Dodge 8 Cylinder 1960 Dart "A" Engine, 1960-1961 (with Single Points)		
	B4001-017	\$6.50
	Points Replaces: #IBP-2040L, IBP-3028BS, 1-33, 1-47V, 1-48	
B4002-002		\$4.75
	Condenser Replaces: #2-23, 2-31, 2-32, 2-34, 2-38, 2-42, IAT-2015L, IAT-2015R, IAT-3076AS, IAT-3076BS, IAT-3076D, IAT-3076DS, IAT-3076L, IAT-3076LA, IAT-3076R, IAT-3076RA, IBB-2015L, IBB-2015R, IBB-2042-SS, IBB-2042SS-1, IBB-2042-SS3, IG-2671F, IGH-3076, IGW-3139, 2098058, 3420600	
	B4003-043	\$19.00
	Cap Replaces: #IBN-1003C, IBN-1003F, 3-114	
	B4004-028	\$6.25
	Rotor Replaces: #1658535, 41059, 3926326, 980892, R103003, IBK1016, 4-7	

*For 12-Volt Ignition Coils & Accessories, see p.44

Dodge 8 Cylinder 1960-1961 (with Dual Points), 1962-1971 [361, 383, 413, 426, 440 (with Dual Points)]		
	B4001-034	\$9.00
	Points Replaces: #IAZ-2040L, IAZ-2040LS (1-43), IGP-3028YS (1-18), IGW-3028HS (1-24, 1-42), IGW-3028NS, IGW-3028PS (1-30)	
B4002-002		\$4.75
	Condenser Replaces: #2-23, 2-31, 2-32, 2-34, 2-38, 2-42, IAT-2015L, IAT-2015R, IAT-3076AS, IAT-3076BS, IAT-3076D, IAT-3076DS, IAT-3076L, IAT-3076LA, IAT-3076R, IAT-3076RA, IBB-2015L, IBB-2015R, IBB-2042-SS, IBB-2042SS-1, IBB-2042-SS3, IG-2671F, IGH-3076, IGW-3139, 2098058, 3420600	
	B4003-043	\$19.00
	Cap Replaces: #IBN-1003C, IBN-1003F, 3-114	
	B4004-028	\$6.25
	Rotor Replaces: #1658535, 41059, 3926326, 980892, R103003, IBK1016, 4-7	

*For 12-Volt Ignition Coils & Accessories, see p.44



Dodge 8 Cylinder 1962-1969 with Single Points		
	B4001-025	\$6.50
	Points Replaces: #2098244	
B4002-002		\$4.75
	Condenser Replaces: #2-23, 2-31, 2-32, 2-34, 2-38, 2-42, IAT-2015L, IAT-2015R, IAT-3076AS, IAT-3076BS, IAT-3076D, IAT-3076DS, IAT-3076L, IAT-3076LA, IAT-3076R, IAT-3076RA, IBB-2015L, IBB-2015R, IBB-2042-SS, IBB-2042SS-1, IBB-2042-SS3, IG-2671F, IGH-3076, IGW-3139, 2098058, 3420600	
	B4003-044	\$10.75
	Cap Replaces: #1838514	
	B4004-029	\$5.75
	Rotor Replaces: #4-1C, 4-16, 297981, 1394885, 1838516, 2098770, 2716867, 3874401, 4106104, 12309507, 312769607, C401, C401Z, C403, C411, CH308, CH310, CH312, CH317, CH403, DRC303, DRC329, XA921	

*For 12-Volt Ignition Coils & Accessories, see p.44

Dodge 8 Cylinder 1964-1969 273, 318, 340 (with Dual Points)		
	B4001-023	\$19.75
	Points *2 Required- Each Sold Separately* Replaces: #IAZ-2040RS, 1-19, 1-26, 1-41, IAZ-2040RS, IGP-3028ZS, IGW-3028KS	
B4002-002		\$4.75
	Condenser Replaces: #2-23, 2-31, 2-32, 2-34, 2-38, 2-42, IAT-2015L, IAT-2015R, IAT-3076AS, IAT-3076BS, IAT-3076D, IAT-3076DS, IAT-3076L, IAT-3076LA, IAT-3076R, IAT-3076RA, IBB-2015L, IBB-2015R, IBB-2042-SS, IBB-2042SS-1, IBB-2042-SS3, IG-2671F, IGH-3076, IGW-3139, 2098058, 3420600	
	B4003-043	\$19.00
	Cap Replaces: #IBN-1003C, IBN-1003F, 3-114	
	B4004-028	\$6.25
	Rotor Replaces: #1658535, 41059, 3926326, 980892, R103003, IBK1016, 4-7	

*For 12-Volt Ignition Coils & Accessories, see p.44

Dodge 4 Cylinder 1980-1985 w/ 1.7, 2.2 Ltr.		
	B4003-072	\$16.00
	Cap Replaces: #5206918, 5213034	

Dodge 6 Cylinder 1980-1983, 225, 3.7L Eng.		
	B4003-071	\$10.50
	Cap Replaces: #4176030	
	B4004-029	\$5.75
	Rotor Replaces: #4-1C, 4-16, 297981, 1394885, 1838516, 2098770, 2716867, 3874401, 4106104, 12309507, 312769607, C401, C401Z, C403, C411, CH308, CH310, CH312, CH317, CH403, DRC303, DRC329, XA921	



*For Ignition Coils & Accessories, see p.44

ELECTRONIC IGNITION CONVERSION KITS

Replaces Points & Condenser



Dodge 4 Cyl. 1919-1926

with North East Electric Distributor

B9600-220	12 Volt Negative Ground	\$220.95
B9600-220P12	12 Volt Positive Ground	\$237.45

Dodge 6 Cyl. 1927-1932

with North East Electric Distributor

B9600-221	12 Volt Negative Ground	\$237.45
B9600-221P6	6 Volt Positive Ground	\$250.95

Dodge 6 Cylinder 1930-1932

with Delco Distributor

B9600-309	12 Volt Negative Ground	\$154.95
B9600-309P6	6 Volt Negative Ground	\$169.45

Dodge 6 Cyl. 1933-1934

with Delco Distributor

B9600-255LS	12 Volt Negative Ground	\$162.45
B9600-255LSP12	12 Volt Positive Ground	\$175.45
B9600-255LSP6	6 Volt Positive Ground	\$175.45

*See also B9600-307LS & B9600-307LSP6 for Dodge Cars with Autolite IGS Distributors.

Dodge 6 Cyl. 1960-1972 all

B9600-040A	12 Volt Negative Ground	\$134.45
-------------------	-------------------------	-----------------

Dodge 8 Cyl. 1960-1972 All

with Single Point Distributor

B9600-042A	12 Volt Negative Ground	\$118.95
-------------------	-------------------------	-----------------

Dodge 8 Cyl. 1959-1971

with Dual Point Distributor (Except 340 Six Pack)

B9600-043	12 Volt Negative Ground	\$92.99
------------------	-------------------------	----------------

Dodge 8 Cyl. 1968-1973 340 Six Pack

B9600-044	12 Volt Negative Ground	\$139.95
------------------	-------------------------	-----------------

CUTOUT RELAYS & VOLTAGE REGULATORS

Note: Due to modern battery design, voltage regulators can't be used to charge low or dead batteries. Doing so will destroy the voltage regulator and void the warranty.

B8001-001	6-Volt Cutout Relay	\$19.50
------------------	----------------------------	----------------



15 Amps, 6 Volt Works Positive or Negative Ground

Replaces: **Autolite** - CB4014, C4012(9-5), C4012(9-4), C4012(9-1), R40061

Delco - #266P, 266N, 265P, 265N, 5015850, 812970, 265J, 820845, 812971, 1116816, 265G, 265H, 1116755, 1116751,

1116809DR, 265B, 1842859, 265C, 1867781, 265F, 265D Fits: **Dodge** - 6, 8 Cyl. All 1928-1933

B8001-002	Electronic Cutout Relay	\$19.50
------------------	--------------------------------	----------------



25 Amp, Works with 6, 12, or 24 Volts. & Positive or Negative Ground

Replaces:

Autolite - #CB4014, C4012(9-5), C4012(9-4), C4012(9-1), R40061

Delco - #266P, 266N, 265P, 265N, 5015850, 812970, 265J, 820845, 812971,

1116816, 265G, 265H, 1116755, 1116751, 1116809DR, 265B, 1842859, 265C, 1867781, 265F, 265D Fits: **Dodge** - 6, 8 Cyl. All 1928-1933

B8002-028	6-Volt Autolite Type Voltage Regulator	\$158.60
------------------	---	-----------------



6 Volt, 3 Terminal, Flat Mounting Bracket Regulator (Premium Quality Made in the USA)

Replaces:

Prestolite - 8-117, 8-70, 8-74, GRX-761, VBE-6102A, VBE-6104A, VBO-4601F, VBO-4601K, VBO-4602B, VBO-4602R,

VRB-4002C, VRP-4001A, VRP-4001B, VRP-4002D, VRP-4003A, VRP-4003B, VRP-4004A, VRP-4004C, VRP-4004F, VRP-4008A, VRP-6001A, VRP-6001B, VRP-6002A, VRP-6005A, VRP-6101A, VRP-6101B **Chrysler** - 1120515, 1121978, 1257394, 1321757, 1343573, 1571161, 2095209, 871763

Fits: **Dodge** - 1939 to 1942 All, & 1946-1955, GDZ Generator

B8002-031	6-Volt Autolite Type Voltage Regulator	\$144.88
------------------	---	-----------------



6 Volt, 3 Terminal, Flat Mounting Bracket Regulator. Positive Ground. (Premium Quality Made in the USA)

Replaces:

Chrysler - #1311467, 1343753, 1502074, 1641510



Delco - #A602, A602M

Prestolite - #8-76, 8-762, VBE-6001A, VBE-6101, VBE-6201A, VBO-4602E, VBO-4602V

Fits: **Dodge** - 6 Cyl. 1950-1956 (All with GGW Generator), 8 Cyl. 1950-1956 (All with GGW Generator)

B8002-008	12-Volt Autolite Type Voltage Regulator	\$69.75
	12 Volt, 3 Terminal, Flat Mounting (Premium Quality, Made in the USA) Replaces: Prestolite - #8-154, 8-414, 8-58, 8-59, 8-722, 8-85, GRX-722, VBO-4201E, VBO-4202A, VBO-4202B, VBO-4202P, VBO-4202R, VR-6301A, VRX-6010, VRX-6010A Chrysler - #1642333, 1842798, 1889944, 2095341, 2095531 Delco - #1972029, 1972061, A600, A600M, A605, A605M Fits: Dodge - 1956-1960 (Except GGA Generator)	

SWITCHES

B5006-004	Starter Switch	\$11.75
	6 or 12 Volt Starter Mounted Manual Push Button Starter Switch Fits: Dodge Car - 1930-1934	
B5007-007	6 Volt Internal Ground Solenoid	\$17.50
	Has a Flat Bracket & 3-Terminal Post. Works with 6-Volt Systems. Replaces: Autolite - #SST-4006 (15-29), SST-4007 (15-30) Fits: Dodge Car - 1949-1954	
B5010-018	Turn Signal Light Switch	\$73.50
	Universal Turn Signal Switch. Has right turn, left turn, and warning flasher modes. Metal Construction with Color Coded Wire Leads. Fuse, clamp ring, and instruction sheet included. Fits: Pre-1953 Vehicles	

IDENTIFICATION TAGS





B9013-001	Small Autolite I.D. Tag (Blank)	\$7.00
	Small Autolite I.D. Tag (Stamped)	\$14.25
	2 5/16" Long, Black I.D. Tag for Distributors, Starters, & Generators with Rivets	
B9013-002	Large Autolite I.D. Tag (Blank)	\$7.00
	Large Autolite I.D. Tag (Stamped)	\$14.25
	2 15/16" Long, Black I.D. Tag for Distributors, Starters, & Generators with Rivets	



ALTERNATORS

B6001-001	12 Volt Alternator (1 Wire)	\$112.75
63 Amp, Low Cut In, Specially Built For Tractors, Forklifts, & Other Low Engine Speed Applications		
B6001-002	12 Volt Alternator (1 Wire/ 3 Wire)	\$118.75
63 Amp, With 1 Wire Or 3 Wire For Warning Lamp On Automobiles & Trucks		
B6001-005	6 Volt Alternator (1 Wire, Positive Ground)	\$166.50
6 Volt, 40 Amp Alternator with Positive Ground, 1 Wire, 3/8" pulley		

CARBURETOR REBUILD KITS

B9022-019	Carter Carburetor Rebuild Kit	\$39.75
	Chrysler (Dodge) Engine Model 230", 251", 265" Fits Carburetor: Carter Carburetor: #E7R1	
B9022-008	Zenith Carburetor Rebuild Kit	\$26.95
	Chrysler (Dodge) Engine Model 32, T112, T125, 1.6 Liter Fits Carburetor: Zenith Carburetor: #9698, 13004, 13851, 14544 Chrysler Carburetor: #4142128	
B9022-009	Zenith Carburetor Rebuild Kit	\$27.99
	Chrysler (Dodge) Engine Model 32, T78, 218", 318" Fits Carburetor: Zenith Carburetor: #10608, 10608A, 10608B, 10608C, 10888, 11483, 11885, 11885A, 11885B, 11622, 11644, S496, S496A Chrysler Carburetor: #995200, 1140252, 1316376, 1533324, 1551519	
B9022-011	Zenith Carburetor Rebuild Kit	\$24.99
	Chrysler (Dodge) Engine Model 30 Fits: Zenith Carburetor: #12730, 12731, 14992 Chrysler Carburetor: #2125827, 21258856	

DODGE TRUCK

TABLE OF CONTENTS

Spark Plug Wire Sets	462
Battery Cables, Wire Harnesses	462
Tune Up Parts	463
Electronic Ignition Conversion Kits	466
Voltage Regulators	466
Starter Switches & Solenoids	467
Identification Tags	467
Switches	467
Alternators	467
Carburetor Rebuild Kits	467

SPARK PLUG WIRE SETS

Our Spark Plug Wire Sets Come Fully Assembled with the Proper Type Wire & Terminals.

They are Custom Tailored to Look & Fit Like Original Factory Equipment.

Varieties include:

PVC Wire: Copper Core with a Rubber Jacket.

EPDM Wire (E): Hi Performance Premium Conductor with a Tinned Copper Core, EPDM Insulation, Rubber Jacket.

Suppression Wire (S): for Electronic Ignition and is Spiral Wound, Low-Ohm, with EPDM Silicone Insulation and a Rubber Jacket.



BATTERY CABLES



Our Battery Cables are made from the Proper Gauge Copper, as either Black Cotton Braided Wire or PVC Wire (whichever is correct for the application), using Soldered & Heat Sealed Brass or Copper Terminals.

Dodge Truck 1941-1947

B2065-001	Positive Battery Cable	\$34.50
B2065-002	Negative Battery Cable	\$34.75

Dodge Truck 1965-1971 (with 413, 383, & 361 CID Engines)

8 Cyl. Tailored Spark Plug Wire Set

B1065-001	Original Type PVC Wire	\$67.50
B1065-001E	EPDM Wire	\$81.00
B1065-001S	Suppression Wire	\$81.00

WIRING HARNESSSES



Our Wire Harnesses are made with our premium cotton braid and/or PVC wire.

They have the correct gauge, color, wire, & fuse holders (if needed).

All terminals are soldered according to the original.

(Harnesses do not include Battery Cables & Spark Plug Wires; however, we can supply these as separate products.)

NO HIDDEN COSTS, NOTHING EXTRA TO BUY!

Dodge Truck 1936 Model LC (with 116" Wheelbase)

B3065-017	Complete Wire Harness, Modified for a 2-Wire Generator & Regulator & Turn Signals	\$981.50
------------------	---	-----------------

Dodge Truck 1937-1938 Models MC, MD (w/ 116" Wheelbase)

(fits ME & MF when used with additional Rear Harness Extension 160" Wheelbase)

B3065-015	Complete Wire Harness, Modified for a 2-Wire Generator & Regulator & Turn Signals	\$987.75
B3065-016	Rear Harness Extension, Add-on for Models ME & MF	\$87.50

Dodge Truck 1941-1947 Models WC, WD, WF, WG, WH *Note: does not fit military applications.

Complete Wire Harness

B3065-003	Original Design with Generator & Regulator	\$718.00
B3065-008	Modified for a 1 Wire Alternator	\$718.00
B3065-011	Original Design with Generator & Regulator, Modified for Turn Signals	\$858.00
B3065-014	Modified for 1-Wire Alternator & Turn Signals	\$858.00

B3065-018	Rear Harness Extension for 126" Wheelbase for B3065-011, B3065-014 above, Modified for Turn Signals	Add-on for Models WC, WD, WE, WF, WG, WH	\$44.25
B3065-019	Rear Harness Extension for 133" Wheelbase for B3065-011, B3065-014 above, Modified for Turn Signals	Add-on for Models WC, WD, WE, WF, WG, WH	\$46.25

Includes Listed Components Below and Can Be Purchased Separately

Engine & Dash Harness

B3065-001	Original Design with Generator & Regulator	\$461.50
B3065-007	Modified for a 1-Wire Alternator	\$461.50
B3065-012	Original Design with Generator & Regulator, Modified for Turn Signals	\$601.50
B3065-002	Body to Headlamp Connect Harness, Original Design	\$296.75
B3065-013	Body to Headlamp Connect Harness, Modified for Turn Signals	\$353.25

Dodge Truck 1946-1950 Model WDX (Power Wagon)

Complete Wire Harness

B3065-006	Original Design	\$748.75
B3065-025	Original Design, Modified for Turn Signals	\$889.00
B3065-026	Modified for 1-Wire Alternator & Turn Signals	\$889.00

Dodge Truck 1948-1953

All B series (Except Cab Over Engine- COE & Powerwagon), 108" Wheelbase

Complete Wire Harness

B3065-004	Original Design with Generator & Regulator	\$735.50
B3065-009	Original Design with Generator & Regulator, Modified for Turn Signals	\$875.50
B3065-028	Modified for 1-Wire Alternator & Turn Signals	\$875.50
B3065-010	Rear Harness Extension for 127" Wheelbase, Modified for Turn Signals	\$46.25
B3065-022	Rear Harness Extension for 116" Wheelbase, Modified for Turn Signals	\$43.25

Dodge Truck 1953-1954 (Cab Over Engine) Model #B3HM, B4HM

B3065-005	Complete Wire Harness	\$570.50
------------------	------------------------------	-----------------

Dodge Conventional Truck 1954-1956 Model C1B6 with Straight 6 Engine

Complete Wire Harness



B3065-023	Original Design	\$757.00
B3065-024	Modified for Turn Signals	\$897.25



Dodge Conventional Truck 1954-1956 Models C1D8, C2D8, C3D8 with V8 Engine & 116" Wheelbase

Complete Wire Harness

B3065-021	Original Design	\$757.00
B3065-020	Modified for Turn Signals	\$897.25
B3065-027	Modified for a 1-Wire Alternator & Turn Signals	\$897.25

TUNE UP PARTS



<u>Dodge Truck</u> 6 Cylinder 1930-1932 (with Delco Distributor)		
	B4001-021 Points Replaces: #1855520, D-109	\$13.75
	B4002-001 Condenser Replaces: #1928111, D-203, 1869704, D-200	\$4.75



	B4004-021 Rotor Replaces: #816774	\$14.75
	B4003-059 Cap Replaces: #816779, 822465, 1831800, 1853240	\$22.50

***For 6-Volt Ignition Coils & Accessories, see p.44**





Dodge Truck 6 Cylinder 1933-1934		
	B4100-001	\$10.50
	PCR Kit Includes: Points (#B4001-001), Condenser (#B4002-001), Rotor (#B4004-002) Replaces: Points - #D100HP, 1855720 Condenser - #1928111, D-203, 1869704, D-200 Rotor - #820445, D400	
	B4004-002	\$5.75
	Rotor Replaces: #820445, D400	
	B4003-002	\$20.25
	Distributor Cap Premium Grade, Made in the USA (Brass Contacts) Replaces: #824735, D301	
	B4007-001	\$11.95
	Cap Clip Short Mount, 1 Used Replaces: #1889967, 1847289, 453844, 453461	
	B4007-002	\$11.95
	Cap Clip Long Mount, 1 Used Replaces: #1889967, 1889999, 453844, 453461	
	B4008-001	\$14.99
	Distributor Insulator Replaces: #1904376	
	B4009-001	\$25.99
	Distributor Bushing & Shim Kit	
B4006-001	Dust Cover	Replaces: #1900119 \$9.99

*For 6-Volt Ignition Coils & Accessories, see p.44



Dodge Truck 6 Cylinder 1935-1938 (All IGC, IGS Distributor)		
	B4001-002	\$14.75
	Points Replaces: #IGW-3028S, 1-31	
	B4002-006	\$7.50
	Condenser Replaces: #2-31, 2-38, 2-42, 2-95, IAT-1125S, IAT-3076BS, IBB-2042SS-1, IBB-2042-SS3, IG-3927F, IG-3927G, IG-3927K, IG-3927R	



	B4004-002	\$5.75
	Rotor Replaces: #820445, D400	
	B4003-007	\$25.00
	Distributor Cap Premium Grade, Made in the USA (Brass Contacts) Replaces: #IGC-1107S, 3-23	

*For 6-Volt Ignition Coils & Accessories, see p.44



Dodge Truck 6 Cylinder 1939-1941 (With IAD, IGC Distributors), 1942-1947 All (Including Chrysler # 957376, IGS-4203A Distributor)		
	B4001-005	\$9.75
	Points Replaces: #1-4, 1-8, 1-9, 1-20, 1-22, 1-45, IAD-3128S, IGP-3028ES, IGP3028FS, IGS2224L, IGW3028AS	
	B4002-006	\$7.50
	Condenser Replaces: #2-31, 2-38, 2-42, 2-95, IAT-1125S, IAT-3076BS, IBB-2042SS-1, IBB-2042-SS3, IG-3927F, IG-3927G, IG-3927K, IG-3927R	
	B4004-007	\$8.25
	Rotor Premium Grade, Made in the USA Replaces: #4-19	
	B4003-007	\$25.00
	Distributor Cap Premium Grade, Made in the USA (Brass Contacts) Replaces: #IGC-1107S, 3-23	

*For 6-Volt Ignition Coils & Accessories, see p.44

Dodge Truck 6 Cylinder 1948-1950 B1 Series		
	B4001-005	\$9.75
	Points Replaces: #1-4, 1-8, 1-9, 1-20, 1-22, 1-45, IAD-3128S, IGP-3028ES, IGP3028FS, IGS2224L, IGW3028AS	
	B4002-002	\$4.75
	Condenser Replaces: #2-23, 2-31, 2-32, 2-34, 2-38, 2-42, IAT-2015L, IAT-2015R, IAT-3076AS, IAT-3076BS, IAT-3076D, IAT-3076DS, IAT-3076L, IAT-3076LA, IAT-3076R, IAT-3076RA, IBB-2015L, IBB-2015R, IBB-2042-SS, IBB-2042SS-1, IBB-2042-SS3, IG-2671F, IGH-3076, IGW-3139, 2098058, 3420600	

	B4003-035	\$31.50
	Cap Replaces: #IAO-1003, 3-1	
	B4004-007	\$8.25
	Rotor Premium Grade, Made in the USA Replaces: #4-19	



*For 6-Volt Ignition Coils & Accessories, see p.44

	B4003-035	\$31.50
	Cap Replaces: #IAO-1003, 3-1	
	B4004-007	\$8.25
	Rotor Premium Grade, Made in the USA Replaces: #4-19	

*For 6- or 12-Volt Ignition Coils & Accessories, see p.44



Dodge Truck 6 Cylinder 1949-1958 (Except IAO, IAP, IAY, Distributors), 1959 (All Except M6-D100-300, W100, 200)		
	B4001-022	\$16.75
	Points Replaces: #IGS-2224, 1-44, 2084075	
B4002-002		\$4.75
	Condenser Replaces: #2-23, 2-31, 2-32, 2-34, 2-38, 2-42, IAT-2015L, IAT-2015R, IAT-3076AS, IAT-3076BS, IAT-3076D, IAT-3076DS, IAT-3076L, IAT-3076LA, IAT-3076R, IAT-3076RA, IBB-2015L, IBB-2015R, IBB-2042-SS, IBB-2042SS-1, IBB-2042-SS3, IG-2671F, IGH-3076, IGW-3139, 2098058, 3420600	
	B4003-036	\$13.50
	Cap Replaces: #IAT-1033, IAT-1033A, IAT-1033C, 3-4, 3-34, 3-37	
	B4004-026	\$6.75
	Rotor Replaces: #IAU-1016A, 4-4	

*For 6- or 12-Volt Ignition Coils & Accessories, see p.44

Dodge Truck 6 Cylinder 1949-1958 (With Chrysler # 1193282, Autolite # IAO-4102-1, IAP, IAY, Distributors)		
	B4001-005	\$9.75
	Points Replaces: #1-4, 1-8, 1-9, 1-20, 1-22, 1-45, IAD-3128S, IGP-3028ES, IGP3028FS, IGS2224L, IGW3028AS	
B4002-002		\$4.75
	Condenser Replaces: #2-23, 2-31, 2-32, 2-34, 2-38, 2-42, IAT-2015L, IAT-2015R, IAT-3076AS, IAT-3076BS, IAT-3076D, IAT-3076DS, IAT-3076L, IAT-3076LA, IAT-3076R, IAT-3076RA, IBB-2015L, IBB-2015R, IBB-2042-SS, IBB-2042SS-1, IBB-2042-SS3, IG-2671F, IGH-3076, IGW-3139, 2098058, 3420600	

Dodge Truck 6 Cylinder 1960 (Except P6-W300M)		
	B4001-005	\$9.75
	Points Replaces: #1-4, 1-8, 1-9, 1-20, 1-22, 1-45, IAD-3128S, IGP-3028ES, IGP3028FS, IGS2224L, IGW3028AS	
B4002-006		\$7.50
	Condenser Replaces: #2-31, 2-38, 2-42, 2-95, IAT-1125S, IAT-3076BS, IBB-2042SS-1, IBB-2042-SS3, IG-3927F, IG-3927G, IG-3927K, IG-3927R	
	B4003-036	\$13.50
	Cap Replaces: #IAT-1033, IAT-1033A, IAT-1033C, 3-4, 3-34, 3-37	
	B4004-026	\$6.75
	Rotor Replaces: #IAU-1016A, 4-4	



*For 12-Volt Ignition Coils & Accessories, see p.44

Dodge Truck 6 Cylinder 1960-1961 (Except Canada Models)		
	B4001-025	\$6.50
	Points Replaces: #2098244	
B4002-002		\$4.75
	Condenser Replaces: #2-23, 2-31, 2-32, 2-34, 2-38, 2-42, IAT-2015L, IAT-2015R, IAT-3076AS, IAT-3076BS, IAT-3076D, IAT-3076DS, IAT-3076L, IAT-3076LA, IAT-3076R, IAT-3076RA, IBB-2015L, IBB-2015R, IBB-2042-SS, IBB-2042SS-1, IBB-2042-SS3, IG-2671F, IGH-3076, IGW-3139, 2098058, 3420600	
	B4004-029	\$5.75
	Rotor Replaces: #4-1C, 4-16, 297981, 1394885, 1838516, 2098770, 2716867, 3874401, 4106104, 12309507, 312769607, C401, C401Z, C403, C411, CH308, CH310, CH312, CH317, CH403, DRC303, DRC329, XA921	

*For 12-Volt Ignition Coils & Accessories, see p.44

Dodge Truck 6 Cylinder 1962-1969 (with Chrysler Distributor)		
	B4001-025	\$6.50
	Points Replaces: #2098244	
B4002-002		\$4.75
	Condenser Replaces: #2-23, 2-31, 2-32, 2-34, 2-38, 2-42, IAT-2015L, IAT-2015R, IAT-3076AS, IAT-3076BS, IAT-3076D, IAT-3076DS, IAT-3076L, IAT-3076LA, IAT-3076R, IAT-3076RA, IBB-2015L, IBB-2015R, IBB-2042-SS, IBB-2042SS-1, IBB-2042-SS3, IG-2671F, IGH-3076, IGW-3139, 2098058, 3420600	
	B4003-042	
	Cap Replaces: #2098765, 1889424	
	B4004-029	
	Rotor Replaces: #4-1C, 4-16, 297981, 1394885, 1838516, 2098770, 2716867, 3874401, 4106104, 12309507, 312769607, C401, C401Z, C403, C411, CH308, CH310, CH312, CH317, CH403, DRC303, DRC329, XA921	

*For 12-Volt Ignition Coils & Accessories, see p.44

Dodge Truck 6 Cylinder 1980-1987, 225, 3.7L Eng.		
	B4003-071	\$10.50
	Cap Replaces: #4176030	
	B4004-029	
	Rotor Replaces: #4-1C, 4-16, 297981, 1394885, 1838516, 2098770, 2716867, 3874401, 4106104, 12309507, 312769607, C401, C401Z, C403, C411, CH308, CH310, CH312, CH317, CH403, DRC303, DRC329, XA921	



*For Ignition Coils & Accessories, see p.44

ELECTRONIC IGNITION CONVERSION KITS

Replaces Points & Condenser



Dodge Truck 4 Cyl. 1930-1932

with Delco #629A, 629E Distributor

B9600-311	12 Volt Negative Ground	\$154.95
B9600-311P6	6 Volt Positive Ground	\$165.45

Dodge Truck 6 Cyl. 1930-1932

with Delco Distributor

B9600-309	12 Volt Negative Ground	\$154.95
B9600-309P6	6 Volt Positive Ground	\$169.45

Dodge Truck 6 Cyl. 1933-1934

B9600-255LS	12 Volt Negative Ground	\$162.45
B9600-255LSP12	12 Volt Positive Ground	\$175.45
B9600-255LSP6	6 Volt Positive Ground	\$175.45

Dodge Truck

6 Cyl. 1939-1941 with IAD, IGC Distributors

1942-1947 All Including Chrysler #957376, IGS-4203A Distributors

B9600-307LS	12 Volt Negative Ground	\$169.45
B9600-307LSP6	6 Volt Positive Ground	\$185.95

Dodge Truck 6 Cyl. 1948-1950 B1 Series,

1949-1958 with Chrysler #1193282, Autolite #IAO-4102-1 Distributors

B9600-070A	12 Volt Negative Ground	\$195.95
-------------------	-------------------------	-----------------

VOLTAGE REGULATORS

Note: Due to modern battery design, voltage regulators can't be used to charge low or dead batteries. Doing so will destroy the voltage regulator and void the warranty.

B8002-028	6-Volt Autolite Type Voltage Regulator	\$158.60
------------------	---	-----------------



6 Volt, 3 Terminal, Flat Mounting Bracket Regulator (Premium Quality/ USA Made)
Replaces: **Prestolite** - #8-117, 8-70, 8-74, GRX-761, VBE-6102A, VBE-6104A, VBO-4601F, VBO-4601K, VBO-4602B, VBO-4602R, VRB-4002C, VRP-4001A, VRP-4001B, VRP-4002D, VRP-4003A, VRP-4003B, VRP-4004A, VRP-4004C, VRP-4004F, VRP-4008A, VRP-6001A, VRP-6001B, VRP-6002A, VRP-6005A, VRP-6101A, VRP-6101B **Chrysler** - #1120515, 1121978, 1257394, 1321757, 1343573, 1571161, 2095209, 871763
Fits: **Dodge Truck** - 1942 to 1947

B8002-008	12-Volt Autolite Type Voltage Regulator	\$69.75
	12 Volt, 3 Terminal, Flat Mounting (Premium Quality, Made in the USA) Replaces: Prestolite - #8-154, 8-414, 8-58, 8-59, 8-722, 8-85, GRX-722, VBO-4201E, VBO-4202A, VBO-4202B, VBO-4202P, VBO-4202R, VR-6301A, VRX-6010, VRX-6010A Chrysler - #1642333, 1842798, 1889944, 2095341, 2095531 Delco - #1972029, 1972061, A600, A600M, A605, A605M Fits: Dodge Truck - 1956-1963 (Except GGA Generator)	

ALTERNATORS

Delco 10SI Type

	B6001-001	12 Volt Alternator (1 Wire)	\$112.75
63 Amp, Low Cut In, Specially Built For Tractors, Forklifts, & Other Low Engine Speed Applications			
B6001-002	12 Volt Alternator (1 Wire/ 3 Wire)		\$118.75
63 Amp, With 1 Wire Or 3 Wire For Warning Lamp On Automobiles & Trucks			
B6001-005	6 Volt Alternator (1 Wire, Positive Ground)		\$166.50
6 Volt, 40 Amp Alternator with Positive Ground, 1 Wire, 3/8" pulley			

STARTER SWITCHES & SOLENOIDS

B5007-007	6 Volt Internal Ground Solenoid	\$17.50
	Has a Flat Bracket & 3 Terminal Post. Works with 6 Volt Systems. Replaces: Autolite - #SST-4006 (15-29), SST-4007 (15-30) Fits: Dodge Truck - 8 Cyl. 1953-1955	

CARB. REBUILD KITS

B9022-019	Carter Carburetor Rebuild Kit	\$39.75
	Chrysler (Dodge) Engine Model 230", 251", 265" Fits: Carter Carburetor: #E7R1	

IDENTIFICATION TAGS

	B9013-001	Small Autolite I.D. Tag (Blank)	\$7.00
		Small Autolite I.D. Tag (Stamped)	\$14.25
		2 5/16" Long, Black I.D. Tag for Distributors, Starters, & Generators with Rivets	
	B9013-002	Large Autolite I.D. Tag (Blank)	\$7.00
		Large Autolite I.D. Tag (Stamped)	\$14.25
		2 15/16" Long, Black I.D. Tag for Distributors, Starters, & Generators with Rivets	

B9022-008	Zenith Carburetor Rebuild Kit	\$26.95
	Chrysler (Dodge) Engine Model 32, T112, T125, 1.6 Liter Fits: Zenith Carburetor: #9698, 13004, 13851, 14544 Chrysler Carburetor: #4142128	

SWITCHES

B5010-018	Turn Signal Light Switch	\$73.50
	Universal Turn Signal Switch. Has right turn, left turn, and warning flasher modes. Metal Construction with Color Coded Wire Leads. Fuse, clamp ring, and instruction sheet included. Fits: Pre-1953 Vehicles	

B9022-009	Zenith Carburetor Rebuild Kit	\$27.99
	Chrysler (Dodge) Engine Model 32, T78, 218", 318" Fits: Zenith Carburetor: #10608, 10608A, 10608B, 10608C, 10888, 11483, 11885, 11885A, 11885B, 11622, 11644, S496, S496A Chrysler Carburetor: #995200, 1140252, 1316376, 1533324, 1551519	

B9022-011	Zenith Carburetor Rebuild Kit	\$24.99
	Chrysler (Dodge) Engine Model 30 Fits: Zenith Carburetor: #12730, 12731, 14992 Chrysler Carburetor: #2125827, 21258856	

DORRIS

BATTERY CABLES



Our Battery Cables are made from the Proper Gauge Copper, as either **Black Cotton Braided Wire** or **PVC Wire** (whichever is correct for the application), using Soldered & Heat Sealed Brass or Copper Terminals.

Dorris 1916

B2066-001	Positive Battery Cable	\$44.50
B2066-002	Negative Battery Cable	\$33.00

Dorris 1918

B2066-003	Positive Battery Cable	\$31.50
B2066-004	Negative Battery Cable	\$34.50
B2066-005	Switch to Starter Cable	\$44.75

SPARK PLUG WIRE SETS

Our Spark Plug Wire Sets Come Fully Assembled with the Proper Type Wire & Terminals.

They are Custom Tailored to Look & Fit Like Original Factory Equipment.

Varieties include:

Cotton Braid Wire: Copper Core with a Cotton Jacket.

EPDM Wire (E): Hi Performance Premium Conductor with a Tinned Copper Core, EPDM Insulation, Rubber Jacket.



DURANT

Durant 1926

6 Cyl. Tailored Spark Plug Wire Set

B1067-001	Original Type Cotton Braid Wire	\$50.75
B1067-001E	EPDM Wire	\$55.50

ESSEX

Essex 1924

6 Cyl. Tailored Spark Plug Wire Set

B1068-002	Original Type Cotton Braid Wire	\$50.75
B1068-002E	EPDM Wire	\$55.50

Essex 1926

6 Cyl. Tailored Spark Plug Wire Set

B1068-001	Original Type Cotton Braid Wire	\$50.75
B1068-001E	EPDM Wire	\$55.50

FEDERAL TRUCK

SPARK PLUG WIRE SETS

Federal Truck 1917

1 ½ Ton Continental Engine
4 Cyl. Tailored Spark Plug Wire Set

B1069-003	Original Type Cotton Braid Wire	\$43.50
B1069-003E	EPDM Wire	\$47.50

Federal Truck 1938-1953

6 Cyl. Tailored Spark Plug Wire Set
with Hercules JXB Engine

B1069-001	Original Type Cotton Braid Wire	\$62.50
B1069-001E	EPDM Wire	\$68.25
B1069-001S	Suppression Wire	\$68.25
B1069-001CS	Cotton Suppression Wire	\$108.00

with Hercules JXLD Engine

B1069-004	Original Type Cotton Braid Wire	\$62.50
B1069-004E	EPDM Wire	\$68.25

Federal Truck 1948-1953

6 Cyl. Tailored Spark Plug Wire Set
with Hercules JXEF Engine

B1069-002	Original Type Cotton Braid Wire	\$50.75
B1069-002E	EPDM Wire	\$55.50

TUNE UP PARTS

Federal Truck 6 Cylinder 1948-1953 (with Hercules C, D, E, JXB, LD, QXLD Engines & Delco Distributor #1112354)

	B4100-001	\$10.50
	PCR Kit Includes: Points (#B4001-001), Condenser (#B4002-001), Rotor (#B4004-002) Replaces: Points - #D100HP, 1855720 Condenser - #1928111, D-203, 1869704, D-200 Rotor - #820445, D400	
	B4004-002	\$5.75
Rotor Replaces: #820445, D400		
	B4003-002	\$20.25
	Distributor Cap Premium Grade, Made in the USA (Brass Contacts) Replaces: #824735, D301	
	B4006-001	\$9.99
	Dust Cover Replaces: #1900119	
	B4007-001	\$11.95
	Cap Clip Short Mount, 1 Used Replaces: #1889967, 1847289, 453844, 453461	

	B4007-002	\$11.95
	Cap Clip Long Mount, 1 Used Replaces: #1889967, 1889999, 453844, 453461	
	B4008-001	\$14.99
	Distributor Insulator Replaces: #1904376	
	B4009-001	\$25.99
	Distributor Bushing & Shim Kit	

*For 6- or 12-Volt Ignition Coils & Accessories, see p.44

Federal Truck 6 Cylinder 1947-1954 Models 3400, 4400, 4500, 5500, 6000, 6500 (All Models With Distributors #1110176, 1111774, 1111778, 1111779, 1112266)		
	B4100-002	\$10.50
	PCR Kit Includes: Points (#B4001-001), Condenser (#B4002-003), Rotor (#B4004-002) Replaces: Points - #D100HP, 1855720 Condenser - #1928111, D203 Rotor - #820445, D400	
	B4004-002	\$5.75
	Rotor Replaces: #820445, D400	
	B4003-002	\$20.25
	Distributor Cap Premium Grade, Made in the USA (Brass Contacts) Replaces: #824735, D301	
	B4006-001	\$9.99
	Dust Cover Replaces: #1900119	
	B4007-001	\$11.95
	Cap Clip Short Mount, 1 Used Replaces: #1889967, 1847289, 453844, 453461	
	B4007-002	\$11.95
	Cap Clip Long Mount, 1 Used Replaces: #1889967, 1889999, 453844, 453461	
	B4008-001	\$14.99
	Distributor Insulator Replaces: #1904376	
	B4009-001	\$25.99
	Distributor Bushing & Shim Kit	

*For 6- or 12- Volt Ignition Coils & Accessories, see p.44

ELECTRONIC IGNITION CONVERSION KITS

Federal Truck 4 Cyl. 1936-1938 with Delco 625H, 625M, 625J Distributors		
B9600-311	12 Volt Negative Ground	\$154.95
B9600-311P6	6 Volt Positive Ground	\$165.45
Federal Truck 6 Cyl. 1948-1953 with Hercules Engines C, D, E, JXB, LD, QXLD with Distributor #1110198, 1112354		
B9600-255LS	12 Volt Negative Ground	\$162.45
B9600-255LSP12	12 Volt Positive Ground	\$175.45
B9600-255LSP6	6 Volt Positive Ground	\$175.45

*For Ignition Coils & Accessories, see p.44

VOLTAGE REGULATORS

Note: Due to modern battery design, voltage regulators can't be used to charge low or dead batteries. Doing so will destroy the voltage regulator and void the warranty.

B8002-003	Delco 6-Volt Voltage Regulator	\$119.75
	6 Volt, 3 Terminal, 26-30 Amps, Positive Ground, (Premium Quality, Made in the USA) Replaces: Delco # 1118208, 1118215, 1118230, 1118234, 1118253, 1118271, 1118303, 1118350, 1118871, 1119176, 5559, 5596, 5597, 5810, 5811, 5813, 5818, 5828, 5831, 5861, 5865, 5867, 5874, D5865, D603 Fits: Federal Truck – 1948-1953: Hercules C, D, E, JXB, LD, QXLD Engine	

Light Switches

B5010-018	Turn Signal Light Switch	\$73.50
	Universal Turn Signal Switch. Has right turn, left turn, and warning flasher modes. Metal Construction with Color Coded Wire Leads. Fuse, clamp ring, and instruction sheet included. Fits: Pre-1953 Vehicles	

ALTERNATORS

B6001-001	12 Volt Alternator (1 Wire)	\$112.75
	63 Amp, Low Cut In, Specially Built For Tractors, Forklifts, & Other Low Engine Speed Applications	

FORD CAR

TABLE OF CONTENTS

Spark Plug Wire Sets _____	470
Battery Cables _____	471
Replacement Distributors, Tune Up Parts _____	471
Electronic Ignition Conversion Kits _____	475
Switches, Flashers _____	475
Voltage Regulators _____	476
Generator Bushing & Brush Sets, Alternators _____	476

SPARK PLUG WIRE SETS

Our Spark Plug Wire Sets Come Fully Assembled with the Proper Type Wire & Terminals.

They are Custom Tailored to Look & Fit Like Original Factory Equipment.

Varieties include:

Cotton Braid Wire: Copper Core with a Cotton Jacket.

PVC Wire: Copper Core with a Rubber Jacket.

EPDM Wire (E): Hi Performance Premium Conductor with a Tinned Copper Core, EPDM Insulation, Rubber Jacket.

Suppression Wire (S): for Electronic Ignition and is Spiral Wound, Low-Ohm, with EPDM Silicone Insulation and a Rubber Jacket.

Cotton Braid Suppression Wire (CS): also for Electronic Ignition, as Suppression Wire, but has an additional layer of Cotton Braid & Lacquer to replicate the vintage look, as well.



Ford Model T with Coils On Dash

4 Cyl. Tailored Spark Plug Wire Set
Up to 1920

B1070-001	Original Type Cotton Braid Wire	\$36.50
------------------	--	----------------

1921-1927

B1070-015	Original Type Cotton Braid Wire	\$28.75
------------------	--	----------------

Ford Model A

Coil Wire

B1070-002	Original Type Cotton Braid Wire	\$10.00
------------------	--	----------------

6-Cylinder

Ford 1941-1948

6 Cyl. Tailored Spark Plug Wire Set

B1070-004	Original Type Cotton Braid Wire	\$50.75
B1070-004E	EPDM Wire	\$55.50
B1070-004S	Suppression Wire	\$55.50
B1070-004CS	Cotton Suppression Wire	\$87.50

Ford 1949-1955

6 Cyl. Tailored Spark Plug Wire Set
Replaces #7HA-12259

B1070-005	Original Type PVC Wire	\$46.00
B1070-005E	EPDM Wire	\$55.50
B1070-005S	Suppression Wire	\$55.50

Ford 1965-1976 w/ 170", 200", 250" Engines

6 Cyl. Tailored Spark Plug Wire Set

B1070-013	Original Type EPDM Wire	\$55.50
B1070-013S	Suppression Wire	\$55.50

8-Cylinder

Ford 1934-1936

8 Cyl. Tailored Spark Plug Wire Set, Replaces #18-12259

B1070-010	Original Type Cotton Braid Wire	\$68.00
B1070-010E	EPDM Wire	\$74.00
B1070-010S	Suppression Wire	\$74.00
B1070-010CS	Cotton Suppression Wire	\$117.25

Ford 1937-1941

8 Cyl. Tailored Spark Plug Wire Set, Replaces #78-12259

B1070-006	Original Type Cotton Braid Wire	\$68.00
B1070-006E	EPDM Wire	\$74.00
B1070-006S	Suppression Wire	\$74.00
B1070-006CS	Cotton Suppression Wire	\$117.25

Ford 1942-1944 (Ford Cars & Trucks)

8 Cyl. Tailored Spark Plug Wire Set, Replaces #21A-12259

B1070-007	Original Type Cotton Braid Wire	\$68.00
B1070-007E	EPDM Wire	\$74.00
B1070-007S	Suppression Wire	\$74.00
B1070-007CS	Cotton Suppression Wire	\$117.25

Ford 1946-1948

8 Cyl. Tailored Spark Plug Wire Set, Replaces #59A-12259

B1070-014	Original Type Cotton Braid Wire	\$68.00
B1070-014E	EPDM Wire	\$74.00
B1070-014S	Suppression Wire	\$74.00
B1070-014CS	Cotton Suppression Wire	\$117.25

Ford 1949-1952

8 Cyl. Tailored Spark Plug Wire Set, Replaces #1A-12259

B1070-008	Original Type PVC Wire	\$61.75
B1070-008E	EPDM Wire	\$74.00
B1070-008S	Suppression Wire	\$74.00

Ford 1953

8 Cyl. Tailored Spark Plug Wire Set

B1070-009	Original Type PVC Wire	\$61.75
B1070-009E	EPDM Wire	\$74.00
B1070-009S	Suppression Wire	\$74.00

Ford 1963-1976

8 Cyl. Tailored Spark Plug Wire Set

B1070-011	Original Type PVC Wire	\$60.25
B1070-011S	Suppression Wire	\$72.50

Ford 1975-1976

with 351"M, 400" small block, 460" Engines

8 Cyl. Tailored Spark Plug Wire Set

B1070-012	Original Type PVC Wire	\$60.25
B1070-012S	Suppression Wire	\$72.50

BATTERY CABLES



Our Battery Cables are made from the Proper Gauge Copper, as either Black Cotton Braided Wire or PVC Wire (whichever is correct for the application), using Soldered & Heat Sealed Brass or Copper Terminals.

Ford Model A 1928-1931

B2000-004	Positive Ground Strap	\$10.50
B2070-001	Negative Battery Cable	\$32.75

Ford Model AA 1928-1931

B2000-004	Positive Ground Strap	\$10.50
B2070-002	Negative Battery Cable	\$36.50

Ford Car 1932 V8

B2000-006	Positive Ground Strap	\$13.50
B2070-003	Negative Battery Cable	\$55.25

Ford Car 1933-1934 V8

B2000-008	Negative Ground Strap	\$15.50
-----------	-----------------------	---------

Ford Car 1935-1936 V8

B2000-006	Positive Ground Strap	\$13.50
B2070-004	Negative Battery Cable	\$45.25
B2070-036	Switch to Starter Cable	\$44.75

Ford Car 1937-1939

B2000-004	Positive Ground Strap	\$10.50
B2070-005	Negative Battery Cable	\$35.00
B2070-006	Switch to Starter Cable	\$31.50

Ford Car 1940-1948 V8

B2000-002	Positive Ground Strap	\$9.50
B2070-008	Negative Battery Cable	\$36.50
B2070-009	Switch to Starter Cable	\$35.50

Ford Car 6 Cyl. 1941-1947

B2000-007	Positive Ground Strap	\$14.50
B2070-010	Negative Battery Cable	\$46.75
B2070-011	Switch to Starter Cable	\$35.50

Ford Car 6 Cyl. 1948

B2000-007	Positive Ground Strap	\$14.50
B2070-012	Negative Battery Cable	\$31.25
B2070-013	Switch to Starter Cable	\$46.50

Ford Car 1949-1951 V8

B2000-009	Negative Ground Strap	\$17.00
B2070-014	Negative Battery Cable	\$31.25
B2070-015	Switch to Starter Cable	\$60.25

Ford Car 6 Cyl. 1949-1951

B2000-009	Negative Ground Strap	\$17.00
B2070-016	Negative Battery Cable	\$31.25
B2070-017	Switch to Starter Cable	\$60.25

Ford Car 6 Cyl. 1952-1953

B2070-018	Positive Battery Cable	\$37.00
B2070-019	Negative Battery Cable	\$37.00
B2070-020	Switch to Starter Cable	\$29.75

Ford Car 1952-1953 V8

B2070-021	Positive Battery Cable	\$37.00
B2070-022	Negative Battery Cable	\$37.00
B2070-023	Switch to Starter Cable	\$32.00

Ford Car 6 Cyl. 1954

B2070-024	Positive Battery Cable	\$41.25
B2070-025	Negative Battery Cable	\$28.00
B2070-026	Switch to Starter Cable	\$41.75

Ford Car 1954 V8

B2070-027	Positive Battery Cable	\$41.25
B2070-028	Negative Battery Cable	\$28.00
B2070-029	Switch to Starter Cable	\$41.75

Ford Car 6 Cyl. 1955

B2070-030	Positive Battery Cable	\$34.00
B2070-031	Negative Battery Cable	\$34.00
B2070-032	Switch to Starter Cable	\$41.75

Ford Car 1955 V8

B2070-033	Positive Battery Cable	\$41.25
B2070-034	Negative Battery Cable	\$34.00
B2070-035	Switch to Starter Cable	\$41.75

REPLACEMENT DISTRIBUTORS



Ford 4 Cyl. 1941-1942

9N12100	Distributor	\$129.75
New 4 Cyl. Complete Replacement Front Mount Distributor		

TUNE UP PARTS

Ford 4 Cylinder Model T

with American Bosch Distributor Type T666

	B4001-004	\$45.00
	Points	

*For 6-Volt Ignition Coils & Accessories, see p.44



Ford 4 Cylinder 1928-1931

	B4001-026	\$18.25
	Points Replaces: #A12199	

	B4002-017	\$7.75
Condenser Replaces: #A12300, DC-1		
	B4003-045	\$35.50
Cap (Body) Replaces: #A12105, B12105		
	B4004-030	\$8.50
Rotor Replaces: #B12200		
	B4003-046	\$10.50
Cap (Top) Replaces: #A121115, B121115		

*For 6-Volt Ignition Coils & Accessories, see p.44



Ford 4 Cylinder 1941-1942		
	B4100-009	\$11.75
PCR Kit Includes: Points (#B4001-009), Condenser (#B4002-008), Rotor (#B4004-008) Replaces: Points - #DP-61,8N-12107 Condenser - #91A-12300, DC-10 Rotor - #9N-12200		
	B4003-008	\$14.75
Cap Replaces: #9M-12106		
	B4004-008	\$6.50
Rotor Replaces: #9N-12200		
	B4005-001	\$35.75
Coil (6 Volt) Replaces: #9N-12024		
	B4005-002	\$35.75
Coil (12 Volt) Replaces: #9N-12024		
	B4008-002	\$5.75
Gasket Set Replaces: #9N-12104		
	B9510-001	\$134.45
Ford Front Mount External Coil Connection Kit 12-Volt, Negative Ground		



Ford 4 Cylinder 1968-1972		
	B4003-075	\$17.00
Cap		
	B4004-046	\$6.25
Rotor		



Ford 6 Cylinder 1948-1967 All (1966-1967 without T.E.C.)		
	B4100-005	\$9.75
PCR Kit Includes: Points (#B4001-010), Condenser (#B4002-009), Rotor (#B4004-009) Replaces: Points - #FAA-12171A (DP-3), 7RA-12171 (DP-7) Condenser - #7RA-12300, DC-6 Rotor - #1972022, DR-1		
	B4003-047	\$16.25
Cap Replaces: #7HA-12106		
	B4004-009	\$4.75
Rotor Premium Grade, Made in the USA Replaces: #1972022, DR-1		
	B4007-005	\$4.25
Rotor Clip Replaces: #8N-12213		

*For 6-Volt Ignition Coils & Accessories, see p.44

Ford 6 Cylinder 1966-1974 All 1966-1967 with T.E.C.		
	B4001-010	\$4.75
Points Replaces: #FAA-12171A (DP-3), 7RA-12171 (DP-7)		
	B4002-018	\$10.50
Condenser Replaces: #B9AF-12300, DC-13A		
	B4003-047	\$16.25
Cap Replaces: #7HA-12106		
	B4004-031	\$7.00
Rotor Replaces: #3230821, F-405		

Ford 6 Cylinder 1975-1976		
	B4003-073	\$30.00
	Cap Replaces: #D5DZ-12106A, D7TZ-12106B (DH-353)	
	B4004-031	\$7.00
	Rotor Replaces: #3230821, F-405	

Ford 6 Cylinder 1977-1985		
	B4003-061	\$13.50
	Cap Made in the USA Replaces: #D7DZ-12106A, DH-367	
	B4004-039	\$4.75
	Rotor Made in the USA Replaces: #E6TZ-12200A, D	

Ford 8 Cylinder 1936 Late, -1941 (All)		
	B4001-027	\$25.75
	Points Set of 2 Replaces: #9N-12107, DP-2, DP-61	
	B4002-020	\$14.75
	Condenser Replaces: #78-12300, DC-7	

Ford 8 Cylinder 1942 (All)		
	B4001-027	\$25.75
	Points Set of 2 Replaces: #9N-12107, DP-2, DP-61	
	B4002-019	\$8.75
	Condenser Replaces: #1GA-12300B, DC-4	
	B4003-048	\$41.25
	Cap Replaces: #21A-1206A	
	B4004-032	\$11.50
	Rotor Replaces: #21A-12200	

Ford 8 Cylinder 1943-1945 (All)		
	B4001-027	\$25.75
	Points Set of 2 Replaces: #9N-12107, DP-2, DP-61	
	B4002-019	\$8.75
	Condenser Replaces: #1GA-12300B, DC-4	
	B4003-048	\$41.25
	Cap Replaces: #21A-1206A	
	B4004-009	\$4.75
	Rotor Premium Grade, Made in the USA Replaces: #1972022, DR-1	
	B4007-005	\$4.25
	Rotor Clip Replaces: #8N-12213	



Ford 8 Cylinder 1948 (All)		
	B4001-027	\$25.75
	Points Set of 2 Replaces: #9N-12107, DP-2, DP-61	
	B4002-019	\$8.75
	Condenser Replaces: #1GA-12300B, DC-4	
	B4003-048	\$41.25
	Cap Replaces: #21A-1206A	
	B4004-009	\$4.75
	Rotor Premium Grade, Made in the USA Replaces: #1972022, DR-1	
	B4007-005	\$4.25
	Rotor Clip Replaces: #8N-12213	



Ford 8 Cylinder 1949-1953 (All)		
	B4100-005	\$9.75
	PCR Kit Includes: Points (#B4001-010), Condenser (#B4002-009), Rotor (#B4004-009) Replaces: Points - #FAA-12171A (DP-3), 7RA-12171 (DP-7) Condenser - #7RA-12300, DC-6 Rotor - #1972022, DR-1	
	B4003-049	\$18.75
Cap Replaces: #FAB-12106A, DH-1		
	B4007-005	\$4.25
Rotor Clip Replaces: #8N-12213		
	B4004-009	\$4.75
Rotor Premium Grade, Made in the USA Replaces: #1972022, DR-1		

Ford 8 Cylinder 1954-1956		
	B4001-028	\$7.00
	Points Replaces: #FAB-12171A, FAB-12171B (DP-4, DP-5), (Holley) 76D-94AS, (IHC) 149356-R92	
	B4002-009	\$4.75
	Condenser Replaces: #7RA-12300, FAB-12300A, DC-2, DC-6	
	B4003-049	\$18.75
	Cap Replaces: #FAB-12106A, DH-1	
	B4004-009	\$4.75
	Rotor Premium Grade, Made in the USA Replaces: #1972022, DR-1	
	B4007-005	\$4.25
	Rotor Clip Replaces: #8N-12213	

*For 6-Volt Ignition Coils & Accessories, see p.44

Ford 8 Cylinder 1957-1959		
	B4001-011	\$4.75
	Points Replaces: #B7A-12171A, B8Q-12171A, DP-9	

	B4003-050	\$14.00
	Cap Replaces: #B7A12106A, DH-6	
	B4004-033	\$5.50
	Rotor Replaces: #3230765, F-400	

Ford 8 Cylinder 1960-1974 (with Single Points)		
	B4001-011	\$4.75
	Points Replaces: #B7A-12171A, B8Q-12171A, DP-9	
	B4002-018	\$10.50
	Condenser Replaces: #B9AF-12300, DC-13A	
	B4003-050	\$14.00
	Cap Replaces: #B7A12106A, DH-6	
	B4004-033	\$5.50
	Rotor Replaces: #3230765, F-400	

Ford 1960-1972 (All with Dual Points)		
	B4001-028	\$12.75
	Points Replaces: #FDS-12171A, DP-6, C8AZ-12171A	
	B4002-009	\$4.75
	Condenser Replaces: #7RA-12300, FAB-12300A, DC-2, DC-6	
	B4003-050	\$14.00
	Cap Replaces: #B7A12106A, DH-6	
	B4004-033	\$5.50
	Rotor Replaces: #3230765, F-400	

Ford 8 Cylinder 1977-1993		
	B4003-063	\$24.25
	Cap Made in the USA Replaces: #D7AZ-12106A, DH-366	

ELECTRONIC IGNITION CONVERSION KITS

Replaces Points & Condenser



Ford 4 Cyl. 1971-1973 with Motorcraft 1600cc Engine

B9600-306LS | 12 Volt Negative Ground | **\$185.95**

Ford 4 Cyl. 1971-1974 with Bosch Distributor

B9600-097V | 12 Volt Negative Ground | **\$110.95**

Ford 4 Cyl. 1974 with Motorcraft Distributor

B9600-030 | 12 Volt Negative Ground | **\$154.95**

Ford 6 Cyl. 1949-1974 with FoMoCo, Autolite, & Motorcraft Distributor Except V6

B9600-032 | 12 Volt Negative Ground | **\$124.95**

Ford 6 Cyl. 1963-1967 with Holley Distributor Except V6

B9600-036 | 12 Volt Negative Ground | **\$124.95**

B9600-036N6 | 6 Volt Negative Ground | **\$139.95**

Ford 6 Cyl. 1974 Mustang with Bosch Distributor

B9600-104 | 12 Volt Negative Ground | **\$132.95**

Ford 8 Cyl. 1942-1948 with Ford Front Mount Distributor & Lobe Sensor

B9600-040LS | 12 Volt Negative Ground | **\$175.45**

Ford 8 Cyl. 1949-1953

B9600-039 | 12 Volt Negative Ground | **\$139.95**

B9600-039N6 | 6 Volt Negative Ground | **\$154.95**

B9600-039P6 | 6 Volt Positive Ground | **\$154.95**

Ford 8 Cyl. 1954-1956

B9600-038 | 12 Volt Negative Ground | **\$139.95**

B9600-038N6 | 6 Volt Negative Ground | **\$154.95**

B9600-038P6 | 6 Volt Positive Ground | **\$154.95**

Ford 8 Cyl. 1957-1974 with Single Point Distributor

B9600-037 | 12 Volt Negative Ground | **\$117.95**

Ford 8 Cyl. 1960-1972 Dual Point Distributor
Mechanical Advance Distributor

B9600-037D | 12 Volt Negative Ground | **\$101.23**

Vacuum Advance Distributor

B9600-037DV | 12 Volt Negative Ground | **\$124.95**

Ford 8 Cyl. 1977-1983 with Upgraded Current Protection

B9600-182II | 12 Volt Negative Ground | **\$206.45**

STARTER SWITCHES & SOLENOIDS

B5007-005 | 6 Volt Isolated Base Solenoid | **\$17.75**



Has a Flat Bracket & 3 Terminal Post.
Works with 6 Volt Systems.
Isolated base/ isolated ground.
Replaces:
Autolite/ Prestolite - #SW1, SW219
Delco - #DR1494, U925, U928
Ford - #NCA11450A, 21A-11450

Fits: **Ford** - 1940-1950

B5007-008 | 12 Volt Solenoid with Bakelite Case for Ford Cars | **\$17.75**



This Solenoid has a Flat Mounting Bracket & is 12 Volts. It has 4 Terminals with a Bakelite Housing. It has 5/16-24 Thread for Battery and Motor Post and a 10-32 Post for the Terminal Switch.

Replaces:
Delco - #1972255, 1974921

Prestolite - #15-394, 15-406, 15-411, 15-444, 15-486, SAS-4217Y, SAZ-4201BBY, SAZ-4201BW, SAZ-4201CPY, SAZ-4201EW

Ford - #B6AZ-11450-A, DZAF-11450-AA, SW-3

Fits: **Ford Car** - 1956-1978

B7003-001 | Starter Brush Spring | **\$2.50**



For Ford 4-1/2" Cover Band Starters

Replaces:

Ford- #B-11059, C3NF11001B, D0DF11001D, D0DF11002A, D1AF-11059-AA, D1AZ-11059-A, MS452, MS502, MSC65

Prestolite- #50-363, 50-65, MZ-19, MZ-19A, MZ-19S

Fits starters: **Ford**- (various)

Prestolite- #46-3561, MDU6103, MDU6103S

SWITCHES

B5010-018 | Turn Signal Light Switch | **\$73.50**



Universal Turn Signal Switch. Has right turn, left turn, and warning flasher modes. Metal Construction with Color Coded Wire Leads. Fuse, clamp ring, and instruction sheet included.

Fits: Pre-1953 Vehicles

FLASHERS

B9017-040 | 6-Volt Thermal Flasher | **\$9.75**



6-Volt Thermal Flasher, Three Terminal
Replaces: #535

Ford

Fits: 1949-52



***For Ignition Coils & Accessories, see p.44**

VOLTAGE REGULATORS

Note: Due to modern battery design, voltage regulators can't be used to charge low or dead batteries. Doing so will destroy the voltage regulator and void the warranty.

B8002-005	6-Volt Ford Voltage Regulator	\$94.75
	6 Volt, 3 Terminal, Positive Ground, B Circuit Voltage Regulator Replaces Ford #B5A10505C, FAC10505A, FAC10505A1, GR1, GR7, GR8 Fits: Ford Car - 1938-1955 All PREMIUM QUALITY/ USA/ MADE	
B8002-035	12-Volt Ford Voltage Regulator	\$109.75
	Ford Car Replaces: #B8A-10105A/B, B8E-10505B/C, B9C-10505A, C1TF-10505C, C2AF-10505B, C2AZ-10505B/C, C2SZ-10505A, C2TF-10505A, C3TZ-10505A, C0AF-10505B, C0MF-10505A, FBF-10505A/B, PB7M-10505A, 2900423 Fits: 1956-1962 PREMIUM QUALITY/ USA/ MADE	
B8002-033	12-Volt Ford Alternator Voltage Regulator	14.75
	Ford Car Replaces: C3SZ-10316-A, C3SZ-10316-B, C3TF-10316-B, C3XF-10316-C, C4SF-10316-A, C4SZ-10316-A, C4TF-10316-B, C4TF-10316-D, C4UF-10316-A, C4UF-10316-B, C5AF-10316-A, C5AZ-10316-A, C5TF-10316-A, C8AF-10316-A, C8TF-10316-A, D0AF-10316-A, D3TZ-10316-A, GR341, GR341A, GR503, GR533, GR534 Fits Alternators: 1964-1978 PREMIUM QUALITY/ USA/ MADE	

B8002-040	12-Volt Alternator Voltage Regulator	\$31.50
	Replaces: Prestolite: 105-223, 105-205, 105-210, 105-228, 105-230 Ford: D3JL-10316-A, D3JL-10316-AB, D3NN-10316-A, D7NN-10316-B Fits: 8HA Series Alternators	

GENERATOR BEARING & BRUSH SETS

A10000RK	6 Volt, 3 Brush Generator Repair Kit	\$12.75
	Consisting of 3 Brushes, 1 Ball Bearing & 1 Bushing Fits Ford Generator #10000B Ford Fits: Model A 1928-1931	

ALTERNATORS

Delco 10SI Type



B6001-001	12 Volt Alternator (1 Wire)	\$112.75
63 Amp, Low Cut In, Specially Built For Tractors, Forklifts, & Other Low Engine Speed Applications		
B6001-002	12 Volt Alternator (1 Wire/ 3 Wire)	\$118.75
63 Amp, With 1 Wire Or 3 Wire For Warning Lamp On Automobiles & Trucks		
B6001-005	6 Volt Alternator (1 Wire, Positive Ground)	\$166.50
6 Volt, 40 Amp Alternator with Positive Ground, 1 Wire, 3/8" pulley		

FORD TRUCK

TABLE OF CONTENTS

Spark Plug Wire Sets _____	477
Battery Cables _____	477
Wire Harnesses _____	478
Electronic Ignition Conversion Kits _____	478
Voltage Regulators _____	479
Solenoids _____	479
Switches _____	479
Flashers, Alternators _____	479

SPARK PLUG WIRE SETS

Our Spark Plug Wire Sets Come Fully Assembled with the Proper Type Wire & Terminals.

They are Custom Tailored to Look & Fit Like Original Factory Equipment.

Varieties include:

Cotton Braid Wire: Copper Core with a Cotton Jacket.

PVC Wire: Copper Core with a Rubber Jacket.

EPDM Wire (E): Hi Performance Premium Conductor with a Tinned Copper Core, EPDM Insulation, Rubber Jacket.

Suppression Wire (S): for Electronic Ignition and is Spiral Wound, Low-Ohm, with EPDM Silicone Insulation and a Rubber Jacket.

Cotton Braid Suppression Wire (CS): also for Electronic Ignition, as Suppression Wire, but has an additional layer of Cotton Braid & Lacquer to replicate the vintage look, as well.



Ford Model T with Coils On Dash

4 Cyl. Tailored Spark Plug Wire Set

B1071-001	Original Type Cotton Braid Wire	\$36.50
------------------	--	----------------

Ford Model A

Coil Wire

B1071-002	Original Type Cotton Braid Wire	\$10.00
------------------	--	----------------

6-Cylinder

Ford Truck 1941-1946

6 Cyl. Tailored Spark Plug Wire Set

B1071-004	Original Type Cotton Braid Wire	\$50.75
B1071-004E	EPDM Wire	\$55.50

Ford Truck 1947-1951

6 Cyl. Tailored Spark Plug Wire Set

Replaces #7HA-12259

B1071-005	Original Type PVC Wire	\$46.00
B1071-005E	EPDM Wire	\$55.50
B1071-005S	Suppression Wire	\$55.50

Ford Truck 1965-1976 w/ 170", 200", 250" Engines

6 Cyl. Tailored Spark Plug Wire Set

B1070-013	Original Type EPDM Wire	\$55.50
B1070-013S	Suppression Wire	\$55.50

8-Cylinder

Ford Truck 1937-1941

8 Cyl. Tailored Spark Plug Wire Set

Replaces #78-12259

B1071-006	Original Type Cotton Braid Wire	\$68.00
B1071-006E	EPDM Wire	\$74.00

Ford Truck 1942-1944

See #B1070-007 Ford Car (p.470) Replaces #21A-12259

Ford 1945-1947

8 Cyl. Tailored Spark Plug Wire Set, Replaces #59A-12259

B1070-014	Original Type Cotton Braid Wire	\$68.00
B1070-014E	EPDM Wire	\$74.00
B1070-014S	Suppression Wire	\$74.00
B1070-014CS	Cotton Suppression Wire	\$117.25

Ford Truck 1949-1952

8 Cyl. Tailored Spark Plug Wire Set

B1071-008	Original Type Cotton Braid Wire	\$68.00
B1071-008E	EPDM Wire	\$74.00
B1071-008S	Suppression Wire	\$74.00
B1071-008CS	Cotton Suppression Wire	\$117.25

Ford Truck 1953

8 Cyl. Tailored Spark Plug Wire Set

B1071-009	Original Type PVC Wire	\$61.75
B1071-009E	EPDM Wire	\$74.00
B1071-009S	Suppression Wire	\$74.00

Ford Truck 1974-1979

w/ 361", 391", 401", 475", 477", 534" Engines

8 Cyl. Tailored Spark Plug Wire Set

B1070-012	Original Type EPDM Wire	\$72.50
B1070-012S	Suppression Wire	\$72.50

BATTERY CABLES



Our Battery Cables are made from the Proper Gauge Copper, as either **Black Cotton Braided Wire** or **PVC Wire** (whichever is correct for the application), using Soldered & Heat Sealed Brass or Copper Terminals.

Ford Truck 1936

B2071-001	Positive Battery Cable	\$39.25
B2071-002	Negative Battery Cable	\$37.00
B2071-003	Switch to Starter Cable	\$51.75

Ford Truck 1941

B2071-004	Positive Battery Cable	\$42.50
B2071-005	Negative Battery Cable	\$38.25
B2071-006	Switch to Starter Cable	\$42.50

Ford Truck 1948-1950

B2071-007	Positive Battery Cable (6 cyl or V8)	\$37.50
B2071-008	Negative Battery Cable (6 cyl or V8)	\$30.00

B2071-009	Switch to Starter Cable for 6 cyl.	\$64.50
B2071-010	Switch to Starter Cable for V8	\$42.25



WIRING HARNESSSES

Our Wire Harnesses are made with our **premium cotton braid and/or PVC wire**.

They have the **correct gauge, color, wire, & fuse holders** (if needed).

All terminals are **soldered according to the original**.

(Harnesses do not include Battery Cables & Spark Plug Wires; however, we can supply these as separate products.)

NO HIDDEN COSTS, NOTHING EXTRA TO BUY!

Ford Truck 1948-1950 6 Cyl.

B3071-001	Complete Wire Harness	\$748.75
B3071-004	Complete Wire Harness, Modified for Turn Signals	\$889.00

Ford Truck 1948-1950 V8

B3071-002	Complete Wire Harness	\$748.75
B3071-005	Complete Wire Harness, Modified for Turn Signals	\$889.00

Ford Truck 1953 F6

B3071-003	Engine & Dash Only Wire Harness with OHV V8 #FAL 1444-A	\$679.75
------------------	--	-----------------

Note

When ordering, please specify **Year** or **Serial Number**, Magneto/Distributor, & Regulator/Cut Out Relay.

Some Harnesses were originally made with PVC Wire & Braided; others were made with PVC Wire & Taped.

In those cases, we build them the **Original Way**.

ELECTRONIC IGNITION CONVERSION KITS

Replaces Points & Condenser



Ford Truck 4 Cyl. 1941-1942 with Front Mount Distributor (Uses Original Coil)		
B9600-183	12 Volt Negative Ground	\$159.95
B9600-183P6	6 Volt Positive Ground	\$185.95

Ford Truck 4 Cyl. 1941-1942 with Front Mount Distributor (Uses External Replacement Pertronix Coil)		
B9600-183XT	12 Volt Negative Ground	\$298.95
B9600-183XTP6	6 Volt Positive Ground	\$309.45
B9503-005	Distributor Cap	\$37.45

Ford Truck 6 Cyl. 1949-1975 with FoMoCo, Autolite, & Motorcraft Distributor		
B9600-032	12 Volt Negative Ground	\$124.95

Ford Truck 6 Cyl. 1963-1967 with Holley Distributor		
B9600-036	12 Volt Negative Ground	\$124.95
B9600-036N6	6 Volt Negative Ground	\$139.95

Ford Truck 8 Cyl. 1949-1953		
B9600-039	12 Volt Negative Ground	\$139.95
B9600-039N6	6 Volt Negative Ground	\$154.95
B9600-039P6	6 Volt Positive Ground	\$154.95

Ford Truck 8 Cyl. 1954-1956		
B9600-038	12 Volt Negative Ground	\$139.95
B9600-038N6	6 Volt Negative Ground	\$154.95
B9600-038P6	6 Volt Positive Ground	\$154.95

Ford Truck 8 Cyl. 1957-1974 Single Point Distributor		
B9600-037	12 Volt Negative Ground	\$117.95

Ford 8 Cyl. 1977-1983 with Upgraded Current Protection		
B9600-182II	12 Volt Negative Ground	\$206.45





***For Ignition Coils & Accessories, see p.44**

VOLTAGE REGULATORS

Note: Due to modern battery design, voltage regulators can't be used to charge low or dead batteries. Doing so will destroy the voltage regulator and void the warranty.

B8002-005	6-Volt Ford Voltage Regulator	\$94.75
	6 Volt, 3 Terminal, Positive Ground, Voltage Regulator Replaces Ford # B5A10505C, FAC10505A, FAC10505A1, GR1, GR7, GR8 Fits: Ford Truck – 1938-1948 All PREMIUM QUALITY/ USA MADE	

B8002-035	12-Volt Ford Voltage Regulator	\$109.75
	Ford Truck Replaces: #B8A-10105A/B, B8E-10505B/C, B9C-10505A, C1TF-10505C, C2AF-10505B, C2AZ-10505B/C, C2SZ-10505A, C2TF-10505A, C3TZ-10505A, C0AF-10505B, C0MF-10505A, FBF-10505A/B, PB7M-10505A, 2900423 Fits: 1956-1962 PREMIUM QUALITY/ USA MADE	

B8002-033	Ford 12-Volt Alternator Voltage Regulator	14.75
	Ford Truck Replaces: C3SZ-10316-A, C3SZ-10316-B, C3TF-10316-B, C3XF-10316-C, C4SF-10316-A, C4SZ-10316-A, C4TF-10316-B, C4TF-10316-D, C4UF-10316-A, C4UF-10316-B, C5AF-10316-A, C5AZ-10316-A, C5TF-10316-A, C8AF-10316-A, C8TF-10316-A, D0AF-10316-A, D3TZ-10316-A, GR341, GR341A, GR503, GR533, GR534 Fits Alternators: 1965-1978 PREMIUM QUALITY/ USA MADE	

SOLENOIDS

B5007-005	6 Volt Isolated Base Solenoid	\$17.75
	Has a Flat Bracket & 3 Terminal Post. Works with 6 Volt Systems. Isolated base/ isolated ground. Replaces: Autolite/ Prestolite – #SW1, SW219 Delco - #DR1494, U925, U928 Ford - #NCA11450A, 21A-11450 Fits: Ford – 1940-1950	

B5007-008	12 Volt Solenoid with Bakelite Case for Ford Trucks	\$17.75
	Has a Flat Mounting Bracket & is 12 Volts. It has 4 Terminals with a Bakelite Housing. It has 5/16-24 Thread for Battery and Motor Post and a 10-32 Post for the Terminal Switch. Replaces: Delco - #1972255, 1974921 Prestolite - #15-394, 15-406, 15-411, 15-444, 15-486, SAS-4217Y, SAZ-4201BBY, SAZ-4201BW, SAZ-4201CPY, SAZ-4201EW Ford – #B6AZ-11450-A, DZAF-11450-AA, SW-3 Fits: Ford Truck – 1956-1980	

SWITCHES

B5010-018	Turn Signal Light Switch	\$73.50
	Universal Turn Signal Switch. Has right turn, left turn, and warning flasher modes. Metal Construction with Color Coded Wire Leads. Fuse, clamp ring, and instruction sheet included. Fits: Pre-1953 Vehicles	

FLASHERS

B9017-040	6-Volt Thermal Flasher	\$9.75
	6-Volt Thermal Flasher, Three Terminal Replaces: #535 Ford Truck Fits: 1949-52	

ALTERNATORS

Delco 10SI Type



B6001-001	12 Volt Alternator (1 Wire)	\$112.75
63 Amp, Low Cut In, Specially Built For Tractors, Forklifts, & Other Low Engine Speed Applications		
B6001-002	12 Volt Alternator (1 Wire/ 3 Wire)	\$118.75
63 Amp, With 1 Wire Or 3 Wire For Warning Lamp On Automobiles & Trucks		
B6001-005	6 Volt Alternator (1 Wire, Positive Ground)	\$166.50
6 Volt, 40 Amp Alternator with Positive Ground, 1 Wire, 3/8" pulley		

FRANKLIN

SPARK PLUG WIRE SETS

Our Spark Plug Wire Sets Come Fully Assembled with the Proper Type Wire & Terminals.

They are Custom Tailored to Look & Fit Like Original Factory Equipment.

Varieties include:

Cotton Braid Wire: Copper Core with a Cotton Jacket.

EPDM Wire (E): Hi Performance Premium Conductor with a Tinned Copper Core, EPDM Insulation, Rubber Jacket.

Suppression Wire (S): for Electronic Ignition and is Spiral Wound, Low-Ohm, with EPDM Silicone Insulation and a Rubber Jacket.

Cotton Braid Suppression Wire (CS): also for Electronic Ignition, as Suppression Wire, but has an additional layer of Cotton Braid & Lacquer to replicate the vintage look, as well.



Franklin 1910

4 Cyl. Tailored Spark Plug Wire Set

B1073-001	Original Type Cotton Braid Wire	\$38.00
------------------	---------------------------------	----------------

Franklin 1931 Model 151, 152, 153

6 Cyl. Tailored Spark Plug Wire Set

B1073-002	Original Type Cotton Braid Wire	\$68.00
B1073-002E	EPDM Wire	\$74.00
B1073-002S	Suppression Wire	\$74.00
B1073-002CS	Cotton Suppression Wire	\$117.25

Franklin 6 Cyl 1931 Model 163

6 Cyl. Tailored Spark Plug Wire Set

B1073-003	Original Type Cotton Braid Wire	\$60.00
B1073-003E	EPDM Wire	\$65.50
B1073-003S	Suppression Wire	\$65.50
B1073-003CS	Cotton Suppression Wire	\$103.50

BATTERY CABLES



Our Battery Cables are made from the Proper Gauge Copper, as either Black Cotton Braided Wire or PVC Wire (whichever is correct for the application), using Soldered & Heat Sealed Brass or Copper Terminals.

Franklin Car 1930-1931

B2073-001	Negative Battery Cable	\$60.00
------------------	------------------------	----------------



*For Ignition Coils & Accessories, see p.44

TUNE UP PARTS

Franklin 6 Cylinder All 1929-1934

	B4100-001	\$10.50
	PCR Kit Includes: Points (#B4001-001), Condenser (#B4002-001), Rotor (#B4004-002) Replaces: Points - #D100HP, 1855720 Condenser - #1928111, D-203, 1869704, D-200 Rotor - #820445, D400	
	B4004-002	\$5.75
	Rotor Replaces: #820445, D400	
	B4003-002	\$20.25
	Distributor Cap Premium Grade, Made in the USA (Brass Contacts) Replaces: #824735, D301	
	B4007-001	\$11.95
	Cap Clip Short Mount, 1 Used Replaces: #1889967, 1847289, 453844, 453461	
	B4007-002	\$11.95
	Cap Clip Long Mount, 1 Used Replaces: #1889967, 1889999, 453844, 453461	
	B4008-001	\$14.99
	Distributor Insulator Replaces: #1904376	
	B4009-001	\$25.99
	Distributor Bushing & Shim Kit	
B4006-001	Dust Cover Replaces: #1900119	\$9.99

*For 6- or 12-Volt Ignition Coils & Accessories, see p.44

ELECTRONIC IGNITION CONVERSION KITS

Replaces Points & Condenser





Franklin 6 Cyl. All 1929-1934

B9600-255LS	12 Volt Negative Ground	\$162.45
B9600-255LSP12	12 Volt Positive Ground	\$175.45
B9600-255LSP6	6 Volt Positive Ground	\$175.45

CUTOUT RELAYS & VOLTAGE REGULATORS

Note: Due to modern battery design, voltage regulators can't be used to charge low or dead batteries. Doing so will destroy the voltage regulator and void the warranty.

B8001-001	6-Volt Cutout Relay	\$19.50
	15 Amps, 6 Volt Works Positive or Negative Ground Replaces: Autolite - #CB4014, C4012(9-5), C4012(9-4), C4012(9-1), R40061 Delco - #266P, 266N, 265P, 265N, 5015850, 812970, 265J, 820845, 812971, 1116816, 265G, 265H, 1116755, 1116751, 1116809DR, 265B, 1842859, 265C, 1867781, 265F, 265D Fits: Franklin - 6 Cyl. All 1929-1934, & 12 Cylinder 1933 -1934	

B8001-002	Electronic Cutout Relay	\$19.50
	25 Amp, Works with 6, 12, or 24 Volts. & Positive or Negative Ground Replaces: Autolite - #CB4014, C4012(9-5), C4012(9-4), C4012(9-1), R40061 Delco - #266P, 266N, 265P, 265N, 5015850, 812970, 265J, 820845, 812971, 1116816, 265G, 265H, 1116755, 1116751, 1116809DR, 265B, 1842859, 265C, 1867781, 265F, 265D Fits: Franklin - 6 Cyl. All 1929-1934, & 12 Cylinder 1933 -1934	

6-Volt Saddle Mounted Cutout Relay (Delco Version)		
B8001-004	Premium Quality, Made in the USA	\$122.50
B8001-006	Standard Quality	\$38.59

	Cutout Relay, 25 Amp, 6 Volt, Works Positive or Negative Ground. Replaces: Delco - #266P, 266N, 265P, 265N, 5015850, 812970, 265J, 820845, 812971, 1116816, 265G, 265H, 1116755, 1116751, 1116809DR, 265B, 1842859, 265C, 1867781, 265F, 265D Fits: Franklin - 6 Cyl. 1929-1934, & 12 Cylinder 1933 -1934	
---	---	--

SWITCHES

B5010-018	Turn Signal Light Switch	\$73.50
	Universal Turn Signal Switch. Has right turn, left turn, and warning flasher modes. Metal Construction with Color Coded Wire Leads. Fuse, clamp ring, and instruction sheet included. Fits: Pre-1953 Vehicles	

IDENTIFICATION TAGS

B9013-004	Delco Remy I.D. Tag (Blank)	\$7.00
	(Stamped)	\$14.25
	Black Delco-Remy I.D. Tag for Distributors, 6 Volt Starters, & 6 Volt Generators with Rivets, 3/4" 2 5/16"	
B9013-003	Large Delco Remy I.D. Tag (Blank)	\$9.00
	(Stamped)	\$16.25
	Large Black Delco-Remy I.D. Tag for Distributors, 6 Volt Starters, & 6 Volt Generators with Rivets, 1 1/4" X 2 7/8"	
B9013-005	Red Delco Remy I.D. Tag (Blank)	\$7.00
	(Stamped)	\$14.25
	Red Delco-Remy I.D. Tag for 12 Volt Starters & 12 Volt Generators with Rivets, 3/4" 2 5/16"	

ALTERNATORS



Delco 10SI Type

B6001-001	12 Volt Alternator (1 Wire)	\$112.75
63 Amp, Low Cut In, Specially Built For Tractors, Forklifts, & Other Low Engine Speed Applications		
B6001-006	6 Volt Alternator (1 Wire, Negative Ground)	\$166.50
6 Volt, 40 Amp Alternator with Negative Ground, 1 Wire		

FRAZER

SPARK PLUG WIRE SETS

Frazer Car 1949-1951

4 Cyl. Tailored Spark Plug Wire Set

B1072-001	Original Type PVC Wire	\$46.00
B1072-001E	EPDM Wire	\$55.50
B1072-001S	Suppression Wire	\$55.50

BATTERY CABLES

Frazer Car 1947-1948

B2072-001	Positive Battery Cable	\$31.00
B2072-002	Negative Battery Cable	\$36.50

Frazer Car 1949-1951

B2072-003	Positive Battery Cable	\$31.75
B2072-004	Negative Battery Cable	\$24.50
B2072-005	Switch to Starter Cable	\$28.00

ELECTRONIC IGNITION

CONVERSION KITS

Replaces Points & Condenser



Frazer 6 Cyl. 1947-1950 All with Autolite IGS Series Distributor

B9600-307LS	12 Volt Negative Ground	\$169.45
B9600-307LSP6	6 Volt Positive Ground	\$185.95

ALTERNATORS

B6001-001	12 Volt Alternator (1 Wire)	\$112.75
------------------	-----------------------------	-----------------

63 Amp, Low Cut In, Specially Built For Tractors, Forklifts, & Other Low Engine Speed Applications

B6001-005	6 Volt Alternator (1 Wire, Positive Ground)	\$166.50
------------------	---	-----------------

6 Volt, 40 Amp Alternator with Positive Ground, 1 Wire, 3/8" pulley

SWITCHES

B5010-018	Turn Signal Light Switch	\$73.50
------------------	--------------------------	----------------

Universal Turn Signal Switch. Has right turn, left turn, and warning flasher modes. Metal Construction with Color Coded Wire Leads. Fuse, clamp ring, and instruction sheet included. Fits: Pre-1953 Vehicles

GMC TRUCK

TABLE OF CONTENTS

Spark Plug Wire Sets, Battery Cables	482
Wiring Harnesses	483
Tune Up Parts	483
Electronic Ignition Conversion Kits	485
Cutout Relays & Voltage Regulators	486
Identification Tags	487
Switches	487
Alternators	487

SPARK PLUG WIRE SETS

Our Spark Plug Wire Sets Come Fully Assembled with the Proper Type Wire & Terminals.

They are Custom Tailored to Look & Fit Like Original Factory Equipment.

Varieties include:

Cotton Braid Wire: Copper Core with a Cotton Jacket.

EPDM Wire (E): Hi Performance Premium Conductor with a Tinned Copper Core, EPDM Insulation, Rubber Jacket.

Suppression Wire (S): for Electronic Ignition and is Spiral Wound, Low-Ohm, w/ EPDM Insulation, Rubber Jacket.

Cotton Braid Suppression Wire (CS): also for Electronic Ignition, as Suppression Wire, but has an additional layer of Cotton Braid & Lacquer to replicate the vintage look, as well.



GMC 1930

6 Cyl. Tailored Spark Plug Wire Set

B1074-001	Original Type Cotton Braid Wire	\$56.25
B1074-001E	EPDM Wire	\$61.25
B1074-001S	Suppression Wire	\$61.25
B1074-001CS	Cotton Suppression Wire	\$97.00

GMC 1941-1954

6 Cyl. Tailored Spark Plug Wire Set

B1074-002	Original Type Cotton Braid Wire	\$50.75
B1074-002E	EPDM Wire	\$55.50
B1074-002S	Suppression Wire	\$55.50
B1074-002CS	Cotton Suppression Wire	\$87.50

GMC 1955-1975

6 Cyl. Tailored Spark Plug Wire Set

B1074-003	Original Type EPDM Wire	\$55.50
B1074-003S	Suppression Wire	\$55.50

BATTERY CABLES

GMC Truck 1950-1954

HCW 400, HV, HA, 450-470

B2000-005	Positive Ground Strap	\$12.50
B2074-001	Negative Battery Cable	\$46.25



WIRING HARNESSSES

Our Wire Harnesses are made with our **premium cotton braid and/or PVC wire**.

They have the **correct gauge, color, wire, & fuse holders** (if needed).

All terminals are **soldered according to the original**.

(Harnesses do not include Battery Cables & Spark Plug Wires; however, we can supply these as separate products.)

NO HIDDEN COSTS, NOTHING EXTRA TO BUY!

GMC Truck 1950-1952

B3074-001	Complete Wire Harness	\$1,000.25
------------------	------------------------------	-------------------

GMC Truck 1953-1955

B3074-002	Complete Wire Harness	\$1,000.25
------------------	------------------------------	-------------------

Note

When ordering, please specify **Year** or **Serial Number**, Magneto/Distributor, & Regulator/Cut Out Relay.

Some Harnesses were originally made with PVC Wire & Braided; others were made with PVC Wire & Taped.



In those cases, we build them the **Original Way**.



TUNE UP PARTS

GMC 4 Cylinder 1964-1966

	B4001-030 Points Replaces: #1954557, D-108P	\$4.75
	B4002-001 Condenser Replaces: #1928111, D-203, 1869704, D-200	\$4.75
	B4003-015 Distributor Cap Brass Contacts Replaces: #D-322	\$16.25
	B4004-013 Rotor Premium Grade, Made in the USA Replaces: #D-419R, 1963972	\$4.75
B4006-004	Dust Cover Replaces: #1960325	\$16.99

GMC 6 Cylinder 1930-1933, 1934-1935 (T14 & T16)

	B4001-021 Points Replaces: #1855520, D-109	\$13.75
	B4002-001 Condenser Replaces: #1928111, D-203, 1869704, D-200	\$4.75

	B4004-021 Rotor Replaces: #816774	\$14.75
	B4003-059 Cap Replaces: #816779, 822465, 1831800, 1853240	\$22.50



*For 6-Volt Ignition Coils & Accessories, see p.44

GMC 6 Cylinder 1947-1952 with Distributor #1112360 and others

	B4100-001 PCR Kit Includes: Points (#B4001-001), Condenser (#B4002-001), Rotor (#B4004-002) Replaces: Points - #D100HP, 1855720 Condenser - #1928111, D-203, 1869704, D-200 Rotor - #820445, D400	\$10.50
	B4004-002 Rotor Replaces: #820445, D400	\$5.75
	B4003-002 Distributor Cap Premium Grade, Made in the USA (Brass Contacts) Replaces: #824735, D301	\$20.25
	B4007-001 Cap Clip Short Mount, 1 Used Replaces: #1889967, 1847289, 453844, 453461	\$11.95
B4006-001	Dust Cover Replaces: #1900119	\$9.99

	B4007-002 Cap Clip Long Mount, 1 Used Replaces: #1889967, 1889999, 453844, 453461	\$11.95
	B4008-001 Distributor Insulator Replaces: #1904376	\$14.99
	B4009-001 Distributor Bushing & Shim Kit	\$25.99

*For 6- or 12-Volt Ignition Coils & Accessories, see p.44

GMC 6 Cylinder 1953-1958, [1959-1961 (All Except 1000 Thru 3500 Series)]		
	B4001-001 Points Replaces: #D100HP, 1855720	\$4.75
	B4002-001 Condenser Replaces: #1928111, D-203, 1869704, D-200	\$4.75
	B4003-034 Cap Replaces: #268574C92	\$18.25
	B4004-022 Rotor Replaces: #1924245, D-405	\$6.50





*For 6- or 12-Volt Ignition Coils & Accessories, see p.44



GMC 6 Cylinder 1961-1962,305A, 351, 401 Engine, & 1963 (All)		
	B4001-019 Points Replaces: #D-106PS	\$6.75
	B4002-001 Condenser Replaces: #1928111, D-203, 1869704, D-200	\$4.75
	B4003-051 Cap Replaces: #1945935, 1952738, D315	\$30.75
	B4004-020 Rotor Replaces: #1852722, 1932015, D-426R	\$4.50



*For 12-Volt Ignition Coils & Accessories, see p.44

GMC 6 Cylinder 1964-1974		
	B4100-003 PCR Kit Includes: Points (#B4001-012), Condenser (#B4002-012), Rotor (#B4004-013) Replaces: Points - #D108P Condenser - #D205 Rotor - #D-419R, 1963972	\$9.75
	B4004-013 Rotor Premium Grade, Made in the USA Replaces: #D-419R, 1963972	\$4.75
	B4003-021 Distributor Cap Replaces: #1954569, D-316	\$8.75
B4006-004	Dust Cover Replaces: #1960325	\$16.99

*For 6- or 12-Volt Ignition Coils & Accessories, see p.44

GMC 8 Cylinder 1955-1956 Model 93, 94, 95, & 96 Canada Models		
	B4001-020 Points Replaces: #1938340, 1882025, D104P, DR2437	\$14.50
	B4002-001 Condenser Replaces: #1928111, D-203, 1869704, D-200	\$4.75
	B4003-031 Cap Replaces: #O-305	\$17.50
	B4004-023 Rotor Replaces: #1927393, D-407	\$4.75

GMC 8 Cylinder 1955 (All Except Canada Models)		
	B4001-013 Points Replaces: #1938330 (D-103P), 1882024 (D103), 1871678, 1871870, 1918148	\$16.25
	B4002-001 Condenser Replaces: #1928111, D-203, 1869704, D-200	\$4.75

	B4003-031	\$17.50
	Cap Replaces: #O-305	
	B4004-023	\$4.75
	Rotor Replaces: #1927393, D-407	

*For 12-Volt Ignition Coils & Accessories, see p.44

GMC 8 Cylinder 1956 (All Except Canada)

	B4001-013	\$16.25
	Points Replaces: #1938330 (D-103P), 1882024 (D103), 1871678, 1871870, 1918148	
	B4002-001	\$4.75
	Condenser Replaces: #1928111, D-203, 1869704, D-200	
	B4003-031	\$17.50
	Cap Replaces: #O-305	
	B4004-023	\$4.75
	Rotor Replaces: #1927393, D-407	

*For 12-Volt Ignition Coils & Accessories, see p.44

GMC 8 Cylinder 1957-1967

	B4001-019	\$6.75
	Points Replaces: #D-106PS	
	B4002-016	\$4.75
	Condenser Replaces: #1932004, D-204	
	B4003-032	\$14.25
	Cap Premium Quality, Brass Contacts Replaces: #1942654, D309	
	B4004-020	\$4.50
	Rotor Replaces: #1852722, 1932015, D-426R	

*For 12-Volt Ignition Coils & Accessories, see p.44

GMC 8 Cylinder 1968-1974

	B4001-019	\$6.75
	Points Replaces: #D-106PS	
	B4002-016	\$4.75
	Condenser Replaces: #1932004, D-204	
	B4003-032	\$12.25
	Cap Premium Quality, Brass Contacts Replaces: #1942654, D309	
	B4004-020	\$4.50
	Rotor Replaces: #1852722, 1932015, D-426R	

*For 12-Volt Ignition Coils & Accessories, see p.44

ELECTRONIC IGNITION
CONVERSION KITS

Replaces Points & Condenser



GMC 6 Cylinder 1930-1933, 1934-1935 (T14 & T16)

B9600-309	12 Volt Negative Ground	\$154.95
B9600-309P6	6 Volt Positive Ground	\$169.45

GMC 6 Cyl. 1939-1962

with Distributor #1112360 and others

B9600-255LS	12 Volt Negative Ground	\$162.45
B9600-255LSN6	6 Volt Negative Ground	\$175.45



***For Ignition Coils & Accessories, see p.44**

CUTOUT RELAYS & VOLTAGE REGULATORS

Note: Due to modern battery design, voltage regulators can't be used to charge low or dead batteries. Doing so will destroy the voltage regulator and void the warranty.

B8001-001	6-Volt Cutout Relay	\$19.50
	15 Amps, 6 Volt Works Positive or Negative Ground Replaces: Autolite - #CB4014, C4012(9-5), C4012(9-4), C4012(9-1), R40061 Delco - #266P, 266N, 265P, 265N, 5015850, 812970, 265J, 820845, 812971, 1116816, 265G, 265H, 1116755, 1116751, 1116809DR, 265B, 1842859, 265C, 1867781, 265F, 265D Fits: GMC Truck - 1928 - 1939	

B8001-002	Electronic Cutout Relay	\$19.50
	25 Amp, Works with 6, 12, or 24 Volts. Positive or Negative Ground Replaces: Autolite - #CB4014, C4012(9-5), C4012(9-4), C4012(9-1), R40061 Delco - #266P, 266N, 265P, 265N, 5015850, 812970, 265J, 820845, 812971, 1116816, 265G, 265H, 1116755, 1116751, 1116809DR, 265B, 1842859, 265C, 1867781, 265F, 265D Fits: GMC Truck - 1928 - 1939	

6-Volt Saddle Mounted Cutout Relay (Delco Version)		
B8001-004	Premium Quality, Made in the USA	\$122.50
B8001-006	Standard Quality	\$38.59

	Cutout Relay, 25 Amp, 6 Volt, Works Positive or Negative Ground. Replaces: Delco - #266P, 266N, 265P, 265N, 5015850, 812970, 265J, 820845, 812971, 1116816, 265G, 265H, 1116755, 1116751, 1116809DR, 265B, 1842859, 265C, 1867781, 265F, 265D Fits: GMC Truck - 1928 - 1939	
---	--	--

B8002-003	6-Volt Delco Voltage Regulator	\$119.75
	6 Volt, 3 Terminal, 26-30 Amps, Positive Ground, (Premium Quality, Made in the USA) Replaces: Delco # 1118208, 1118215, 1118230, 1118234, 1118253, 1118271, 1118303, 1118350, 1118871, 1119176, 5559, 5596, 5597, 5810, 5811, 5813, 5818, 5828, 5831, 5861, 5865, 5867, 5874, D5865, D603 Fits: GMC Truck - 1940-1950	

6-Volt Delco Type Voltage Regulator		
B8002-001	Premium Quality, Made in the USA	\$87.75
B8002-042	Standard Quality	\$34.75
	6-Volt, 3-Terminal, 32-42 Amps, Negative Ground, Flat Mounting Bracket, A-Circuit Replaces: Delco - 1118201, 1118300, 1118301, 1118357, 1118364, 1118721, 1118843, 1118847, 1118869, 1118872, D601, D614, D653 Fits: GMC Truck - 1951-1952	

B8002-004	6-Volt Voltage Regulator	\$142.75
	6 Volt, 3 Terminal, Negative Ground, Voltage Regulator Replaces Delco #1118201, 1118207, 1118211, 1118216, 1118221, 1118233, 1118237, 1118242, 1118272, 1118301, 1118311, 1118313, 1118343, 1118349, 1118361, 1118720, 1118847, 1118866, 1118869, 1118872, 1118921, 5547, 5587, 5599, 5809, 5819, 5854, 5872, 5873, 5875, 5878, D601, D614, D653 Fits: GMC Truck - 1953-1955 PREMIUM QUALITY/ USA MADE	

B8002-006	12-Volt Voltage Regulator	\$67.50
	12 Volt, 3 Terminal, Negative Ground, Voltage Regulator Fits: GMC Truck - 1954-1962 All PREMIUM QUALITY/ USA MADE	

B8002-041	12-Volt Delco Voltage Regulator	\$78.75
	12 Volt, 4 Terminal, Flat Mounting (Premium Quality, Made in the USA) GMC Truck Replaces: Delco - #1118279, 1118339, 1118368, 1118838, 1118880, 1118881, 1118883, 1118939, 1119156, 1119200, 1119269, 1119607, D651 Fits: 1962-1963, 1965	

ALTERNATOR VOLTAGE REGULATORS

B8002-030	12-Volt Alternator Voltage Regulator	\$14.50
	Heavy Duty, 12 Volt, Negative Ground. External voltage regulator, has 4 spade terminals (field, 2, 3, 4). Designed for 'B' type circuits in negative ground systems. For use only in 12 volt systems, Delco 10DN, & 20DN Replaces: Delco - #D630, D635, D663, 1119513, 1119515, 1119508, 1119519, D663, 1119502, 1119516, 1119506, 1119512, 1119515 Fits: GMC Light Truck - 4, 6 Cyl. 1963-1964, 4, 6, 8 Cyl. 1965-1968, 6, 8 Cyl. 1969, 1970-1972	

IDENTIFICATION TAGS

B9013-003	Large Delco Remy I.D. Tag (Blank)	\$9.00
	(Stamped)	\$16.25
		Large Black Delco-Remy I.D. Tag for Distributors, 6 Volt Starters, & 6 Volt Generators with Rivets, 1 1/4" X 2 7/8"
B9013-004	Delco Remy I.D. Tag (Blank)	\$7.00
	(Stamped)	\$14.25
		Black Delco-Remy I.D. Tag for Distributors, 6 Volt Starters, & 6 Volt Generators with Rivets, 3/4" 2 5/16"
B9013-005	Red Delco Remy I.D. Tag (Blank)	\$7.00
	(Stamped)	\$14.25
		Red Delco-Remy I.D. Tag for 12 Volt Starters & 12 Volt Generators with Rivets, 3/4" 2 5/16"
B9013-013	Delco Remy I.D. Tag (Blank)	\$7.00
	(Stamped)	\$14.25
		Black Delco-Remy I.D. Tag for Distributors, 6 Volt Starters, & 6 Volt Generators with Rivets, 3/4" 2 5/16"

SWITCHES

B5010-018	Turn Signal Light Switch	\$73.50
		Universal Turn Signal Switch. Has right turn, left turn, and warning flasher modes. Metal Construction with Color Coded Wire Leads. Fuse, clamp ring, and instruction sheet included. Fits: Pre-1953 Vehicles

SOLENOIDS

B5007-042	6-Volt Delco Starter Solenoid Switch	\$52.75
		Replaces: Delco - #1114307, 1114310, 1114312, 1114410, 1118135, 1118140, 1118148, D936, D938, D939, D949, D964 Prestolite - #15-228, SWX-228, SWX-429 Fits: GMC Truck - 6 Cyl. 1942-1954, 8 Cyl. 1942-1954

ALTERNATORS

B6001-001	12 Volt Alternator (1 Wire)	\$112.75
63 Amp, Low Cut In, Specially Built For Tractors, Forklifts, & Other Low Engine Speed Applications		
B6001-005	6 Volt Alternator (1 Wire, Positive Ground)	\$166.50
6 Volt, 40 Amp Alternator with Positive Ground, 1 Wire, 3/8" pulley		

GRAHAM & GRAHAM-PAIGE

SPARK PLUG WIRE SETS

Graham-Paige

6 Cyl. Tailored Spark Plug Wire Set

B1076-001	Original Type Cotton Braid Wire	\$51.25
B1076-001E	EPDM Wire	\$56.00
B1076-001S	Suppression Wire	\$56.00
B1076-001CS	Cotton Suppression Wire	\$88.75

BATTERY CABLES

	
Our Battery Cables are made from the Proper Gauge Copper, as either Black Cotton Braided Wire or PVC Wire (whichever is correct for the application), using Soldered & Heat Sealed Brass or Copper Terminals.	

Graham 1930-1937

B2000-006	Positive Ground Strap	\$13.50
------------------	------------------------------	----------------

Graham 1938-1940 (All Except 107, 108)

B2075-001	Negative Battery Cable	\$45.25
------------------	-------------------------------	----------------

Graham 1940 (107, 108)

B2075-002	Negative Battery Cable	\$36.00
------------------	-------------------------------	----------------



TUNE UP PARTS



Graham-Paige 6 Cylinder 1929-1930 (with Delco Distributor #623E)		
	B4001-021	\$13.75
	Points Replaces: #1855520, D-109	
	B4002-001	\$4.75
	Condenser Replaces: #1928111, D-203, 1869704, D-200	
	B4004-021	\$14.75
	Rotor Replaces: #816774	
	B4003-059	\$22.50
	Cap Replaces: #816779, 822465, 1831800, 1853240	

*For 6-Volt Ignition Coils & Accessories, see p.44

Graham 6 Cylinder 1930 All Except Distributor #622Z, 623A, 623E, 623S, 632F, 632Z, 639K, 639W		
	B4100-001 PCR Kit Includes: Points (#B4001-001), Condenser (#B4002-001), Rotor (#B4004-002) Replaces: Points - #D100HP, 1855720 Condenser - #1928111, D-203, 1869704, D-200 Rotor - #820445, D400	\$10.50
	B4004-002 Rotor Replaces: #820445, D400	\$5.75
	B4003-002 Distributor Cap Premium Grade, Made in the USA (Brass Contacts) Replaces: #824735, D301	\$20.25
	B4007-001 Cap Clip Short Mount, 1 Used Replaces: #1889967, 1847289, 453844, 453461	\$11.95
	B4007-002 Cap Clip Long Mount, 1 Used Replaces: #1889967, 1889999, 453844, 453461	\$11.95
	B4008-001 Distributor Insulator Replaces: #1904376	\$14.99
	B4009-001 Distributor Bushing & Shim Kit	\$25.99
B4006-001	Dust Cover Replaces: #1900119	\$9.99

*For 6- or 12-Volt Ignition Coils & Accessories, see p.44



Graham 6 Cylinder 1930-1932 (With Distributor #622Z, 623A, 623E, 623S, 632F, 632Z, 639K, #639W), 1933-1942		
	B4001-021 Points Replaces: #1855520, D-109	\$13.75
	B4002-001 Condenser Replaces: #1928111, D-203, 1869704, D- 200	\$4.75

	B4004-021 Rotor Replaces: #816774	\$14.75
	B4003-059 Cap Replaces: #816779, 822465, 1831800, 1853240	\$22.50

*For 6-Volt Ignition Coils & Accessories, see p.44

Graham 8 Cylinder 1930-1932 All		
	B4002-001 Condenser Replaces#1928111, D-203, 1869704, D- 200	\$4.75
	B4003-028 Cap Top Quality USA Made With Brass Contacts Replaces: #1911556, D-302	\$26.25
	B4004-018 Rotor Replaces: #1836893	\$5.75
	B4007-001 Cap Clip Short Mount, 1 Used Replaces: #1889967, 1847289, 453844, 453461	\$11.95
	B4007-002 Cap Clip Long Mount, 1 Used Replaces: #1889967, 1889999, 453844, 453461	\$11.95
	B4009-001 Distributor Bushing & Shim Kit	\$25.99

*For 6-Volt Ignition Coils & Accessories, see p.44

Graham 8 Cylinder 1933-1935 All Except Super Charged		
	B4001-006 Points Replaces: #1882022	\$11.75
	B4002-001 Condenser Replaces: #1928111, D-203, 1869704, D- 200	\$4.75

	B4003-028	\$26.25
Cap Top Quality USA Made With Brass Contacts Replaces: #1911556, D-302		
	B4004-018	\$5.75
Rotor Replaces: #1836893		
	B4007-001	\$11.95
Cap Clip Short Mount, 1 Used Replaces: #1889967, 1847289, 453844, 453461		
	B4007-002	\$11.95
Cap Clip Long Mount, 1 Used Replaces: #1889967, 1889999, 453844, 453461		
	B4009-001	\$25.99
Distributor Bushing & Shim Kit		

*For 6-Volt Ignition Coils & Accessories, see p.44

ELECTRONIC IGNITION CONVERSION KITS

Replaces Points & Condenser



Graham-Paige 6 Cylinder 1929-1930 with Delco Distributor #623E		
B9600-309	12 Volt Negative Ground	\$154.95
B9600-309P6	6 Volt Positive Ground	\$169.45

Graham 6 Cylinder 1930 with Distributor #622Z, 623A, 623E, 623S, 632F, 632Z, 639K, 639W		
B9600-309	12 Volt Negative Ground	\$154.95
B9600-309P6	6 Volt Positive Ground	\$169.45

Graham 6 Cyl. 1930 (Except Distributor #632F, 639K, 639W)		
B9600-255LS	12 Volt Negative Ground	\$162.45
B9600-255LSP12	12 Volt Positive Ground	\$175.45
B9600-255LSP6	6 Volt Positive Ground	\$175.45





***For Ignition Coils & Accessories, see p.44**

CUTOUT RELAYS & VOLTAGE REGULATORS

Note: Due to modern battery design, voltage regulators can't be used to charge low or dead batteries. Doing so will destroy the voltage regulator and void the warranty.

B8001-001	6-Volt Cutout Relay	\$19.50
	15 Amps, 6 Volt Works Positive or Negative Ground Replaces: Autolite - CB4014, C4012(9-5), C4012(9-4), C4012(9-1), R40061 Delco - #266P, 266N, 265P, 265N, 5015850, 812970, 265J, 820845, 812971, 1116816, 265G, 265H, 1116755, 1116751, 1116809DR, 265B, 1842859, 265C, 1867781, 265F, 265D Fits: Graham - 6, 8 Cyl. All 1930-1942	

B8001-002	Electronic Cutout Relay	\$19.50
	25 Amp, Works with 6, 12, or 24 Volts. & Positive or Negative Ground Replaces: Autolite - #CB4014, C4012(9-5), C4012(9-4), C4012(9-1), R40061 Delco - #266P, 266N, 265P, 265N, 5015850, 812970, 265J, 820845, 812971, 1116816, 265G, 265H, 1116755, 1116751, 1116809DR, 265B, 1842859, 265C, 1867781, 265F, 265D Fits: Graham - 6, 8 Cyl. All 1930-1942	

6-Volt Saddle Mounted Cutout Relay (Delco Version)		
B8001-004	Premium Quality, Made in the USA	\$122.50
B8001-006	Standard Quality	\$38.59
	Cutout Relay, 25 Amp, 6 Volt, Works Positive or Negative Ground. Replaces: Delco - #266P, 266N, 265P, 265N, 5015850, 812970, 265J, 820845, 812971, 1116816, 265G, 265H, 1116755, 1116751, 1116809DR, 265B, 1842859, 265C, 1867781, 265F, 265D Fits: Graham - 6, 8 Cyl. 1930-1942	

6-Volt Delco Type Voltage Regulator		
B8002-001	Premium Quality, Made in the USA	\$87.75
B8002-042	Standard Quality	\$34.75
	6-Volt, 3-Terminal, 32-42 Amps, Negative Ground, Flat Mounting Bracket, A-Circuit Replaces: Delco - 1118201, 1118300, 1118301, 1118357, 1118364, 1118721, 1118843, 1118847, 1118869, 1118872, D601, D614, D653 Fits: Graham - 1934-1935, 8 Cyl	

IDENTIFICATION TAGS

B9013-003	Large Delco Remy I.D. Tag (Blank)	\$9.00
	Large Delco Remy I.D. Tag (Stamped)	\$16.25
		Large Black Delco-Remy I.D. Tag for Distributors, 6 Volt Starters, & 6 Volt Generators with Rivets, 1 1/4" X 2 7/8"
B9013-004	Delco Remy I.D. Tag (Blank)	\$7.00
	Delco Remy I.D. Tag (Stamped)	\$14.25
		Black Delco-Remy I.D. Tag for Distributors, 6 Volt Starters, & 6 Volt Generators with Rivets, 3/4" 2 5/16"
B9013-005	Red Delco Remy I.D. Tag (Blank)	\$7.00
	Red Delco Remy I.D. Tag (Stamped)	\$14.25
		Red Delco-Remy I.D. Tag for 12 Volt Starters & 12 Volt Generators with Rivets, 3/4" 2 5/16"
B9013-013	Delco Remy I.D. Tag (Blank)	\$7.00
	Delco Remy I.D. Tag (Stamped)	\$14.25
		Black Delco-Remy I.D. Tag for Distributors, 6 Volt Starters, & 6 Volt Generators with Rivets, 3/4" 2 5/16"

SWITCHES

B5010-018	Turn Signal Light Switch	\$73.50
		Universal Turn Signal Switch. Has right turn, left turn, and warning flasher modes. Metal Construction with Color Coded Wire Leads. Fuse, clamp ring, and instruction sheet included. Fits: Pre-1953

ALTERNATORS

B6001-001	12 Volt Alternator (1 Wire)	\$112.75	
63 Amp, Low Cut In, Specially Built For Tractors, Forklifts, & Other Low Engine Speed Applications			
B6001-005	6 Volt Alternator (1 Wire, Positive Ground)	\$166.50	
6 Volt, 40 Amp Alternator with Positive Ground, 1 Wire, 3/8" pulley			

HENRY J

For Spark Plug Wire Sets & Battery Cables, see Kaiser.

TUNE UP PARTS

Henry J 4 Cylinder Late 1952		
	B4001-013	\$16.25
	Points Replaces: #1938330 (D-103P), 1882024 (D103), 1871678, 1871870, 1918148	
	B4002-001	\$4.75
	Condenser Replaces: #1928111, D-203, 1869704, D-200	
	B4003-001	\$13.50
	Distributor Cap Premium Grade, Made in the USA (Brass Contacts) Replaces: #811735, D300	
	B4004-002	\$5.75
	Rotor Replaces: #820445, D400	

*For 6-Volt Ignition Coils & Accessories, see p.44

Henry J 6 Cylinder Late 1952		
	B4001-013	\$16.25
	Points Replaces: #1938330 (D-103P), 1882024 (D103), 1871678, 1871870, 1918148	
	B4002-001	\$4.75
	Condenser Replaces: #1928111, D-203, 1869704, D-200	
	B4004-002	\$5.75
	Rotor Replaces: #820445, D400	
	B4003-002	\$20.25
	Distributor Cap Premium Grade, Made in the USA (Brass Contacts) Replaces: #824735, D301	
B4006-001	Dust Cover	Replaces: #1900119 \$9.99

*For 6- or 12-Volt Ignition Coils & Accessories, see p.44

Henry J 4 Cylinder Early 1952		
	B4001-005	\$9.75
	Points Replaces: #1-4, 1-8, 1-9, 1-20, 1-22, 1-45, IAD-3128S, IGP-3028ES, IGP3028FS, IGS2224L, IGW3028AS	
	B4002-006	\$7.50
	Condenser Replaces: #2-31, 2-38, 2-42, 2-95, IAT-1125S, IAT-3076BS, IBB-2042SS-1, IBB-2042-SS3, IG-3927F, IG-3927G, IG-3927K, IG-3927R	
	B4003-053	\$16.00
	Cap Replaces: #IAT-1041, 3-5	
	B4004-025	\$6.75
	Rotor Replaces: #IAT-1016	



*For 6-Volt Ignition Coils & Accessories, see p.44

Henry J 6 Cylinder Early 1952		
	B4001-005	\$9.75
	Points Replaces: #1-4, 1-8, 1-9, 1-20, 1-22, 1-45, IAD-3128S, IGP-3028ES, IGP3028FS, IGS2224L, IGW3028AS	
B4002-002		\$4.75
	Condenser Replaces#2-23, 2-31, 2-32, 2-34, 2-38, 2-42, IAT-2015L, IAT-2015R, IAT-3076AS, IAT-3076BS, IAT-3076D, IAT-3076DS, IAT-3076L, IAT-3076LA, IAT-3076R, IAT-3076RA, IBB-2015L, IBB-2015R, IBB-2042-SS, IBB-2042SS-1, IBB-2042-SS3, IG-2671F, IGH-3076, IGW-3139, 2098058, 3420600	
	B4003-054	\$17.75
	Cap Replaces: #IAT-1003, 3-3	
	B4004-025	\$6.75
	Rotor Replaces: #IAT-1016	

*For 6-Volt Ignition Coils & Accessories, see p.44

VOLTAGE REGULATORS

Note: Due to modern battery design, voltage regulators can't be used to charge low or dead batteries. Doing so will destroy the voltage regulator and void the warranty.

B8002-028	6-Volt Autolite Type Voltage Regulator	\$158.60
	6 Volt, 3 Terminal, Flat Mounting Bracket Regulator (Premium Quality Made in the USA) Replaces: Prestolite - #8-117, 8-70, 8-74, GRX-761, VBE-6102A, VBE-6104A, VBO-4601F, VBO-4601K, VBO-4602B, VBO-4602R, VRB-4002C, VRP-4001A, VRP-4001B, VRP-4002D, VRP-4003A, VRP-4003B, VRP-4004A, VRP-4004C, VRP-4004F, VRP-4008A, VRP-6001A, VRP-6001B, VRP-6002A, VRP-6005A, VRP-6101A, VRP-6101B Fits: Henry J - 1951 to Early 1952	
	6-Volt Delco Type Voltage Regulator	
B8002-001	Premium Quality, Made in the USA	\$87.75
B8002-042	Standard Quality	\$34.75
	6-Volt, 3-Terminal, 32-42 Amps, Negative Ground, Flat Mounting Bracket, A-Circuit Replaces: Delco - 1118201, 1118300, 1118301, 1118357, 1118364, 1118721, 1118843, 1118847, 1118869, 1118872, D601, D614, D653	
	Fits: Henry J - Late 1952	

SWITCHES

B5010-018	Turn Signal Light Switch	\$73.50
	Universal Turn Signal Switch. Has right turn, left turn, and warning flasher modes. Metal Construction with Color Coded Wire Leads. Fuse, clamp ring, and instruction sheet included. Fits: Pre-1953 Vehicles	

ALTERNATORS

B6001-001	12 Volt Alternator (1 Wire)	\$112.75	
63 Amp, Low Cut In, Specially Built For Tractors, Forklifts, & Other Low Engine Speed Applications			
B6001-005	6 Volt Alternator (1 Wire, Positive Ground)	\$166.50	
6 Volt, 40 Amp Alternator with Positive Ground, 1 Wire, 3/8" pulley			

HUDSON CAR

TABLE OF CONTENTS

Spark Plug Wire Sets _____	492
Battery Cables _____	492
Tune Up Parts _____	493
Electronic Ignition Conversion Kits _____	495
Cutout Relays & Voltage Regulator _____	495
Identification Tags _____	496
Switches _____	496
Alternators _____	496

BATTERY CABLES



Our Battery Cables are made from the Proper Gauge Copper, as either Black Cotton Braided Wire or PVC Wire (whichever is correct for the application), using Soldered & Heat Sealed Brass or Copper Terminals.

Hudson Car 8 Cyl. 1934, 6 & 8 Cyl. 1935

B2000-005	Positive Ground Strap	\$12.50
B2078-001	Negative Battery Cable	\$45.25

Hudson Car 6 & 8 Cyl. 1936

B2000-005	Positive Ground Strap	\$12.50
B2078-003	Negative Battery Cable	\$41.50

Hudson Car 6 Cyl. 1937

B2000-008	Positive Ground Strap	\$15.50
B2078-005	Negative Battery Cable	\$45.25

Hudson Car 8 Cyl. 1937

B2078-006	Negative Battery Cable	\$32.00
-----------	------------------------	---------

Hudson Car 1938 Model 112

B2000-004	Positive Ground Strap	\$10.50
-----------	-----------------------	---------

Hudson Car 6 & 8 Cyl. 1938

B2078-007	Negative Battery Cable	\$45.25
-----------	------------------------	---------

Hudson Car 6 Cyl. 1939

B2000-006	Positive Ground Strap	\$13.50
-----------	-----------------------	---------

Hudson Car 6 Cyl. 1939

Country Club

B2000-006	Positive Ground Strap	\$13.50
B2078-008	Negative Battery Cable	\$45.25

Hudson Car 6 Cyl. 1940-1941

10 & 40

B2000-004	Positive Ground Strap	\$10.50
B2078-009	Negative Battery Cable	\$45.25

Hudson Car 6 Cyl. 1940-1941

11, 12, 41 & 43

B2000-004	Positive Ground Strap	\$10.50
B2078-010	Negative Battery Cable	\$47.75

Hudson Car 6 Cyl. 1942

(Except Series 20)

B2000-004	Positive Ground Strap	\$10.50
B2078-010	Negative Battery Cable	\$47.75

SPARK PLUG WIRE SETS

Our Spark Plug Wire Sets Come Fully Assembled with the Proper Type Wire & Terminals.

They are Custom Tailored to Look & Fit Like Original Factory Equipment.

Varieties include:

Cotton Braid Wire: Copper Core with a Cotton Jacket.

EPDM Wire (E): Hi Performance Premium Conductor with a Tinned Copper Core, EPDM Insulation, Rubber Jacket.

Suppression Wire (S): for Electronic Ignition and is Spiral Wound, Low-Ohm, with EPDM Silicone Insulation and a Rubber Jacket.

Cotton Braid Suppression Wire (CS): also for Electronic Ignition, as Suppression Wire, but has an additional layer of Cotton Braid & Lacquer to replicate the vintage look, as well..



Hudson 1940-1948 (6-Cylinder)

6 Cyl. Tailored Spark Plug Wire Set

B1078-001	Original Type Cotton Braid Wire	\$50.75
B1078-001E	EPDM Wire	\$55.50
B1078-001S	Suppression Wire	\$55.50
B1078-001CS	Cotton Suppression Wire	\$87.50

Hudson 1949-1952 (Except Jet)

6 Cyl. Tailored Spark Plug Wire Set

B1078-002	Original Type Cotton Braid Wire	\$50.75
B1078-002E	EPDM Wire	\$55.50
B1078-002S	Suppression Wire	\$55.50
B1078-002CS	Cotton Suppression Wire	\$87.50

Hudson 1953-1955

6 Cyl. Tailored Spark Plug Wire Set

B1078-003	Original Type Cotton Braid Wire	\$50.75
B1078-003E	EPDM Wire	\$55.50
B1078-003S	Suppression Wire	\$55.50
B1078-003CS	Cotton Suppression Wire	\$87.50

Hudson 1940-1952 (8-Cylinder)

6 Cyl. Tailored Spark Plug Wire Set

B1078-004	Original Type Cotton Braid Wire	\$68.00
B1078-004E	EPDM Wire	\$74.00
B1078-004S	Suppression Wire	\$74.00

Hudson Car 6 Cyl. 1942-1947

Series 20

B2000-004	Positive Ground Strap	\$10.50
B2078-012	Negative Battery Cable	\$35.25

Hudson Car 6 Cyl. 1942-1947

(Except Series 20)

B2000-004	Positive Ground Strap	\$10.50
B2078-013	Negative Battery Cable	\$45.25

Hudson Car 8 Cyl. 1942-1947

B2000-004	Positive Ground Strap	\$10.50
B2078-014	Negative Battery Cable	\$50.00

Hudson Car 6 & 8 Cyl. 1948-1950

B2000-006	Positive Ground Strap	\$13.50
B2078-015	Negative Battery Cable	\$42.25

Hudson Car 6 Cyl. 1951-1954

(Except Jet with Standard)

B2000-006	Positive Ground Strap	\$13.50
B2078-017	Negative Battery Cable	\$28.75
B2078-018	Switch to Starter Cable	\$38.00

Hudson Car 6 Cyl. 1951-1952

with Hydromatic

B2000-006	Positive Ground Strap	\$13.50
B2078-019	Negative Battery Cable	\$28.75
B2078-020	Switch to Starter Cable	\$35.00

Hudson Car 6 Cyl. 1951-1954

Hornet with Standard

B2000-006	Positive Ground Strap	\$13.50
B2078-019	Negative Battery Cable	\$28.75
B2078-020	Switch to Starter Cable	\$35.00

Hudson Car 8 Cyl. 1951-1952

B2000-006	Positive Ground Strap	\$13.50
B2078-019	Negative Battery Cable	\$28.75
B2078-020	Switch to Starter Cable	\$35.00

Hudson Car 6 Cyl. 1953-1954 Jet

B2000-007	Positive Ground Strap	\$14.50
B2078-025	Negative Battery Cable	\$31.00
B2078-026	Switch to Starter Cable	\$29.50

Hudson Car 8 Cyl. Rambler 1955

B2078-027	Positive Battery Cable	\$30.25
B2078-028	Negative Battery Cable	\$45.25

Hudson Car 8 Cyl. Rambler Deluxe 1955

B2078-029	Positive Battery Cable	\$30.25
B2078-030	Negative Battery Cable	\$33.50

TUNE UP PARTS

Hudson 6 Cylinder 1930-1932

B4002-002	\$4.75
------------------	---------------



Condenser

Replaces: #2-23, 2-31, 2-32, 2-34, 2-38, 2-42, IAT-2015L, IAT-2015R, IAT-3076AS, IAT-3076BS, IAT-3076D, IAT-3076DS, IAT-3076L, IAT-3076LA, IAT-3076R, IAT-3076RA, IBB-2015L, IBB-2015R, IBB-2042-SS, IBB-2042SS-1, IBB-2042-SS3, IG-2671F, IGH-3076, IGW-3139, 2098058, 3420600

*For 6-Volt Ignition Coils & Accessories, see p.44

Hudson 6 Cylinder 1933-1934

B4001-002	\$14.75
------------------	----------------



Points

Replaces: #IGW-3028S, 1-31

B4002-002	\$4.75
------------------	---------------



Condenser

Replaces: #2-23, 2-31, 2-32, 2-34, 2-38, 2-42, IAT-2015L, IAT-2015R, IAT-3076AS, IAT-3076BS, IAT-3076D, IAT-3076DS, IAT-3076L, IAT-3076LA, IAT-3076R, IAT-3076RA, IBB-2015L, IBB-2015R, IBB-2042-SS, IBB-2042SS-1, IBB-2042-SS3, IG-2671F, IGH-3076, IGW-3139, 2098058, 3420600

*For 6-Volt Ignition Coils & Accessories, see p.44

Hudson 6 Cylinder 1935-1947

B4001-002	\$14.75
------------------	----------------



Points

Replaces: #IGW-3028S, 1-31

B4002-002	\$4.75
------------------	---------------



Condenser

Replaces: #2-23, 2-31, 2-32, 2-34, 2-38, 2-42, IAT-2015L, IAT-2015R, IAT-3076AS, IAT-3076BS, IAT-3076D, IAT-3076DS, IAT-3076L, IAT-3076LA, IAT-3076R, IAT-3076RA, IBB-2015L, IBB-2015R, IBB-2042-SS, IBB-2042SS-1, IBB-2042-SS3, IG-2671F, IGH-3076, IGW-3139, 2098058, 3420600

B4003-027	\$21.75
------------------	----------------



Cap

Replaces: #ICB-1240, 3-20

B4004-004	\$11.50
------------------	----------------



Rotor

Premium Grade, Made in the USA
Replaces: #4-15, IGB-1239

*For 6-Volt Ignition Coils & Accessories, see p.44

Hudson 6 Cylinder 1948-1950 (All Except 1950 Series 500)		
	B4001-005	\$9.75
	Points Replaces: #1-4, 1-8, 1-9, 1-20, 1-22, 1-45, IAD-3128S, IGP-3028ES, IGP3028FS, IGS2224L, IGW3028AS	
	B4002-006	\$7.50
	Condenser Replaces: #2-31, 2-38, 2-42, 2-95, IAT-1125S, IAT-3076BS, IBB-2042SS-1, IBB-2042-SS3, IG-3927F, IG-3927G, IG-3927K, IG-3927R	
	B4004-007	\$8.25
	Rotor Premium Grade, Made in the USA Replaces: #4-19	
	B4003-007	\$15.50
	Distributor Cap Premium Grade, Made in the USA (Brass Contacts) Replaces: #IGC-1107S, 3-23	

*For 6-Volt Ignition Coils & Accessories, see p.44



Hudson 6 Cylinder 1950 (Series 500)		
	B4001-022	\$16.75
	Points Replaces: #IGS-2224, 1-44, 2084075	
	B4002-002	\$4.75
	Condenser Replaces: #2-23, 2-31, 2-32, 2-34, 2-38, 2-42, IAT-2015L, IAT-2015R, IAT-3076AS, IAT-3076BS, IAT-3076D, IAT-3076DS, IAT-3076L, IAT-3076LA, IAT-3076R, IAT-3076RA, IBB-2015L, IBB-2015R, IBB-2042-SS, IBB-2042SS-1, IBB-2042-SS3, IG-2671F, IGH-3076, IGW-3139, 2098058, 3420600	
	B4003-054	\$17.75
	Cap Replaces: #IAT-1003, 3-3	
	B4004-025	\$6.75
	Rotor Replaces: #IAT-1016	

*For 6-Volt Ignition Coils & Accessories, see p.44

Hudson 6 Cylinder 1951-1954 (Except IAT4207 Distributor)		
	B4001-022	\$16.75
	Points Replaces: #IGS-2224, 1-44, 2084075	
	B4002-002	\$4.75
	Condenser Replaces: #2-23, 2-31, 2-32, 2-34, 2-38, 2-42, IAT-2015L, IAT-2015R, IAT-3076AS, IAT-3076BS, IAT-3076D, IAT-3076DS, IAT-3076L, IAT-3076LA, IAT-3076R, IAT-3076RA, IBB-2015L, IBB-2015R, IBB-2042-SS, IBB-2042SS-1, IBB-2042-SS3, IG-2671F, IGH-3076, IGW-3139, 2098058, 3420600	
	B4003-036	\$13.50
	Cap Replaces: #IAT-1033, IAT-1033A, IAT-1033C, 3-4, 3-34, 3-37	
	B4004-034	\$4.25
	Rotor Replaces: #IAT-1016A, 4-2	

*For 6-Volt Ignition Coils & Accessories, see p.44

Hudson 6 Cylinder 1955 (Rambler)		
	B4100-001	\$10.50
	PCR Kit Includes: Points (#B4001-001), Condenser (#B4002-001), Rotor (#B4004-002) Replaces: Points - #D100HP, 1855720 Condenser - #1928111, D-203, 1869704, D-200 Rotor - #820445, D400	
	B4004-002	\$5.75
	Rotor Replaces: #820445, D400	
	B4003-002	\$20.25
	Distributor Cap Premium Grade, Made in the USA (Brass Contacts) Replaces: #824735, D301	
	B4007-001	\$11.95
	Cap Clip Short Mount, 1 Used Replaces: #1889967, 1847289, 453844, 453461	
	B4007-002	\$11.95
	Cap Clip Long Mount, 1 Used Replaces: #1889967, 1889999, 453844, 453461	

	B4008-001	\$14.99
	Distributor Insulator Replaces: #1904376	
	B4009-001	\$25.99
	Distributor Bushing & Shim Kit	
B4006-001	Dust Cover	Replaces: #1900119 \$9.99

*For 6- or 12-Volt Ignition Coils & Accessories, see p.44

Hudson 6 Cylinder 1955-1956 (Hornet & Wasp)

	B4001-022	\$16.75
	Points Replaces: #IGS-2224, 1-44, 2084075	

B4002-002	\$4.75
------------------	---------------

	Condenser Replaces: #2-23, 2-31, 2-32, 2-34, 2-38, 2-42, IAT-2015L, IAT-2015R, IAT-3076AS, IAT-3076BS, IAT-3076D, IAT-3076DS, IAT-3076L, IAT-3076LA, IAT-3076R, IAT-3076RA, IBB-2015L, IBB-2015R, IBB-2042-SS, IBB-2042SS-1, IBB-2042-SS3, IG-2671F, IGH-3076, IGW-3139, 2098058, 3420600
---	--

	B4003-036	\$13.50
	Cap Replaces: #IAT-1033, IAT-1033A, IAT-1033C, 3-4, 3-34, 3-37	

	B4004-034	\$4.25
	Rotor Replaces: #IAT-1016A, 4-2	

*For 12-Volt Ignition Coils & Accessories, see p.44



***For Ignition Coils & Accessories, see p.44**

ELECTRONIC IGNITION CONVERSION KITS

Replaces Points & Condenser



Hudson 6 Cyl. 1948-1950 All with Autolite IGS Series Distributor

B9600-307LS	12 Volt Negative Ground	\$169.45
B9600-307LSP6	6 Volt Positive Ground	\$185.95

Hudson 6 Cyl. 1955 (Rambler)

B9600-255LS	12 Volt Negative Ground	\$162.45
B9600-255LSP12	12 Volt Positive Ground	\$175.45
B9600-255LSP6	6 Volt Positive Ground	\$175.45

CUTOUT RELAYS & VOLTAGE REGULATORS

Note: Due to modern battery design, voltage regulators can't be used to charge low or dead batteries. Doing so will destroy the voltage regulator and void the warranty.

B8001-001	6-Volt Cutout Relay	\$19.50
------------------	----------------------------	----------------

	15 Amps, 6 Volt Works Positive or Negative Ground Replaces: Autolite - #CB4014, C4012(9-5), C4012(9-4), C4012(9-1), R40061 Delco - #266P, 266N, 265P, 265N, 5015850, 812970, 265J, 820845, 812971, 1116816, 265G, 265H, 1116755, 1116751, 1116809DR, 265B, 1842859, 265C, 1867781, 265F, 265D Fits: Hudson - 1930-1933
--	---

B8001-002	Electronic Cutout Relay	\$19.50
------------------	--------------------------------	----------------

	25 Amp, Works with 6, 12, or 24 Volts, Positive or Negative Ground Replaces: Autolite - #CB4014, C4012(9-5), C4012(9-4), C4012(9-1), R40061 Delco - #266P, 266N, 265P, 265N, 5015850, 812970, 265J, 820845, 812971, 1116816, 265G, 265H, 1116755, 1116751, 1116809DR, 265B, 1842859, 265C, 1867781, 265F, 265D Fits: Hudson - 1930-1933
--	--

B8002-028	6-Volt Autolite Type Voltage Regulator	\$158.60
 <p>6 Volt, 3 Terminal, Flat Mounting Bracket Regulator (Premium Quality Made in the USA) Replaces: Prestolite - #8-117, 8-70, 8-74, GRX-761, VBE-6102A, VBE-6104A, VBO-4601F, VBO-4601K, VBO-4602B, VBO-4602R, VRB-4002C, VRP-4001A, VRP-4001B, VRP-4002D, VRP-4003A, VRP-4003B, VRP-4004A, VRP-4004C, VRP-4004F, VRP-4008A, VRP-6001A, VRP-6001B, VRP-6002A, VRP-6005A, VRP-6101A, VRP-6101B Chrysler - #1120515, 1121978, 1257394, 1321757, 1343573, 1571161, 2095209, 871763 Fits: Hudson - 1948 to 1950</p>		

B8002-031	6-Volt Autolite Type Voltage Regulator	\$144.88
 <p>6 Volt, 3 Terminal, Flat Mounting Bracket Regulator. Positive Ground. (Premium Quality Made in the USA) Replaces: Chrysler - #1311467, 1343753, 1502074, 1641510 Delco - #A602, A602M Prestolite - #8-76, 8-762, VBE-6001A, VBE-6101, VBE-6201A, VBO-4602E, VBO-4602V Fits: Hudson - 6 Cyl. 1953-1955 (All with GGW Generator), 8 Cyl. 1953-1955 (All with GGW Generator)</p>		

B8002-008	12-Volt Autolite Type Voltage Regulator	\$69.75
 <p>12 Volt, 3 Terminal, Flat Mounting (Premium Quality, Made in the USA) Replaces: Prestolite - #8-154, 8-414, 8-58, 8-59, 8-722, 8-85, GRX-722, VBO-4201E, VBO-4202A, VBO-4202B, VBO-4202P, VBO-4202R, VR-6301A, VRX-6010, VRX-6010A Chrysler - #1642333, 1842798, 1889944, 2095341, 2095531 Delco - #1972029, 1972061, A600, A600M, A605, A605M Fits: Hudson - 1956 w/ Autolite Generator</p>		

B9013-002	Large Autolite I.D. Tag (Blank)	\$7.00
	Large Autolite I.D. Tag (Stamped)	\$14.25
		2 15/16" Long, Black I.D. Tag for Distributors, Starters, & Generators with Rivets

SWITCHES

B5010-018	Turn Signal Light Switch	\$73.50
		Universal Turn Signal Switch. Has right turn, left turn, and warning flasher modes. Metal Construction with Color Coded Wire Leads. Fuse, clamp ring, and instruction sheet included. Fits: Pre-1953 Vehicles

ALTERNATORS

Delco 10SI Type



B6001-001	12 Volt Alternator (1 Wire)	\$112.75
63 Amp, Low Cut In, Specially Built For Tractors, Forklifts, & Other Low Engine Speed Applications		
B6001-005	6 Volt Alternator (1 Wire, Positive Ground)	\$166.50
6 Volt, 40 Amp Alternator with Positive Ground, 1 Wire, 3/8" pulley		

HUDSON TRUCK

SPARK PLUG WIRE SETS

Hudson Truck 1946

6 Cyl. Tailored Spark Plug Wire Set

B1079-001	Original Type Cotton Braid Wire	\$61.75
B1079-001E	EPDM Wire	\$67.25

IDENTIFICATION TAGS

B9013-001	Small Autolite I.D. Tag (Blank)	\$7.00
	Small Autolite I.D. Tag (Stamped)	\$14.25
		2 5/16" Long, Black I.D. Tag for Distributors, Starters, & Generators with Rivets

HUPMOBILE

SPARK PLUG WIRE SETS

Our Spark Plug Wire Sets Come **Fully Assembled with the Proper Type Wire & Terminals.**

They are Custom Tailored to Look & Fit Like Original Factory Equipment.



Hupmobile Model M

8 Cyl. Tailored Spark Plug Wire Set

B1114-001	Original Type Cotton Braid Wire	\$114.25
B1114-001E	EPDM Wire	\$124.75

BATTERY CABLES



Our Battery Cables are made from the Proper Gauge Copper, as either **Black Cotton Braided Wire or PVC Wire** (whichever is correct for the application), using Soldered & Heat Sealed Brass or Copper Terminals.

Hupmobile1933 F-322

B2114-001	Negative Battery Cable	\$52.00
------------------	------------------------	----------------

Hupmobile1934 416

B2000-005	Positive Ground Strap	\$12.50
------------------	-----------------------	----------------

Hupmobile 1937-39

B2000-005	Positive Ground Strap	\$12.50
------------------	-----------------------	----------------

TUNE UP PARTS

Hupmobile 6 Cylinder 1935-1936

	B4001-002 Points Replaces: #IGW-3028S, 1-31	\$14.75
	B4002-005 Condenser Replaces: #2-24, 2-35, 2-22, 2-23	\$9.75
	B4003-027 Cap Replaces: #ICB-1240, 3-20	\$21.75

	B4004-004 Rotor Premium Grade, Made in the USA Replaces: #4-15, IGB-1239	\$11.50
--	---	----------------

*For 6-Volt Ignition Coils & Accessories, see p.44

Hupmobile 6 Cylinder 1938-1939

	B4001-002 Points Replaces: #IGW-3028S, 1-31	\$14.75
--	---	----------------

B4002-002 \$4.75

	Condenser Replaces: #2-23, 2-31, 2-32, 2-34, 2-38, 2-42, IAT-2015L, IAT-2015R, IAT-3076AS, IAT-3076BS, IAT-3076D, IAT-3076DS, IAT-3076L, IAT-3076LA, IAT-3076R, IAT-3076RA, IBB-2015L, IBB-2015R, IBB-2042-SS, IBB-2042SS-1, IBB-2042-SS3, IG-2671F, IGH-3076, IGW-3139, 2098058, 3420600	
---	---	--

*For 6-Volt Ignition Coils & Accessories, see p.44

Hupmobile 6 Cylinder 1940

	B4001-002 Points Replaces: #IGW-3028S, 1-31	\$14.75
---	---	----------------

	B4002-005 Condenser Replaces: #2-24, 2-35, 2-22, 2-23	\$9.75
---	---	---------------

	B4003-027 Cap Replaces: #ICB-1240, 3-20	\$21.75
---	---	----------------

	B4004-004 Rotor Premium Grade, Made in the USA Replaces: #4-15, IGB-1239	\$11.50
--	---	----------------

*For 6-Volt Ignition Coils & Accessories, see p.44

Hupmobile 8 Cylinder 1932-1939

	B4001-002 Points Replaces: #IGW-3028S, 1-31	\$14.75
--	---	----------------

*For 6-Volt Ignition Coils & Accessories, see p.44

ELECTRONIC IGNITION CONVERSION KITS

Replaces Points & Condenser



Hupmobile 6 Cyl. 1929-1939 with Autolite Distributor # IGC-4729A

B9600-070A	12 Volt Negative Ground	\$195.95
B9600-070AP6	6 Volt Positive Ground	\$206.45

CUTOUT RELAYS & VOLTAGE REGULATORS

Note: Due to modern battery design, voltage regulators can't be used to charge low or dead batteries. Doing so will destroy the voltage regulator and void the warranty.

B8001-001 6-Volt Cutout Relay \$19.50



15 Amps, 6 Volt Works Positive or Negative Ground
Replaces:

Autolite - #CB4014, C4012(9-5), C4012(9-4), C4012(9-1), R40061
Delco - #266P, 266N, 265P, 265N, 5015850, 812970, 265J, 820845, 812971,

1116816, 265G, 265H, 1116755, 1116751, 1116809DR, 265B, 1842859, 265C, 1867781, 265F, 265D

Fits: **Hupmobile** - 1930-1937

B8001-002 Electronic Cutout Relay \$19.50



25 Amp, Works with 6, 12, or 24 Volts. & Positive or Negative Ground
Replaces:

Autolite - #CB4014, C4012(9-5), C4012(9-4), C4012(9-1), R40061
Delco - #266P, 266N, 265P, 265N, 5015850, 812970, 265J, 820845, 812971,

1116816, 265G, 265H, 1116755, 1116751, 1116809DR, 265B, 1842859, 265C, 1867781, 265F, 265D

Fits: **Hupmobile** - 1930-1937

6-Volt Saddle Mounted Cutout Relay (Delco Version)

B8001-004 Premium Quality, Made in the USA \$122.50

B8001-006 Standard Quality \$38.59



Cutout Relay, 25 Amp, 6 Volt, Works Positive or Negative Ground.
Replaces:

Delco - #266P, 266N, 265P, 265N, 5015850, 812970, 265J, 820845, 812971, 1116816, 265G, 265H, 1116755, 1116751, 1116809DR, 265B, 1842859, 265C,

1867781, 265F, 265D

Fits: **Hupmobile** - 1930-1937

IDENTIFICATION TAGS

B9013-001	Small Autolite I.D. Tag (Blank)	\$7.00
	Small Autolite I.D. Tag (Stamped)	\$14.25
		2 5/16" Long, Black I.D. Tag for Distributors, Starters, & Generators with Rivets
B9013-002	Large Autolite I.D. Tag (Blank)	\$7.00
	Large Autolite I.D. Tag (Stamped)	\$14.25
		2 15/16" Long, Black I.D. Tag for Distributors, Starters, & Generators with Rivets

SWITCHES

B5010-018	Turn Signal Light Switch \$73.50
	Universal Turn Signal Switch. Has right turn, left turn, and warning flasher modes. Metal Construction with Color Coded Wire Leads. Fuse, clamp ring, and instruction sheet included. Fits: Pre-1953 Vehicles

ALTERNATORS

Delco 10SI Type



B6001-001	12 Volt Alternator (1 Wire) \$112.75
63 Amp, Low Cut In, Specially Built For Tractors, Forklifts, & Other Low Engine Speed Applications	
B6001-005	6 Volt Alternator \$166.50 (1 Wire, Positive Ground)
6 Volt, 40 Amp Alternator with Positive Ground, 1 Wire, 3/8" pulley	

INTERNATIONAL HARVESTER TRUCK

TABLE OF CONTENTS

Spark Plug Wire Sets	499
Battery Cables	499
Wiring Harnesses	500
Tune Up Parts	500
Electronic Ignition Conversion Kit	502
Cutout Relays & Voltage Regulator	503
Identification Tags	504
Alternators	504
Switches	504

SPARK PLUG WIRE SETS

Our Spark Plug Wire Sets Come Fully Assembled with the Proper Type Wire & Terminals.

They are Custom Tailored to Look & Fit Like Original Factory Equipment.

Varieties include:

Cotton Braid Wire: Copper Core with a Cotton Jacket.

EPDM Wire (E): Hi Performance Premium Conductor with a Tinned Copper Core, EPDM Insulation, Rubber Jacket.

Suppression Wire (S): for Electronic Ignition and is Spiral Wound, Low-Ohm, with EPDM Silicone Insulation and a Rubber Jacket.

Cotton Braid Suppression Wire (CS): also for Electronic Ignition, as Suppression Wire, but has an additional layer of Cotton Braid & Lacquer to replicate the vintage look, as well.



International Harvester Truck 1923-1927

4 Cyl. Tailored Spark Plug Wire Set

B1081-001	Original Type Cotton Braid Wire	\$41.25
B1081-001E	EPDM Wire	\$45.25

International Harvester Truck 1927-1931

6-Speed Special, 4 Cyl. Tailored Spark Plug Wire Set

B1081-002	Original Type Cotton Braid Wire	\$41.25
B1081-002E	EPDM Wire	\$45.25
B1081-002S	Suppression Wire	\$45.25
B1081-002CS	Cotton Suppression Wire	\$71.25

International Harvester Truck 1937-1941 D2, 1941-1946 K1-K5, & 1947-1949 KB1-KB5

6 Cyl. Tailored Spark Plug Wire Set

B1081-005	Original Type Cotton Braid Wire	\$50.75
B1081-005E	EPDM Wire	\$55.50
B1081-005S	Suppression Wire	\$55.50
B1081-005CS	Cotton Suppression Wire	\$87.50

International Harvester Truck Green Diamond 233 (1934-1949)

6 Cyl. Tailored Spark Plug Wire Set

B1081-003	Original Type Cotton Braid Wire	\$50.75
B1081-003E	EPDM Wire	\$55.50
B1081-003S	Suppression Wire	\$55.50
B1081-003CS	Cotton Suppression Wire	\$87.50

International Harvester Truck Blue Diamond 269 (1941-1954)

Fits K6 1941-1946, KB6 1947-1949 & Others

6 Cyl. Tailored Spark Plug Wire Set

B1081-008	Original Type Cotton Braid Wire	\$50.75
B1081-008E	EPDM Wire	\$55.50
B1081-008S	Suppression Wire	\$55.50
B1081-008CS	Cotton Suppression Wire	\$87.50

International Harvester Truck Red Diamond 450 & 501 (1941-1974)

6 Cyl. Tailored Spark Plug Wire Set

B1081-004	Original Type EPDM Wire	\$46.00
------------------	-------------------------	---------

International Harvester Truck Silver Diamond (1949-1969)

6 Cyl. Tailored Spark Plug Wire Set

B1081-007	Original Type Cotton Braid Wire	\$50.75
B1081-007E	EPDM Wire	\$55.50
B1081-007S	Suppression Wire	\$55.50
B1081-007CS	Cotton Suppression Wire	\$87.50

International Harvester Truck Black Diamond 308 (1960-1965)

6 Cyl. Tailored Spark Plug Wire Set

B1081-006	Original Type EPDM Wire	\$46.00
------------------	-------------------------	---------

1965-1977 International Harvester Truck

with 478", 549" Engines and Holley Distr. #469620C91

8 Cyl. Tailored Spark Plug Wire Set

B1081-009	Original Type EPDM Wire	\$74.00
B1081-009S	Suppression Wire	\$74.00

BATTERY CABLES



Our Battery Cables are made from the Proper Gauge Copper, as either Black Cotton Braided Wire or PVC Wire (whichever is correct for the application), using Soldered & Heat Sealed Brass or Copper Terminals.

6 Cyl. IHC Truck 1927

B2000-006	Positive Ground Strap	\$13.50
B2081-001	Negative Battery Cable	\$69.50

1948 KB-1 IHC Truck

B2081-002	Negative Battery Cable	\$38.50
------------------	------------------------	---------



WIRING HARNESSSES

Our Wire Harnesses are made with our **premium cotton braid and/or PVC wire**.

They have the **correct gauge, color, wire, & fuse holders** (if needed).

All terminals are **soldered according to the original**.

(Harnesses do not include Battery Cables & Spark Plug Wires; however, we can supply these as separate products.)

NO HIDDEN COSTS, NOTHING EXTRA TO BUY!

International Harvester Truck 1927-1931 Six Speed Special

B3081-002	Complete Wire Harness Original Design with Generator & Cutout Relay		\$250.25
------------------	---	--	-----------------

International Harvester Truck 1941-1946 (K1-K5), 1947-1949 (KB1-KB5)

B3081-001	Complete Wire Harness for Short Box Trucks 6 1/2' Box (not modified for turn signals) Original Design with Generator & Voltage Regulator		\$623.25
B3081-005	30" Extension for Long Box Truck (9' Box)	Used with B3081-001 , above	\$37.00
B3081-003	Complete Wire Harness for Short Box Trucks 6 1/2' Box, Modified for Turn Signals Original Design with Generator & Voltage Regulator		\$774.50
B3081-004	30" Extension for Long Box Truck (9' Box), Modified for Turn Signals	Used with B3081-003 , above	\$55.50

TUNE UP PARTS

4-Cylinder

<u>International Harvester Truck</u>		
4 Cylinder 1923-1931 with Delco Distributor #629T, 635J		
	B4001-021	\$13.75
	Points Replaces: #1855520, D-109	
	B4002-001	\$4.75
	Condenser Replaces #1928111, D-203, 1869704, D-200	
	B4004-021	\$14.75
	Rotor Replaces: #816774	
	B4003-033	\$25.50
	Cap Replaces: #811589, 1835536, 821589, 818425	

*For 6-Volt Ignition Coils & Accessories, see p.44

<u>International Harvester Truck</u>		
4 Cylinder 1964-1965 (All), 1968 (Early with Holley Distributor)		
	B4001-010	\$4.75
	Points Replaces: #FAA-12171A (DP-3), 7RA-12171 (DP-7)	
	B4002-014	\$7.50
	Condenser Replaces: #86D-139A, 86D-140A	
	B4003-055	\$9.75
	Cap Replaces: #268575C92	
	B4004-035	\$6.25
	Rotor Replaces: #268574C92	

*For 12-Volt Ignition Coils & Accessories, see p.44



International Harvester Truck		
4 Cylinder 1968-1975 (All with Holley Distributor, & Curved Points)		
	B4001-031	\$17.25
Points Replaces: #361764C1, 76D-711A		
	B4002-014	\$7.50
Condenser Replaces: #86D-139A, 86D-140A		
	B4003-055	\$9.75
Cap Replaces: #268575C92		
	B4004-035	\$6.25
Rotor Replaces: #268574C92		

*For 12-Volt Ignition Coils & Accessories, see p.44



6-Cylinder

International Harvester Truck		
6 Cylinder 1928-1941 C & D Models (With Delco Distributor #622R, 623G, 639T)		
	B4001-021	\$13.75
Points Replaces: #1855520, D-109		
	B4002-001	\$4.75
Condenser Replaces: #1928111, D-203, 1869704, D-200		
	B4004-021	\$14.75
Rotor Replaces: #816774		
	B4003-059	\$22.50
Cap Replaces: #816779, 822465, 1831800, 1853240		

*For 6-Volt Ignition Coils & Accessories, see p.44

International Harvester Truck		
6 Cylinder 1946 (with Autolite Distributor)		
	B4001-002	\$14.75
Points Replaces: #IGW-3028S, 1-31		
	B4002-002	\$4.75
Condenser Replaces: #2-23, 2-31, 2-32, 2-34, 2-38, 2-42, IAT-2015L, IAT-2015R, IAT-3076AS, IAT-3076BS, IAT-3076D, IAT-3076DS, IAT-3076L, IAT-3076LA, IAT-3076R, IAT-3076RA, IBB-2015L, IBB-2015R, IBB-2042-SS, IBB-2042SS-1, IBB-2042-SS3, IG-2671F, IGH-3076, IGW-3139, 2098058, 3420600		

International Harvester Truck		
6 Cylinder 1946-1956 (with Delco Distributor #1110104 & Others), 1957 (All)		
	B4100-001	\$10.50
PCR Kit Includes: Points (#B4001-001), Condenser (#B4002-001), Rotor (#B4004-002) Replaces: Points - #D100HP, 1855720 Condenser - #1928111, D-203, 1869704, D-200 Rotor - #820445, D400		
	B4004-002	\$5.75
Rotor Replaces: #820445, D400		
	B4003-002	\$20.25
Distributor Cap Premium Grade, Made in the USA (Brass Contacts) Replaces: #824735, D301		
B4006-001	Dust Cover	Replaces: #1900119 \$9.99

International Harvester Truck		
6 Cylinder 1959-1961 (All), 1962-1969 (With Delco Distributor)		
	B4001-013	\$16.25
Points Replaces: #1938330 (D-103P), 1882024 (D103), 1871678, 1871870, 1918148		
	B4002-001	\$4.75
Condenser Replaces: #1928111, D-203, 1869704, D-200		
	B4004-002	\$5.75
Rotor Replaces: #820445, D400		

	B4003-002	\$20.25
	Distributor Cap Premium Grade, Made in the USA (Brass Contacts) Replaces: #824735, D301	
	B4007-001	\$11.95
	Cap Clip Short Mount, 1 Used Replaces: #1889967, 1847289, 453844, 453461	
	B4007-002	\$11.95
	Cap Clip Long Mount, 1 Used Replaces: #1889967, 1889999, 453844, 453461	
	B4008-001	\$14.99
	Distributor Insulator Replaces: #1904376	
	B4009-001	\$25.99
	Distributor Bushing & Shim Kit	
B4006-001	Dust Cover	Replaces: #1900119 \$9.99

*For 6- or 12-Volt Ignition Coils & Accessories, see p.44

International Harvester Truck 6 Cylinder 1958-1969		
	B4100-001	\$10.50
	PCR Kit Includes: Points (#B4001-001), Condenser (#B4002-001), Rotor (#B4004-002) Replaces: Points - #D100HP, 1855720 Condenser - #1928111, D-203, 1869704, D-200 Rotor - #820445, D400	
	B4003-034	\$18.25
	Cap Replaces: #268574C92	
	B4004-002	\$5.75
	Rotor Replaces: #820445, D400	

*For 6- or 12-Volt Ignition Coils & Accessories, see p.44

8-Cylinder

International Harvester Truck 8 Cylinder 1963-1979 All (with Prestolite #IDN-4102, IDN-4103G, IDN-4109 Distributors)		
	B4002-006	\$7.50
	Condenser Replaces: #2-31, 2-38, 2-42, 2-95, IAT-1125S, IAT-3076BS, IBB-2042SS-1, IBB-2042-SS3, IG-3927F, IG-3927G, IG-3927K, IG-3927R	
	B4003-067	\$19.75
	Cap Replaces: #AL482, 3-140	
	B4004-041	\$7.75
	Rotor Replaces: #4-95, 4-98, 493070C1	

*For 12-Volt Ignition Coils & Accessories, see p.44

ELECTRONIC IGNITION CONVERSION KITS

Replaces Points & Condenser



International Harvester Truck 4 Cyl. 1928-1941 with Delco 625F, 629K, 629T, 635J, 629U, 629V Distributors		
B9600-311	12 Volt Negative Ground	\$154.95
B9600-311P6	6 Volt Positive Ground	\$165.45
International Harvester Truck 4 Cyl. 1968-1975 with Holley Distributor, & Curved Points		
B9600-239	12 Volt Negative Ground	\$119.25
International Harvester Truck 4 Cyl. 1972-1979 with Prestolite IDN-4009 Distributors		
B9600-044A	12 Volt Negative Ground	\$147.45
International Harvester Truck 6 Cyl. 1928-1941 C & D Models with Delco Distributor #622R		
B9600-309	12 Volt Negative Ground	\$154.95
B9600-309P6	6 Volt Positive Ground	\$169.45
International Harvester Truck 6 Cyl. 1946-1956 with Delco Distributor, 1957		
B9600-255LS	12 Volt Negative Ground	\$162.45
B9600-255LSP12	12 Volt Positive Ground	\$175.45
B9600-255LSP6	6 Volt Positive Ground	\$175.45
B9600-255LSN6	6 Volt Negative Ground	\$175.45

International Harvester Truck		
8 Cyl. 1959-1964 with Delco Distributor		
B9600-021	12 Volt Negative Ground	\$117.95
International Harvester Truck		
8 Cyl. 1964-1970 for Original Holley-built IHC Distributors & Clockwise Rotation		
B9600-048	12 Volt Negative Ground	\$134.45
International Harvester Truck		
8 Cyl. 1964-1970 with Holley Distributor & Counter Clockwise Rotation		
B9600-049	12 Volt Negative Ground	\$139.95
International Harvester Truck		
8 Cyl. 1977-1981 with Holley Gold Box Ignition		
B9600-204	12 Volt Negative Ground	\$154.95
International Harvester Truck		
8 Cyl. 1974-1983 with Prestolite #IDN-4002 Distributor & Factory Electronic Ignition		
B9600-050A	12 Volt Negative Ground	\$154.95
International Harvester Truck		
8 Cyl. 1974-1983 (All Except Prestolite #IDN-4007 Distributor)		
B9600-051A	12 Volt Negative Ground	\$154.95
International Harvester Truck		
8 Cyl. 1974-1983 with Prestolite #IDN-4007 Distributor & Factory Electronic Ignition		
B9600-052A	12 Volt Negative Ground	\$154.95





***For Ignition Coils & Accessories, see p.44**

CUTOUT RELAYS & VOLTAGE REGULATORS

Note: Due to modern battery design, voltage regulators can't be used to charge low or dead batteries. Doing so will destroy the voltage regulator and void the warranty.

B8001-001	6-Volt Cutout Relay	\$19.50
 <p>15 Amps, 6 Volt Works Positive or Negative Ground Replaces: Autolite - #CB4014, C4012(9-5), C4012(9-4), C4012(9-1), R40061 Delco - #266P, 266N, 265P, 265N, 5015850, 812970, 265J, 820845, 812971, 1116816, 265G, 265H, 1116755, 1116751, 1116809DR, 265B, 1842859, 265C, 1867781, 265F, 265D Fits: IHC Truck - 1928-1939</p>		

B8001-002	Electronic Cutout Relay	\$19.50
 <p>25 Amp, Works with 6, 12, or 24 Volts. & Positive or Negative Ground Replaces: Autolite - #CB4014, C4012(9-5), C4012(9-4), C4012(9-1), R40061 Delco - #266P, 266N, 265P, 265N, 5015850, 812970, 265J, 820845, 812971, 1116816, 265G, 265H, 1116755, 1116751, 1116809DR, 265B, 1842859, 265C, 1867781, 265F, 265D Fits: IHC Truck - 1928-1939</p>		

B8002-003	Delco 6-Volt Voltage Regulator	\$119.75
 <p>6 Volt, 3 Terminal, 26-30 Amps, Positive Ground, (Premium Quality, Made in the USA) Replaces: Delco - #1118208, 1118215, 1118230, 1118234, 1118253, 1118271, 1118303, 1118350, 1118871, 1119176, 5559, 5596, 5597, 5810, 5811, 5813, 5818, 5828, 5831, 5861, 5865, 5867, 5874, D5865, D603 Fits: IHC Truck - 1940-1956 (with Generator #1102673, 1102674, 1102713, 1102732, & 1105876)</p>		

6-Volt Delco Type Voltage Regulator		
B8002-001	Premium Quality, Made in the USA	\$87.75
B8002-042	Standard Quality	\$34.75
 <p>6 Volt, 3 Terminal, 32-42 Amps, Negative Ground, Flat Mounting Bracket, A-Circuit Replaces: Delco - 1118201, 1118300, 1118301, 1118357, 1118364, 1118721, 1118843, 1118847, 1118869, 1118872, D601, D614, D653 Fits: IHC Truck - 1946-1956</p>		

B8002-044	6-Volt Voltage Regulator	\$149.75
 <p>Positive Ground, 37-41 Amp, Made in the U.S.A. Replaces: Delco - #1118202, 1118212, 1118222, 1118226, 1118232, 1118238, 1118276, 1118278, 1118302, 1118314, 1118331, 1118351, 1118360, 1118366, 1118380, 1118382, 1118387, 1118392, 1118393, 1118726, 1118730, 1118731, 1118732, 1118743, 1118828, 1118829, 1118830, 1118834, 1118841, 1118842, 1118846, 1118850, 1118864, 1118865, 1118867, 1118950, 1119272, 5847, 5852, 5871, 5877, 5885, D602, D604, D607, D608, D610, D612. Fits: IHC Truck 1946-1956, 6 cyl</p>		

B8002-004	6-Volt Voltage Regulator	\$142.75
 <p>6 Volt, 3 Terminal, Negative Ground, Voltage Regulator Replaces: Delco #1118201, 1118207, 1118211, 1118216, 1118221, 1118233, 1118237, 1118242, 1118272, 1118301, 1118311, 1118313, 1118343, 1118349, 1118361, 1118720, 1118847, 1118866, 1118869, 1118872, 1118921, 5547, 5587, 5599, 5809, 5819, 5854, 5872, 5873, 5875, 5878, D601, D614, D653 Fits: IHC Truck - 1946-1956 (with Generator #1105677) PREMIUM QUALITY/ USA MADE</p>		

B8002-006	12-Volt Voltage Regulator	\$67.50
	12 Volt, 3 Terminal, Negative Ground, Voltage Regulator Fits: IHC Truck - 1946-1962 All (with Generator #1102005, 1102034, 1102044, 1102191, 1102955, 1105112, 1105115, 1105941, 1106822) 1963-1969 All with Generator PREMIUM QUALITY/ USA MADE	

ALTERNATOR VOLTAGE REGULATORS

B8002-030	12-Volt Alternator Voltage Regulator	\$14.50
	Heavy Duty, 12 Volt, Negative Ground Alternator Voltage Regulator. This external voltage regulator has 4 spade terminals (field, 2, 3, 4). It is designed for 'B' type circuits in negative ground systems. This is designed for use only in 12 volt systems. For Delco 10DN, & 20DN Replaces: Delco - #D630, D635, D663, 1119513, 1119515, 1119508, 1119519, D663, 1119502, 1119516, 1119506, 1119512, 1119515 Fits: International Harvester Truck - 1963-1969 w/ Alternators: #1100628, 1100629, 1100630, 1100633, 1963-1969 w/ Alternators: #1100687, 1100688, 1100690, 1100693, 1100694, 1100695, 1100696, 110061100750, 1100842, 1970-1972 w/ Alternators: #1100687, 1100693, 1100694, 1100695, 1100696, 1100842, 1970-1972 w/ Alternators: #1100629, 1100630, 1100633	

IDENTIFICATION TAGS

Delco Remy

B9013-003	Large Delco Remy I.D. Tag (Blank)	\$9.00
	Large Delco Remy I.D. Tag (Stamped)	\$16.25
	Large Black Delco-Remy I.D. Tag for Distributors, 6 Volt Starters, & 6 Volt Generators with Rivets, 1 1/4" X 2 7/8"	
B9013-004	Delco Remy I.D. Tag (Blank)	\$7.00
	Delco Remy I.D. Tag (Stamped)	\$14.25
	Black Delco-Remy I.D. Tag for Distributors, 6 Volt Starters, & 6 Volt Generators with Rivets, 3/4" 2 5/16"	
B9013-005	Red Delco Remy I.D. Tag (Blank)	\$7.00
	Red Delco Remy I.D. Tag (Stamped)	\$14.25
	Red Delco-Remy I.D. Tag for 12 Volt Starters & 12 Volt Generators with Rivets, 3/4" 2 5/16"	

B9013-013	Delco Remy I.D. Tag (Blank)	\$7.00
	Delco Remy I.D. Tag (Stamped)	\$14.25
	Black Delco-Remy I.D. Tag for Distributors, 6 Volt Starters, & 6 Volt Generators with Rivets, 3/4" 2 5/16"	



ALTERNATORS

B6001-001	12 Volt Alternator (1 Wire)	\$112.75
63 Amp, Low Cut In, Specially Built For Tractors, Forklifts, & Other Low Engine Speed Applications		
B6001-002	12 Volt Alternator (1 Wire/ 3 Wire)	\$118.75
63 Amp, With 1 Wire Or 3 Wire For Warning Lamp On Automobiles & Trucks		
B6001-005	6 Volt Alternator (1 Wire, Positive Ground)	\$166.50
6 Volt, 40 Amp Alternator with Positive Ground, 1 Wire, 3/8" pulley		

STARTER SWITCHES

B5006-004	Starter Switch	\$11.75
	6 or 12 Volt Starter Mounted Manual Push Button Starter Switch Fits: International Trucks - K1-K5, KB1-KB5, 1M-5M	

LIGHT SWITCHES

B5010-018	Turn Signal Light Switch	\$73.50
	Universal Turn Signal Switch. Has right turn, left turn, and warning flasher modes. Metal Construction with Color Coded Wire Leads. Fuse, clamp ring, and instruction sheet included. Fits: Pre-1953 Vehicles	

SOLENOIDS

B5007-042	6-Volt Delco Starter Solenoid Switch	\$52.75
	Replaces: Delco - #1114307, 1114310, 1114312, 1114410, 1118135, 1118140, 1118148, D936, D938, D939, D949, D964 Prestolite - #15-228, SWX-228, SWX-429 Fits: IHC Truck - 6 Cyl. 1954-1956	

JEWETT

SPARK PLUG WIRE SETS

1922 Jewett Automobile

6 Cyl. Tailored Spark Plug Wire Set

B1082-001	Original Type Cotton Braid Wire	\$50.75
B1082-001E	EPDM Wire	\$55.50

BATTERY CABLES







1922 Jewett Automobile



B2082-001	Positive Battery Cable	\$39.75
B2082-002	Negative Battery Cable	\$38.25
B2082-003	Switch to Starter Cable	\$46.75



TUNE UP PARTS

Jewett 6 Cylinder with Delco Distributor #637A

	B4001-021 Points Replaces: #1855520, D-109	\$13.75
	B4002-001 Condenser Replaces: #1928111, D-203, 1869704, D-200	\$4.75
	B4004-021 Rotor Replaces: #816774	\$14.75
	B4003-059 Cap Replaces: #816779, 822465, 1831800, 1853240	\$22.50

Jewett 1922 with Delco Distributor #647D

	B4001-013 Points Replaces: #1938330 (D-103P), 1882024 (D103), 1871678, 1871870, 1918148	\$16.25
	B4002-001 Condenser Replaces: #1928111, D-203, 1869704, D-200	\$4.75

	B4004-002 Rotor Replaces: #820445, D400	\$5.75
	B4003-002 Distributor Cap Premium Grade, Made in the USA (Brass Contacts) Replaces: #824735, D301	\$20.25
B4006-001	Dust Cover Replaces: #1900119	\$9.99



***For Ignition Coils & Accessories, see p.44**

ELECTRONIC IGNITION CONVERSION KITS

Replaces Points & Condenser



Jewett 6 Cyl. with Delco Distributor #637A

B9600-309	12 Volt Negative Ground	\$154.95
B9600-309P6	6 Volt Positive Ground	\$169.45

IDENTIFICATION TAGS

B9013-003	Large Delco Remy I.D. Tag (Blank)	\$9.00
	(Stamped)	\$16.25
	Large Black Delco-Remy I.D. Tag for Distributors, 6 Volt Starters, & 6 Volt Generators with Rivets, 1 1/4" X 2 7/8"	
B9013-013	Delco Remy I.D. Tag (Blank)	\$7.00
	Delco Remy I.D. Tag (Stamped)	\$14.25
	Black Delco-Remy I.D. Tag for Distributors, 6 Volt Starters, & 6 Volt Generators with Rivets, 3/4" X 2 5/16"	

SWITCHES

B5010-018	Turn Signal Light Switch	\$73.50
	Universal Turn Signal Switch. Has right turn, left turn, and warning flasher modes. Metal Construction with Color Coded Wire Leads. Fuse, clamp ring, and instruction sheet included. Fits: Pre-1953 Vehicles	

KAISER-FRAZER

SPARK PLUG WIRE SETS

Our Spark Plug Wire Sets Come Fully Assembled with the Proper Type Wire & Terminals.

They are Custom Tailored to Look & Fit Like Original Factory Equipment.

Varieties include:

PVC Wire: Copper Core with a Rubber Jacket.

EPDM Wire (E): Hi Performance Premium Conductor with a Tinned Copper Core, EPDM Insulation, Rubber Jacket.

Suppression Wire (S): for Electronic Ignition and is Spiral Wound, Low-Ohm, with EPDM Silicone Insulation and a Rubber Jacket.

Cotton Braid Suppression Wire (CS): also for Electronic Ignition, as Suppression Wire, but has an additional layer of Cotton Braid & Lacquer to replicate the vintage look, as well.



Kaiser 1947-1951

4 Cyl. Tailored Spark Plug Wire Set

B1083-001	Original Type PVC Wire	\$46.00
B1083-001E	EPDM Wire	\$55.50
B1083-001S	Suppression Wire	\$55.50

Kaiser 1951-1954 Henry J

4 Cyl. Tailored Spark Plug Wire Set

B1083-002	Original Type PVC Wire	\$31.75
B1083-002E	EPDM Wire	\$38.00

6 Cyl. Tailored Spark Plug Wire Set

B1083-003	Original Type PVC Wire	\$46.00
B1083-003E	EPDM Wire	\$55.50

BATTERY CABLES



Our Battery Cables are made from the Proper Gauge Copper, as either **Black Cotton Braided Wire** or **PVC Wire** (whichever is correct for the application), using Soldered & Heat Sealed Brass or Copper Terminals.

Kaiser 1947-1948

B2083-001	Positive Battery Cable	\$31.00
B2083-002	Negative Battery Cable	\$36.50

Kaiser 1949-1950

B2000-009	Positive Ground Strap	\$17.00
B2083-003	Negative Battery Cable	\$26.75
B2083-004	Switch to Starter Cable	\$32.25

Kaiser 1951-1952

Except Henry J

B2000-009	Positive Ground Strap	\$17.00
B2083-005	Negative Battery Cable	\$26.75
B2083-006	Switch to Starter Cable	\$25.75

Kaiser 1952-1954

Except Henry J

B2000-009	Positive Ground Strap	\$17.00
B2083-008	Negative Battery Cable	\$27.75

Kaiser 1953-1954

Henry J



B2000-009	Positive Ground Strap	\$17.00
B2083-007	Negative Battery Cable	\$34.50



TUNE UP PARTS

Kaiser-Frazer 1947-1951, 6 Cylinder with Autolite Distributor

	B4001-022	\$16.75
	Points Replaces: #IGS-2224, 1-44, 2084075	
	B4002-006	\$7.50
	Condenser Replaces: #2-31, 2-38, 2-42, 2-95, IAT-1125S, IAT-3076BS, IBB-2042SS-1, IBB-2042-SS3, IG-3927F, IG-3927G, IG-3927K, IG-3927R	
	B4004-007	\$8.25
	Rotor Premium Grade, Made in the USA Replaces: #4-19	
	B4003-007	\$25.00
	Distributor Cap Premium Grade, Made in the USA (Brass Contacts) Replaces: #IGC-1107S, 3-23	

Kaiser-Frazer 1951-1955, 6 Cylinder with Delco Distributor

	B4001-013	\$16.25
	Points Replaces: #1938330 (D-103P), 1882024 (D103), 1871678, 1871870, 1918148	
	B4002-001	\$4.75
	Condenser Replaces: #1928111, D-203, 1869704, D-200	

	B4004-002	\$5.75
	Rotor Replaces: #820445, D400	
	B4003-002	\$20.25
	Distributor Cap Premium Grade, Made in the USA (Brass Contacts) Replaces: #824735, D301	
B4006-001	Dust Cover	Replaces: #1900119 \$9.99

ELECTRONIC IGNITION CONVERSION KITS

Replaces Points & Condenser



Kaiser 6 Cyl. 1947-1951 All with Autolite IGS Series Distributor

B9600-307LS	12 Volt Negative Ground	\$169.45
B9600-307LSP6	6 Volt Positive Ground	\$185.95

Kaiser 6 Cyl. 1952 with Delco Remy Distributor #1110224

B9600-232	12 Volt Positive Ground	\$206.45
B9600-232P6	6 Volt Positive Ground	\$220.95

CUTOUT RELAYS & VOLTAGE REGULATORS

Note: Due to modern battery design, voltage regulators can't be used to charge low or dead batteries. Doing so will destroy the voltage regulator and void the warranty.

B8002-028	6-Volt Autolite Type Voltage Regulator	\$158.60
------------------	---	-----------------



6 Volt, 3 Terminal, Flat Mounting Bracket Regulator (Premium Quality/Made in the USA)

Replaces: **Prestolite** - #8-117, 8-70, 8-74, GRX-761, VBE-6102A, VBE-6104A, VBO-4601F, VBO-4601K, VBO-4602B, VBO-4602R, VRB-4002C, VRP-4001A,

VRP-4001B, VRP-4002D, VRP-4003A, VRP-4003B, VRP-4004A, VRP-4004C, VRP-4004F, VRP-4008A, VRP-6001A, VRP-6001B, VRP-6002A, VRP-6005A, VRP-6101A, VRP-6101B **Chrysler** - #1120515, 1121978, 1257394, 1321757, 1343573, 1571161, 2095209, 871763

Fits: **Kaiser** - 1947 to 1950 & 1951 With Autolite Generator

SWITCHES

B5010-018	Turn Signal Light Switch	\$73.50
	Universal Turn Signal Switch. Has right turn, left turn, and warning flasher modes. Metal Construction with Color Coded Wire Leads. Fuse, clamp ring, and instruction sheet included. Fits: Pre-1953 Vehicles	



ALTERNATORS

B6001-001	12 Volt Alternator (1 Wire)	\$112.75
63 Amp, Low Cut In, Specially Built For Tractors, Forklifts, & Other Low Engine Speed Applications		
B6001-005	6 Volt Alternator (1 Wire, Positive Ground)	\$166.50
6 Volt, 40 Amp Alternator with Positive Ground, 1 Wire, 3/8" pulley		

LAFAYETTE

BATTERY CABLES



Our Battery Cables are made from the Proper Gauge Copper, as either **Black Cotton Braided Wire** or **PVC Wire** (whichever is correct for the application), using Soldered & Heat Sealed Brass or Copper Terminals.

6 Cyl. LaFayette 1934-1935

B2084-001	Negative Battery Cable	\$32.25
------------------	------------------------	----------------

6 Cyl. LaFayette 1938

B2084-002	Negative Battery Cable	\$40.25
------------------	------------------------	----------------

6 Cyl. LaFayette 1939, Early

B2084-002	Negative Battery Cable	\$40.25
------------------	------------------------	----------------

6 Cyl. LaFayette 1939-1940, Late

B2000-004	Positive Ground Strap	\$10.50
------------------	-----------------------	----------------

LaFayette 1941

B2000-005	Positive Ground Strap	\$12.50
------------------	-----------------------	----------------

LASALLE BATTERY CABLES



Our Battery Cables are made from the Proper Gauge Copper, as either Black Cotton Braided Wire or PVC Wire (whichever is correct for the application), using Soldered & Heat Sealed Brass or Copper Terminals.

LaSalle 1932-1933

B2085-001	Negative Battery Cable	\$40.75
------------------	------------------------	----------------

LaSalle 1937

B2085-005	Negative Battery Cable	\$71.50
B2000-004	Positive Ground Strap	\$10.50

LaSalle 1938 V8

B2085-006	Negative Battery Cable	\$30.00
B2000-004	Positive Ground Strap	\$10.50

LaSalle 1939 V8

B2085-004	Negative Battery Cable	\$59.50
B2000-005	Positive Ground Strap	\$12.50

LaSalle 1940 V8 Series 50

B2085-007	Negative Battery Cable	\$53.25
B2000-005	Positive Ground Strap	\$12.50

LaSalle 1940 V8 Series 52

B2085-008	Negative Battery Cable	\$55.75
B2000-005	Positive Ground Strap	\$12.50

LaSalle 1941

B2085-002	Negative Battery Cable	\$28.00
------------------	------------------------	----------------

CUTOUT RELAYS & VOLTAGE REGULATORS

Note: Due to modern battery design, voltage regulators can't be used to charge low or dead batteries. Doing so will destroy the voltage regulator and void the warranty.

B8001-001 6-Volt Cutout Relay **\$19.50**



15 Amps, 6 Volt Works Positive or Negative Ground

Replaces:

Autolite - #CB4014, C4012(9-5), C4012(9-4), C4012(9-1), R40061

Delco - #266P, 266N, 265P, 265N, 5015850, 812970, 265J, 820845, 812971,

1116816, 265G, 265H, 1116755, 1116751, 1116809DR, 265B, 1842859, 265C, 1867781, 265F, 265D

Fits: **LaSalle** - 8 Cyl. 1930-1931

B8001-002 Electronic Cutout Relay **\$19.50**



25 Amp, Works with 6, 12, or 24 Volts. & Positive or Negative Ground

Replaces:

Autolite - #CB4014, C4012(9-5), C4012(9-4), C4012(9-1), R40061

Delco - #266P, 266N, 265P, 265N, 5015850, 812970, 265J, 820845, 812971,

1116816, 265G, 265H, 1116755, 1116751, 1116809DR, 265B, 1842859, 265C, 1867781, 265F, 265D

Fits: **LaSalle** - 8 Cyl. 1930-1931

6-Volt Saddle Mounted Cutout Relay (Delco Version)

B8001-004 Premium Quality, Made in the USA **\$122.50**

B8001-006 Standard Quality **\$38.59**



Cutout Relay, 25 Amp, 6 Volt, Works Positive or Negative Ground.

Replaces:

Delco - #266P, 266N, 265P, 265N, 5015850, 812970, 265J, 820845, 812971,

1116816, 265G, 265H, 1116755, 1116751, 1116809DR, 265B, 1842859,

265C, 1867781, 265F, 265D

Fits: **LaSalle** - 8 Cyl. 1930-1931

LINCOLN

SPARK PLUG WIRE SETS

Our Spark Plug Wire Sets Come Fully Assembled with the Proper Type Wire & Terminals.

They are Custom Tailored to Look & Fit Like Original Factory Equipment.

Varieties include:

Cotton Braid Wire: Copper Core with a Cotton Braid Jacket.

PVC Wire: Copper Core with a Rubber Jacket.

EPDM Wire (E): Hi Performance Premium Conductor with a Tinned Copper Core, EPDM Insulation, Rubber Jacket.

Suppression Wire (S): for Electronic Ignition and is Spiral Wound, Low-Ohm, with EPDM Silicone Insulation and a Rubber Jacket.



Lincoln 1947 Zephyr

12 Cyl. Tailored Spark Plug Wire Set

B1086-004	Original Type Cotton Braid Wire	\$76.25
B1086-004E	EPDM Wire	\$83.25

Lincoln 1949-1951

8 Cyl. Tailored Spark Plug Wire Set

B1086-001	Original Type Cotton Braid Wire	\$68.00
B1086-001E	EPDM Wire	\$74.00

Lincoln 1952-1955

8 Cyl. Tailored Spark Plug Wire Set

B1086-002	Original Type PVC Wire	\$61.75
B1086-002E	EPDM Wire	\$74.00

Lincoln 1975-1976

w/ 460" Engine

8 Cyl. Tailored Spark Plug Wire Set

B1086-003	Original Type EPDM Wire	\$60.25
B1086-003S	Suppression Wire	\$72.50

BATTERY CABLES



Lincoln 1932-1938 V12

B2086-001	Negative Battery Cable	\$45.25
------------------	-------------------------------	----------------

Lincoln 1939 Zephyr

B2086-002	Positive Battery Cable	\$37.00
B2086-003	Negative Battery Cable	\$31.00
B2086-004	Switch to Starter Cable	\$32.00

Lincoln 1940-1942 V12

B2000-006	Positive Ground Strap	\$13.50
B2086-005	Negative Battery Cable	\$41.25

Lincoln 1946-1948 V12

B2000-008	Positive Ground Strap	\$15.50
B2086-006	Negative Battery Cable	\$31.25

Lincoln 1949 V8

B2000-007	Positive Ground Strap	\$14.50
B2086-007	Negative Battery Cable	\$33.25
B2086-008	Switch to Starter Cable	\$38.00

Lincoln 1950-1951

(Except Cosmopolitan)

B2000-007	Positive Ground Strap	\$14.50
B2086-009	Negative Battery Cable	\$42.00
B2086-010	Switch to Starter Cable	\$32.00

Lincoln 1950-1951

(Cosmopolitan)

B2000-007	Positive Ground Strap	\$14.50
B2086-011	Negative Battery Cable	\$42.00
B2086-012	Switch to Starter Cable	\$38.50

Lincoln 1952-1955 V8

B2000-008	Positive Ground Strap	\$15.50
B2086-013	Negative Battery Cable	\$42.00
B2086-014	Switch to Starter Cable	\$29.25

SWITCHES

B5010-018	Turn Signal Light Switch	\$73.50
		Universal Turn Signal Switch. Has right turn, left turn, and warning flasher modes. Metal Construction with Color Coded Wire Leads. Fuse, clamp ring, and instruction sheet included. Fits: Pre-1953 Vehicles

MACK TRUCK

TABLE OF CONTENTS

Spark Plug Wire Sets _____	510
Tune Up Parts _____	511
Electronic Ignition Conversion Kit _____	514
Identification Tags _____	514
Voltage Regulators _____	514
Alternators _____	514
Switches _____	514

SPARK PLUG WIRE SETS

Our Spark Plug Wire Sets Come Fully Assembled with the Proper Type Wire & Terminals.

They are Custom Tailored to Look & Fit Like Original Factory Equipment.

Varieties include:

Cotton Braid Wire: Copper Core with a Cotton Braid Jacket.

EPDM Wire (E): Hi Performance Premium Conductor with a Tinned Copper Core, EPDM Insulation, Rubber Jacket.

Suppression Wire (S): for Electronic Ignition and is Spiral Wound, Low-Ohm, with EPDM Silicone Insulation and a Rubber Jacket.

Cotton Braid Suppression Wire (CS): also for Electronic Ignition, as Suppression Wire, but has an additional layer of Cotton Braid & Lacquer to replicate the vintage look, as well.



Mack Truck AC 1921

4 Cyl. Tailored Spark Plug Wire Set

B1087-010	Original Type Cotton Braid Wire	\$52.25
B1087-010E	EPDM Wire	\$57.00

Mack Fire Truck Model BM

4 X 5 1/2 (414 CI) Engine, Dual Ignition

6 Cyl. Tailored Spark Plug Wire Set

B1087-001	Original Type Cotton Braid Wire	\$192.25
B1087-001E	EPDM Wire	\$209.75

Mack Truck Model EN11, 1936-1944

ED Pickup

With Continental F209 Engine, Single Ignition

6 Cyl. Tailored Spark Plug Wire Set

B1087-002	Original Type Cotton Braid Wire	\$50.75
B1087-002E	EPDM Wire	\$55.50

EG Pickup

With Continental FKD 290 Engine, Single Ignition

6 Cyl. Tailored Spark Plug Wire Set

B1087-009	Original Type Cotton Braid Wire	\$50.75
B1087-009E	EPDM Wire	\$55.50

Mack Truck 1941-1946 Model EN330

With Continental Engine, Single Ignition

6 Cyl. Tailored Spark Plug Wire Set

B1087-003	Original Type Cotton Braid Wire	\$50.75
B1087-003E	EPDM Wire	\$55.50
B1087-003S	Suppression Wire	\$55.50
B1087-003CS	Cotton Suppression Wire	\$87.50

Mack Truck Model EN290, EN330

With Continental Engine, Dual Ignition

6 Cyl. Tailored Spark Plug Wire Set

B1087-014	Original Type Cotton Braid Wire	\$139.00
------------------	--	-----------------

Mack Truck 1941-1967 Model EN291, EN331, EN377

Single Ignition, Replaces Mack #19MRA261

6 Cyl. Tailored Spark Plug Wire Set

B1087-004	Original Type EPDM Wire	\$55.50
B1087-004S	Suppression Wire	\$55.50

Mack Truck 1941-1967 Model ENF291, ENF331, ENF377

Dual Ignition, Replaces Mack #19MRA261, & 19MRA263

6 Cyl. Tailored Spark Plug Wire Set

B1087-012	Original Type EPDM Wire	\$126.00
------------------	--------------------------------	-----------------

Mack Fire Truck Model ENF464 Engine

Dual Ignition

6 Cyl. Tailored Spark Plug Wire Set

B1087-005	Original Type EPDM Wire	\$103.25
------------------	--------------------------------	-----------------

Mack Fire Truck Model ENF510 Engine

Dual Ignition

6 Cyl. Tailored Spark Plug Wire Set

B1087-006	Original Type EPDM Wire	\$103.25
------------------	--------------------------------	-----------------

Mack Truck, Model 707A, 707B Engine

Single Ignition

6 Cyl. Tailored Spark Plug Wire Set

B1087-011	Original Type EPDM Wire	\$64.00
B1087-011S	Suppression Wire	\$64.00

Mack Fire Truck, Model ENF707A, ENF707B Engine

Dual Ignition

6 Cyl. Tailored Spark Plug Wire Set

B1087-007	Original Type EPDM Wire	\$163.25
B1087-007S	Suppression Wire	\$163.25

Mack Fire Truck, Model ENF707C Engine

Dual Ignition



6 Cyl. Tailored Spark Plug Wire Set

B1087-008	Original Type EPDM Wire	\$148.25
------------------	--------------------------------	-----------------

TUNE UP PARTS

Mack 6 Cylinder 1931-1946 with Delco Distributor #4191		
	B4001-013	\$16.25
Points Replaces: #1938330 (D-103P), 1882024 (D103), 1871678, 1871870, 1918148		
	B4002-001	\$4.75
Condenser Replaces: #1928111, D-203, 1869704, D-200		
	B4003-002	\$20.25
Distributor Cap Premium Grade, Made in the USA (Brass Contacts) Replaces: #824735, D301		
	B4004-002	\$5.75
Rotor Replaces: #820445, D400		
B4006-001	Dust Cover	Replaces: #1900119 \$9.99

Mack 6 Cylinder 1935 Model BM 4 X 5 1/2 Mack Engine		
	B4001-001	\$4.75
Points Replaces: #D100HP, 1855720		
	B4002-001	\$4.75
Condenser Replaces #1928111, D-203, 1869704, D-200		
	B4004-036	\$10.50
Rotor Premium Grade, Made in the USA Replaces: #1849504		
	B4003-002	\$20.25
Distributor Cap Premium Grade, Made in the USA (Brass Contacts) Replaces: #824735, D301		
	B4007-001	\$11.95
Cap Clip Short Mount, 1 Used Replaces: #1889967, 1847289, 453844, 453461		
	B4007-002	\$11.95
Cap Clip Long Mount, 1 Used Replaces: #1889967, 1889999, 453844, 453461		
B4006-001	Dust Cover	Replaces: #1900119 \$9.99

	B4008-001	\$14.99
Distributor Insulator Replaces: #1904376		
	B4009-001	\$25.99
Distributor Bushing & Shim Kit		

*For 6- or 12-Volt Ignition Coils & Accessories, see p.44

Mack 6 Cylinder 1936-1941 ED Mack Engine with Delco Distributor #623H		
	B4001-021	\$13.75
Points Replaces: #1855520, D-109		
	B4002-001	\$4.75
Condenser Replaces: #1928111, D-203, 1869704, D-200		
	B4004-021	\$14.75
Rotor Replaces: #816774		
	B4003-059	\$22.50
Cap Replaces: #816779, 822465, 1831800, 1853240		

*For 6- or 12-Volt Ignition Coils & Accessories, see p.44



Mack 6 Cylinder 1936-1947 (CE Engine with Delco Distributor #649X)		
	B4001-001	\$4.75
Points Replaces: #D100HP, 1855720		
	B4002-001	\$4.75
Condenser Replaces: #1928111, D-203, 1869704, D-200		
	B4004-036	\$10.50
Rotor Premium Grade, Made in the USA Replaces: #1849504		
	B4003-002	\$20.25
Distributor Cap Premium Grade, Made in the USA (Brass Contacts) Replaces: #824735, D301		
B4006-001	Dust Cover	Replaces: #1900119 \$9.99

	B4007-001	\$11.95
	Cap Clip Short Mount, 1 Used Replaces: #1889967, 1847289, 453844, 453461	
	B4007-002	\$11.95
	Cap Clip Long Mount, 1 Used Replaces: #1889967, 1889999, 453844, 453461	
	B4008-001	\$14.99
	Distributor Insulator Replaces: #1904376	
	B4009-001	\$25.99
	Distributor Bushing & Shim Kit	

*For 6- or 12-Volt Ignition Coils & Accessories, see p.44

Mack 6 Cylinder 1941-1946 (EN330 Engine), 1951-1966 (331, 401, 540, 438, EMF464, EMF510) with Distributor #1111753, 1111848 & Others

	B4100-001	\$10.50
	PCR Kit Includes: Points (#B4001-001), Condenser (#B4002-001), Rotor (#B4004-002) Replaces: Points - #D100HP, 1855720 Condenser - #1928111, D-203, 1869704, D-200 Rotor - #820445, D400	
	B4004-002	\$5.75
	Rotor Replaces: #820445, D400	
	B4003-002	\$20.25
	Distributor Cap Premium Grade, Made in the USA (Brass Contacts) Replaces: #824735, D301	
	B4006-001	\$9.99
	Dust Cover Replaces: #1900119	
	B4007-001	\$11.95
	Cap Clip Short Mount, 1 Used Replaces: #1889967, 1847289, 453844, 453461	
	B4007-002	\$11.95
	Cap Clip Long Mount, 1 Used Replaces: #1889967, 1889999, 453844, 453461	

	B4008-001	\$14.99
	Distributor Insulator Replaces: #1904376	
	B4009-001	\$25.99
	Distributor Bushing & Shim Kit	

*For 6- or 12-Volt Ignition Coils & Accessories, see p.44





Mack 6 Cylinder 1941-1947, 707 GAS with Delco Distributor #1110143

	B4001-001	\$4.75
	Points Replaces: #D100HP, 1855720	
	B4002-001	\$4.75
	Condenser Replaces: #1928111, D-203, 1869704, D-200	
	B4004-036	\$10.50
	Rotor Premium Grade, Made in the USA Replaces: #1849504	
	B4003-002	\$20.25
	Distributor Cap Premium Grade, Made in the USA (Brass Contacts) Replaces: #824735, D301	
	B4007-001	\$11.95
	Cap Clip Short Mount, 1 Used Replaces: #1889967, 1847289, 453844, 453461	
	B4007-002	\$11.95
	Cap Clip Long Mount, 1 Used Replaces: #1889967, 1889999, 453844, 453461	
	B4008-001	\$14.99
	Distributor Insulator Replaces: #1904376	
	B4009-001	\$25.99
	Distributor Bushing & Shim Kit	
B4006-001	Dust Cover	Replaces: #1900119 \$9.99

*For 6- or 12-Volt Ignition Coils & Accessories, see p.44



Mack 6 Cylinder 1948-1958 L85 with 707B Gas Engine & Distributor #1111757, 1111780		
	B4100-002	\$10.50
	PCR Kit Includes: Points (#B4001-001), Condenser (#B4002-003), Rotor (#B4004-002) Replaces: Points - #D100HP, 1855720 Condenser - #1928111, D203 Rotor - #820445, D400	
	B4003-002	\$20.25
	Distributor Cap Premium Grade, Made in the USA (Brass Contacts) Replaces: #824735, D301	
	B4004-002	\$5.75
	Rotor Replaces: #820445, D400	
	B4006-001	\$9.99
	Dust Cover Replaces: #1900119	
	B4007-001	\$11.95
	Cap Clip Short Mount, 1 Used Replaces: #1889967, 1847289, 453844, 453461	
	B4007-002	\$11.95
	Cap Clip Long Mount, 1 Used Replaces: #1889967, 1889999, 453844, 453461	
	B4009-001	\$25.99
	Distributor Bushing & Shim Kit	

*For 12-Volt Ignition Coils & Accessories, see p.44



Mack 6 Cylinder 1958 B61 with EN402 Engine		
	B4001-001	\$4.75
	Points Replaces: #D100HP, 1855720	
	B4002-012	\$4.75
	Condenser Replaces: #D205	
	B4003-002	\$20.25
	Distributor Cap Premium Grade, Made in the USA (Brass Contacts) Replaces: #824735, D301	
	B4004-002	\$5.75
	Rotor Replaces: #820445, D400	

	B4007-001	\$11.95
	Cap Clip Short Mount, 1 Used Replaces: #1889967, 1847289, 453844, 453461	
	B4007-002	\$11.95
	Cap Clip Long Mount, 1 Used Replaces: #1889967, 1889999, 453844, 453461	
	B4009-001	\$25.99
	Distributor Bushing & Shim Kit	
B4006-001	Dust Cover	Replaces: #1900119 \$9.99

*For 6- or 12-Volt Ignition Coils & Accessories, see p.44

Mack 6 Cylinder 1958, EMF707B Gas with Delco Distributor		
	B4001-001	\$4.75
	Points Replaces: #D100HP, 1855720	
	B4002-003	\$4.75
	Condenser Replaces: #1928111, D203	
	B4003-034	\$18.25
	Cap Replaces: #268574C92	
	B4004-022	\$6.50
	Rotor Replaces: #1924245, D-405	

*For 6- or 12-Volt Ignition Coils & Accessories, see p.44

Mack 6 Cylinder 1962 B42 Gas with Delco Distributor #1111849		
	B4100-002	\$10.50
	PCR Kit Includes: Points (#B4001-001), Condenser (#B4002-003), Rotor (#B4004-002) Replaces: Points - #D100HP, 1855720 Condenser - #1928111, D203 Rotor - #820445, D400	
	B4003-002	\$20.25
	Distributor Cap Premium Grade, Made in the USA (Brass Contacts) Replaces: #824735, D301	
	B4004-002	\$5.75
	Rotor Replaces: #820445, D400	

	B4006-001	\$9.99
	Dust Cover Replaces: #1900119	
	B4007-001	\$11.95
	Cap Clip Short Mount, 1 Used Replaces: #1889967, 1847289, 453844, 453461	
	B4007-002	\$11.95
	Cap Clip Long Mount, 1 Used Replaces: #1889967, 1889999, 453844, 453461	
	B4009-001	\$25.99
	Distributor Bushing & Shim Kit	

*For 12-Volt Ignition Coils & Accessories, see p.44

ELECTRONIC IGNITION CONVERSION KITS

Replaces Points & Condenser



Mack 6 Cylinder 1936-1941 ED Mack Engine with Delco Distributor #623H

B9600-309	12 Volt Negative Ground	\$154.95
B9600-309N6	6 Volt Negative Ground	\$169.45

Mack 6 Cyl. 1935 Model BM 4 X 5 1/2 (Mack Engine), 1936-1947 (CE Engine with Delco Distributor #649X), 1941-1946 (EN330 Engine), 1951-1966 (331, 401, 540, 438, EMF464, EMF510) with Distributor #1111848 & Others), 1941-1947 707 GAS (with Delco Distributor #1110143), 1948-1958 Model 85, L85, 95, L95 (with 707B Gas Engine with Distributor #1111757, 1111780), 1958 B61 (with EN402 Engine), 1962 B42 Gas (with Delco Distributor #1111849)

B9600-255LS	12 Volt Negative Ground	\$162.45
B9600-255LSP12	12 Volt Positive Ground	\$175.45
B9600-255LSP6	6 Volt Positive Ground	\$175.45



*For Ignition Coils & Accessories, see p.44

IDENTIFICATION TAGS

B9013-003	Large Delco Remy I.D. Tag (Blank)	\$9.00
	(Stamped)	\$16.25
Large Black Delco-Remy I.D. Tag for Distributors, 6 Volt Starters, & 6 Volt Generators with Rivets, 1 1/4" X 2 7/8"		
B9013-004	Delco Remy I.D. Tag (Blank)	\$7.00
	(Stamped)	\$14.25
Black Delco-Remy I.D. Tag for Distributors, 6 Volt Starters, & 6 Volt Generators with Rivets, 3/4" 2 5/16"		
B9013-005	Red Delco Remy I.D. Tag (Blank)	\$7.00
	(Stamped)	\$14.25
Red Delco-Remy I.D. Tag for 12 Volt Starters & 12 Volt Generators with Rivets, 3/4" 2 5/16"		
B9013-013	Delco Remy I.D. Tag (Blank)	\$7.00
	(Stamped)	\$14.25
Black Delco-Remy I.D. Tag for Distributors, 6 Volt Starters, & 6 Volt Generators with Rivets, 3/4" 2 5/16"		

VOLTAGE REGULATORS

Note: Due to modern battery design, voltage regulators can't be used to charge low or dead batteries. Doing so will destroy the voltage regulator and void the warranty.

B8002-041	12-Volt Delco Voltage Regulator	\$78.75
	12 Volt, 4 Terminal, Flat Mounting (Premium Quality, Made in the USA)	
	Mack Truck Replaces: Delco - #1118279, 1118339, 1118368, 1118838, 1118880, 1118881, 1118883, 1118939, 1119156, 1119200, 1119269, 1119607, D651	
Fits: 1957, 1959		



ALTERNATORS

B6001-001	12 Volt Alternator (1 Wire)	\$112.75
63 Amp, Low Cut In, Specially Built For Tractors, Forklifts, & Other Low Engine Speed Applications		
B6001-005	6 Volt Alternator (1 Wire, Positive Ground)	\$166.50
6 Volt, 40 Amp Alternator with Positive Ground, 1 Wire, 3/8" pulley		

SWITCHES

B5010-018	Turn Signal Light Switch	\$73.50
	Universal Turn Signal Switch. Right turn, left turn, and warning flasher. Metal Construction with Color Coded Wire Leads. Fuse, clamp ring, and instruction sheet included.	
	Fits: Mack, Marmon - Pre-1953	

MARMON MOTOR CAR COMPANY





Marmon 1928 Model 68

8 Cyl. Tailored Spark Plug Wire Set

B1113-001	Original Type Cotton Braid Wire	\$76.00
B1113-001E	EPDM Wire	\$83.00

MARQUETTE AUTOMOBILES

Marquette 1930 with Delco Distributor #639Y

	B4001-021 Points Replaces: #1855520, D-109	\$13.75
	B4002-001 Condenser Replaces: #1928111, D-203, 1869704, D-200	\$4.75
	B4004-021 Rotor Replaces: #816774	\$14.75
	B4003-059 Cap Replaces: #816779, 822465, 1831800, 1853240	\$22.50

MERCURY

TABLE OF CONTENTS

Spark Plug Wire Sets _____	515
Battery Cables _____	516
Tune Up Parts _____	516
Electronic Ignition Conversion Kits _____	518
Voltage Regulators _____	519
Light Switches _____	519
Alternators _____	519

SPARK PLUG WIRE SETS

Our Spark Plug Wire Sets Come Fully Assembled with the Proper Type Wire & Terminals.

They are Custom Tailored to Look & Fit Like Original Factory Equipment.

Varieties include:

Cotton Braid Wire: Copper Core with a Cotton Jacket.

PVC Wire: Copper Core with a Rubber Jacket.

EPDM Wire (E): Hi Performance Premium Conductor with a Tinned Copper Core, EPDM Insulation, Rubber Jacket.

Cotton Braid Suppression Wire (CS): also for Electronic Ignition, as Suppression Wire, but has an additional layer of Cotton Braid & Lacquer to replicate the vintage look, as well.



Mercury 1940-1948

8 Cyl. Tailored Spark Plug Wire Set

B1088-001	Original Type Cotton Braid Wire	\$68.00
B1088-001E	EPDM Wire	\$74.00

Mercury 1949-1953

8 Cyl. Tailored Spark Plug Wire Set

B1088-002	Original Type Cotton Braid Wire	\$68.00
B1088-002E	EPDM Wire	\$74.00
B1088-002CS	Cotton Suppression Wire	\$117.25

Mercury 1954-1955

8 Cyl. Tailored Spark Plug Wire Set

B1088-003	Original Type PVC Wire	\$61.75
B1088-003E	EPDM Wire	\$74.00

Mercury 1975-1976

w/ 351"-M, 400", 460" Engines

8 Cyl. Tailored Spark Plug Wire Set

B1088-004	Original Type EPDM Wire	\$74.00
B1088-004S	Suppression Wire	\$74.00

BATTERY CABLES



Our Battery Cables are made from the Proper Gauge Copper, as either **Black Cotton Braided Wire** or **PVC Wire** (whichever is correct for the application), using Soldered & Heat Sealed Brass or Copper Terminals.

Mercury 1939

B2000-005	Positive Ground Strap	\$12.50
B2088-001	Negative Battery Cable	\$31.00

Mercury 1940-1948

B2000-002	Positive Ground Strap	\$9.50
B2088-002	Negative Battery Cable	\$36.50
B2088-003	Switch to Starter Cable	\$32.00

Mercury 1949-1951

B2000-007	Positive Ground Strap	\$14.50
B2088-004	Negative Battery Cable	\$31.00
B2088-005	Switch to Starter Cable	\$60.25

Mercury 1952-1953

B2088-006	Positive Battery Cable	\$37.00
B2088-007	Negative Battery Cable	\$34.00
B2088-008	Switch to Starter Cable	\$32.00

Mercury 1954

B2088-009	Positive Battery Cable	\$42.00
B2088-010	Negative Battery Cable	\$34.00
B2088-011	Switch to Starter Cable	\$41.75

Mercury 1955

B2088-012	Positive Battery Cable	\$42.00
B2088-013	Negative Battery Cable	\$34.00
B2088-014	Switch to Starter Cable	\$41.75

TUNE UP PARTS

Mercury 6 Cylinder 1960-1967 All 1966-1967 without T.E.C.

	B4100-005	\$9.75
	PCR Kit Includes: Points (#B4001-010), Condenser (#B4002-009), Rotor (#B4004-009) Replaces: Points - #FAA-12171A (DP-3), 7RA-12171 (DP-7) Condenser - #7RA-12300, DC-6 Rotor - #1972022, DR-1	



	B4003-047	\$16.25
	Cap Replaces: #7HA-12106	
	B4004-009	\$4.75
	Rotor Premium Grade, Made in the USA Replaces: #1972022, DR-1	
	B4007-005	\$4.25
	Rotor Clip Replaces: #8N-12213	



Mercury 6 Cylinder 1966-1967 All 1966-1967 with T.E.C. (Except V6 Capri)

	B4001-010	\$4.75
	Points Replaces: #FAA-12171A (DP-3), 7RA-12171 (DP-7)	
	B4002-018	\$10.50
	Condenser Replaces: #B9AF-12300, DC-13A	
	B4003-047	\$16.25
	Cap Replaces: #7HA-12106	
	B4004-031	\$7.00
	Rotor Replaces: #3230821, F-405	

Mercury 6 Cylinder 1975-1976

	B4003-073	\$30.00
	Cap Replaces: #D5DZ-12106A, D7TZ-12106B (DH-353)	
	B4004-031	\$7.00
	Rotor Replaces: #3230821, F-405	

Mercury 6 Cylinder 1977-1985		
	B4003-061	\$13.50
	Cap Made in the USA Replaces: #C193	
	B4004-039	\$4.75
	Rotor Made in the USA Replaces: #D219	

Mercury 8 Cylinder 1939-1942 (All)		
	B4001-027	\$25.75
	Points Set of 2 Replaces: #9N-12107, DP-2, DP-61	
	B4002-020	\$14.75
	Condenser Replaces: #78-12300, DC-7	

Mercury 8 Cylinder 1946-1948 (All)		
	B4001-027	\$25.75
	Points Set of 2 Replaces: #9N-12107, DP-2, DP-61	
	B4002-020	\$14.75
	Condenser Replaces: #78-12300, DC-7	
	B4004-009	\$4.75
	Rotor Premium Grade, Made in the USA Replaces: #1972022, DR-1	
	B4007-005	\$4.25
	Rotor Clip Replaces: #8N-12213	



Mercury 8 Cylinder 1949-1953		
	B4100-005	\$9.75
	PCR Kit Includes: Points (#B4001-010), Condenser (#B4002-009), Rotor (#B4004-009) Replaces: Points - #FAA-12171A (DP-3), 7RA-12171 (DP-7) Condenser - #7RA-12300, DC-6 Rotor - #1972022, DR-1	

	B4003-049	\$18.75
	Cap Replaces: #FAB-12106A, DH-1	
	B4004-009	\$4.75
	Rotor Premium Grade, Made in the USA Replaces: #1972022, DR-1	
	B4007-005	\$4.25
	Rotor Clip Replaces: #8N-12213	

*For 6-Volt Ignition Coils & Accessories, see p.44

Mercury 8 Cylinder 1954-1955		
	B4001-028	\$7.00
	Points Replaces: #FAB-12171A, FAB-12171B (DP-4, DP-5), (Holley) 76D-94AS, (IHC) 149356-R92	
	B4002-009	\$4.75
	Condenser Replaces: #7RA-12300, FAB-12300A, DC-2, DC-6	
	B4003-049	\$18.75
	Cap Replaces: #FAB-12106A, DH-1	
	B4004-009	\$4.75
	Rotor Premium Grade, Made in the USA Replaces: #1972022, DR-1	
	B4007-005	\$4.25
	Rotor Clip Replaces: #8N-12213	

*For 6-Volt Ignition Coils & Accessories, see p.44

Mercury 8 Cylinder 1956		
	B4001-028	\$7.00
	Points Replaces: #FAB-12171A, FAB-12171B (DP-4, DP-5), (Holley) 76D-94AS, (IHC) 149356-R92	
	B4002-009	\$4.75
	Condenser Replaces: #7RA-12300, FAB-12300A, DC-2, DC-6	

	B4003-049 Cap Replaces: #FAB-12106A, DH-1	\$18.75
	B4004-009 Rotor Premium Grade, Made in the USA Replaces: #1972022, DR-1	\$4.75
	B4007-005 Rotor Clip Replaces: #8N-12213	\$4.25

*For 6-Volt Ignition Coils & Accessories, see p.44

Mercury 8 Cylinder 1957-1959

	B4001-011 Points Replaces: #B7A-12171A, B8Q-12171A, DP-9	\$4.75
	B4002-022 Condenser	\$6.50
	B4003-050 Cap Replaces: #B7A12106A, DH-6	\$14.00
	B4004-033 Rotor Replaces: #3230765, F-400	\$5.50

Mercury 8 Cylinder 1960-1974 (All With Single Points)

	B4001-011 Points Replaces: #B7A-12171A, B8Q-12171A, DP-9	\$4.75
	B4002-018 Condenser Replaces: #B9AF-12300, DC-13A	\$10.50
	B4003-050 Cap Replaces: #B7A12106A, DH-6	\$14.00

	B4004-033 Rotor Replaces: #3230765, F-400	\$5.50
--	---	---------------

Mercury 1960-1972 All with Dual Points

	B4001-028 Points Replaces: #FDS-12171A, DP-6, C8AZ-12171A	\$12.75
	B4002-009 Condenser Replaces: #7RA-12300, FAB-12300A, DC-2, DC-6	\$4.75
	B4003-050 Cap Replaces: #B7A12106A, DH-6	\$14.00
	B4004-033 Rotor Replaces: #3230765, F-400	\$5.50

Mercury 8 Cylinder 1977-1993

	B4003-063 Cap Made in the USA Replaces: #D7AZ-12106A, DH-366	\$24.25
--	---	----------------

ELECTRONIC IGNITION CONVERSION KITS

Replaces Points & Condenser



Mercury 4 Cyl. 1971-1972 All with 98 cid. Engine (1600cc)

B9600-306LS	12 Volt Negative Ground	\$185.95
--------------------	-------------------------	-----------------

Mercury 6 Cyl. 1960-1965 all, 1966-1967 without T.E.C. (Smog Pump)

B9600-036	12 Volt Negative Ground	\$124.95
------------------	-------------------------	-----------------

Mercury 6 Cyl. 1966-1967 with T.E.C. (Smog Pump), 1968-1974 All

B9600-032	12 Volt Negative Ground	\$124.95
------------------	-------------------------	-----------------

Mercury 8 Cyl. 1957-1974 Single Point Distributor		
B9600-037	12 Volt Negative Ground	\$117.95
Mercury 8 Cyl. 1960-1972 Dual Point Distributor Mechanical Advance Distributor		
B9600-037D	12 Volt Negative Ground	\$101.23
Mercury 8 Cyl. 1960-1972 Dual Point Distributor Vacuum Advance Distributor		
B9600-037DV	12 Volt Negative Ground	\$124.95



ALTERNATORS

B6001-001	12 Volt Alternator (1 Wire)	\$112.75
63 Amp, Low Cut In, Specially Built For Tractors, Forklifts, & Other Low Engine Speed Applications		
B6001-002	12 Volt Alternator (1 Wire/ 3 Wire)	\$118.75
63 Amp, With 1 Wire Or 3 Wire For Warning Lamp On Automobiles & Trucks		
B6001-005	6 Volt Alternator (1 Wire, Positive Ground)	\$166.50
6 Volt, 40 Amp Alternator with Positive Ground, 1 Wire, 3/8" pulley		



***For Ignition Coils & Accessories, see p.44**

VOLTAGE REGULATORS

Note: Due to modern battery design, voltage regulators can't be used to charge low or dead batteries. Doing so will destroy the voltage regulator and void the warranty.

B8002-033	Ford 12-Volt Alternator Voltage Regulator	14.75
 <p>Mercury Fits Alternators: 1964-1978 Replaces: #C3SZ-10316-A, C3SZ-10316-B, C3TF-10316-B, C3XF-10316-C, C4SF-10316-A, C4SZ-10316-A, C4TF-10316-B, C4TF-10316-D, C4UF-10316-A, C4UF-10316-B, C5AF-10316-A, C5AZ-10316-A, C5TF-10316-A, C8AF-10316-A, C8TF-10316-A, D0AF-10316-A, D3TZ-10316-A, GR341, GR341A, GR503, GR533, GR534 (PREMIUM QUALITY/ USA MADE)</p>		

B8002-035	Ford 12-Volt Voltage Regulator	\$109.75
 <p>Mercury Fits: 1957-1960 Replaces: #B8A-10105A/B, B8E-10505B/C, B9C-10505A, C1TF-10505C, C2AF-10505B, C2AZ-10505B/C, C2SZ-10505A, C2TF-10505A, C3TZ-10505A, C0AF-10505B, C0MF-10505A, FBF-10505A/B, PB7M-10505A, 2900423 (PREMIUM QUALITY/ USA MADE)</p>		

LIGHT SWITCHES

B5010-018	Turn Signal Light Switch	\$73.50
 <p>Universal Turn Signal Switch. Has right turn, left turn, and warning flasher modes. Metal Construction with Color Coded Wire Leads. Fuse, clamp ring, and instruction sheet included. Fits: Mercury, Metropolitan - Pre-1953 Vehicles</p>		

METROPOLITAN

Spark Plug Wire Sets

4 Cyl. Tailored Spark Plug Wire Set		
B1089-001	Original Type Cotton Braid Wire	\$30.00
B1089-001E	EPDM Wire	\$32.75

Battery Cables

B2000-002	Positive Ground Strap	\$9.50
B2089-001	Negative Battery Cable	\$61.75
B2089-002	Switch to Starter Cable	\$22.25

Wiring Harness Metropolitan 1955-1962

B3089-001	Complete Wire Harness	\$912.00
------------------	------------------------------	-----------------

TUNE UP PARTS

Metropolitan 1956 Thru 1963		
	B4001-032	\$11.25
	Points Replaces: #423153, 54413568, 9946	
	B4002-023	\$6.75
	Condenser Replaces: #419022, 420303, 421267, 421487, 423871	
	B4003-056	\$26.75
	Call for Availability Cap Replaces: #422904, 422905	
	B4004-037	\$5.00
	Rotor Replaces: #400051, 405468, 418250	

***For 12-Volt Ignition Coils & Accessories, see p.44**

MG

TUNE UP PARTS

MG 4 Cyl. 1959 Magnette ZB, 1959-1961 Magnette Series ZA, Mark II, MGA-1500,1600 Midget Coupe, 1960-1961 Midget MK I (950 cc), 1961,1962 MK II, 1962-1965 Magnette Mark IV, 1962-1966 1100 (1100cc), 1962-1966 MGB-GT (1800cc), 1962-1966 Midget (1100cc), 1967-1969 Midget (1300cc)		
	B4001-032	\$11.25
	Points Replaces: #423153, 54413568, 9946	
	B4002-023	\$6.75
	Condenser Replaces: #419022, 420303, 421267, 421487, 423871	
	B4003-056	\$26.75
	Call for Availability Cap Replaces: #422904, 422905	
	B4004-037	\$5.00
	Rotor Replaces: #400051, 405468, 418250	

*For 12-Volt Ignition Coils & Accessories, see p.44

ALTERNATORS

	B6001-001	12 Volt Alternator (1 Wire)	\$112.75
	63 Amp, Low Cut In, Specially Built For Tractors, Forklifts, & Other Low Engine Speed Applications		

NASH

TABLE OF CONTENTS

Spark Plug Wire Sets	520
Battery Cables	521
Tune Up Parts	522
Electronic Ignition Conversion Kits	526
Cutout Relays & Voltage Regulators	526
Switches	527
Identification Tags	527
Alternators	528

SPARK PLUG WIRE SETS

Our Spark Plug Wire Sets Come Fully Assembled with the Proper Type Wire & Terminals.

They are Custom Tailored to Look & Fit Like Original Factory Equipment.

Varieties include:

Cotton Braid Wire: Copper Core with a Cotton Jacket.

PVC Wire: Copper Core with a Rubber Jacket.

EPDM Wire (E): Hi Performance Premium Conductor with a Tinned Copper Core, EPDM Insulation, Rubber Jacket.

Suppression Wire (S): for Electronic Ignition and is Spiral Wound, Low-Ohm, with EPDM Silicone Insulation and a Rubber Jacket.

Cotton Braid Suppression Wire (CS): also for Electronic Ignition, as Suppression Wire, but has an additional layer of Cotton Braid & Lacquer to replicate the vintage look, as well.



Nash 1929 Advanced 6 Model 400 Series

Twin Ignition, 6 Cyl. Tailored Spark Plug Wire Set

B1091-006	Original Type Cotton Braid Wire	\$124.75
B1091-006E	EPDM Wire	\$136.00

Nash 1941-1947 Model 600

6 Cyl. Tailored Spark Plug Wire Set

B1091-001	Original Type Cotton Braid Wire	\$50.75
B1091-001E	EPDM Wire	\$55.50
B1091-001S	Suppression Wire	\$55.50
B1091-001CS	Cotton Suppression Wire	\$87.50

Nash 1948-1949 Model 600

6 Cyl. Tailored Spark Plug Wire Set

B1091-002	Original Type PVC Wire	\$46.00
B1091-002E	EPDM Wire	\$55.50
B1091-002S	Suppression Wire	\$55.50

Nash 1946-1954 Ambassador

6 Cyl. Tailored Spark Plug Wire Set

B1091-003	Original Type Cotton Braid Wire	\$50.75
B1091-003E	EPDM Wire	\$55.50
B1091-003S	Suppression Wire	\$55.50
B1091-003CS	Cotton Suppression Wire	\$87.50

Nash 1950-1955 Rambler

6 Cyl. Tailored Spark Plug Wire Set

B1091-004	Original Type PVC Wire	\$46.00
B1091-004E	EPDM Wire	\$55.50
B1091-004S	Suppression Wire	\$55.50

Nash 1950-1955 Statesman

6 Cyl. Tailored Spark Plug Wire Set

B1091-005	Original Type PVC Wire	\$46.00
B1091-005E	EPDM Wire	\$55.50
B1091-005S	Suppression Wire	\$55.50

BATTERY CABLES



Our Battery Cables are made from the Proper Gauge Copper, as either **Black Cotton Braided Wire** or **PVC Wire** (whichever is correct for the application), using Soldered & Heat Sealed Brass or Copper Terminals.

Nash 1927-1930 Standard 6

B2091-001	Negative Battery Cable	\$40.25
------------------	------------------------	----------------

Nash 6 Cyl. 1935 3520, 3580

B2091-002	Negative Battery Cable	\$41.50
------------------	------------------------	----------------

Nash 1936 400

B2000-004	Positive Ground Strap	\$10.50
------------------	-----------------------	----------------

Nash 6 Cyl. Ambassador 1937

B2091-003	Negative Battery Cable	\$40.25
------------------	------------------------	----------------

Nash 8 Cyl. 1938

B2091-004	Negative Battery Cable	\$41.50
------------------	------------------------	----------------

Nash 6 Cyl. 1939 Early

B2091-005	Negative Battery Cable	\$40.25
------------------	------------------------	----------------

Nash Late 1939-1940

B2000-005	Positive Ground Strap	\$12.50
B2091-006	Negative Battery Cable	\$70.00
B2091-007	Switch to Starter Cable	\$29.50

Nash 1941-1947 600

B2000-004	Positive Ground Strap	\$10.50
B2091-008	Negative Battery Cable	\$40.25
B2091-009	Switch to Starter Cable	\$29.50

Nash 1948 600

B2000-004	Positive Ground Strap	\$10.50
B2091-010	Negative Battery Cable	\$47.75
B2091-011	Switch to Starter Cable	\$29.50

Nash 1949 600

B2091-012	Positive Battery Cable	\$30.75
B2091-013	Negative Battery Cable	\$47.75
B2091-014	Switch to Starter Cable	\$29.50

Nash 6 Cyl. Rambler 1950-1951

B2091-015	Positive Battery Cable	\$47.75
B2091-016	Negative Battery Cable	\$39.00
B2091-017	Switch to Starter Cable	\$27.00

Nash 6 Cyl. Rambler 1952

B2091-018	Positive Battery Cable	\$39.00
B2091-019	Negative Battery Cable	\$39.00
B2091-020	Switch to Starter Cable	\$27.00

Nash 6 Cyl. Rambler 1953-1954

B2091-021	Positive Battery Cable	\$27.00
B2091-022	Negative Battery Cable	\$39.00
B2091-023	Switch to Starter Cable	\$27.00

Nash 6 Cyl. Statesman 1950-1951

B2091-024	Positive Battery Cable	\$33.00
B2091-025	Negative Battery Cable	\$45.25
B2091-026	Switch to Starter Cable	\$29.50

Nash Statesman 1952-1954 6 Standard

B2091-027	Positive Battery Cable	\$27.00
B2091-028	Negative Battery Cable	\$55.75
B2091-029	Switch to Starter Cable	\$29.50

Nash Statesman 1952-1954 6 Hydramatic

B2091-030	Positive Battery Cable	\$27.00
B2091-031	Negative Battery Cable	\$47.75
B2091-032	Switch to Starter Cable	\$29.50

Nash 6 Cyl. Ambassador 1941-1947

B2000-004	Positive Ground Strap	\$10.50
B2091-033	Negative Battery Cable	\$63.50
B2091-034	Switch to Starter Cable	\$29.50

Nash 6 Cyl. Ambassador 1948

B2000-004	Positive Ground Strap	\$10.50
B2091-035	Negative Battery Cable	\$55.75
B2091-036	Switch to Starter Cable	\$29.50

Nash Ambassador 1949-1950 6 Standard

B2091-037	Positive Battery Cable	\$30.75
B2091-038	Negative Battery Cable	\$55.75
B2091-039	Switch to Starter Cable	\$29.50

See additional Nash battery cables on the following page.

Nash Ambassador 1950-1951

6 Hydramatic

B2091-040	Positive Battery Cable	\$33.00
B2091-041	Negative Battery Cable	\$42.25
B2091-042	Switch to Starter Cable	\$29.50

Nash Ambassador 1951 6 Standard

B2091-043	Positive Battery Cable	\$33.00
B2091-044	Negative Battery Cable	\$50.00
B2091-045	Switch to Starter Cable	\$29.50

Nash 8 Cyl. Ambassador 1940

B2000-005	Positive Ground Strap	\$12.50
B2091-046	Negative Battery Cable	\$70.00
B2091-047	Switch to Starter Cable	\$37.75

Nash 8 Cyl. Ambassador 1941

B2000-004	Positive Ground Strap	\$10.50
B2091-048	Negative Battery Cable	\$63.50

Nash Ambassador 1940-1941

(Except Ambassador 8)

B2000-005	Positive Ground Strap	\$12.50
B2091-049	Negative Battery Cable	\$70.00
B2091-050	Switch to Starter Cable	\$41.75

Nash 8 Cyl. 1942

B2000-004	Positive Ground Strap	\$10.50
B2091-051	Negative Battery Cable	\$63.50

Nash Ambassador 1952-1954 Standard

B2091-052	Positive Battery Cable	\$30.00
B2091-053	Negative Battery Cable	\$45.25

Nash Ambassador 1952-1954 Hydromatic

B2091-054	Positive Battery Cable	\$30.00
B2091-055	Negative Battery Cable	\$42.25

Nash Rambler 1955

B2091-056	Positive Battery Cable	\$30.00
B2091-057	Negative Battery Cable	\$45.25

Nash Rambler 1955 Deluxe

B2091-058	Positive Battery Cable	\$30.00
B2091-059	Negative Battery Cable	\$33.00

TUNE UP PARTS

Nash 1954-1961 4-Cylinder Metro 540, 560

	B4001-032	\$11.25
	Points Replaces: #423153, 54413568, 9946	
	B4002-023	\$6.75
	Condenser Replaces: #419022, 420303, 421267, 421487, 423871	
	B4004-037	\$5.00
	Rotor Replaces: #400051, 405468, 418250	



*For 12-Volt Ignition Coils & Accessories, see p.44

Nash 6-Cylinder 1928-1937 with Autolite Distributor



	B4001-002	\$14.75
	Points Replaces: #IGW-3028S, 1-31	
	B4002-005	\$9.75
	Condenser Replaces: #2-24, 2-35, 2-22, 2-23	
	B4003-027	\$21.75
	Cap Replaces: #ICB-1240, 3-20	
	B4004-004	\$11.50
	Rotor Premium Grade, Made in the USA Replaces: #4-15, IGB-1239	

*For 6-Volt Ignition Coils & Accessories, see p.44

Nash 1937-1938 6-Cylinder Ambassador with Delco Distributor

	B4002-001	\$4.75
	Condenser Replaces: #1928111, D-203, 1869704, D-200	
	B4004-002	\$5.75
	Rotor Replaces: #820445, D400	

*For 6-Volt Ignition Coils & Accessories, see p.44

Nash 6-Cylinder 1938-1941 with IGE Distributor		
	B4001-002	\$14.75
	Points Replaces: #IGW-3028S, 1-31	
B4002-002		\$4.75
	Condenser	
	Replaces: #2-23, 2-31, 2-32, 2-34, 2-38, 2-42, IAT-2015L, IAT-2015R, IAT-3076AS, IAT-3076BS, IAT-3076D, IAT-3076DS, IAT-3076L, IAT-3076LA, IAT-3076R, IAT-3076RA, IBB-2015L, IBB-2015R, IBB-2042-SS, IBB-2042SS-1, IBB-2042-SS3, IG-2671F, IGH-3076, IGW-3139, 2098058, 3420600	



*For 6-Volt Ignition Coils & Accessories, see p.44

Nash 6-Cylinder 1941-1942 4140, 4240 Models with Delco Distributor		
	B4001-021	\$13.75
	Points Replaces: #1855520, D-109	
	B4002-001	\$4.75
	Condenser Replaces: #1928111, D-203, 1869704, D-200	
	B4004-021	\$14.75
	Rotor Replaces: #816774	
	B4003-059	\$22.50
	Cap Replaces: #816779, 822465, 1831800, 1853240	

Nash 1942 6-Cylinder 4202 with IGI Distributor		
B4002-002		\$4.75
	Condenser	
	Replaces: #2-23, 2-31, 2-32, 2-34, 2-38, 2-42, IAT-2015L, IAT-2015R, IAT-3076AS, IAT-3076BS, IAT-3076D, IAT-3076DS, IAT-3076L, IAT-3076LA, IAT-3076R, IAT-3076RA, IBB-2015L, IBB-2015R, IBB-2042-SS, IBB-2042SS-1, IBB-2042-SS3, IG-2671F, IGH-3076, IGW-3139, 2098058, 3420600	
	B4004-007	\$8.25
	Rotor Premium Grade, Made in the USA Replaces: #4-19	

Nash 6-Cylinder 1939-1942 (with IGS Distributor), 1946-1947 Ambassador		
	B4001-005	\$9.75
	Points Replaces: #1-4, 1-8, 1-9, 1-20, 1-22, 1-45, IAD-3128S, IGP-3028ES, IGP3028FS, IGS2224L, IGW3028AS	
	B4002-006	\$7.50
	Condenser Replaces: #2-31, 2-38, 2-42, 2-95, IAT-1125S, IAT-3076BS, IBB-2042SS-1, IBB-2042-SS3, IG-3927F, IG-3927G, IG-3927K, IG-3927R	
	B4004-007	\$8.25
	Rotor Premium Grade, Made in the USA Replaces: #4-19	
	B4003-007	\$25.00
	Distributor Cap Premium Grade, Made in the USA (Brass Contacts) Replaces: #IGC-1107S, 3-23	

*For 6-Volt Ignition Coils & Accessories, see p.44

Nash 6-Cylinder 1946-1947 (Except Ambassador)		
	B4001-002	\$14.75
	Points Replaces: #IGW-3028S, 1-31	
	B4002-005	\$9.75
	Condenser Replaces: #2-24, 2-35, 2-22, 2-23	
	B4004-004	\$11.50
	Rotor Premium Grade, Made in the USA Replaces: #4-15, IGB-1239	

Nash 1948-1955 6-Cylinder with Delco Distributor (Except Distributor #1110227 & 1955 Ambassador with 112409 Distributor)		
	B4100-001	\$10.50
	PCR Kit Includes: Points (#B4001-001), Condenser (#B4002-001), Rotor (#B4004-002) Replaces: Points - #D100HP, 1855720 Condenser - #1928111, D-203, 1869704, D-200 Rotor - #820445, D400	
	B4003-002	\$20.25
	Distributor Cap Premium Grade, Made in the USA (Brass Contacts) Replaces: #824735, D301	

	B4004-002	\$5.75
	Rotor Replaces: #820445, D400	
	B4007-001	\$11.95
	Cap Clip Short Mount, 1 Used Replaces: #1889967, 1847289, 453844, 453461	
	B4007-002	\$11.95
	Cap Clip Long Mount, 1 Used Replaces: #1889967, 1889999, 453844, 453461	
	B4009-001	\$25.99
	Distributor Bushing & Shim Kit	
B4006-001	Dust Cover	Replaces: #1900119 \$9.99

*For 6-Volt Ignition Coils & Accessories, see p.44

	B4009-001	\$25.99
	Distributor Bushing & Shim Kit	
B4006-001	Dust Cover	Replaces: #1900119 \$9.99

*For 6-Volt Ignition Coils & Accessories, see p.44

Nash 1955 6-Cylinder Ambassador
with Delco Distributor #1112409

	B4001-001	\$4.75
	Points Replaces: #D100HP, 1855720	
	B4002-001	\$4.75
	Condenser Replaces: #1928111, D-203, 1869704, D-200	
	B4003-034	\$18.25
	Cap Replaces: #268574C92	
	B4004-013	\$4.75
	Rotor Premium Grade, Made in the USA Replaces: #D-419R, 1963972	

*For 6-Volt Ignition Coils & Accessories, see p.44

Nash 1948-1955 6-Cylinder
with Delco 1110227 Distributor

	B4001-020	\$14.50
	Points Replaces: #1938340, 1882025, D104P, DR2437	
	B4002-001	\$4.75
	Condenser Replaces: #1928111, D-203, 1869704, D-200	
	B4003-002	\$20.25
	Distributor Cap Premium Grade, Made in the USA (Brass Contacts) Replaces: #824735, D301	
	B4004-002	\$5.75
	Rotor Replaces: #820445, D400	
	B4007-001	\$11.95
	Cap Clip Short Mount, 1 Used Replaces: #1889967, 1847289, 453844, 453461	
	B4007-002	\$11.95
	Cap Clip Long Mount, 1 Used Replaces: #1889967, 1889999, 453844, 453461	



Nash 1956 6-Cylinder 5640

	B4001-013	\$16.25
	Points Replaces: #1938330 (D-103P), 1882024 (D103), 1871678, 1871870, 1918148	
	B4002-001	\$4.75
	Condenser Replaces #1928111, D-203, 1869704, D-200	
	B4003-034	\$18.25
	Cap Replaces: #268574C92	
	B4004-022	\$6.50
	Rotor Replaces: #1924245, D-405	

*For 12-Volt Ignition Coils & Accessories, see p.44



Nash 1956 6-Cylinder 5660	
	B4001-022 \$16.75 Points Replaces: #IGS-2224, 1-44, 2084075
B4002-002 \$4.75	
	Condenser Replaces: #2-23, 2-31, 2-32, 2-34, 2-38, 2-42, IAT-2015L, IAT-2015R, IAT-3076AS, IAT-3076BS, IAT-3076D, IAT-3076DS, IAT-3076L, IAT-3076LA, IAT-3076R, IAT-3076RA, IBB-2015L, IBB-2015R, IBB-2042-SS, IBB-2042SS-1, IBB-2042-SS3, IG-2671F, IGH-3076, IGW-3139, 2098058, 3420600
	B4003-036 \$13.50 Cap Replaces: #IAT-1033, IAT-1033A, IAT-1033C, 3-4, 3-34, 3-37
	B4004-026 \$6.75 Rotor Replaces: #IAU-1016A, 4-4

*For 12-Volt Ignition Coils & Accessories, see p.44

Nash 8-Cylinder 1929-1941 (Except 4203& Models with IGH-407 Distributor)	
	B4001-002 \$14.75 Points Replaces: #IGW-3028S, 1-31
B4002-002 \$4.75	
	Condenser Replaces: #2-23, 2-31, 2-32, 2-34, 2-38, 2-42, IAT-2015L, IAT-2015R, IAT-3076AS, IAT-3076BS, IAT-3076D, IAT-3076DS, IAT-3076L, IAT-3076LA, IAT-3076R, IAT-3076RA, IBB-2015L, IBB-2015R, IBB-2042-SS, IBB-2042SS-1, IBB-2042-SS3, IG-2671F, IGH-3076, IGW-3139, 2098058, 3420600

*For 6-Volt Ignition Coils & Accessories, see p.44

Nash 8-Cylinder 1942	
B4002-002 \$4.75	
	Condenser Replaces: #2-23, 2-31, 2-32, 2-34, 2-38, 2-42, IAT-2015L, IAT-2015R, IAT-3076AS, IAT-3076BS, IAT-3076D, IAT-3076DS, IAT-3076L, IAT-3076LA, IAT-3076R, IAT-3076RA, IBB-2015L, IBB-2015R, IBB-2042-SS, IBB-2042SS-1, IBB-2042-SS3, IG-2671F, IGH-3076, IGW-3139, 2098058, 3420600

	B4003-037 \$36.50 Cap Replaces: #IGP-1003, 3-26
	B4004-027 \$7.75 Rotor Replaces: #4-17

Nash 1955-1956 8-Cylinder (Except 5650, & IBJ Distributor)	
	B4001-034 \$9.00 Points Replaces: #IAZ-2040L, IAZ-2040LS (1-43), IGP-3028YS (1-18), IGW-3028HS (1-24, 1-42), IGW-3028NS, IGW-3028PS (1-30)
B4002-002 \$4.75	
	Condenser Replaces: #2-23, 2-31, 2-32, 2-34, 2-38, 2-42, IAT-2015L, IAT-2015R, IAT-3076AS, IAT-3076BS, IAT-3076D, IAT-3076DS, IAT-3076L, IAT-3076LA, IAT-3076R, IAT-3076RA, IBB-2015L, IBB-2015R, IBB-2042-SS, IBB-2042SS-1, IBB-2042-SS3, IG-2671F, IGH-3076, IGW-3139, 2098058, 3420600
	B4003-038 \$31.75 Cap Replaces: #IAR-1003, 3-2
	B4004-027 \$7.75 Rotor Replaces: #4-17

*For 6-Volt Ignition Coils & Accessories, see p.44

Nash 1956 8 Cylinder with IBJ Distributor	
	B4001-034 \$9.00 Points Replaces: #IAZ-2040L, IAZ-2040LS (1-43), IGP-3028YS (1-18), IGW-3028HS (1-24, 1-42), IGW-3028NS, IGW-3028PS (1-30)
B4002-002 \$4.75	
	Condenser Replaces#2-23, 2-31, 2-32, 2-34, 2-38, 2-42, IAT-2015L, IAT-2015R, IAT-3076AS, IAT-3076BS, IAT-3076D, IAT-3076DS, IAT-3076L, IAT-3076LA, IAT-3076R, IAT-3076RA, IBB-2015L, IBB-2015R, IBB-2042-SS, IBB-2042SS-1, IBB-2042-SS3, IG-2671F, IGH-3076, IGW-3139, 2098058, 3420600
	B4003-038 \$31.75 Cap Replaces: #IAR-1003, 3-2

	B4004-027	\$7.75
	Rotor Replaces: #4-17	

*For 6-Volt Ignition Coils & Accessories, see p.44

Nash 1956 5650		
	B4001-013	\$16.25
	Points Replaces: #1938330 (D-103P), 1882024 (D103), 1871678, 1871870, 1918148	
	B4002-001	\$4.75
	Condenser Replaces: #1928111, D-203, 1869704, D-200	
	B4003-028	\$26.25
	Cap Top Quality USA Made with Brass Contacts Replaces: #1911556, D-302	
	B4004-018	\$5.75
	Rotor Replaces: #1836893	

*For 12-Volt Ignition Coils & Accessories, see p.44

Nash 1957		
	B4001-019	\$6.75
	Points Replaces: #D-106PS	
	B4002-001	\$4.75
	Condenser Replaces: #1928111, D-203, 1869704, D-200	
	B4003-032	\$14.25
	Cap Premium Quality, Brass Contacts Replaces: #1942654, D309	
	B4004-020	\$4.50
	Rotor Replaces: #1852722, 1932015, D-426R	

*For 12-Volt Ignition Coils & Accessories, see p.44

ELECTRONIC IGNITION CONVERSION KITS

Replaces Points & Condenser



Nash 6 Cyl. 1938 with Autolite Distributor # IGC-4729A		
B9600-070A	12 Volt Negative Ground	\$195.95
B9600-070AP6	6 Volt Positive Ground	\$206.45

Nash 6 Cyl. 1939-1942 & 1946-1948 All with Autolite IGS Series Distributor		
B9600-307LS	12 Volt Negative Ground	\$169.45
B9600-307LSP6	6 Volt Positive Ground	\$185.95

Nash 6 Cylinder 1941-1942 4140, 4240 with Delco Distributor		
B9600-309	12 Volt Negative Ground	\$154.95
B9600-309P6	6 Volt Negative Ground	\$169.45

Nash 6 Cyl. 1948-1955 with Delco Distributor (Except 1955 Ambassador with #112409 Distributor)		
B9600-255LS	12 Volt Negative Ground	\$162.45
B9600-255LSP12	12 Volt Positive Ground	\$175.45
B9600-255LSP6	6 Volt Positive Ground	\$175.45



*For Ignition Coils & Accessories,
see p.44

CUTOUT RELAYS & VOLTAGE REGULATORS

Note: Due to modern battery design, voltage regulators can't be used to charge low or dead batteries. Doing so will destroy the voltage regulator and void the warranty.

B8001-001	6-Volt Cutout Relay	\$19.50
15 Amps, 6 Volt Works Positive or Negative Ground Replaces: Autolite - #CB4014, C4012(9-5), C4012(9-4), C4012(9-1), R40061 Delco - #266P, 266N, 265P, 265N, 5015850, 812970, 265J, 820845, 812971, 1116816, 265G, 265H, 1116755, 1116751, 1116809DR, 265B, 1842859, 265C, 1867781, 265F, 265D Fits: Nash - 6, 8 Cyl. 1929-1938		



B8001-002	Electronic Cutout Relay	\$19.50
	25 Amp, Works with 6, 12, or 24 Volts. & Positive or Negative Ground Replaces: Autolite - #CB4014, C4012(9-5), C4012(9-4), C4012(9-1), R40061 Delco - #266P, 266N, 265P, 265N, 5015850, 812970, 265J, 820845, 812971, 1116816, 265G, 265H, 1116755, 1116751, 1116809DR, 265B, 1842859, 265C, 1867781, 265F, 265D Fits: Nash - 6, 8 Cyl. 1929-1938	

6-Volt Saddle Mounted Cutout Relay (Delco Version)		
B8001-004	Premium Quality, Made in the USA	\$122.50
B8001-006	Standard Quality	\$38.59

	Cutout Relay, 25 Amp, 6 Volt, Works Positive or Negative Ground. Replaces: Delco - #266P, 266N, 265P, 265N, 5015850, 812970, 265J, 820845, 812971, 1116816, 265G, 265H, 1116755, 1116751, 1116809DR, 265B, 1842859, 265C, 1867781, 265F, 265D Fits: Nash - 6, 8 Cyl. 1929-1938	
---	---	--

B8002-028	6-Volt Autolite Type Voltage Regulator	\$158.60
------------------	---	-----------------

	6 Volt, 3 Terminal, Flat Mounting Bracket Regulator (Premium Quality Made in the USA) Replaces: Prestolite - #8-117, 8-70, 8-74, GRX-761, VBE-6102A, VBE-6104A, VBO-4601F, VBO-4601K, VBO-4602B, VBO-4602R, VRB-4002C, VRP-4001A, VRP-4001B, VRP-4002D, VRP-4003A, VRP-4003B, VRP-4004A, VRP-4004C, VRP-4004F, VRP-4008A, VRP-6001A, VRP-6001B, VRP-6002A, VRP-6005A, VRP-6101A, VRP-6101B Fits: Nash - 1939 to 1942 With Autolite Generator	
--	---	--

B8002-044	6-Volt Voltage Regulator	\$149.75
------------------	---------------------------------	-----------------

	Positive Ground, 37-41 Amp, Made in the U.S.A. Replaces: Delco - # Delco - #1118202, 1118212, 1118222, 1118226, 1118232, 1118238, 1118276, 1118278, 1118302, 1118314, 1118331, 1118351, 1118360, 1118366, 1118380, 1118382, 1118387, 1118392, 1118393, 1118726, 1118730, 1118731, 1118732, 1118743, 1118828, 1118829, 1118830, 1118834, 1118841, 1118842, 1118846, 1118850, 1118864, 1118865, 1118867, 1118950, 1119272, 5847, 5852, 5871, 5877, 5885, D602, D604, D607, D608, D610, D612 Fits: Nash 1949-1950, 6 cyl (Except 1950 Ambassador) Rambler 1950-1955, 6 cyl (except Gen 1102748)	
---	---	--

B8002-031	6-Volt Autolite Type Voltage Regulator	\$144.88
	6 Volt, 3 Terminal, Flat Mounting Bracket Regulator. Positive Ground. (Premium Quality Made in the USA) Replaces: Delco - #A602, A602M Prestolite - #8-76, 8-762, VBE-6001A, VBE-6101, VBE-6201A, VBO-4602E, VBO-4602V Fits: Nash - 6 Cyl. 1955 Ambassador, Rambler, Statesman (With GGN Series Generator); 6 Cyl. 1952-1955 Rambler, Statesman (With GDZ-Series Generator); 8 Cyl. 1955 Ambassador, Rambler, Statesman (With GGN Series Generator)	

B8002-008	12-Volt Autolite Type Voltage Regulator	\$69.75
------------------	--	----------------

	12 Volt, 3 Terminal, Flat Mounting (Premium Quality, Made in the USA) Replaces: Prestolite - 8-154, 8-414, 8-58, 8-59, 8-722, 8-85, GRX-722, VBO-4201E, VBO-4202A, VBO-4202B, VBO-4202P, VBO-4202R, VR-6301A, VRX-6010, VRX-6010A Delco - 1972029, 1972061, A600, A600M, A605, A605M Fits: Nash - 1956 w/ Autolite Generator	
--	---	--

SWITCHES

B5006-001	Starter Switch (Long Shaft)	\$12.75
------------------	------------------------------------	----------------

	6 or 12 Volt Panel Mounted Manual/Mechanical Push Start Switch Replaces: Delco - #192119, D900, 450C Prestolite - #15-121, 15-122, 15-409, 15-45, 15-47, 15-50, 15-51, SW-2916, SW-4001, SW-4002, SW-4005, SW-4010, SW-4013, SW-4015, SW-4017, SW-4101, SWX-47 Fits: Nash - 1935-1946	
--	--	--

B5010-018	Turn Signal Light Switch	\$73.50
------------------	---------------------------------	----------------

	Universal Turn Signal Switch. Has right turn, left turn, and warning flasher modes. Metal Construction with Color Coded Wire Leads. Fuse, clamp ring, and instruction sheet included. Fits: Pre-1953 Vehicles	
--	--	--

IDENTIFICATION TAGS

B9013-001	Small Autolite I.D. Tag (Blank)	\$7.00
	Small Autolite I.D. Tag (Stamped)	\$14.25

	2 5/16" Long, Black I.D. Tag for Distributors, Starters, & Generators with Rivets	
--	---	--

B9013-002	Large Autolite I.D. Tag (Blank)	\$7.00
	Large Autolite I.D. Tag (Stamped)	\$14.25
		2 15/16" Long, Black I.D. Tag for Distributors, Starters, & Generators with Rivets

Delco Remy

B9013-003	Large Delco Remy I.D. Tag (Blank)	\$9.00
	Large Delco Remy I.D. Tag (Stamped)	\$16.25
		Large Black Delco-Remy I.D. Tag for Distributors, 6 Volt Starters, & 6 Volt Generators with Rivets, 1 1/4" X 2 7/8"

B9013-004	Delco Remy I.D. Tag (Blank)	\$7.00
	Delco Remy I.D. Tag (Stamped)	\$14.25
		Black Delco-Remy I.D. Tag for Distributors, 6 Volt Starters, & 6 Volt Generators with Rivets, 3/4" X 2 5/16"

B9013-005	Red Delco Remy I.D. Tag (Blank)	\$7.00
	Red Delco Remy I.D. Tag (Stamped)	\$14.25
		Red Delco-Remy I.D. Tag for 12 Volt Starters & 12 Volt Generators with Rivets, 3/4" X 2 5/16"

B9013-013	Delco Remy I.D. Tag (Blank)	\$7.00
	Delco Remy I.D. Tag (Stamped)	\$14.25
		Black Delco-Remy I.D. Tag for Distributors, 6 Volt Starters, & 6 Volt Generators with Rivets, 3/4" X 2 5/16"



ALTERNATORS

B6001-001	12 Volt Alternator (1 Wire)	\$112.75
63 Amp, Low Cut In, Specially Built For Tractors, Forklifts, & Other Low Engine Speed Applications		
B6001-005	6 Volt Alternator (1 Wire, Positive Ground)	\$166.50
6 Volt, 40 Amp Alternator with Positive Ground, 1 Wire, 3/8" pulley		

OAKLAND

TABLE OF CONTENTS

Spark Plug Wire Sets	528
Bonding Straps	528
Battery Cables	529
Wire Harnesses	529
Tune Up Parts	529
Switches	530
Identification Tags	530
Alternators	530

SPARK PLUG WIRE SETS

Our Spark Plug Wire Sets Come Fully Assembled with the Proper Type Wire & Terminals.

They are Custom Tailored to Look & Fit Like Original Factory Equipment.

Varieties include:

Cotton Braid Wire: Copper Core with a Cotton Jacket.

Packard 440 Wire (P): Tinned Copper Core with EPDM Silicone Insulation and a Rubber Jacket.



Oakland 1916 Models 32, 32B

6 Cyl. Tailored Spark Plug Wire Set

B1092-001	Original Type Cotton Braid Wire	\$57.50
B1092-001P	Packard 440 Wire	\$163.50

Oakland 1924-1927

6 Cyl. Tailored Spark Plug Wire Set

B1092-002	Original Type Cotton Braid Wire	\$57.50
B1092-002P	Packard 440 Wire	\$163.50

Oakland 1928-1929

6 Cyl. Tailored Spark Plug Wire Set

B1092-003	Original Type Cotton Braid Wire	\$57.50
B1092-003P	Packard 440 Wire	\$163.50

Oakland 1930-1931

8 Cyl. Tailored Spark Plug Wire Set

with Original Distributor Cap

B1092-004	Original Type Cotton Braid Wire	\$69.25
B1092-004P	Packard 440 Wire	\$197.00

with Modern Distributor Cap

B1092-005	Original Type Cotton Braid Wire	\$80.50
B1092-005P	Packard 440 Wire	\$219.00

BONDING STRAPS



Oakland 1928-1929

B9006-003	8" Bonding Strap	\$7.00
------------------	------------------	---------------

BATTERY CABLES



Our Battery Cables are made from the Proper Gauge Copper, as either Black Cotton Braided Wire or PVC Wire (whichever is correct for the application), using Soldered & Heat Sealed Brass or Copper Terminals.

Oakland 1916

B2091-001	Negative Battery Cable	\$40.25
B2092-019	Negative Battery Cable w/ Armor	\$60.25
B2091-002	Positive Battery Cable	\$41.50
B2092-018	Positive Battery Cable w/ Armor	\$76.25
B2092-003	Switch to Starter Cable	\$26.50
B2092-020	Switch to Starter Cable w/ Armor	\$46.50

Oakland 1919

B2092-021	Negative Battery Cable	\$26.25
B2092-022	Positive Battery Cable	\$49.25
B2092-023	Positive Battery Cable w/ Armor	\$69.25
B2092-024	Switch to Starter Cable	\$24.25
B2092-025	Switch to Starter Cable w/ Armor	\$44.25

Oakland 1922

B2092-006	Negative Battery Cable	\$37.25
B2092-007	Positive Battery Cable	\$49.75
B2092-026	Positive Battery Cable w/ Armor	\$69.75
B2092-008	Switch to Starter Cable	\$26.50
B2092-027	Switch to Starter Cable w/ Armor	\$46.50

Oakland 1923

B2092-009	Negative Battery Cable	\$33.00
B2092-010	Switch to Starter Cable	\$29.75

Oakland 1924-1925

B2092-011	Negative Battery Cable	\$26.25
B2092-012	Positive Battery Cable	\$29.75
B2092-013	Switch to Starter Cable	\$25.00

Oakland 1926-1927

B2000-007	Negative Ground Strap	\$14.50
B2092-014	Positive Battery Cable	\$35.00
B2092-015	Switch to Starter Cable	\$24.25

Oakland 1928-1929

B2000-002	Negative Ground Strap	\$9.50
B2092-016	Positive Battery Cable	\$38.00

Oakland 1930-1931

B2000-005	Negative Ground Strap	\$12.50
B2092-017	Positive Battery Cable	\$39.00

Note: 'w/ Armor' means that it comes with Original Armor

WIRING HARNESSES



Our Wire Harnesses are made with our premium cotton braid and/or PVC wire.

They have the correct gauge, color, wire, & fuse holders (if needed).

All terminals are soldered according to the original.

(Harnesses do not include Battery Cables & Spark Plug Wires; however, we can supply these as separate products.)

NO HIDDEN COSTS, NOTHING EXTRA TO BUY!

Oakland 1926 Model 654

B3092-004	Complete Wire Harness	\$338.75
------------------	-----------------------	-----------------

Oakland 1927 Model GO6

B3092-004	Complete Wire Harness	\$338.75
------------------	-----------------------	-----------------

Oakland 1928 & 1929 Model 212, & All American Six

B3092-001	Complete Wire Harness	\$595.25
------------------	-----------------------	-----------------

Oakland 1930

B3092-002	Complete Wire Harness	\$646.75
------------------	-----------------------	-----------------

Oakland 1931 Model 301

B3092-003	Complete Wire Harness	\$595.25
------------------	-----------------------	-----------------

TUNE UP PARTS

Oakland 6 Cylinder 1929

	B4100-001 PCR Kit Includes: Points (#B4001-001), Condenser (#B4002-001), Rotor (#B4004-002) Replaces: Points - #D100HP, 1855720 Condenser - #1928111, D-203, 1869704, D-200 Rotor - #820445, D400	\$10.50
	B4004-002 Rotor Replaces: #820445, D400	\$5.75
	B4003-002 Distributor Cap Premium Grade, Made in the USA (Brass Contacts) Replaces: #824735, D301	\$20.25
	B4007-001 Cap Clip Short Mount, 1 Used Replaces: #1889967, 1847289, 453844, 453461	\$11.95

	B4007-002	\$11.95
	Cap Clip Long Mount, 1 Used Replaces: #1889967, 1889999, 453844, 453461	
	B4008-001	\$14.99
	Distributor Insulator Replaces: #1904376	
	B4009-001	\$25.99
	Distributor Bushing & Shim Kit	
B4006-001	Dust Cover	Replaces: #1900119 \$9.99

*For 6-Volt Ignition Coils & Accessories, see p.44

Oakland 8 Cylinder 1930-1931

	B4001-007	\$49.75
	Points Dual Point set Consists of 1 set each, left & right hand Replaces: #1882022	
	B4002-001	\$4.75
	Condenser Replaces: #1928111, D-203, 1869704, D-200	
	B4003-028	\$26.25
	Cap Top Quality USA Made with Brass Contacts Replaces: #1911556, D-302	
	B4004-018	\$5.75
	Rotor Replaces: #1836893	
	B4007-001	\$11.95
	Cap Clip Short Mount, 1 Used Replaces: #1889967, 1847289, 453844, 453461	
	B4007-002	\$11.95
	Cap Clip Long Mount, 1 Used Replaces: #1889967, 1889999, 453844, 453461	
	B4009-001	\$25.99
	Distributor Bushing & Shim Kit	

*For 6-Volt Ignition Coils & Accessories, see p.44

SWITCHES

B5010-018	Turn Signal Light Switch	\$73.50
	Universal Turn Signal Switch. Has right turn, left turn, and warning flasher modes. Metal Construction with Color Coded Wire Leads. Fuse, clamp ring, and instruction sheet included. Fits: Pre-1953 Vehicles	

IDENTIFICATION TAGS

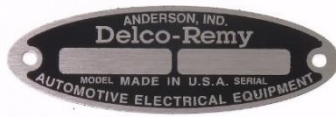
B9013-003	Large Delco Remy I.D. Tag	\$9.00
	(Blank)	
	(Stamped)	\$16.25
	Large Black Delco-Remy I.D. Tag for Distributors, 6 Volt Starters, & 6 Volt Generators with Rivets, 1 1/4" X 2 7/8"	
	B9013-013	Delco Remy I.D. Tag (Blank)
	(Stamped)	\$14.25
	Black Delco-Remy I.D. Tag for Distributors, 6 Volt Starters, & 6 Volt Generators with Rivets, 3/4" 2 5/16"	



ALTERNATORS

B6001-001	12 Volt Alternator (1 Wire)	\$112.75
63 Amp, Low Cut In, Specially Built For Tractors, Forklifts, & Other Low Engine Speed Applications		
B6001-006	6 Volt Alternator	\$166.50
	(1 Wire, Negative Ground)	
6 Volt, 40 Amp Alternator with Negative Ground, 1 Wire		

OLDSMOBILE

TABLE OF CONTENTS

Spark Plug Wire Sets	531
Battery Cables	531
Tune Up Parts	532
Electronic Ignition Conversion Kits	535
Cutout Relays & Voltage Regulators	535
Light Switches	536
Flashers	536
Identification Tags	536
Alternators	536

SPARK PLUG WIRE SETS

Our Spark Plug Wire Sets Come Fully Assembled with the Proper Type Wire & Terminals.

They are Custom Tailored to Look & Fit Like Original Factory Equipment.

Varieties include:

Cotton Braid Wire: Copper Core with a Cotton Jacket.

PVC Wire: Copper Core with a Rubber Jacket.

Packard 440 Wire (P): Tinned Copper Core with EPDM Silicone Insulation and a Rubber Jacket.

Suppression Wire (S): for Electronic Ignition and is Spiral Wound, Low-Ohm, with EPDM Silicone Insulation and a Rubber Jacket.

Cotton Braid Suppression Wire (CS): also for Electronic Ignition, as Suppression Wire, but has an additional layer of Cotton Braid & Lacquer to replicate the vintage look, as well.



Oldsmobile 1949-1955 (8 Cyl.)

8 Cyl. Tailored Spark Plug Wire Set

B1093-004	Original Type Packard 440 Wire	\$204.50
B1093-004E	EPDM Wire	\$78.50
B1093-004S	Suppression Wire	\$78.50

Oldsmobile 1956-1972 (8 Cyl.)

8 Cyl. Tailored Spark Plug Wire Set

B1093-006	Original Type Packard 440 Wire	\$204.50
B1093-006E	EPDM Wire	\$78.50
B1093-006S	Suppression Wire	\$78.50

BATTERY CABLES



Our Battery Cables are made from the Proper Gauge Copper, as either Black Cotton Braided Wire or PVC Wire (whichever is correct for the application), using Soldered & Heat Sealed Brass or Copper Terminals.

Oldsmobile 1929-1932

B2093-001	Positive Battery Cable	\$36.75
B2000-005	Negative Ground Strap	\$12.50

Oldsmobile 1933-1937

B2000-004	Negative Ground Strap	\$10.50
-----------	-----------------------	---------

Oldsmobile 6 Cyl. 1940

B2093-002	Positive Battery Cable	\$30.75
B2093-003	Negative Battery Cable	\$33.00

Oldsmobile 6 Cyl. 1941-1948

B2093-004	Positive Battery Cable	\$30.75
B2093-005	Negative Battery Cable	\$30.75

Oldsmobile 6 Cyl. 1949-1950

B2093-006	Positive Battery Cable	\$39.00
B2093-007	Negative Battery Cable	\$30.75

Oldsmobile 8 Cyl. 1939-1940

B2093-008	Positive Battery Cable	\$32.25
B2093-009	Negative Battery Cable	\$33.00

Oldsmobile 8 Cyl. 1941-1948

B2093-010	Positive Battery Cable	\$30.75
B2093-011	Negative Battery Cable	\$30.75

Oldsmobile 8 Cyl. 1949

B2093-012	Positive Battery Cable	\$45.25
B2093-013	Negative Battery Cable	\$33.00

Oldsmobile 8 Cyl. 1950-1952

B2093-014	Positive Battery Cable	\$45.25
B2093-015	Negative Battery Cable	\$25.50

Oldsmobile 1926

6 Cyl. Tailored Spark Plug Wire Set

B1093-005	Original Type Cotton Braid Wire	\$57.50
-----------	---------------------------------	---------

Oldsmobile 1931

6 Cyl. Tailored Spark Plug Wire Set

B1093-001	Original Type Cotton Braid Wire	\$50.75
B1093-001P	Packard 440 Wire	\$144.50
B1093-001S	Suppression Wire	\$55.50
B1093-001CS	Cotton Suppression Wire	\$87.50

Oldsmobile 1940-1950 (6 Cyl.)

6 Cyl. Tailored Spark Plug Wire Set

B1093-002	Original Type Cotton Braid Wire	\$50.75
B1093-002P	Packard 440 Wire	\$144.50

Oldsmobile 1940-1948 (8 Cyl.)

8 Cyl. Tailored Spark Plug Wire Set

B1093-003	Original Type Cotton Braid Wire	\$72.00
B1093-003P	Packard 440 Wire	\$204.50
B1093-003S	Suppression Wire	\$78.50
B1093-003CS	Cotton Suppression Wire	\$124.25

Oldsmobile 8 Cyl. 1953

B2093-016	Positive Battery Cable	\$45.25
B2093-017	Negative Battery Cable	\$33.00

Oldsmobile 8 Cyl. 1954

B2093-018	Positive Battery Cable	\$30.00
B2000-009	Negative Ground Strap	\$17.00
B2093-019	Switch to Starter Cable	\$29.75

TUNE UP PARTS

Oldsmobile 6 Cylinder 1928-1935

	B4001-021 Points Replaces: #1855520, D-109	\$13.75
	B4002-001 Condenser Replaces: #1928111, D-203, 1869704, D-200	\$4.75
	B4004-021 Rotor Replaces: #816774	\$14.75
	B4003-059 Cap Replaces: #816779, 822465, 1831800, 1853240	\$22.50

*For 6-Volt Ignition Coils & Accessories, see p.44

Oldsmobile 6 Cylinder 1936

	B4001-006 Points Replaces: #1882022	\$11.75
	B4002-001 Condenser Replaces: #1928111, D-203, 1869704, D-200	\$4.75
	B4003-002 Distributor Cap Premium Grade, Made in the USA (Brass Contacts) Replaces: #824735, D301	\$20.25
	B4004-002 Rotor Replaces: #820445, D400	\$5.75

	B4007-001 Cap Clip Short Mount, 1 Used Replaces: #1889967, 1847289, 453844, 453461	\$11.95
	B4007-002 Cap Clip Long Mount, 1 Used Replaces: #1889967, 1889999, 453844, 453461	\$11.95
	B4009-001 Distributor Bushing & Shim Kit	\$25.99





B4006-001	Dust Cover Replaces: #1900119	\$9.99
------------------	--------------------------------------	---------------

*For 6-Volt Ignition Coils & Accessories, see p.44



Oldsmobile 6 Cylinder 1937-1950

	B4001-013 Points Replaces: #1938330 (D-103P), 1882024 (D103), 1871678, 1871870, 1918148	\$16.25
	B4002-001 Condenser Replaces: #1928111, D-203, 1869704, D-200	\$4.75
	B4003-002 Distributor Cap Premium Grade, Made in the USA (Brass Contacts) Replaces: #824735, D301	\$20.25
	B4004-002 Rotor Replaces: #820445, D400	\$5.75
	B4007-001 Cap Clip Short Mount, 1 Used Replaces: #1889967, 1847289, 453844, 453461	\$11.95
	B4007-002 Cap Clip Long Mount, 1 Used Replaces: #1889967, 1889999, 453844, 453461	\$11.95
	B4009-001 Distributor Bushing & Shim Kit	\$25.99
B4006-001	Dust Cover Replaces: #1900119	\$9.99

*For 6-Volt Ignition Coils & Accessories, see p.44

Oldsmobile 6 Cylinder 1964-1965 (V6)		
	B4001-019	\$6.75
	Points Replaces: #D-106PS	
	B4002-012	\$4.75
	Condenser Replaces: #D205	
	B4003-029	\$21.75
	Cap Replaces: #1957693	
	B4004-017	\$7.75
	Rotor Replaces: #1957684, D-413	

Oldsmobile 6 Cylinder 1966-1969		
	B4001-030	\$4.75
	Points Replaces: #1954557, D-108P	
	B4002-012	\$4.75
	Condenser Replaces: #D205	
	B4004-013	\$4.75
	Rotor Premium Grade, Made in the USA Replaces: #D-419R, 1963972	
	B4003-021	\$8.75
	Distributor Cap Replaces: #1954569, D-316	
B4006-004	Dust Cover	Replaces: #1960325 \$16.99



Oldsmobile 8 Cylinder 1932-1935		
	B4001-007	\$49.75
	Points Dual Point set Consists of 1 set each, left & right hand Replaces: #1882022	
	B4002-001	\$4.75
	Condenser Replaces: #1928111, D-203, 1869704, D-200	
	B4003-028	\$26.25
	Cap Top Quality USA Made with Brass Contacts Replaces: #1911556, D-302	

	B4004-018	\$5.75
	Rotor Replaces: #1836893	
	B4007-001	\$11.95
	Cap Clip Short Mount, 1 Used Replaces: #1889967, 1847289, 453844, 453461	
	B4007-002	\$11.95
	Cap Clip Long Mount, 1 Used Replaces: #1889967, 1889999, 453844, 453461	

*For 6-Volt Ignition Coils & Accessories, see p.44



Oldsmobile 8 Cylinder 1936		
	B4001-006	\$11.75
	Points Replaces: #1882022	
	B4002-001	\$4.75
	Condenser Replaces: #1928111, D-203, 1869704, D-200	
	B4003-028	\$26.25
	Cap Top Quality USA Made with Brass Contacts Replaces: #1911556, D-302	
	B4004-018	\$5.75
	Rotor Replaces: #1836893	
	B4007-001	\$11.95
	Cap Clip Short Mount, 1 Used Replaces: #1889967, 1847289, 453844, 453461	
	B4007-002	\$11.95
	Cap Clip Long Mount, 1 Used Replaces: #1889967, 1889999, 453844, 453461	

*For 6-Volt Ignition Coils & Accessories, see p.44

Oldsmobile 8 Cylinder 1937-1950		
	B4001-013	\$16.25
	Points Replaces: #1938330 (D-103P), 1882024 (D103), 1871678, 1871870, 1918148	
	B4002-001	\$4.75
	Condenser Replaces: #1928111, D-203, 1869704, D-200	

	B4003-028	\$26.25
Cap Top Quality USA Made with Brass Contacts Replaces: #1911556, D-302		
	B4004-018	\$5.75
Rotor Replaces: #1836893		
	B4007-001	\$11.95
Cap Clip Short Mount, 1 Used Replaces: #1889967, 1847289, 453844, 453461		
	B4007-002	\$11.95
Cap Clip Long Mount, 1 Used Replaces: #1889967, 1889999, 453844, 453461		
	B4009-001	\$25.99
Distributor Bushing & Shim Kit		

*For 6-Volt Ignition Coils & Accessories, see p.44

Oldsmobile 8 Cylinder 1951-1952		
	B4001-013	\$16.25
Points Replaces: #1938330 (D-103P), 1882024 (D103), 1871678, 1871870, 1918148		
	B4002-001	\$4.75
Condenser Replaces: #1928111, D-203, 1869704, D-200		
	B4003-031	\$17.50
Cap Replaces: #O-305		
	B4004-019	\$10.50
Rotor Replaces: #1917249, D-403		

*For 6-Volt Ignition Coils & Accessories, see p.44

Oldsmobile 8 Cylinder 1953-Early 1954		
	B4001-013	\$16.25
Points Replaces: #1938330 (D-103P), 1882024 (D103), 1871678, 1871870, 1918148		
	B4002-001	\$4.75
Condenser Replaces: #1928111, D-203, 1869704, D-200		
	B4003-031	\$17.50
Cap Replaces: #O-305		
	B4004-019	\$10.50
Rotor Replaces: #1917249, D-403		

Oldsmobile 8 Cylinder Late 1954-1955		
	B4001-013	\$16.25
Points Replaces: #1938330 (D-103P), 1882024 (D103), 1871678, 1871870, 1918148		
	B4002-001	\$4.75
Condenser Replaces: #1928111, D-203, 1869704, D-200		
	B4003-031	\$17.50
Cap Replaces: #O-305		
	B4004-023	\$4.75
Rotor Replaces: #1927393, D-407		

Oldsmobile 8 Cylinder 1956-1973 (Except F-85, Cutlass)		
	B4001-019	\$6.75
Points Replaces: #D-106PS		

	B4002-016	\$4.75
	Condenser Replaces: #1932004, D-204	
	B4003-032	\$14.25
	Cap Premium Quality, Brass Contacts Replaces: #1942654, D309	
	B4004-020	\$4.50
	Rotor Replaces: #1852722, 1932015, D-426R	

Oldsmobile 8 Cylinder 1974 without H.E.I.		
	B4001-033	\$26.50
	Points	
	B4003-032	\$14.25
	Cap Premium Quality, Brass Contacts Replaces: #1942654, D309	
	B4004-020	\$4.50
	Rotor Replaces: #1852722, 1932015, D-426R	

ELECTRONIC IGNITION CONVERSION KITS

Replaces Points & Condenser



Oldsmobile 4 Cyl. 1967-1973 with Bosch Distributor		
B9600-097V	12 Volt Negative Ground	\$110.95
Oldsmobile 6 Cylinder 1928-1935		
B9600-309	12 Volt Negative Ground	\$154.95
B9600-309P6	6 Volt Positive Ground	\$169.45
Oldsmobile 6 Cyl. 1964-1965 with Odd Fire Engine		
B9600-016	12 Volt Negative Ground	\$139.95
Oldsmobile 6 Cyl. 1966-1974 All		
B9600-013A	12 Volt Negative Ground	\$124.95

Oldsmobile 8 Cyl. 1940-1955 Lobe Sensor Version		
B9600-259LS	12 Volt Negative Ground	\$132.95
Oldsmobile 8 Cyl. 1940-1955		
B9600-184	12 Volt Negative Ground	\$154.95
B9600-184N6	6 Volt Negative Ground	\$169.45
Oldsmobile 8 Cyl. 1956-1974 Lobe Sensor Version		
B9600-021LS	12 Volt Negative Ground	\$132.95
B9600-021LSII	12 Volt Negative Ground with Upgraded Current Protection	\$175.95
Oldsmobile 8 Cyl. 1956-1974 All		
B9600-021	12 Volt Negative Ground	\$117.95



***For Ignition Coils & Accessories, see p.44**

CUTOUT RELAYS & VOLTAGE REGULATORS

Note: Due to modern battery design, voltage regulators can't be used to charge low or dead batteries. Doing so will destroy the voltage regulator and void the warranty.

B8001-001	Cutout Relay	\$19.50
------------------	---------------------	----------------



15 Amps, 6 Volt Works Positive or Negative Ground
Replaces: **Autolite** - #CB4014, C4012(9-5), C4012(9-4), C4012(9-1), R40061
Delco - #266P, 266N, 265P, 265N, 5015850, 812970, 265J, 820845, 812971, 1116816, 265G, 265H, 1116755, 1116751, 1116809DR, 265B, 1842859, 265C, 1867781, 265F, 265D
Fits: **Oldsmobile** - 6, 8 Cyl. 1928-1936

B8001-002	Electronic Cutout Relay	\$19.50
------------------	--------------------------------	----------------





25 Amp, Works with 6, 12, or 24 Volts. & Positive or Negative Ground
Replaces: **Autolite** - #CB4014, C4012(9-5), C4012(9-4), C4012(9-1), R40061
Delco - #266P, 266N, 265P, 265N, 5015850, 812970, 265J, 820845, 812971, 1116816, 265G, 265H, 1116755, 1116751, 1116809DR, 265B, 1842859, 265C, 1867781, 265F, 265D
Fits: **Oldsmobile** - 6, 8 Cyl. 1928-1936

6-Volt Saddle Mounted Cutout Relay (Delco Version)		
B8001-004	Premium Quality, Made in the USA	\$122.50
B8001-006	Standard Quality	\$38.59



Cutout Relay, 25 Amp, 6 Volt, Works Positive or Negative Ground.
Replaces: **Delco** - #266P, 266N, 265P, 265N, 5015850, 812970, 265J, 820845, 812971, 1116816, 265G, 265H, 1116755, 1116751, 1116809DR, 265B, 1842859, 265C, 1867781, 265F, 265D
Fits: **Oldsmobile** - 6, 8 Cyl. 1928-1936

6-Volt Delco Type Voltage Regulator		
B8002-001	Premium Quality, Made in the USA	\$87.75
B8002-042	Standard Quality	\$34.75
	6-Volt, 3-Terminal, 32-42 Amps, Negative Ground, Flat Mounting Bracket, A-Circuit Replaces: Delco - 1118201, 1118300, 1118301, 1118357, 1118364, 1118721, 1118843, 1118847, 1118869, 1118872, D601, D614, D653 Fits: Oldsmobile - 1940-1948	

B8002-006	12-Volt Voltage Regulator	\$67.50
	12 Volt, 3 Terminal, Negative Ground, Voltage Regulator Fits: Oldsmobile - 1953-1962 PREMIUM QUALITY - USA MADE	

B8002-004	6-Volt Voltage Regulator	\$142.75
	6 Volt, 3 Terminal, Negative Ground, Voltage Regulator Fits: Oldsmobile - 1949-1952 All Replaces Delco #1118201, 1118207, 1118211, 1118216, 1118221, 1118233, 1118237, 1118242, 1118272, 1118301, 1118311, 1118313, 1118343, 1118349, 1118361, 1118720, 1118847, 1118866, 1118869, 1118872, 1118921, 5547, 5587, 5599, 5809, 5819, 5854, 5872, 5873, 5875, 5878, D601, D614, D653 PREMIUM QUALITY - USA MADE	

ALTERNATOR VOLTAGE REGULATORS

B8002-030	12-Volt Alternator Voltage Regulator	\$14.50
	Heavy Duty, 12 Volt, Negative Ground Alternator Voltage Regulator. This external voltage regulator has 4 spade terminals (field, 2, 3, 4). It is designed for 'B' type circuits in negative ground systems. This is designed for use only in 12 volt systems. For Delco 10DN/ 20DN Fits: Oldsmobile - 6, 8 Cyl. 1963-1964; 6, 8 Cyl. 1965; 6, 8 Cyl. 1966-1969; 6, 8 Cyl. 1970-1972 (excluding 442) Replaces: Delco - #D630, D635, D663, 1119513, 1119515, 1119508, 1119519, D663, 1119502, 1119516, 1119506, 1119512, 1119515	

LIGHT SWITCHES

B5010-018	Turn Signal Light Switch	\$73.50
	Universal Turn Signal Switch. Has right turn, left turn, and warning flasher modes. Metal Construction with Color Coded Wire Leads. Fuse, clamp ring, and instruction sheet included. Fits: Pre-1953 Vehicles	

FLASHERS

B9017-040	6-Volt Thermal Flasher	\$9.75
	6-Volt Thermal Flasher, Three Terminal Replaces: #535 Oldsmobile Fits: 1946-52	

IDENTIFICATION TAGS

B9013-003	Large Delco Remy I.D. Tag (Blank)	\$9.00
	(Stamped)	\$16.25
	Large Black Delco-Remy I.D. Tag for Distributors, 6 Volt Starters, & 6 Volt Generators with Rivets, 1 1/4" X 2 7/8"	

B9013-004	Delco Remy I.D. Tag (Blank)	\$7.00
	(Stamped)	\$14.25
	Black Delco-Remy I.D. Tag for Distributors, 6 Volt Starters, & 6 Volt Generators with Rivets, 3/4" 2 5/16"	

B9013-005	Red Delco Remy I.D. Tag (Blank)	\$7.00
	(Stamped)	\$14.25
	Red Delco-Remy I.D. Tag for 12 Volt Starters & 12 Volt Generators with Rivets, 3/4" 2 5/16"	

B9013-013	Delco Remy I.D. Tag (Blank)	\$7.00
	(Stamped)	\$14.25
	Black Delco-Remy I.D. Tag for Distributors, 6 Volt Starters, & 6 Volt Generators with Rivets, 3/4" 2 5/16"	

ALTERNATORS

B6001-001	12 Volt Alternator (1 Wire)	\$112.75	
63 Amp, Low Cut In, Specially Built For Tractors, Forklifts, & Other Low Engine Speed Applications			
B6001-002	12 Volt Alternator (1 Wire/ 3 Wire)	\$118.75	
63 Amp, With 1 Wire Or 3 Wire For Warning Lamp On Automobiles & Trucks			

OVERLAND

Overland 1915 Spark Plug Wire Set

4 Cyl. Tailored Spark Plug Wire Set		
B1094-001	Original Type Cotton Braid Wire	\$46.00
B1094-001E	EPDM Wire	\$50.25

PACKARD

TABLE OF CONTENTS

Spark Plug Wire Sets	537
Battery Cables	538
Tune Up Parts	539
Electronic Ignition Conversion Kits	543
Cutout Relays & Voltage Regulators	543
Identification Tags	544
Switches	544
Alternators	544

SPARK PLUG WIRE SETS

Our Spark Plug Wire Sets Come Fully Assembled with the Proper Type Wire & Terminals.

They are Custom Tailored to Look & Fit Like Original Factory Equipment.

Varieties include:

Cotton Braid Wire: Copper Core with a Cotton Jacket.

PVC Wire: Copper Core with a Rubber Jacket.

EPDM Wire (E): Hi Performance Premium Conductor with a Tinned Copper Core, EPDM Silicone Insulation, and a Rubber Jacket.

Packard 440 Wire (P): Tinned Copper Core with EPDM Silicone Insulation.

Suppression Wire (S): for Electronic Ignition and is Spiral Wound, Low-Ohm, with EPDM Silicone Insulation and a Rubber Jacket.

Cotton Braid Suppression Wire (CS): also for Electronic Ignition, as Suppression Wire, but has an additional layer of Cotton Braid & Lacquer to replicate the vintage look, as well.



6-Cylinder

Packard 1923-1928 Model 126, 426, 526

With 288 CI Motor

6 Cyl. Tailored Spark Plug Wire Set

B1095-001	Original Type Cotton Braid Wire	\$54.50
B1095-001E	EPDM Wire	\$59.50
B1095-001P	Packard 440 Wire	\$155.00

Packard 1940-1947 Model 110

6 Cyl. Tailored Spark Plug Wire Set

B1095-002	Original Type Cotton Braid Wire	\$50.75
B1095-002E	EPDM Wire	\$55.50
B1095-002P	Packard 440 Wire	\$144.50
B1095-002S	Suppression Wire	\$55.50
B1095-002CS	Cotton Suppression Wire	\$87.50

Packard 1937-1940 Model 115

6 Cyl. Tailored Spark Plug Wire Set

B1095-003	Original Type Cotton Braid Wire	\$50.75
B1095-003E	EPDM Wire	\$55.50
B1095-003P	Packard 440 Wire	\$144.50
B1095-003S	Suppression Wire	\$55.50
B1095-003CS	Cotton Suppression Wire	\$87.50

8-Cylinder

Packard 1936-1942 Model 120C (JR8)

8 Cyl. Tailored Spark Plug Wire Set

B1095-004	Original Type Cotton Braid Wire	\$68.00
B1095-004E	EPDM Wire	\$74.00
B1095-004P	Packard 440 Wire	\$192.50
B1095-004S	Suppression Wire	\$74.00
B1095-004CS	Cotton Suppression Wire	\$117.25

Packard 1936 Model 1400 & 1937 Super 8 Model 1500

320 Cubic Inch Straight Eight

8 Cyl. Tailored Spark Plug Wire Set

B1095-011	Original Type Cotton Braid Wire	\$68.00
B1095-011E	EPDM Wire	\$74.00
B1095-011P	Packard 440 Wire	\$192.50

Packard 1940-1948 Super 8 (356 CI)

8 Cyl. Tailored Spark Plug Wire Set

B1095-005	Original Type Cotton Braid Wire	\$68.00
B1095-005E	EPDM Wire	\$74.00
B1095-005P	Packard 440 Wire	\$192.50
B1095-005S	Suppression Wire	\$74.00
B1095-005CS	Cotton Suppression Wire	\$117.25

Packard 1940-1942 Custom 8

8 Cyl. Tailored Spark Plug Wire Set

B1095-006	Original Type Cotton Braid Wire	\$68.00
B1095-006E	EPDM Wire	\$74.00
B1095-006P	Packard 440 Wire	\$192.50
B1095-006S	Suppression Wire	\$74.00
B1095-006CS	Cotton Suppression Wire	\$117.25

Packard 1942-1947 Clipper 8 (282" CI)

8 Cyl. Tailored Spark Plug Wire Set

B1095-007	Original Type Cotton Braid Wire	\$68.00
B1095-007E	EPDM Wire	\$74.00
B1095-007P	Packard 440 Wire	\$192.50
B1095-007S	Suppression Wire	\$74.00
B1095-007CS	Cotton Suppression Wire	\$117.25

Packard 1948-1950 Standard 8

8 Cyl. Tailored Spark Plug Wire Set

B1095-008	Original Type Cotton Braid Wire	\$68.00
B1095-008E	EPDM Wire	\$74.00
B1095-008P	Packard 440 Wire	\$192.50
B1095-008S	Suppression Wire	\$74.00
B1095-008CS	Cotton Suppression Wire	\$117.25

Packard 1951-1954

8 Cyl. Tailored Spark Plug Wire Set

B1095-009	Original Type PVC Wire	\$61.75
B1095-009E	EPDM Wire	\$74.00
B1095-009P	Packard 440 Wire	\$192.50
B1095-009S	Suppression Wire	\$74.00

Packard 1956 Caribbean

8 Cyl. Tailored Spark Plug Wire Set

B1095-013	Original Type Packard 440 Wire	\$192.50
B1095-013E	EPDM Wire	\$74.00

12-Cylinder

Packard 1929-1931 Twelve (Twin Six)

12 Cyl. Tailored Spark Plug Wire Set

B1095-012	Original Type Cotton Braid Wire	\$101.00
B1095-012E	EPDM Wire	\$110.50
B1095-012P	Packard 440 Wire	\$286.00

Packard 1932-1939 Twelve

12 Cyl. Tailored Spark Plug Wire Set

B1095-010	Original Type Cotton Braid Wire	\$124.75
B1095-010E	EPDM Wire	\$136.00
B1095-010P	Packard 440 Wire	\$354.00

BATTERY CABLES



Our Battery Cables are made from the Proper Gauge Copper, as either Black Cotton Braided Wire or PVC Wire (whichever is correct for the application), using Soldered & Heat Sealed Brass or Copper Terminals.

Packard 1928-1934

(Except 901, 902, 903, & 904)

B2000-004	Positive Ground Strap	\$10.50
------------------	-----------------------	----------------

Packard 1932 Model 901

B2095-001	Negative Battery Cable	\$31.00
------------------	------------------------	----------------

Packard 1932 Model 902

B2095-002	Negative Battery Cable	\$31.00
------------------	------------------------	----------------

Packard 1932 Model 903

B2095-003	Negative Battery Cable	\$31.00
------------------	------------------------	----------------

Packard 1932 Model 904

B2095-004	Negative Battery Cable	\$31.00
------------------	------------------------	----------------

Packard 8 Cyl. 1935-1936

B2000-006	Positive Ground Strap	\$13.50
------------------	-----------------------	----------------

Packard 1935-1936 Model 12

B2000-006	Positive Ground Strap	\$13.50
------------------	-----------------------	----------------

Packard 1935-1936 Model 120

B2000-004	Positive Ground Strap	\$10.50
------------------	-----------------------	----------------

Packard 6 Cyl. 1937 Model 115

B2095-022	Positive Battery Cable	\$30.00
B2095-023	Negative Battery Cable	\$60.00

Packard 1937 Super 8

B2000-006	Positive Ground Strap	\$13.50
------------------	-----------------------	----------------

Packard 1938-1939

B2000-004	Positive Ground Strap	\$10.50
------------------	-----------------------	----------------

Packard 6 Cyl. 1940-1941

B2000-004	Positive Ground Strap	\$10.50
B2095-005	Negative Battery Cable	\$73.00

Packard 6 Cyl. 1942

B2000-004	Positive Ground Strap	\$10.50
B2095-006	Negative Battery Cable	\$73.00

Packard 6 Cyl. 1942-1947 Clipper

B2095-007	Positive Battery Cable	\$41.50
B2095-008	Negative Battery Cable	\$41.50

Packard 8 Cyl. 1940-1941 Model 120

B2000-004	Positive Ground Strap	\$10.50
B2095-009	Negative Battery Cable	\$73.00

Packard 8 Cyl. 1940-1941 Super & Custom

B2000-004	Positive Ground Strap	\$10.50
B2095-010	Negative Battery Cable	\$73.00

Packard 1942 Model 110

B2000-004	Positive Ground Strap	\$10.50
------------------	-----------------------	----------------

Packard 8 Cyl. 1942 Model 120 & Custom 8

B2000-004	Positive Ground Strap	\$10.50
B2095-011	Negative Battery Cable	\$73.00

Packard 8 Cyl. 1942 Model 160 & 180

B2000-004	Positive Ground Strap	\$10.50
B2095-012	Negative Battery Cable	\$36.00

Packard 8 Cyl. 1942 Super 8, Model 160, & 180 Convertible

B2000-004	Positive Ground Strap	\$10.50
B2095-013	Negative Battery Cable	\$80.50

Packard 8 Cyl. 1942-1947 Clipper & Super 8

B2095-014	Positive Battery Cable	\$41.50
B2095-015	Negative Battery Cable	\$41.50

Packard 8 Cyl. 1948-1950 Standard & Super 8

B2095-016	Positive Battery Cable	\$41.50
B2095-017	Negative Battery Cable	\$41.50

Packard 8 Cyl. 1948-1950 Custom 8

B2095-008	Positive Battery Cable	\$41.50
B2095-019	Negative Battery Cable	\$37.00

Packard 1951-1954

B2000-009	Positive Ground Strap	\$17.00
B2095-020	Negative Battery Cable	\$38.75

Packard 1955

B2000-008	Positive Ground Strap	\$15.50
B2095-021	Negative Battery Cable	\$27.25

TUNE UP PARTS

Packard 6 Cylinder 1937-1938 with Delco Distributor

	B4001-013 Points Replaces: #1938330 (D-103P), 1882024 (D103), 1871678, 1871870, 1918148	\$16.25
	B4002-001 Condenser Replaces: #1928111, D-203, 1869704, D-200	\$4.75
	B4003-002 Distributor Cap Premium Grade, Made in the USA (Brass Contacts) Replaces: #824735, D301	\$20.25
	B4004-002 Rotor Replaces: #820445, D400	\$5.75
	B4007-001 Cap Clip Short Mount, 1 Used Replaces: #1889967, 1847289, 453844, 453461	\$11.95
	B4007-002 Cap Clip Long Mount, 1 Used Replaces: #1889967, 1889999, 453844, 453461	\$11.95
	B4009-001 Distributor Bushing & Shim Kit	\$25.99
B4006-001	Dust Cover Replaces: #1900119	\$9.99

*For 6-Volt Ignition Coils & Accessories, see p.44

Packard 6 Cylinder 1937-1938 with Autolite Distributor

	B4001-002 Points Replaces: #IGW-3028S, 1-31	\$14.75
---	---	----------------

	B4002-006 Condenser Replaces: #2-31, 2-38, 2-42, 2-95, IAT-1125S, IAT-3076BS, IBB-2042SS-1, IBB-2042-SS3, IG-3927F, IG-3927G, IG-3927K, IG-3927R	\$7.50
	B4004-002 Rotor Replaces: #820445, D400	\$5.75
	B4003-007 Distributor Cap Premium Grade, Made in the USA (Brass Contacts) Replaces: #IGC-1107S, 3-23	\$25.00

*For 6-Volt Ignition Coils & Accessories, see p.44

Packard 6 Cylinder 1939

	B4001-005 Points Replaces: #1-4, 1-8, 1-9, 1-20, 1-22, 1-45, IAD-3128S, IGP-3028ES, IGP3028FS, IGS2224L, IGW3028AS	\$9.75
	B4002-006 Condenser #2-31, 2-38, 2-42, 2-95, IAT-1125S, IAT-3076BS, IBB-2042SS-1, IBB-2042-SS3, IG-3927F, IG-3927G, IG-3927K, IG-3927R	\$7.50
	B4004-007 Rotor Premium Grade, Made in the USA Replaces: #4-19	\$8.25
	B4003-007 Distributor Cap Premium Grade, Made in the USA (Brass Contacts) Replaces: #IGC-1107S, 3-23	\$25.00

*For 6-Volt Ignition Coils & Accessories, see p.44

Packard 6 Cylinder 1940

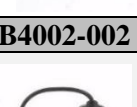
	B4001-002 Points Replaces: #IGW-3028S, 1-31	\$14.75
	B4002-002 Condenser Replaces: #2-23, 2-31, 2-32, 2-34, 2-38, 2-42, IAT-2015L, IAT-2015R, IAT-3076AS, IAT-3076BS, IAT-3076D, IAT-3076DS, IAT-3076L, IAT-3076LA, IAT-3076R, IAT-3076RA, IBB-2015L, IBB-2015R, IBB-2042-SS, IBB-2042SS-1, IBB-2042-SS3, IG-2671F, IGH-3076, IGW-3139, 2098058, 3420600	\$4.75

	B4004-004	\$11.50
	Rotor Premium Grade, Made in the USA Replaces: #4-15, IGB-1239	



*For 6-Volt Ignition Coils & Accessories, see p.44

Packard 6 Cylinder 1941-1947 with Delco Distributor		
	B4100-001	\$10.50
	PCR Kit Includes: Points (#B4001-001), Condenser (#B4002-001), Rotor (#B4004-002) Replaces: Points - #D100HP, 1855720 Condenser - #1928111, D-203, 1869704, D-200 Rotor - #820445, D400	
	B4004-002	\$5.75
	Rotor Replaces: #820445, D400	
	B4003-002	\$20.25
	Distributor Cap Premium Grade, Made in the USA (Brass Contacts) Replaces: #824735, D301	
	B4007-001	\$11.95
	Cap Clip Short Mount, 1 Used Replaces: #1889967, 1847289, 453844, 453461	
	B4007-002	\$11.95
	Cap Clip Long Mount, 1 Used Replaces: #1889967, 1889999, 453844, 453461	
	B4008-001	\$14.99
	Distributor Insulator Replaces: #1904376	
	B4009-001	\$25.99
	Distributor Bushing & Shim Kit	
B4006-001	Dust Cover Replaces: #1900119	\$9.99



*For 6-Volt Ignition Coils & Accessories, see p.44

Packard 6 Cylinder 1941-1947 with Autolite Distributor		
	B4001-005	\$9.75
	Points Replaces: #1-4, 1-8, 1-9, 1-20, 1-22, 1- 45, IAD-3128S, IGP-3028ES, IGP3028FS, IGS2224L, IGW3028AS	
	B4002-006	\$7.50
	Condenser Replaces: #2-31, 2-38, 2-42, 2-95, IAT- 1125S, IAT-3076BS, IBB-2042SS-1, IBB-2042-SS3, IG-3927F, IG-3927G, IG- 3927K, IG-3927R	
	B4004-007	\$8.25
	Rotor Premium Grade, Made in the USA Replaces: #4-19	
	B4003-007	\$25.00
	Distributor Cap Premium Grade, Made in the USA (Brass Contacts) Replaces: #IGC-1107S, 3-23	

*For 6-Volt Ignition Coils & Accessories, see p.44

Packard 8 Cylinder 1935-1936 with Autolite Distributor		
	B4003-037	\$36.50
	Cap Replaces: #IGP-1003, 3-26	
	B4004-027	\$7.75
	Rotor Replaces: #4-17	

*For 6-Volt Ignition Coils & Accessories, see p.44

Packard 8 Cylinder 1937 with Autolite Distributor		
	B4001-002	\$14.75
	Points Replaces: #IGW-3028S, 1-31	
B4002-002		\$4.75
	Condenser Replaces: #2-23, 2-31, 2-32, 2-34, 2-38, 2-42, IAT-2015L, IAT-2015R, IAT-3076AS, IAT-3076BS, IAT-3076D, IAT- 3076DS, IAT-3076L, IAT-3076LA, IAT- 3076R, IAT-3076RA, IBB-2015L, IBB- 2015R, IBB-2042-SS, IBB-2042SS-1, IBB- 2042-SS3, IG-2671F, IGH-3076, IGW-3139, 2098058, 3420600	

*For 6-Volt Ignition Coils & Accessories, see p.44

Packard 8 Cylinder 1935-1936 with Delco 662T Distributor	
	B4001-007 \$49.75 Points Dual Point set Consists of 1 set each, left & right hand Replaces: #1882022
	B4003-028 \$26.25 Cap Top Quality USA Made with Brass Contacts Replaces: #1911556, D-302
	B4004-018 \$5.75 Rotor Replaces: #1836893
	B4007-001 \$11.95 Cap Clip Short Mount, 1 Used Replaces: #1889967, 1847289, 453844, 453461
	B4007-002 \$11.95 Cap Clip Long Mount, 1 Used Replaces: #1889967, 1889999, 453844, 453461
	B4009-001 \$25.99 Distributor Bushing & Shim Kit

*For 6-Volt Ignition Coils & Accessories, see p.44

Packard 8 Cylinder 1937 with Delco Distributor	
	B4001-013 \$16.25 Points Replaces: #1938330 (D-103P), 1882024 (D103), 1871678, 1871870, 1918148
	B4002-001 \$4.75 Condenser Replaces: #1928111, D-203, 1869704, D-200
	B4003-028 \$26.25 Cap Top Quality USA Made with Brass Contacts Replaces: #1911556, D-302
	B4004-018 \$5.75 Rotor Replaces: #1836893

*For 6-Volt Ignition Coils & Accessories, see p.44

Packard 8 Cylinder 1938-1939	
	B4001-002 \$14.75 Points Replaces: #IGW-3028S, 1-31
	B4002-001 \$4.75 Condenser Replaces: #1928111, D-203, 1869704, D-200
	B4003-037 \$36.50 Cap Replaces: #IGP-1003, 3-26
	B4004-027 \$7.75 Rotor Replaces: #4-17





*For 6-Volt Ignition Coils & Accessories, see p.44

Packard 8 Cylinder 1940-1950 with IGT Distributor	
	B4001-022 \$16.75 Points Replaces: #IGS-2224, 1-44, 2084075
	B4002-002 \$4.75 Condenser Replaces: #2-23, 2-31, 2-32, 2-34, 2-38, 2-42, IAT-2015L, IAT-2015R, IAT-3076AS, IAT-3076BS, IAT-3076D, IAT-3076DS, IAT-3076L, IAT-3076LA, IAT-3076R, IAT-3076RA, IBB-2015L, IBB-2015R, IBB-2042-SS, IBB-2042SS-1, IBB-2042-SS3, IG-2671F, IGH-3076, IGW-3139, 2098058, 3420600
	B4003-037 \$36.50 Cap Replaces: #IGP-1003, 3-26
	B4004-027 \$7.75 Rotor Replaces: #4-17

*For 6-Volt Ignition Coils & Accessories, see p.44

Packard 8 Cylinder 1940-1950 with IGP Distributor, 1951-1954 with Autolite Distributor	
B4002-002	\$4.75
	Condenser Replaces: #2-23, 2-31, 2-32, 2-34, 2-38, 2-42, IAT-2015L, IAT-2015R, IAT-3076AS, IAT-3076BS, IAT-3076D, IAT-3076DS, IAT-3076L, IAT-3076LA, IAT-3076R, IAT-3076RA, IBB-2015L, IBB-2015R, IBB-2042-SS, IBB-2042SS-1, IBB-2042-SS3, IG-2671F, IGH-3076, IGW-3139, 2098058, 3420600
	B4003-037 Cap Replaces: #IGP-1003, 3-26
	B4004-027 Rotor Replaces: #4-17

*For 6-Volt Ignition Coils & Accessories, see p.44

Packard 8 Cylinder 1947-1952 with Delco Distributor	
	B4001-013 Points Replaces: #1938330 (D-103P), 1882024 (D103), 1871678, 1871870, 1918148
	B4002-001 Condenser Replaces: #1928111, D-203, 1869704, D-200
	B4003-028 Cap Top Quality USA Made with Brass Contacts Replaces: #1911556, D-302
	B4004-018 Rotor Replaces: #1836893
	B4007-001 Cap Clip Short Mount, 1 Used Replaces: #1889967, 1847289, 453844, 453461
	B4007-002 Cap Clip Long Mount, 1 Used Replaces: #1889967, 1889999, 453844, 453461

	B4009-001 Distributor Bushing & Shim Kit	\$25.99
--	---	----------------

*For 6-Volt Ignition Coils & Accessories, see p.44

Packard 8 Cylinder 1953-1958 with Delco Distributor		
	B4001-013 Points Replaces: #1938330 (D-103P), 1882024 (D103), 1871678, 1871870, 1918148	\$16.25
	B4002-001 Condenser Replaces: #1928111, D-203, 1869704, D-200	\$4.75
	B4003-031 Cap Replaces: #O-305	\$17.50
	B4004-019 Rotor Replaces: #1917249, D-403	\$10.50

*For 6- or 12-Volt Ignition Coils & Accessories, see p.44

Packard 8 Cylinder 1955-1956 with Autolite Distributor		
	B4001-034 Points Replaces: #IAZ-2040L, IAZ-2040LS (1-43), IGP-3028YS (1-18), IGW-3028HS (1-24, 1-42), IGW-3028NS, IGW-3028PS (1-30)	\$9.00
	B4002-002 Condenser Replaces: #2-23, 2-31, 2-32, 2-34, 2-38, 2-42, IAT-2015L, IAT-2015R, IAT-3076AS, IAT-3076BS, IAT-3076D, IAT-3076DS, IAT-3076L, IAT-3076LA, IAT-3076R, IAT-3076RA, IBB-2015L, IBB-2015R, IBB-2042-SS, IBB-2042SS-1, IBB-2042-SS3, IG-2671F, IGH-3076, IGW-3139, 2098058, 3420600	\$4.75
	B4003-038 Cap Replaces: #IAR-1003, 3-2	\$31.75
	B4004-027 Rotor Replaces: #4-17	\$7.75

ELECTRONIC IGNITION CONVERSION KITS

Replaces Points & Condenser



Packard 6 Cyl. 1937-1939 All
with Autolite IGS Series Distributor

B9600-307LS	12 Volt Negative Ground	\$169.45
B9600-307LSP6	6 Volt Positive Ground	\$185.95

Packard 6 Cyl. 1941-1947 with Delco Distributor

B9600-255LS	12 Volt Negative Ground	\$162.45
B9600-255LSP12	12 Volt Positive Ground	\$175.45
B9600-255LSP6	6 Volt Positive Ground	\$175.45

Packard 6 Cyl. 1940-1947
with Autolite Distributor #IGC-4279A

B9600-070A	12 Volt Negative Ground	\$195.95
B9600-070AP6	6 Volt Positive Ground	\$206.45

Packard 6 Cyl. 1941-1947
with Autolite Distributor #IGC-4505

B9600-072	12 Volt Negative Ground	\$242.95
B9600-072P6	6 Volt Positive Ground	\$264.95

Packard 8 Cyl. 1940-1950 with IGP Distributor

B9600-262A	12 Volt Negative Ground	\$177.45
B9600-262AP6	6 Volt Positive Ground	\$191.45

Packard 8 Cyl. 1940-1950 with IGT Distributor

B9600-228	12 Volt Negative Ground	\$198.45
B9600-228P6	6 Volt Positive Ground	\$216.45

Packard 8 Cyl. 1953-1958 with Delco Distributor

B9600-184	12 Volt Negative Ground	\$154.95
B9600-184P6	6 Volt Positive Ground	\$169.45
B9600-184N6	6 Volt Negative Ground	\$169.45



***For Ignition Coils &
Accessories, see p.44**

CUTOUT RELAYS & VOLTAGE REGULATORS

Note: Due to modern battery design, voltage regulators can't be used to charge low or dead batteries. Doing so will destroy the voltage regulator and void the warranty.

B8002-044 6-Volt Voltage Regulator \$149.75



Positive Ground, 37-41 Amp, Made in the U.S.A.

Replaces: **Delco** - #1118202, 1118212, 1118222, 1118226, 1118232, 1118238, 1118276, 1118278, 1118302, 1118314, 1118331, 1118351, 1118360, 1118366, 1118380, 1118382, 1118387, 1118392, 1118393, 1118726, 1118730, 1118731,

1118732, 1118743, 1118828, 1118829, 1118830, 1118834, 1118841, 1118842, 1118846, 1118850, 1118864, 1118865, 1118867, 1118950, 1119272, 5847, 5852, 5871, 5877, 5885, D602, D604, D607, D608, D610, D612

Fits: **Packard** 1941-1947, 6 cyl

B8002-028 6-Volt Autolite Type Voltage Regulator \$158.60



6 Volt, 3 Terminal, Flat Mounting Bracket Regulator (Premium Quality Made in the USA)

Replaces:

Prestolite - #8-117, 8-70, 8-74, GRX-761, VBE-6102A, VBE-6104A, VBO-4601F, VBO-4601K, VBO-4602B, VBO-4602R, VRB-4002C, VRP-

4001A, VRP-4001B, VRP-4002D, VRP-4003A, VRP-4003B, VRP-4004A, VRP-4004C, VRP-4004F, VRP-4008A, VRP-6001A, VRP-6001B, VRP-6002A, VRP-6005A, VRP-6101A, VRP-6101B

Fits: **Packard** - 1940 to 1950 With Autolite Generator

B8002-006 12-Volt Voltage Regulator \$67.50



12 Volt, 3 Terminal, Negative Ground, Voltage Regulator Premium Quality, Made in the USA
Fits: **Packard** - 1956-1958 All with Delco System

B8002-008 12-Volt Autolite Type Voltage Regulator \$69.75



12 Volt, 3 Terminal, Flat Mounting Premium Quality, Made in the USA
Replaces:

Prestolite - #8-154, 8-414, 8-58, 8-59, 8-722, 8-85, GRX-722, VBO-4201E, VBO-4202A, VBO-4202B, VBO-4202P, VBO-4202R, VR-6301A, VRX-6010, VRX-6010A

Chrysler - #1642333, 1842798, 1889944, 2095341, 2095531

Delco - #1972029, 1972061, A600, A600M, A605, A605M



Fits: **Packard** - 1956 8 Cyl. All w/ Autolite Generator

IDENTIFICATION TAGS

B9013-001	Small Autolite I.D. Tag (Blank)	\$7.00
	Small Autolite I.D. Tag (Stamped)	\$14.25
		2 5/16" Long, Black I.D. Tag for Distributors, Starters, & Generators with Rivets
B9013-002	Large Autolite I.D. Tag (Blank)	\$7.00
	Large Autolite I.D. Tag (Stamped)	\$14.25
		2 15/16" Long, Black I.D. Tag for Distributors, Starters, & Generators with Rivets

Delco Remy

B9013-003	Large Delco Remy I.D. Tag (Blank)	\$9.00
	Large Delco Remy I.D. Tag (Stamped)	\$16.25
		Large Black Delco-Remy I.D. Tag for Distributors, 6 Volt Starters, & 6 Volt Generators with Rivets, 1 1/4" X 2 7/8"
B9013-004	Delco Remy I.D. Tag (Blank)	\$7.00
	Delco Remy I.D. Tag (Stamped)	\$14.25
		Black Delco-Remy I.D. Tag for Distributors, 6 Volt Starters, & 6 Volt Generators with Rivets, 3/4" 2 5/16"

B9013-005	Red Delco Remy I.D. Tag (Blank)	\$7.00
	Red Delco Remy I.D. Tag (Stamped)	\$14.25
		Red Delco-Remy I.D. Tag for 12 Volt Starters & 12 Volt Generators with Rivets, 3/4" 2 5/16"
B9013-013	Delco Remy I.D. Tag (Blank)	\$7.00
	Delco Remy I.D. Tag (Stamped)	\$14.25
		Black Delco-Remy I.D. Tag for Distributors, 6 Volt Starters, & 6 Volt Generators with Rivets, 3/4" 2 5/16"

SWITCHES

B5010-018	Turn Signal Light Switch	\$73.50
		Universal Turn Signal Switch. Has right turn, left turn, and warning flasher modes. Metal Construction with Color Coded Wire Leads. Fuse, clamp ring, and instruction sheet included. Fits: Pre-1953 Vehicles

ALTERNATORS

B6001-001	12 Volt Alternator (1 Wire)	\$112.75
63 Amp, Low Cut In, Specially Built For Tractors, Forklifts, & Other Low Engine Speed Applications		
B6001-005	6 Volt Alternator (1 Wire, Positive Ground)	
6 Volt, 40 Amp Alternator with Positive Ground, 1 Wire, 3/8" pulley		

PIERCE ARROW

BATTERY CABLES

Pierce Arrow 1936-1938

B2000-006	Positive Ground Strap	\$13.50
------------------	-----------------------	----------------

TUNE UP PARTS

Pierce Arrow

1929-1936 8-Cylinder with Dual Points & Delco 660 Series Distributor

	B4001-007	\$49.75
	Points Dual Point set Consists of 1 set each, left & right hand Replaces: #1882022	
	B4002-001	\$4.75
	Condenser Replaces: #1928111, D-203, 1869704, D-200	
	B4003-028	\$26.25
	Cap (Not Original, but can be used as a Functional Replacement) Top Quality, USA Made with Brass Contacts Replaces: #1911556, D-302	
	B4004-018	\$5.75
	Rotor Replaces: #1836893	

Pierce Arrow



1935 8-Cylinder Model 845 (7 Passenger) with Delco Distributor #662J

	B4001-007	\$49.75
	Points Dual Point set Consists of 1 set each, left & right hand Replaces: #1882022	
	B4002-001	\$4.75
	Condenser Replaces: #1928111, D-203, 1869704, D-200	
	B4003-028	\$26.25
	Cap Top Quality USA Made with Brass Contacts Replaces: #1911556, D-302	

	B4004-018	\$5.75
	Rotor Replaces: #1836893	
	B4007-001	\$11.95
	Cap Clip Short Mount, 1 Used Replaces: #1889967, 1847289, 453844, 453461	
	B4007-002	\$11.95
	Cap Clip Long Mount, 1 Used Replaces: #1889967, 1889999, 453844, 453461	
	B4009-001	\$25.99
	Distributor Bushing & Shim Kit	

CUTOUT RELAYS & VOLTAGE REGULATORS

Note: Due to modern battery design, voltage regulators can't be used to charge low or dead batteries. Doing so will destroy the voltage regulator and void the warranty.

B8001-001	6-Volt Cutout Relay	\$19.50
	15 Amps, 6 Volt Works Positive or Negative Ground Replaces: Autolite - #CB4014, C4012(9-5), C4012(9-4), C4012(9-1), R40061 Delco - #266P, 266N, 265P, 265N, 5015850, 812970, 265J, 820845, 812971, 1116816, 265G, 265H, 1116755, 1116751, 1116809DR, 265B, 1842859, 265C, 1867781, 265F, 265D Fits: Pierce Arrow - 6 Cyl. 1929 (With Delco), 8 cyl 1929-1935, 12 Cyl. 1932, 12 Cyl. 1933-1936 (Most Models)	
B8001-002	Electronic Cutout Relay	\$19.50
	25 Amp, Works with 6, 12, or 24 Volts. & Positive or Negative Ground Replaces: Autolite - #CB4014, C4012(9-5), C4012(9-4), C4012(9-1), R40061 Delco - #266P, 266N, 265P, 265N, 5015850, 812970, 265J, 820845, 812971, 1116816, 265G, 265H, 1116755, 1116751, 1116809DR, 265B, 1842859, 265C, 1867781, 265F, 265D Fits: Pierce Arrow - 6 Cyl. 1929 (With Delco), 8 cyl 1929-1935, 12 Cyl. 1932, 12 Cyl. 1933-1936 (Most Models)	

PLYMOUTH

TABLE OF CONTENTS

Spark Plug Wire Sets _____	546
Battery Cables _____	546
Wire Harnesses _____	547
Tune Up Parts _____	547
Electronic Ignition Conversion Kit _____	551
Identification Tags _____	551
Cutout Relays & Voltage Regulators _____	552
Starter Switches & Solenoids, Alternators _____	552

SPARK PLUG WIRE SETS

Our Spark Plug Wire Sets Come Fully Assembled with the Proper Type Wire & Terminals.

They are Custom Tailored to Look & Fit Like Original Factory Equipment.

Varieties include:

Cotton Braid Wire: Copper Core with a Cotton Jacket.

PVC Wire: Copper Core with a Rubber Jacket.

EPDM Wire (E): Hi Performance Premium Conductor with a Tinned Copper Core, EPDM Silicone Insulation, and a Rubber Jacket.

Suppression Wire (S): for Electronic Ignition and is Spiral Wound, Low-Ohm, with EPDM Silicone Insulation and a Rubber Jacket.

Cotton Braid Suppression Wire (CS): also for Electronic Ignition, as Suppression Wire, but has an additional layer of Cotton Braid & Lacquer to replicate the vintage look, as well.



Plymouth 1929 Model U

4 Cyl. Tailored Spark Plug Wire Set

B1097-003	Original Type Cotton Braid Wire	\$44.50
B1097-003E	EPDM Wire	\$48.50
B1097-003S	Suppression Wire	\$48.50
B1097-003CS	Cotton Suppression Wire	\$76.50

Plymouth 1930 Model U & 1931-1932 Model PA, PB

4 Cyl. Tailored Spark Plug Wire Set

B1097-005	Original Type Cotton Braid Wire	\$44.50
B1097-005E	EPDM Wire	\$48.50
B1097-005S	Suppression Wire	\$48.50
B1097-005CS	Cotton Suppression Wire	\$76.50

Plymouth 1933-1934 Model PD, PE, & 1935-1936 Model PJ, P1, P2

6 Cyl. Tailored Spark Plug Wire Set

B1097-006	Original Type Cotton Braid Wire	\$50.75
B1097-006E	EPDM Wire	\$55.50
B1097-006S	Suppression Wire	\$55.50
B1097-006CS	Cotton Suppression Wire	\$87.50

Plymouth 1937

6 Cyl. Tailored Spark Plug Wire Set

B1097-010	Original Type Cotton Braid Wire	\$53.75
-----------	---------------------------------	---------

Plymouth 1937-1940 Model PT50, PT57, PT81, PT105 Truck

6 Cyl. Tailored Spark Plug Wire Set

B1097-007	Original Type EPDM Wire	\$55.50
-----------	-------------------------	---------

Plymouth 1939-1947

6 Cyl. Tailored Spark Plug Wire Set

B1097-001	Original Type Cotton Braid Wire	\$53.75
B1097-001E	EPDM Wire	\$58.75
B1097-001S	Suppression Wire	\$58.75
B1097-001CS	Cotton Suppression Wire	\$92.75

Plymouth 1948-1954

6 Cyl. Tailored Spark Plug Wire Set

B1097-008	Original Type Cotton Braid Wire	\$50.75
B1097-008E	EPDM Wire	\$55.50
B1097-008S	Suppression Wire	\$55.50
B1097-008CS	Cotton Suppression Wire	\$87.50

Plymouth 1955

8 Cyl. Tailored Spark Plug Wire Set

B1097-002	Original Type PVC Wire	\$68.00
B1097-002E	EPDM Wire	\$74.00
B1097-002S	Suppression Wire	\$74.00

Plymouth 1960s, Early 1970s

1960-1962 V8 w/Ram Air, 1964 w/361 cid, 383 cid, 426 cid engines (except hemi), 1965-1969 w/ 383 cid engines, 1970-1972 Fury & Wagon w/ 383 cid, 400cid, 440 cid eng

8 Cyl. Tailored Spark Plug Wire Set

B1097-004	Original Type PVC Wire	\$68.00
B1097-004E	EPDM Wire	\$74.00
B1097-004S	Suppression Wire	\$74.00

BATTERY CABLES



Our Battery Cables are made from the Proper Gauge Copper, as either Black Cotton Braided Wire or PVC Wire (whichever is correct for the application), using Soldered & Heat Sealed Brass or Copper Terminals.

Plymouth 1928-1931 (Early)

B2097-001	Positive Battery Cable	\$45.25
-----------	------------------------	---------

Plymouth 1931 (Late)

B2097-002	Positive Battery Cable	\$46.75
-----------	------------------------	---------

Plymouth 1932

B2097-031	Positive Battery Cable	\$52.50
B2097-032	Negative Battery Cable	\$89.25

Plymouth 1933-1934

B2097-003	Positive Battery Cable	\$45.25
------------------	------------------------	----------------

Plymouth 1938

B2097-033	Switch to Starter Cable	\$38.50
------------------	-------------------------	----------------

Plymouth 1939

B2097-004	Positive Battery Cable	\$46.75
------------------	------------------------	----------------

Plymouth 1940

B2097-005	Positive Battery Cable	\$41.50
B2097-006	Negative Battery Cable	\$73.50

Plymouth 1941

B2097-007	Positive Battery Cable	\$41.50
B2097-008	Negative Battery Cable	\$47.75

Plymouth 1942

B2097-009	Positive Battery Cable	\$41.50
B2097-010	Negative Battery Cable	\$44.00

Plymouth 1946-1948

B2097-011	Positive Battery Cable	\$41.50
B2097-012	Negative Battery Cable	\$34.00
B2097-013	Switch to Starter Cable	\$29.50

Plymouth 1949

B2097-014	Positive Battery Cable	\$30.75
B2097-016	Negative Battery Cable	\$30.75
B2097-013	Switch to Starter Cable	\$29.75

Plymouth 1950-1951

B2097-017	Positive Battery Cable	\$30.75
B2097-018	Negative Battery Cable	\$31.25
B2097-019	Switch to Starter Cable	\$32.00

Plymouth 1952

B2097-020	Positive Battery Cable	\$30.75
B2097-021	Negative Battery Cable	\$31.25
B2097-022	Switch to Starter Cable	\$29.50

Plymouth 1953-1954

B2097-023	Positive Battery Cable	\$37.00
B2097-024	Negative Battery Cable	\$31.25
B2097-025	Switch to Starter Cable	\$29.50

Plymouth 6 Cyl. 1955

B2097-026	Positive Battery Cable	\$37.00
B2097-027	Negative Battery Cable	\$31.25
B2097-028	Switch to Starter Cable	\$32.00

Plymouth 8 Cyl. 1955

B2097-029	Positive Battery Cable	\$37.00
B2097-030	Negative Battery Cable	\$31.25



WIRING HARNESSSES

Our Wire Harnesses are made with our **premium cotton braid and/or PVC wire**.

They have the **correct gauge, color, wire, & fuse holders** (if needed).

All terminals are **soldered according to the original**.

(Harnesses do not include Battery Cables & Spark Plug Wires; however, we can supply these as separate products.)

NO HIDDEN COSTS, NOTHING EXTRA TO BUY!

Plymouth 1938 Model P6 Coupe

B3097-003	Complete Wire Harness	\$844.50
------------------	-----------------------	-----------------

Plymouth 1941 Model P11, P12 Station Wagon

B3097-002	Complete Wire Harness	\$816.75
------------------	-----------------------	-----------------

TUNE UP PARTS

Plymouth 4 Cylinder 1928-1932, Model Q, U, PA, PB with Delco Distributor # 629A, 629H, 629M, 629R, 629T, 630B, 635T, 635W



B4001-021 **\$13.75**

Points

Replaces: #1855520, D-109



B4002-001 **\$4.75**

Condenser

Replaces: #1928111, D-203, 1869704, D-200



B4004-021 **\$14.75**

Rotor

Replaces: #816774

	B4003-033	\$25.50
	Cap Replaces: #811589, 1835536, 821589, 818425	

*For 6-Volt Ignition Coils & Accessories, see p.44

Plymouth 4 Cylinder 1980-1985 w/ 1.7, 2.2 Ltr.

	B4003-072	\$16.00
	Cap Replaces: #5206918, 5213034	

Plymouth 6 Cylinder 1928-1932
1933-1934 with 622H Distributor-

	B4001-021	\$13.75
	Points Replaces: #1855520, D-109	

	B4002-001	\$4.75
	Condenser Replaces: #1928111, D-203, 1869704, D-200	

	B4004-021	\$14.75
	Rotor Replaces: #816774	

	B4003-059	\$22.50
	Cap Replaces: #816779, 822465, 1831800, 1853240	

*For 6-Volt Ignition Coils & Accessories, see p.44

Plymouth 6 Cylinder 1933-1934 with 644W Distributor

	B4100-001	\$10.50
	PCR Kit Includes: Points (#B4001-001), Condenser (#B4002-001), Rotor (#B4004-002) Replaces: Points - #D100HP, 1855720 Condenser - #1928111, D-203, 1869704, D-200 Rotor - #820445, D400	

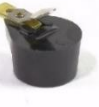
	B4004-002	\$5.75
	Rotor Replaces: #820445, D400	

	B4003-002	\$20.25
	Distributor Cap Premium Grade, Made in the USA (Brass Contacts) Replaces: #824735, D301	

	B4007-001	\$11.95
	Cap Clip Short Mount, 1 Used Replaces: #1889967, 1847289, 453844, 453461	

	B4007-002	\$11.95
	Cap Clip Long Mount, 1 Used Replaces: #1889967, 1889999, 453844, 453461	

	B4008-001	\$14.99
	Distributor Insulator Replaces: #1904376	

	B4009-001	\$25.99
	Distributor Bushing & Shim Kit	

B4006-001	Dust Cover	Replaces: #1900119	\$9.99
------------------	-------------------	--------------------	---------------

*For 6- or 12-Volt Ignition Coils & Accessories, see p.44

Plymouth 6-Cylinder 1935-1938

	B4001-002	\$14.75
	Points Replaces: #IGW-3028S, 1-31	

	B4002-006	\$7.50
	Condenser #2-31, 2-38, 2-42, 2-95, IAT-1125S, IAT-3076BS, IBB-2042SS-1, IBB-2042-SS3, IG-3927F, IG-3927G, IG-3927K, IG-3927R	

	B4004-007	\$8.25
	Rotor Premium Grade, Made in the USA Replaces: #4-19	

	B4003-007	\$25.00
	Distributor Cap Premium Grade, Made in the USA (Brass Contacts) Replaces: #IGC-1107S, 3-23	

*For 6-Volt Ignition Coils & Accessories, see p.44

Plymouth 6-Cylinder 1939, 1949, 1950
(with IGS Distributor)

	B4001-005	\$9.75
	Points Replaces: #1-4, 1-8, 1-9, 1-20, 1-22, 1-45, IAD-3128S, IGP-3028ES, IGP3028FS, IGS2224L, IGW3028AS	

	B4002-006	\$7.50
	Condenser #2-31, 2-38, 2-42, 2-95, IAT-1125S, IAT-3076BS, IBB-2042SS-1, IBB-2042-SS3, IG-3927F, IG-3927G, IG-3927K, IG-3927R	

	B4004-007	\$8.25
	Rotor Premium Grade, Made in the USA Replaces: #4-19	

	B4003-007	\$25.00
	Distributor Cap Premium Grade, Made in the USA (Brass Contacts) Replaces: #IGC-1107S, 3-23	

*For 6-Volt Ignition Coils & Accessories, see p.44

Plymouth 6 Cylinder 1950 (with IAP Distributor)

	B4001-005	\$9.75
	Points Replaces: #1-4, 1-8, 1-9, 1-20, 1-22, 1-45, IAD-3128S, IGP-3028ES, IGP3028FS, IGS2224L, IGW3028AS	

B4002-002	\$4.75
------------------	---------------

	Condenser	
	Replaces: #2-23, 2-31, 2-32, 2-34, 2-38, 2-42, IAT-2015L, IAT-2015R, IAT-3076AS, IAT-3076BS, IAT-3076D, IAT-3076DS, IAT-3076L, IAT-3076LA, IAT-3076R, IAT-3076RA, IBB-2015L, IBB-2015R, IBB-2042-SS, IBB-2042SS-1, IBB-2042-SS3, IG-2671F, IGH-3076, IGW-3139, 2098058, 3420600	

	B4003-035	\$31.50
	Cap Replaces: #IAO-1003, 3-1	

	B4004-007	\$8.25
	Rotor Premium Grade, Made in the USA Replaces: #4-19	

*For 6-Volt Ignition Coils & Accessories, see p.44

Plymouth 6 Cylinder 1946-1950 (with IAT Distributor)

	B4001-022	\$16.75
	Points Replaces: #IGS-2224, 1-44, 2084075	

	B4002-006	\$7.50
	Condenser #2-31, 2-38, 2-42, 2-95, IAT-1125S, IAT-3076BS, IBB-2042SS-1, IBB-2042-SS3, IG-3927F, IG-3927G, IG-3927K, IG-3927R	

	B4003-036	\$13.50
	Cap Replaces: #IAT-1033, IAT-1033A, IAT-1033C, 3-4, 3-34, 3-37	

	B4004-025	\$6.75
	Rotor Replaces: #IAT-1016	

*For 6-Volt Ignition Coils & Accessories, see p.44

Plymouth 6 Cylinder 1951-1955

	B4001-022	\$16.75
	Points Replaces: #IGS-2224, 1-44, 2084075	

B4002-002	\$4.75
------------------	---------------

	Condenser	
	Replaces: #2-23, 2-31, 2-32, 2-34, 2-38, 2-42, IAT-2015L, IAT-2015R, IAT-3076AS, IAT-3076BS, IAT-3076D, IAT-3076DS, IAT-3076L, IAT-3076LA, IAT-3076R, IAT-3076RA, IBB-2015L, IBB-2015R, IBB-2042-SS, IBB-2042SS-1, IBB-2042-SS3, IG-2671F, IGH-3076, IGW-3139, 2098058, 3420600	

	B4003-036	\$13.50
	Cap Replaces: #IAT-1033, IAT-1033A, IAT-1033C, 3-4, 3-34, 3-37	

	B4004-026	\$6.75
	Rotor Replaces: #IAU-1016A, 4-4	

*For 6-Volt Ignition Coils & Accessories, see p.44

Plymouth 6 Cylinder 1956-1959

	B4001-022	\$16.75
	Points Replaces: #IGS-2224, 1-44, 2084075	

B4002-002	\$4.75
------------------	---------------

	Condenser	
	Replaces: #2-23, 2-31, 2-32, 2-34, 2-38, 2-42, IAT-2015L, IAT-2015R, IAT-3076AS, IAT-3076BS, IAT-3076D, IAT-3076DS, IAT-3076L, IAT-3076LA, IAT-3076R, IAT-3076RA, IBB-2015L, IBB-2015R, IBB-2042-SS, IBB-2042SS-1, IBB-2042-SS3, IG-2671F, IGH-3076, IGW-3139, 2098058, 3420600	

	B4003-036	\$13.50
	Cap Replaces: #IAT-1033, IAT-1033A, IAT-1033C, 3-4, 3-34, 3-37	

	B4004-026	\$6.75
	Rotor Replaces: #IAU-1016A, 4-4	

*For 12-Volt Ignition Coils & Accessories, see p.44

Plymouth 6 Cylinder 1960-1966 Canada Models (with Autolite Distributor IBR-4201)	
	B4001-022 \$16.75 Points Replaces: #IGS-2224, 1-44, 2084075
	B4002-006 \$7.50 Condenser #2-31, 2-38, 2-42, 2-95, IAT-1125S, IAT-3076BS, IBB-2042SS-1, IBB-2042-SS3, IG-3927F, IG-3927G, IG-3927K, IG-3927R
	B4003-070 \$10.75 Cap Replaces: #IBR-1003B, 3-109
	B4004-045 \$9.75 Rotor Replaces: #IBR-1016, 4-25

*For 12-Volt Ignition Coils & Accessories, see p.44

Plymouth 8 Cylinder 1955	
	B4001-023 \$19.75 Points *2 Required- Each Sold Separately* Replaces: #IAZ-2040RS, 1-19, 1-26, 1-41, IAZ-2040RS, IGP-3028ZS, IGW-3028KS
	B4002-002 \$4.75 Condenser Replaces: #2-23, 2-31, 2-32, 2-34, 2-38, 2-42, IAT-2015L, IAT-2015R, IAT-3076AS, IAT-3076BS, IAT-3076D, IAT-3076DS, IAT-3076L, IAT-3076LA, IAT-3076R, IAT-3076RA, IBB-2015L, IBB-2015R, IBB-2042-SS, IBB-2042SS-1, IBB-2042-SS3, IG-2671F, IGH-3076, IGW-3139, 2098058, 3420600
	B4003-038 \$31.75 Cap Replaces: #IAR-1003, 3-2
	B4004-027 \$7.75 Rotor Replaces: #4-17

*For 6-Volt Ignition Coils & Accessories, see p.44

Plymouth 8 Cylinder 1956	
	B4002-002 \$4.75 Condenser Replaces: #2-23, 2-31, 2-32, 2-34, 2-38, 2-42, IAT-2015L, IAT-2015R, IAT-3076AS, IAT-3076BS, IAT-3076D, IAT-3076DS, IAT-3076L, IAT-3076LA, IAT-3076R, IAT-3076RA, IBB-2015L, IBB-2015R, IBB-2042-SS, IBB-2042SS-1, IBB-2042-SS3, IG-2671F, IG-3927F, IG-3927G, IG-3927K, IG-3927R, IGH-3076, IGW-3139, 2098058, 3420600
	B4003-039 \$18.75 Cap Replaces: #IBN-1003, 3-8, 3-35
	B4004-028 \$6.25 Rotor Replaces: #1658535, 41059, 3926326, 980892, R103003, IBK1016, 4-7

*For 12-Volt Ignition Coils & Accessories, see p.44

Plymouth 8 Cylinder 1957 (<i>Fury</i>)	
	B4001-023 \$19.75 Points *2 Required- Each Sold Separately* Replaces: #IAZ-2040RS, 1-19, 1-26, 1-41, IAZ-2040RS, IGP-3028ZS, IGW-3028KS
	B4002-002 \$4.75 Condenser Replaces: #2-23, 2-31, 2-32, 2-34, 2-38, 2-42, IAT-2015L, IAT-2015R, IAT-3076AS, IAT-3076BS, IAT-3076D, IAT-3076DS, IAT-3076L, IAT-3076LA, IAT-3076R, IAT-3076RA, IBB-2015L, IBB-2015R, IBB-2042-SS, IBB-2042SS-1, IBB-2042-SS3, IG-2671F, IGH-3076, IGW-3139, 2098058, 3420600
	B4003-039 \$18.75 Cap Replaces: #IBN-1003, 3-8, 3-35
	B4004-028 \$6.25 Rotor Replaces: #1658535, 41059, 3926326, 980892, R103003, IBK1016, 4-7

*For 12-Volt Ignition Coils & Accessories, see p.44

Plymouth 8 Cylinder 1957 (All Except Fury), 1958 (All Except Distributor #IBS-4003, 06B)	
	B4001-008 \$4.75 Points Replaces: #IBP-2040R, IBP-3028AS, 1-32, 1-46

B4002-002		\$4.75
 <p>Condenser Replaces: #2-23, 2-31, 2-32, 2-34, 2-38, 2-42, IAT-2015L, IAT-2015R, IAT-3076AS, IAT-3076BS, IAT-3076D, IAT-3076DS, IAT-3076L, IAT-3076LA, IAT-3076R, IAT-3076RA, IBB-2015L, IBB-2015R, IBB-2042-SS, IBB-2042SS-1, IBB-2042-SS3, IG-2671F, IGH-3076, IGW-3139, 2098058, 3420600</p>		
 <p>B4003-039</p> <p>Cap Replaces: #IBN-1003, 3-8, 3-35</p>		\$18.75
 <p>B4004-028</p> <p>Rotor Replaces: #1658535, 41059, 3926326, 980892, R103003, IBK1016, 4-7</p>		\$6.25

*For 12-Volt Ignition Coils & Accessories, see p.44

Plymouth 6 Cylinder 1980-1983, 225, 3.7L Eng.		
 <p>B4003-071</p> <p>Cap Replaces: #4176030</p>		\$10.50
 <p>B4004-029</p> <p>Rotor Replaces: #4-1C, 4-16, 297981, 1394885, 1838516, 2098770, 2716867, 3874401, 4106104, 12309507, 312769607, C401, C401Z, C403, C411, CH308, CH310, CH312, CH317, CH403, DRC303, DRC329, XA921</p>		\$5.75

ELECTRONIC IGNITION CONVERSION KITS

Replaces Points & Condenser



Plymouth 4 Cyl. 1928-1929 with Delco 630B, 625T Distributors & 1930-1932 Model PA, PB, U with Delco 629A, 629H, 629M		
B9600-311	12 Volt Negative Ground	\$154.95
B9600-311P6	6 Volt Positive Ground	\$165.45
Plymouth 6 Cyl. 1928-1932, 1933-1934 with 622H Distributor		
B9600-309	12 Volt Negative Ground	\$154.95
B9600-309P6	6 Volt Positive Ground	\$169.45

Plymouth 6 Cyl. 1933-1934 with 644W Distributor		
B9600-255LS	12 Volt Negative Ground	\$162.45
B9600-255LSP12	12 Volt Positive Ground	\$175.45
B9600-255LSP6	6 Volt Positive Ground	\$175.45

Plymouth 6 Cyl. 1935-1942 All with Autolite IGS Series Distributor & 1946-1950 All with Autolite IGS, IAP Series Distributor		
B9600-307LS	12 Volt Negative Ground	\$169.45
B9600-307LSP6	6 Volt Positive Ground	\$185.95

Plymouth 6 Cyl. 1960-1972 All		
B9600-040A	12 Volt Negative Ground	\$134.45

Plymouth 8 Cyl. 1959-1972 All with Single Point Distributor		
B9600-042A	12 Volt Negative Ground	\$118.95

Plymouth 8 Cyl. 1959-1971 with Dual Point Distributor (Except 340 Six Pack)		
B9600-043	12 Volt Negative Ground	\$92.99

Plymouth 8 Cyl. 1968-1973 340 Six Pack		
B9600-044	12 Volt Negative Ground	\$139.95



*For Ignition Coils & Accessories, see p.44

IDENTIFICATION TAGS

B9013-003	Large Delco Remy I.D. Tag (Blank)	\$9.00
	Large Delco Remy I.D. Tag (Stamped)	\$16.25

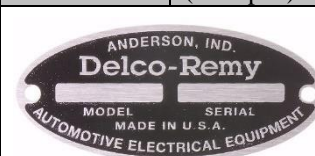



Large Black Delco-Remy I.D. Tag for Distributors, 6 Volt Starters, & 6 Volt Generators with Rivets, 1 1/4" X 2 7/8"

B9013-004	Delco Remy I.D. Tag (Blank)	\$7.00
	Delco Remy I.D. Tag (Stamped)	\$14.25



Black Delco-Remy I.D. Tag for Distributors, 6 Volt Starters, & 6 Volt Generators with Rivets, 3/4" 2 5/16"

B9013-005	Red Delco Remy I.D. Tag (Blank)	\$7.00
	Red Delco Remy I.D. Tag (Stamped)	\$14.25
		Red Delco-Remy I.D. Tag for 12 Volt Starters & 12 Volt Generators with Rivets, 3/4" 2 5/16"
B9013-013	Delco Remy I.D. Tag (Blank)	\$7.00
	Delco Remy I.D. Tag (Stamped)	\$14.25
		Black Delco-Remy I.D. Tag for Distributors, 6 Volt Starters, & 6 Volt Generators with Rivets, 3/4" 2 5/16"

B8002-031	6-Volt Autolite Type Voltage Regulator	\$144.88
		6 Volt, 3 Terminal, Flat Mounting Bracket Regulator. Positive Ground. (Premium Quality Made in the USA) Replaces: Chrysler - #1311467, 1343753, 1502074, 1641510 Delco - #A602, A602M Prestolite - #8-76, 8-762, VBE-6001A, VBE-6101, VBE-6201A, VBO-4602E, VBO-4602V Fits: Plymouth - 6 Cyl. 1951-1955 (All with GGW Series Generator), 8 Cyl. 1955 (All with GGW Series Generator)

B8002-008	12-Volt Autolite Type Voltage Regulator	\$69.75
		12 Volt, 3 Terminal, Flat Mounting (Premium Quality, Made in the USA) Replaces: Prestolite - #8-154, 8-414, 8-58, 8-59, 8-722, 8-85, GRX-722, VBO-4201E, VBO-4202A, VBO-4202B, VBO-4202P, VBO-4202R, VR-6301A, VRX-6010, VRX-6010 ^a Chrysler - #1642333, 1842798, 1889944, 2095341, 2095531 Delco - #1972029, 1972061, A600, A600M, A605, A605M Fits: Plymouth - 1956 to 1960 (Except GGA Generator)

CUTOUT RELAYS & VOLTAGE REGULATORS

Note: Due to modern battery design, voltage regulators can't be used to charge low or dead batteries. Doing so will destroy the voltage regulator and void the warranty.

B8001-001	6-Volt Cutout Relay	\$19.50
		15 Amps, 6 Volt, Pos. or Neg. Ground Replaces: Autolite - #CB4014, C4012(9-5), C4012(9-4), C4012(9-1), R40061 Delco - #266P, 266N, 265P, 265N, 5015850, 812970, 265J, 820845, 812971, 1116816, 265G, 265H, 1116755, 1116751, 1116809DR, 265B, 1842859, 265C, 1867781, 265F, 265D Fits: Plymouth - 1933-1938 & 1939 P7

B8001-002	Electronic Cutout Relay	\$19.50
		25 Amp, Works with 6, 12, or 24 Volts. & Positive or Negative Ground Replaces: Autolite - #CB4014, C4012(9-5), C4012(9-4), C4012(9-1), R40061 Delco - #266P, 266N, 265P, 265N, 5015850, 812970, 265J, 820845, 812971, 1116816, 265G, 265H, 1116755, 1116751, 1116809DR, 265B, 1842859, 265C, 1867781, 265F, 265D Fits: Plymouth - 1933-1938 & 1939 P7

B8002-028	6-Volt Autolite Type Voltage Regulator	\$158.60
		6 Volt, 3 Terminal, Flat Mounting Bracket Regulator (Premium Quality Made in the USA) Replaces: Prestolite - #8-117, 8-70, 8-74, GRX-761, VBE-6102A, VBE-6104A, VBO-4601F, VBO-4601K, VBO-4602B, VBO-4602R, VRB-4002C, VRP-4001A, VRP-4001B, VRP-4002D, VRP-4003A, VRP-4003B, VRP-4004A, VRP-4004C, VRP-4004F, VRP-4008A, VRP-6001A, VRP-6001B, VRP-6002A, VRP-6005A, VRP-6101A, VRP-6101B Chrysler - #1120515, 1121978, 1257394, 1321757, 1343573, 1571161, 2095209, 871763 Fits: Plymouth - 1939 to 1949 (All Except GGA Generator, & 1939 P7)

SWITCHES & SOLENOIDS

B5006-001	Starter Switch (Long Shaft)	\$12.75
		6 or 12 Volt Panel Mounted Manual Push Replaces: Delco - #192119, D900, 450C Prestolite - #15-121, 15-122, 15-409, 15-45, 15-47, 15-50, 15-51, SW-2916, SW-4001, SW-4002, SW-4005, SW-4010, SW-4013, SW-4015, SW-4017, SW-4101, SWX-47 Fits: Plymouth - 1930-1934

B5010-018	Turn Signal Light Switch	\$73.50
		Right turn, left turn, and warning flasher modes. Metal Construction with Color Coded Wire Leads. Fuse, clamp ring, and instruction sheet included. Fits: Pre-1953 Vehicles

B5007-007	6 Volt Internal Ground Solenoid	\$17.50
		Has a Flat Bracket & 3 Terminal Post. Works with 6 Volt Systems. Replaces: Autolite - #SST-4006 (15-29), SST-4007 (15-30) Fits: Plymouth - 1946-1954 (All), 1955 (All with Std. Transmission)

ALTERNATORS

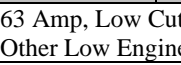
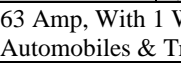
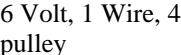
B6001-001	12 Volt Alternator (1 Wire)	\$112.75
		63 Amp, Low Cut In, Specially Built For Tractors, Forklifts, & Other Low Engine Speed Applications
B6001-002	12 Volt Alternator (1 Wire/ 3 Wire)	\$118.75
		63 Amp, With 1 Wire Or 3 Wire For Warning Lamp On Automobiles & Trucks
B6001-005	6 Volt Alternator	\$166.50
		6 Volt, 1 Wire, 40 Amp Alternator with Positive Ground, 3/8" pulley

PONTIAC

TABLE OF CONTENTS

Spark Plug Wire Sets _____	553
Battery Cables _____	554
Wire Harnesses _____	554
Tune Up Parts _____	554
Electronic Ignition Conversion Kits _____	557
Identification Tags _____	558
Cutout Relays & Voltage Regulators _____	558
Switches , Flashers, Alternators _____	559

SPARK PLUG WIRE SETS

Our Spark Plug Wire Sets Come Fully Assembled with the Proper Type Wire & Terminals.

They are Custom Tailored to Look & Fit Like Original Factory Equipment.

Varieties include:

Cotton Braid Wire: Copper Core with a Cotton Jacket.

Packard 440 Wire (P): Tinned Copper Core with EPDM Silicone Insulation.

Suppression Wire (S): for Electronic Ignition and is Spiral Wound, Low-Ohm, with EPDM Silicone Insulation and a Rubber Jacket.

Cotton Braid Suppression Wire (CS): also for Electronic Ignition, as Suppression Wire, but has an additional layer of Cotton Braid & Lacquer to replicate the vintage look, as well..



Pontiac 1927-1931

6 Cyl. Tailored Spark Plug Wire Set

B1098-001	Original Type Cotton Braid Wire	\$62.50
B1098-001P	Packard 440 Wire	\$178.00
B1098-001S	Suppression Wire	\$68.25
B1098-001CS	Cotton Suppression Wire	\$108.00

Pontiac 1935-1936 Silver Streak

6 Cyl. Tailored Spark Plug Wire Set

B1098-009	Original Type Cotton Braid Wire	\$50.75
B1098-009P	Packard 440 Wire	\$144.50

Pontiac 1937-1947

6 Cyl. Tailored Spark Plug Wire Set

B1098-002	Original Type Cotton Braid Wire	\$38.00
B1098-002P	Packard 440 Wire	\$107.75
B1098-002E	EPDM Wire	\$41.50
B1098-002S	Suppression Wire	\$41.50
B1098-002CS	Cotton Suppression Wire	\$65.75

Pontiac 1948-1954

6 Cyl. Tailored Spark Plug Wire Set

B1098-006	Original Type Packard 440 Wire	\$120.00
B1098-006E	EPDM Wire	\$46.00
B1098-006S	Suppression Wire	\$46.00

Pontiac 1931-1932

8 Cyl. Tailored Spark Plug Wire Set with Original Distributor Cap

B1098-003	Original Type Cotton Braid Wire	\$69.50
B1098-003E	EPDM Wire	\$76.00
B1098-003P	Packard 440 Wire	\$197.00

with Modern Distributor Cap

B1098-012	Original Type Cotton Braid Wire	\$80.50
B1098-012E	EPDM Wire	\$87.75
B1098-012P	Packard 440 Wire	\$219.00

Pontiac 1933-1936

8 Cyl. Tailored Spark Plug Wire Set

B1098-010	Original Type Cotton Braid Wire	\$66.50
B1098-010P	Packard 440 Wire	\$192.50
B1098-010E	EPDM Wire	\$72.50
B1098-010S	Suppression Wire	\$72.50
B1098-010CS	Cotton Suppression Wire	\$114.75

Pontiac 1937-1940

8 Cyl. Tailored Spark Plug Wire Set

B1098-011	Original Type Cotton Braid Wire	\$68.00
B1098-011E	EPDM Wire	\$74.25
B1098-011S	Suppression Wire	\$74.25
B1098-011P	Packard 440 Wire	\$192.50

Pontiac 1941-1947

8 Cyl. Tailored Spark Plug Wire Set

B1098-004	Original Type Cotton Braid Wire	\$71.00
B1098-004E	EPDM Wire	\$77.50
B1098-004S	Suppression Wire	\$77.50
B1098-004P	Packard 440 Wire	\$201.50

Pontiac 1948-1954

8 Cyl. Tailored Spark Plug Wire Set

B1098-007	Original Type Packard 440 Wire	\$151.50
B1098-007E	EPDM Wire	\$58.25
B1098-007S	Suppression Wire	\$58.25

Pontiac 1955

8 Cyl. Tailored Spark Plug Wire Set

B1098-005	Original Type Packard 440 Wire	\$193.50
B1098-005E	EPDM Wire	\$72.50
B1098-005S	Suppression Wire	\$72.50

Pontiac 1957

8 Cyl. Tailored Spark Plug Wire Set

B1098-008	Original Type Packard 440 Wire	\$201.50
B1098-008E	EPDM Wire	\$77.50
B1098-008S	Suppression Wire	\$77.50

BATTERY CABLES



Our Battery Cables are made from the Proper Gauge Copper, as either Black Cotton Braided Wire or PVC Wire (whichever is correct for the application), using Soldered & Heat Sealed Brass or Copper Terminals.

Pontiac 6 Cyl. 1926-1932

B2098-001	Positive Battery Cable	\$39.50
B2000-002	Negative Ground Strap	\$9.50
B2098-002	Switch to Starter Cable	\$24.75

Pontiac 8 Cyl. 1930, 1932-1933

B2098-006	Positive Battery Cable	\$40.25
B2000-005	Negative Ground Strap	\$12.50

Pontiac 8 Cyl. 1934

B2098-007	Positive Battery Cable	\$40.25
B2000-006	Negative Ground Strap	\$13.50

Pontiac 1935-1937 All

B2098-008	Positive Battery Cable	\$40.25
B2000-006	Negative Ground Strap	\$13.50

Pontiac 1938-1948 All

B2098-011	Positive Battery Cable	\$30.25
B2000-007	Negative Ground Strap	\$14.50

Pontiac 6 Cyl. 1949-1951

B2098-012	Positive Battery Cable	\$39.00
B2000-007	Negative Ground Strap	\$14.50

TUNE UP PARTS

Pontiac 6 Cylinder 1928-1932

	B4001-021	\$13.75
	Points Replaces: #1855520, D-109	
	B4002-001	\$4.75
	Condenser Replaces: #1928111, D-203, 1869704, D-200	
	B4004-021	\$14.75
	Rotor Replaces: #816774	

Pontiac 6 Cyl. 1952-1954

B2098-013	Positive Battery Cable	\$36.75
B2000-007	Negative Ground Strap	\$14.50

Pontiac 8 Cyl. 1949-1954

B2098-014	Positive Battery Cable	\$35.50
B2000-007	Negative Ground Strap	\$14.50

Pontiac All 1955

B2098-017	Positive Battery Cable	\$42.75
B2000-011	Negative Ground Strap 2 Pc Assembly	\$16.50

Pontiac All 1956-1957

B2098-015	Positive Battery Cable	\$38.50
B2000-011	Negative Ground Strap (2 Piece Assembly)	\$16.50

Pontiac All 1958

B2098-019	Positive Battery Cable	\$42.25
B2098-018	Negative Battery Cable	\$33.50



WIRING HARNESSES

Pontiac 1927

B3098-001	Complete Wire Harness	\$674.75
------------------	-----------------------	-----------------



Pontiac 1931 & 1932 with V8

B3098-002	Complete Wire Harness	\$706.50
------------------	-----------------------	-----------------

	B4003-059	\$22.50
	Cap Replaces: #816779, 822465, 1831800, 1853240	

*For 6-Volt Ignition Coils & Accessories, see p.44

Pontiac 6 Cylinder 1935-1936

	B4001-006	\$11.75
	Points Replaces: #1882022	
	B4002-001	\$4.75
	Condenser Replaces: #1928111, D-203, 1869704, D-200	

	B4003-002	\$20.25
Distributor Cap Premium Grade, Made in the USA (Brass Contacts) Replaces: #824735, D301		
	B4004-002	\$5.75
Rotor Replaces: #820445, D400		
	B4007-001	\$11.95
Cap Clip Short Mount, 1 Used Replaces: #1889967, 1847289, 453844, 453461		
	B4007-002	\$11.95
Cap Clip Long Mount, 1 Used Replaces: #1889967, 1889999, 453844, 453461		
	B4009-001	\$25.99
Distributor Bushing & Shim Kit		
B4006-001	Dust Cover	Replaces: #1900119 \$9.99

*For 6-Volt Ignition Coils & Accessories, see p.44

	B4009-001	\$25.99
Distributor Bushing & Shim Kit		
B4006-001	Dust Cover	Replaces: #1900119 \$9.99

*For 6-Volt Ignition Coils & Accessories, see p.44

Pontiac 6 Cylinder 1954

	B4001-013	\$16.25
Points Replaces: #1938330 (D-103P), 1882024 (D103), 1871678, 1871870, 1918148		
	B4002-001	\$4.75
Condenser Replaces: #1928111, D-203, 1869704, D-200		
	B4003-034	\$18.25
Cap Replaces: #268574C92		
	B4004-022	\$6.50
Rotor Replaces: #1924245, D-405		

*For 6-Volt Ignition Coils & Accessories, see p.44

Pontiac 6 Cylinder 1937-1953



	B4001-013	\$16.25
Points Replaces: #1938330 (D-103P), 1882024 (D103), 1871678, 1871870, 1918148		
	B4002-001	\$4.75
Condenser Replaces: #1928111, D-203, 1869704, D-200		
	B4003-002	\$20.25
Distributor Cap Premium Grade, Made in the USA (Brass Contacts) Replaces: #824735, D301		
	B4004-002	\$5.75
Rotor Replaces: #820445, D400		
	B4007-001	\$11.95
Cap Clip Short Mount, 1 Used Replaces: #1889967, 1847289, 453844, 453461		
	B4007-002	\$11.95
Cap Clip Long Mount, 1 Used Replaces: #1889967, 1889999, 453844, 453461		

Pontiac 6 Cylinder 1964-1969

	B4001-030	\$4.75
Points Replaces: #1954557, D-108P		
	B4002-012	\$4.75
Condenser Replaces: #D205		
	B4004-013	\$4.75
Rotor Premium Grade, Made in the USA Replaces: #D-419R, 1963972		
	B4003-021	\$8.75
Distributor Cap Replaces: #1954569, D-316		
B4006-004	Dust Cover	Replaces: #1960325 \$16.99

Pontiac 8 Cylinder 1932-1936		
	B4001-006	\$11.75
	Points Replaces: #1882022	
	B4002-001	\$4.75
	Condenser Replaces: #1928111, D-203, 1869704, D-200	
	B4003-028	\$26.25
	Cap Top Quality USA Made with Brass Contacts Replaces: #1911556, D-302	
	B4004-018	\$5.75
	Rotor Replaces: #1836893	
	B4007-001	\$11.95
	Cap Clip Short Mount, 1 Used Replaces: #1889967, 1847289, 453844, 453461	
	B4007-002	\$11.95
	Cap Clip Long Mount, 1 Used Replaces: #1889967, 1889999, 453844, 453461	
	B4009-001	\$25.99
	Distributor Bushing & Shim Kit	

*For 6-Volt Ignition Coils & Accessories, see p.44

Pontiac 8 Cylinder 1937-1939		
	B4001-013	\$16.25
	Points Replaces: #1938330 (D-103P), 1882024 (D103), 1871678, 1871870, 1918148	
	B4002-001	\$4.75
	Condenser Replaces: #1928111, D-203, 1869704, D-200	
	B4003-028	\$26.25
	Cap Top Quality USA Made with Brass Contacts Replaces: #1911556, D-302	

	B4004-018	\$5.75
	Rotor Replaces: #1836893	
	B4007-001	\$11.95
	Cap Clip Short Mount, 1 Used Replaces: #1889967, 1847289, 453844, 453461	
	B4007-002	\$11.95
	Cap Clip Long Mount, 1 Used Replaces: #1889967, 1889999, 453844, 453461	
	B4009-001	\$24.99
	Distributor Bushing & Shim Kit	



*For 6-Volt Ignition Coils & Accessories, see p.44



Pontiac 8 Cylinder 1940-1954		
	B4001-013	\$16.25
	Points Replaces: #1938330 (D-103P), 1882024 (D103), 1871678, 1871870, 1918148	
	B4002-001	\$4.75
	Condenser Replaces: #1928111, D-203, 1869704, D-200	
	B4003-028	\$26.25
	Cap Top Quality USA Made with Brass Contacts Replaces: #1911556, D-302	
	B4004-018	\$5.75
	Rotor Replaces: #1836893	
	B4007-001	\$11.95
	Cap Clip Short Mount, 1 Used Replaces: #1889967, 1847289, 453844, 453461	
	B4007-002	\$11.95
	Cap Clip Long Mount, 1 Used Replaces: #1889967, 1889999, 453844, 453461	
	B4009-001	\$25.99
	Distributor Bushing & Shim Kit	

*For 6-Volt Ignition Coils & Accessories, see p.44

Pontiac 8 Cylinder 1955-1956		
	B4001-013	\$16.25
	Points Replaces: #1938330 (D-103P), 1882024 (D103), 1871678, 1871870, 1918148	
	B4002-001	\$4.75
	Condenser Replaces: #1928111, D-203, 1869704, D-200	
	B4003-031	\$17.50
	Cap Replaces: #O-305	
	B4004-023	\$4.75
	Rotor Replaces: #1927393, D-407	

Pontiac 8 Cylinder 1957 with Dual Points		
	B4001-013	\$16.25
	Points Replaces: #1938330 (D-103P), 1882024 (D103), 1871678, 1871870, 1918148	
	B4002-001	\$4.75
	Condenser Replaces: #1928111, D-203, 1869704, D-200	
	B4003-031	\$17.50
	Cap Replaces: #O-305	
	B4004-019	\$10.50
	Rotor Replaces: #1917249, D-403	

Pontiac 8 Cylinder 1957 with Single Points, 1958-1974		
	B4001-019	\$6.75
	Points Replaces: #D-106PS	
	B4002-016	\$4.75
	Condenser Replaces: #1932004, D-204	

	B4003-032	\$14.25
	Cap Premium Quality, Brass Contacts Replaces: #1942654, D309	
	B4004-020	\$4.50
	Rotor Replaces: #1852722, 1932015, D-426R	

ELECTRONIC IGNITION **CONVERSION KITS**

Replaces Points & Condenser



Pontiac 4 Cyl. 1962-1963 All		
B9600-008A	12 Volt Negative Ground	\$134.45

Pontiac 6 Cyl. 1928-1932		
B9600-309	12 Volt Negative Ground	\$154.95
B9600-309P6	6 Volt Positive Ground	\$169.45

Pontiac 6 Cyl. 1934-1956		
B9600-184	12 Volt Negative Ground	\$154.95

Pontiac 6 Cyl. 1964-1974		
B9600-013A	12 Volt Negative Ground	\$124.95

Pontiac 8 Cyl. 1956-1958 (Lobe Sensor Version)		
B9600-259LS	12 Volt Negative Ground	\$132.95

Pontiac 8 Cyl. 1956-1958 (All with Dual Point Distributor & Mechanical Advance Under Breaker Plate)		
B9600-184	12 Volt Negative Ground	\$154.95

Pontiac 8 Cyl. 1957-1974 (Lobe Sensor Version)		
B9600-021LS	12 Volt Negative Ground	\$132.95
B9600-021LSII	12 Volt Negative Ground with Upgraded Current Protection	\$175.95

Pontiac 8 Cyl. 1957-1974 All		
B9600-021	12 Volt Negative Ground	\$117.95





***For Ignition Coils & Accessories, see p.44**

IDENTIFICATION TAGS

B9013-003	Large Delco Remy I.D. Tag (Blank)	\$9.00
	Large Delco Remy I.D. Tag (Stamped)	\$16.25
		Large Black Delco-Remy I.D. Tag for Distributors, 6 Volt Starters, & 6 Volt Generators with Rivets, 1 1/4" X 2 7/8"
B9013-004	Delco Remy I.D. Tag (Blank)	\$7.00
	Delco Remy I.D. Tag (Stamped)	\$14.25
		Black Delco-Remy I.D. Tag for Distributors, 6 Volt Starters, & 6 Volt Generators with Rivets, 3/4" 2 5/16"
B9013-005	Red Delco Remy I.D. Tag (Blank)	\$7.00
	Red Delco Remy I.D. Tag (Stamped)	\$14.25
		Red Delco-Remy I.D. Tag for 12 Volt Starters & 12 Volt Generators with Rivets, 3/4" 2 5/16"
B9013-013	Delco Remy I.D. Tag (Blank)	\$7.00
	Delco Remy I.D. Tag (Stamped)	\$14.25
		Black Delco-Remy I.D. Tag for Distributors, 6 Volt Starters, & 6 Volt Generators with Rivets, 3/4" 2 5/16"

CUTOUT RELAYS & VOLTAGE REGULATORS

Note: Due to modern battery design, voltage regulators can't be used to charge low or dead batteries. Doing so will destroy the voltage regulator and void the warranty.

B8001-001	6-Volt Cutout Relay	\$19.50
		15 Amps, Positive or Negative Ground Replaces: Autolite - #CB4014, C4012(9-5), C4012(9-4), C4012(9-1), R40061 Delco - #266P, 266N, 265P, 265N, 5015850, 812970, 265J, 820845, 812971, 1116816, 265G, 265H, 1116755, 1116751, 1116809DR, 265B, 1842859, 265C, 1867781, 265F, 265D
Fits: Pontiac - 1928 - 1939		
B8001-002	Electronic Cutout Relay	\$19.50
		25 Amp, Works with 6, 12, or 24 Volts. & Positive or Negative Ground Replaces: Autolite - #CB4014, C4012(9-5), C4012(9-4), C4012(9-1), R40061 Delco - #266P, 266N, 265P, 265N, 5015850, 812970, 265J, 820845, 812971, 1116816, 265G, 265H, 1116755, 1116751, 1116809DR, 265B, 1842859, 265C, 1867781, 265F, 265D
Fits: Pontiac - 1928 - 1939		

6-Volt Saddle Mounted Cutout Relay (Delco Version)		
B8001-004	Premium Quality, Made in the USA	\$122.50
B8001-006	Standard Quality	\$38.59
		Cutout Relay, 25 Amp, 6 Volt, Works Positive or Negative Ground. Replaces: Delco - #266P, 266N, 265P, 265N, 5015850, 812970, 265J, 820845, 812971, 1116816, 265G, 265H, 1116755, 1116751, 1116809DR, 265B, 1842859, 265C, 1867781, 265F, 265D
Fits: Pontiac - 1928 - 1939		

6-Volt Delco Type Voltage Regulator		
B8002-001	Premium Quality, Made in the USA	\$87.75
B8002-042	Standard Quality	\$34.75
		6-Volt, 3-Terminal, 32-42 Amps, Negative Ground, Flat Mounting Bracket, A-Circuit Replaces: Delco - 1118201, 1118300, 1118301, 1118357, 1118364, 1118721, 1118843, 1118847, 1118869, 1118872, D601, D614, D653 Fits: Pontiac - 1940-1950

B8002-004	6-Volt Voltage Regulator	\$142.75
		6 Volt, 3 Terminal, Negative Ground, Voltage Regulator Replaces Delco #1118201, 1118207, 1118211, 1118216, 1118221, 1118233, 1118237, 1118242, 1118272, 1118301, 1118311, 1118313, 1118343, 1118349, 1118361, 1118720, 1118847, 1118866, 1118869, 1118872, 1118921, 5547, 5587, 5599, 5809, 5819, 5854, 5872, 5873, 5875, 5878, D601, D614, D653 Fits: Pontiac - 1951-1954 all
PREMIUM QUALITY/ USA MADE		

B8002-006	12-Volt Voltage Regulator	\$67.50
		12 Volt, 3 Terminal, Negative Ground, Voltage Regulator Fits: Pontiac - 1954-1958 All, 1959-1962 with Standard Generator Premium Quality/ USA Made

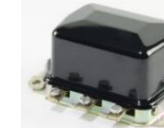

B8002-007	12-Volt Voltage Regulator	\$125.50
		12 Volt, 3 Terminal, Negative Ground, Voltage Regulator Fits: Pontiac - 1959-1962 With Heavy Duty Generator or With Air Conditioning Premium Quality/ USA Made

B8002-030	12-Volt Alternator Voltage Regulator	\$14.50
		Heavy Duty, 12 Volt, Negative Ground Alternator Voltage Regulator. Has 4 spade terminals (field, 2, 3, 4). Designed for 'B' type circuits in negative ground system, 12 volt systems, Delco 10DN/ 20DN Replaces: Delco - #D630, D635, D663, 1119513, 1119515, 1119508, 1119519, D663, 1119502, 1119516, 1119506, 1119512, 1119515 Fits: Pontiac - 6, 8 Cyl. 1963-1964, 6, 8 Cyl. 1965-1968, 6, 8 Cyl. 1969, 6, 8 Cyl. 1970-1972 (excluding Firebird)

SWITCHES & FLASHERS

B5002-011	3-Position, 6-Volt Headlight Switch	\$57.75
	30 Amps, 6 Volt, 3 Position Headlight Switch. Has Four Screw Terminals. Two Stud Terminals. 5.5 Ohm Rheostat for Panel Lights & Circuit Braker. Includes Metal Knob, Shaft and Nut. Replaces: Delco - #1994016, 1994022, 1995031, 1995035, 1995041, 1995045, 1995048, D-1502, D1504 Fits: Pontiac - 1942-1952	
B5010-018	Turn Signal Light Switch	\$73.50
	Has right turn, left turn, and warning flasher modes. Metal Construction with Color Coded Wire Leads. Fuse, clamp ring, and instruction sheet included. Fits: Pre-1953 Vehicles	
B5007-042	6-Volt Delco Starter Solenoid Switch	\$52.75
	Replaces: Delco - #1114307, 1114310, 1114312, 1114410, 1118135, 1118140, 1118148, D936, D938, D939, D949, D964 Prestolite - #15-228, SWX-228, SWX-429 Fits: Pontiac - 6 Cyl. 1949-1953, 8 Cyl. 1949-1953	
B9017-040	6-Volt Thermal Flasher	\$9.75
	6-Volt Thermal Flasher, Three Terminal Replaces: #535 Pontiac Fits: 1946-54	

ALTERNATORS

B6001-001	12 Volt Alternator (1 Wire)	\$112.75	
63 Amp, Low Cut In, Built For Tractors, Forklifts, & Other Low Speed Applications			
B6001-002	12 Volt Alternator (1 Wire/ 3 Wire)	\$118.75	
63 Amp, With 1 Wire Or 3 Wire For Warning Lamp On Automobiles & Trucks			
B6001-006	12 Volt Alternator (1 Wire, Negative Ground)	\$166.50	
6 Volt, 40 Amp Alternator with Negative Ground, 1 Wire			

REO CAR & TRUCK SPARK PLUG WIRE SETS

REO 1926 Model T6 Car

6 Cyl. Tailored Spark Plug Wire Set

B1111-001	Original Type Cotton Braid Wire	\$70.50
------------------	--	----------------

REO 1925-1933 Speed Wagon (Truck)

6 Cyl. Tailored Spark Plug Wire Set

B1099-001	Original Type Cotton Braid Wire	\$70.50
------------------	--	----------------





WIRING HARNESSES

REO 1949 Model D19

B3099-001	Complete Wire Harness	\$611.75
------------------	------------------------------	-----------------

SWITCHES & SOLENOIDS

B5010-018	Turn Signal Light Switch	\$73.50
	Right turn, left turn, and warning flasher modes. Metal Construction with Color Coded Wire Leads. Fuse, clamp ring, and instruction sheet included. Fits: Pre-1953 Vehicles	
B5007-042	6-Volt Delco Starter Solenoid Switch	\$52.75
	Replaces: Delco - #1114307, 1114310, 1114312, 1114410, 1118135, 1118140, 1118148, D936, D938, D939, D949, D964 Prestolite - #15-228, SWX-228, SWX-429 Fits: Reo Truck - 6 Cyl. 1952-1956	

CUTOUT RELAYS & VOLTAGE REGULATORS

Note: Due to modern battery design, voltage regulators can't be used to charge low or dead batteries. Doing so will destroy the voltage regulator and void the warranty.

B8001-001	6-Volt Cutout Relay	\$19.50
	15 Amps, 6 Volt Works Positive or Negative Ground Replaces: Autolite - #CB4014, C4012(9-5), C4012(9-4), C4012(9-1), R40061 Delco - #266P, 266N, 265P, 265N, 5015850, 812970, 265J, 820845, 812971, 1116816, 265G, 265H, 1116755, 1116751, 1116809DR, 265B, 1842859, 265C, 1867781, 265F, 265D Fits: Reo - 1932-1936	

B8001-002	Electronic Cutout Relay	\$19.50
 <p>25 Amp, Works with 6, 12, or 24 Volts. & Positive or Negative Ground Replaces: Autolite - #CB4014, C4012(9-5), C4012(9-4), C4012(9-1), R40061 Delco - #266P, 266N, 265P, 265N, 5015850, 812970, 265J, 820845, 812971, 1116816, 265G, 265H, 1116755, 1116751, 1116809DR, 265B, 1842859, 265C, 1867781, 265F, 265D Fits: Reo - 1932-1936</p>		

6-Volt Saddle Mounted Cutout Relay (Delco Version)		
B8001-004	Premium Quality, Made in the USA	\$122.50
B8001-006	Standard Quality	\$38.59
 <p>Cutout Relay, 25 Amp, 6 Volt, Works Positive or Negative Ground. Replaces: Delco - #266P, 266N, 265P, 265N, 5015850, 812970, 265J, 820845, 812971, 1116816, 265G, 265H, 1116755, 1116751, 1116809DR, 265B, 1842859, 265C, 1867781, 265F, 265D Fits: Reo - 1932-1936</p>		

ELECTRONIC IGNITION CONVERSION KITS

Replaces Points & Condenser

Reo Truck 4 Cyl. 1930-1932 with Delco 629J Distributor		
B9600-311	12 Volt Negative Ground	\$154.95
B9600-311P6	6 Volt Positive Ground	\$165.45

ROCKNE BATTERY CABLES

 <p>Our Battery Cables are made from the Proper Gauge Copper, as either Black Cotton Braided Wire or PVC Wire (whichever is correct for the application), using Soldered & Heat Sealed Brass or Copper Terminals.</p>
--

Rockne 1932-1965		
B2100-001	Negative Battery Cable	\$32.00
Rockne 1932-1975		
B2100-002	Negative Battery Cable	\$32.00

ROLLS ROYCE

SPARK PLUG WIRE SETS

<p>Our Spark Plug Wire Sets Come Fully Assembled with the Proper Type Wire & Terminals.</p> <p>They are Custom Tailored to Look & Fit Like Original Factory Equipment.</p> <p>Varieties include:</p> <p>PVC Wire: Copper Core with a Rubber Jacket.</p> <p>EPDM Wire (E): Hi Performance Premium Conductor with a Tinned Copper Core, EPDM Silicone Insulation, and a Rubber Jacket.</p>	
---	---



Rolls Royce 1950 Cloud I

6 Cyl. Tailored Spark Plug Wire Set		
B1101-001	Original Type PVC Wire	\$55.50
B1101-001E	EPDM Wire	\$66.75

TUNE UP PARTS

Rolls Royce 6 Cylinder 1920's with American Bosch Distributor Type T666		
	B4001-004 Points	\$45.00

Rolls Royce 6 Cylinder Mark VI R Type, Cloud 1 with Delco Distributor 7952214N8 & others		
	B4001-006 Points Replaces: #1882022	\$11.75
	B4002-001 Condenser Replaces: #1928111, D-203, 1869704, D-200	\$4.75
	B4004-002 Rotor Replaces: #820445, D400	\$5.75

Rolls Royce 8 Cylinder 1960's (Delco distributor)		
	B4003-028 Cap Top Quality USA Made with Brass Contacts Replaces: #1911556, D-302	\$26.25
	B4004-018 Rotor Replaces: #1836893	\$5.75

ELECTRONIC IGNITION CONVERSION KITS

Replaces Points & Condenser



Rolls Royce Springfield Ghost

(Needs Conversion Cup Sold by RROC)

B9600-DU6	12 Volt Negative Ground	\$118.25
------------------	-------------------------	-----------------

Rolls Royce 6 Cyl.

All with Delco Distributor PO-6

B9600-178	12 Volt Negative Ground	\$191.45
------------------	-------------------------	-----------------

B9600-178P12	12 Volt Positive Ground	\$206.45
---------------------	-------------------------	-----------------



***For Ignition Coils &
Accessories, see p.44**

IDENTIFICATION TAGS

B9013-004	Delco Remy I.D. Tag (Blank)	\$7.00
	Delco Remy I.D. Tag (Stamped)	\$14.25



Black Delco-Remy I.D. Tag for Distributors, 6 Volt Starters, & 6 Volt Generators with Rivets, 3/4" 2 5/16"

B9013-005	Red Delco Remy I.D. Tag (Blank)	\$7.00
	Red Delco Remy I.D. Tag (Stamped)	\$14.25

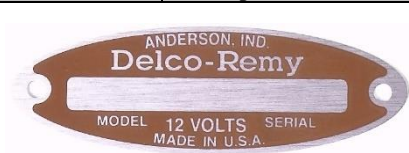

Red Delco-Remy I.D. Tag for 12 Volt Starters & 12 Volt Generators with Rivets, 3/4" 2 5/16"

B9013-013	Delco Remy I.D. Tag (Blank)	\$7.00
	Delco Remy I.D. Tag (Stamped)	\$14.25

Black Delco-Remy I.D. Tag for Distributors, 6 Volt Starters, & 6 Volt Generators with Rivets, 3/4" 2 5/16"

LIGHT SWITCHES

B5010-018	Turn Signal Light Switch	\$73.50
------------------	---------------------------------	----------------

Universal Turn Signal Switch. Has right turn, left turn, and warning flasher modes. Metal Construction with Color Coded Wire Leads. Fuse, clamp ring, and instruction sheet included.
Fits: Pre-1953 Vehicles

ALTERNATORS

B6001-001	12 Volt Alternator (1 Wire)	\$112.75
------------------	------------------------------------	-----------------

63 Amp, Low Cut In, Specially Built For Tractors, Forklifts, & Other Low Engine Speed Applications

SCRIPPS-BOOTH

BATTERY CABLES

Our Battery Cables are made from the Proper Gauge Copper, as either Black Cotton Braided Wire or PVC Wire (whichever is correct for the application), using Soldered & Heat Sealed Brass or Copper Terminals.

Scripps-Booth 1919

B2000-009	Negative Ground Strap	\$17.00
B2101-001	Negative Battery Cable	\$106.25

STUDEBAKER

TABLE OF CONTENTS

Spark Plug Wire Sets _____	562
Battery Cables _____	562
Tune Up Parts _____	563
Electronic Ignition Conversion Kits _____	564
Identification Tags _____	564
Cutout Relays & Voltage Regulators _____	564
Alternators _____	565
Switches _____	565

SPARK PLUG WIRE SETS

Our Spark Plug Wire Sets Come Fully Assembled with the Proper Type Wire & Terminals, Custom Tailored to Look & Fit Like Original Factory Equipment.



Varieties include:

Cotton Braid Wire: Copper Core with a Cotton Jacket.

PVC Wire: Copper Core with a Rubber Jacket.

EPDM Wire (E): Hi Performance Premium Conductor with a Tinned Copper Core, EPDM Silicone Insulation, and a Rubber Jacket.

Suppression Wire (S): for Electronic Ignition and is Spiral Wound, Low-Ohm, with EPDM Silicone Insulation and a Rubber Jacket.

Cotton Braid Suppression Wire (CS): also for Electronic Ignition, as Suppression Wire, but has an additional layer of Cotton Braid & Lacquer to replicate the vintage look, as well.

Studebaker 1920-1924 Light 6

6 Cyl. Tailored Spark Plug Wire Set

B1103-001	Original Type Cotton Braid Wire	\$50.75
B1103-001E	EPDM Wire	\$55.50

Studebaker 1922 Big 6

6 Cyl. Tailored Spark Plug Wire Set

B1103-007	Original Type Cotton Braid Wire	\$53.75
B1103-007E	EPDM Wire	\$58.75

Studebaker 1923

6 Cyl. Tailored Spark Plug Wire Set

B1103-002	Original Type Cotton Braid Wire	\$50.75
B1103-002E	EPDM Wire	\$55.50

Studebaker 1926 Standard Six

6 Cyl. Tailored Spark Plug Wire Set

B1103-006	Original Type Cotton Braid Wire	\$50.75
B1103-006E	EPDM Wire	\$55.50

Studebaker 1940-1955

6 Cyl. Tailored Spark Plug Wire Set

B1103-003	Original Type Cotton Braid Wire	\$50.75
B1103-003E	EPDM Wire	\$55.50
B1103-003S	Suppression Wire	\$55.50
B1103-003CS	Cotton Suppression Wire	\$87.50

8-Cylinder Car

Studebaker 1940-1942

8 Cyl. Tailored Spark Plug Wire Set

B1103-004	Original Type Cotton Braid Wire	\$68.00
B1103-004E	EPDM Wire	\$74.00

Studebaker 1945-1955

8 Cyl. Tailored Spark Plug Wire Set

B1103-005	Original Type PVC Wire	\$61.75
B1103-005E	EPDM Wire	\$74.00
B1103-005S	Suppression Wire	\$74.00

Truck

Studebaker Truck 1949 Model R2

6 Cyl. Tailored Spark Plug Wire Set

B1104-001	Original Type Cotton Braid Wire	\$50.75
B1104-001E	EPDM Wire	\$55.50

Studebaker Truck 1957-1959

6 Cyl. Tailored Spark Plug Wire Set

B1104-002	Original Type Cotton Braid Wire	\$50.75
B1104-002E	EPDM Wire	\$55.50

BATTERY CABLES



Our Battery Cables are made from the Proper Gauge Copper, as either Black Cotton Braided Wire or PVC Wire (whichever is correct for the application), using Soldered & Heat Sealed Brass or Copper Terminals.

Studebaker 6 Cyl. 1931-1934

B2000-004	Positive Ground Strap	\$10.50
B2103-001	Negative Battery Cable	\$33.75
B2103-007	Switch to Starter Cable	\$23.00

Studebaker 1931 – 1934, 1991, 1992

B2000-004	Positive Ground Strap	\$10.50
-----------	-----------------------	---------

Studebaker 6 Cyl. 1934-1936

B2000-004	Positive Ground Strap	\$10.50
-----------	-----------------------	---------

Studebaker 8 Cyl. 1934-1936

Commander, Dictator, & President

B2000-006	Positive Ground Strap	\$13.50
-----------	-----------------------	---------

Studebaker 6 Cyl. Dictator 1935-1936

B2000-006	Positive Ground Strap	\$13.50
-----------	-----------------------	---------

Studebaker 6 & 8 Cyl. 1937-1939

B2000-002	Positive Ground Strap	\$9.50
-----------	-----------------------	--------

Studebaker 6 Cyl. Champion 1940

B2000-002	Positive Ground Strap	\$9.50
B2103-002	Negative Battery Cable	\$32.25

Studebaker 6 Cyl. Champion 1941-1942

B2000-002	Positive Ground Strap	\$9.50
B2103-003	Negative Battery Cable	\$30.75

Studebaker 6 Cyl. Champion 1946

B2000-007	Positive Ground Strap	\$14.50
B2103-004	Negative Battery Cable	\$45.25

Studebaker 6 Cyl. Champion 1947-1949

B2000-007	Positive Ground Strap	\$14.50
B2103-005	Negative Battery Cable	\$42.25

Studebaker 6 Cyl. Champion 1950-1951

B2000-007	Positive Ground Strap	\$14.50
------------------	-----------------------	----------------

Studebaker 1950-1951

B2103-006	Negative Battery Cable	\$36.75
------------------	------------------------	----------------

Studebaker 6 Cyl. Champion 1952

B2000-005	Positive Ground Strap	\$12.50
B2103-029	Negative Battery Cable	\$36.75

Studebaker 6 Cyl. 1953 Champion & 5 Passenger Coupe

B2103-008	Positive Battery Cable	\$39.00
B2103-009	Negative Battery Cable	\$36.75

Studebaker 6 Cyl. 1953 4 Door Champion

B2000-007	Positive Ground Strap	\$14.50
B2103-010	Negative Battery Cable	\$39.00

Studebaker 6 Cyl. 1954-1955 Champion Hard Top & 5 Passenger Coupe

B2000-009	Positive Ground Strap	\$17.00
B2103-011	Negative Battery Cable	\$36.75

Studebaker 6 Cyl. 1954-1955 4 Door Champion & 4 Door Station Wagon

B2000-007	Positive Ground Strap	\$14.50
B2103-012	Negative Battery Cable	\$36.75

Studebaker 6 Cyl. Commander 1940

B2000-002	Positive Ground Strap	\$9.50
B2103-013	Negative Battery Cable	\$30.00

Studebaker 6 Cyl. Commander 1941-1942

B2000-002	Positive Ground Strap	\$9.50
B2103-014	Negative Battery Cable	\$36.75

Studebaker 8 Cyl. 1940

B2000-002	Positive Ground Strap	\$9.50
B2103-015	Negative Battery Cable	\$32.25

Studebaker 8 Cyl. 1941-1942

B2000-002	Positive Ground Strap	\$9.50
B2103-016	Negative Battery Cable	\$39.00

Studebaker 8 Cyl. 1951

B2000-005	Positive Ground Strap	\$12.50
B2103-017	Negative Battery Cable	\$36.75
B2103-018	Switch to Starter Cable	\$27.75

Studebaker 8 Cyl. 1952

B2000-005	Positive Ground Strap	\$12.50
B2103-019	Negative Battery Cable	\$33.00
B2103-020	Switch to Starter Cable	\$29.75

Studebaker 8 Cyl. 1953

B2000-006	Positive Ground Strap	\$13.50
B2103-021	Negative Battery Cable	\$28.25
B2103-022	Switch to Starter Cable	\$34.25

Studebaker 8 Cyl. 1953-1954 Commander Hard Top & 5 Passenger Coupe

B2000-009	Positive Ground Strap	\$17.00
B2103-024	Negative Battery Cable	\$33.00
B2103-025	Switch to Starter Cable	\$26.50

Studebaker 8 Cyl. 1954 L & 4 Door Station Wagon

B2000-006	Positive Ground Strap	\$13.50
B2103-023	Negative Battery Cable	\$28.25

Studebaker 8 Cyl. 1955 4 Door Sedan

B2000-006	Positive Ground Strap	\$13.50
B2103-026	Negative Battery Cable	\$28.25

Studebaker 8 Cyl. 1956 President

B2000-006	Positive Ground Strap	\$13.50
B2103-027	Negative Battery Cable	\$28.25
B2103-028	Switch to Starter Cable	\$29.75

TUNE UP PARTS

Studebaker 8 Cyl 1950-1958 with Delco Distributor #1110822

	B4001-013	\$16.25
	Points Replaces: #1938330 (D-103P), 1882024 (D103), 1871678, 1871870, 1918148	
	B4002-001	\$4.75
	Condenser Replaces: #1928111, D-203, 1869704, D-200	
	B4003-031	\$17.50
	Cap Replaces: #O-305	

	B4004-019	\$10.50
	Rotor Replaces: #1917249, D-403	

*For 6-Volt Ignition Coils & Accessories, see p.44.

ELECTRONIC IGNITION CONVERSION KITS

Replaces Points & Condenser



Studebaker Car 6 Cyl. 1942-1950 with Autolite Distributor # IGC-4729A		
B9600-070A	12 Volt Negative Ground	\$195.95
B9600-070AP6	6 Volt Positive Ground	\$206.45

Studebaker Car 6 Cyl. with Autolite Distributor # IAT-4010		
B9600-072	12 Volt Negative Ground	\$242.95
B9600-072P6	6 Volt Positive Ground	\$264.95

Studebaker 8 Cyl 1950-1958 with Delco Distributor #1110822		
B9600-184	12 Volt Negative Ground	\$154.95
B9600-184P6	6 Volt Positive Ground	\$169.45

IDENTIFICATION TAGS

Delco Remy

	B9013-003	Large Delco Remy I.D. Tag (Blank)	\$9.00
		Large Delco Remy I.D. Tag (Stamped)	\$16.25
		Large Black Delco-Remy I.D. Tag for Distributors, 6 Volt Starters, & 6 Volt Generators with Rivets, 1 1/4" X 2 7/8"	
	B9013-004	Delco Remy I.D. Tag (Blank)	\$7.00
		Delco Remy I.D. Tag (Stamped)	\$14.25
		Black Delco-Remy I.D. Tag for Distributors, 6 Volt Starters, & 6 Volt Generators with Rivets, 3/4" 2 5/16"	

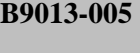
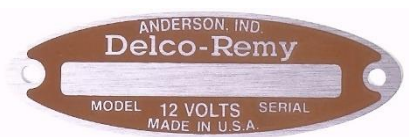
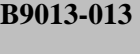
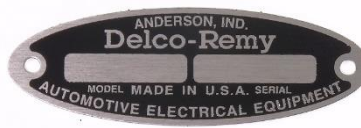
	B9013-005	Red Delco Remy I.D. Tag (Blank)	\$7.00
		Red Delco Remy I.D. Tag (Stamped)	\$14.25
		Red Delco-Remy I.D. Tag for 12 Volt Starters & 12 Volt Generators with Rivets, 3/4" 2 5/16"	
	B9013-013	Delco Remy I.D. Tag (Blank)	\$7.00
		Delco Remy I.D. Tag (Stamped)	\$14.25
		Black Delco-Remy I.D. Tag for Distributors, 6 Volt Starters, & 6 Volt Generators with Rivets, 3/4" 2 5/16"	

CUTOUT RELAYS & VOLTAGE REGULATORS

Note: Due to modern battery design, voltage regulators can't be used to charge low or dead batteries. Doing so will destroy the voltage regulator and void the warranty.



	B8001-001	6-Volt Cutout Relay	\$19.50
15 Amps, Positive or Negative Ground Replaces: Autolite - CB4014, C4012(9-5), C4012(9-4), C4012(9-1), R40061 Delco - #266P, 266N, 265P, 265N, 5015850, 812970, 265J, 820845, 812971, 1116816, 265G, 265H, 1116755, 1116751, 1116809DR, 265B, 1842859, 265C, 1867781, 265F, 265D Fits: Studebaker - 1928 - 1935			
	B8001-002	Electronic Cutout Relay	\$19.50
25 Amp, Works with 6, 12, or 24 Volts. & Positive or Negative Ground Replaces: Autolite - #CB4014, C4012(9-5), C4012(9-4), C4012(9-1), R40061 Delco - #266P, 266N, 265P, 265N, 5015850, 812970, 265J, 820845, 812971, 1116816, 265G, 265H, 1116755, 1116751, 1116809DR, 265B, 1842859, 265C, 1867781, 265F, 265D Fits: Studebaker - 1928 - 1935			
	B8002-028	6-Volt Autolite Type Voltage Regulator	\$158.60
3 Terminal, Flat Mounting Bracket Regulator (Premium Quality/ Made in the USA) Replaces: Prestolite - #8-117, 8-70, 8-74, GRX-761, VBE-6102A, VBE-6104A, VBO-4601F, VBO-4601K, VBO-4602B, VBO-4602R, VRB-4002C, VRP-4001A, VRP-4001B, VRP-4002D, VRP-4003A, VRP-4003B, VRP-4004A, VRP-4004C, VRP-4004F, VRP-4008A, VRP-6001A, VRP-6001B, VRP-6002A, VRP-6005A, VRP-6101A, VRP-6101B Chrysler - #1120515, 1121978, 1257394, 1321757, 1343573, 1571161, 2095209, 871763 Fits: Studebaker - 1937 to 1950 With Autolite Generator			

B8002-044	6-Volt Voltage Regulator	\$149.75
	<p>Positive Ground, 37-41 Amp, Made in the U.S.A. Replaces: Delco - #1118202, 1118212, 1118222, 1118226, 1118232, 1118238, 1118276, 1118278, 1118302, 1118314, 1118331, 1118351, 1118360, 1118366, 1118380, 1118382, 1118387, 1118392, 1118393, 1118726, 1118730, 1118731, 1118732, 1118743, 1118828, 1118829, 1118830, 1118834, 1118841, 1118842, 1118846, 1118850, 1118864, 1118865, 1118867, 1118950, 1119272, 5847, 5852, 5871, 5877, 5885, D602, D604, D607, D608, D610, D612 Fits: Studebaker 1940-1950, 6 & 8 cyl</p>	
B8002-031	6-Volt Autolite Type Voltage Regulator	\$144.88
	<p>6 Volt, 3 Terminal, Flat Mounting Bracket Regulator. Positive Ground. (Premium Quality/ Made in the USA) Replaces: Chrysler - #1311467, 1343753, 1502074, 1641510 Delco - #A602, A602M Prestolite - #8-76, 8-762, VBE-6001A, VBE-6101, VBE-6201A, VBO-4602E, VBO-4602V Fits: Studebaker Car - 6 Cyl. 1952-1955 (All with Autolite Generator), 8 Cyl. 1952-1955 (All with Autolite Generator)</p>	
B8002-006	12-Volt Voltage Regulator	\$67.50
	<p>12 Volt, 3 Terminal, Negative Ground, Voltage Regulator Fits: Studebaker - 1956-1958 PREMIUM QUALITY/ USA MADE</p>	
B8002-008	12-Volt Autolite Type Voltage Regulator	\$69.75
	<p>12 Volt, 3 Terminal, Flat Mounting (Premium Quality, Made in the USA) Replaces: Prestolite - #8-154, 8-414, 8-58, 8-59, 8-722, 8-85, GRX-722, VBO-4201E, VBO-4202A, VBO-4202B, VBO-4202P, VBO-4202R, VR-6301A, VRX-6010, VRX-6010A Chrysler - #1642333, 1842798, 1889944, 2095341, 2095531 Delco - #1972029, 1972061, A600, A600M, A605, A605M Fits: Studebaker - 6 Cyl. 1956 - 1959 w/ Autolite Generator, 8 Cyl. 1956 Speed Hawk</p>	

ALTERNATORS

B6001-001	12 Volt Alternator (1 Wire)	\$112.75	
63 Amp, Low Cut In, Specially Built For Tractors, Forklifts, & Other Low Engine Speed Applications			
B6001-002	12 Volt Alternator (1 Wire/ 3 Wire)	\$118.75	
63 Amp, With 1 Wire Or 3 Wire For Warning Lamp On Automobiles & Trucks			
B6001-005	6 Volt Alternator (1 Wire, Positive Ground)	\$166.50	
6 Volt, 40 Amp Alternator with Positive Ground, 1 Wire, 3/8" pulley			

STARTER SWITCHES

B5006-004	Starter Switch	\$11.75
	6 or 12 Volt Starter Mounted Manual Push Button Starter Switch Fits: Studebaker - 1937	
B5006-001	Starter Switch (Long Shaft)	\$12.75
	6 or 12 Volt Panel Mounted Manual Push Start Switch Replaces: Delco - #192119, D900, 450C Prestolite - #15-121, 15-122, 15-409, 15-45, 15-47, 15-50, 15-51, SW-2916, SW-4001, SW-4002, SW-4005, SW-4010, SW-4013, SW-4015, SW-4017, SW-4101, SWX-47 Fits: Studebaker - 1946	

LIGHT SWITCHES

B5010-018	Turn Signal Light Switch	\$73.50
	Universal Turn Signal Switch. Has right turn, left turn, and warning flasher modes. Metal Construction with Color Coded Wire Leads. Fuse, clamp ring, and instruction sheet included. Fits: Pre-1953 Vehicles	

WILLYS & JEEP

SPARK PLUG WIRE SETS

Our Spark Plug Wire Sets Come Fully Assembled with the Proper Type Wire & Terminals.

They are Custom Tailored to Look & Fit Like Original Factory Equipment.

Varieties include:

Cotton Braid Wire: Copper Core with a Cotton Jacket.

PVC Wire: Copper Core with a Rubber Jacket.

EPDM Wire (E): Hi Performance Premium Conductor with a Tinned Copper Core, EPDM Silicone Insulation, and a Rubber Jacket.

Suppression Wire (S): for Electronic Ignition and is Spiral Wound, Low-Ohm, with EPDM Silicone Insulation and a Rubber Jacket.

Cotton Braid Suppression Wire (CS): also for Electronic Ignition, as Suppression Wire, but has an additional layer of Cotton Braid & Lacquer to replicate the vintage look, as well.



Willys 1940-1952

MB GPW CJ2A CJ3A 134L 4 Cyl, Flathead

4 Cyl. Tailored Spark Plug Wire Set

B1105-001	Original Type Cotton Braid Wire	\$35.00
B1105-001E	EPDM Wire	\$38.00
B1105-001S	Suppression Wire	\$38.00
B1105-001CS	Cotton Suppression Wire	\$60.25

Willys 1953-1955

CJ3B CJ5 134F 4 Cyl, overhead valve

4 Cyl. Tailored Spark Plug Wire Set

B1105-002	Original Type Cotton Braid Wire	\$35.00
B1105-002E	EPDM Wire	\$38.00
B1105-002S	Suppression Wire	\$38.00
B1105-002CS	Cotton Suppression Wire	\$60.25

Willys 1956-1971

CJ3B CJ5 134F 4 Cyl, overhead valve

4 Cyl. Tailored Spark Plug Wire Set

B1105-003	Original Type PVC Wire	\$46.00
B1105-003E	EPDM Wire	\$55.50
B1105-003S	Suppression Wire	\$55.50

Willys 1949-1955 6 Cyl, Aero Falcon,

Aero Lark, & Station Wagon

6 Cyl. Tailored Spark Plug Wire Set

B1105-004	Original Type Cotton Braid Wire	\$50.75
B1105-004E	EPDM Wire	\$55.50
B1105-004S	Suppression Wire	\$55.50

TUNE UP PARTS

Jeep CJ2A

with Prestolite Distributor #IAD-4041

	B4001-005	\$9.75
	Points Replaces: #A81	
	B4002-006	\$7.50
	Condenser Replaces: #2-31, 2-38, 2-42, 2-95, IAT-1125S, IAT-3076BS, IBB-2042SS-1, IBB-2042-SS3, IG-3927F, IG-3927G, IG-3927K, IG-3927R	
	B4003-003	\$21.00
	Distributor Cap Made in the USA (Brass Contacts) Replaces: #C110	
	B4004-003	\$5.25
	Rotor Premium Grade, Made in USA Replaces: #D121	

Jeep 4 Cylinder 1960-1967

with Prestolite Distributor #IAT-4405

	B4001-017	\$6.50
	Points Replaces: #IBP-2040L, IBP-3028BS, 1-33, 1-47V, 1-48	
	B4002-006	\$7.50
	Condenser Replaces#2-31, 2-38, 2-42, 2-95, IAT-1125S, IAT-3076BS, IBB-2042SS-1, IBB-2042-SS3, IG-3927F, IG-3927G, IG-3927K, IG-3927R	
	B4003-053	\$16.00
	Cap Replaces: #IAT-1041, 3-5	
	B4004-040	\$6.25
	Rotor Premium Grade, Made in the USA Replaces: #IBT-1016C, 4-23	

Jeep 4 Cylinder 1960-1967 with Prestolite Distributor #IAY-4401 & 1968-1969 All		
	B4001-005	\$9.75
	Points Replaces: #1-4, 1-8, 1-9, 1-20, 1-22, 1-45, IAD-3128S, IGP-3028ES, IGP3028FS, IGS2224L, IGW3028AS	
	B4002-006	\$7.50
	Condenser Replaces: #2-31, 2-38, 2-42, 2-95, IAT-1125S, IAT-3076BS, IBB-2042SS-1, IBB-2042-SS3, IG-3927F, IG-3927G, IG-3927K, IG-3927R	
	B4003-053	\$16.00
	Cap Replaces: #IAT-1041, 3-5	
	B4004-040	\$6.25
	Rotor Premium Grade, Made in the USA Replaces: #IBT-1016C, 4-23	

Jeep 6 Cylinder 1975-1977 with Prestolite Electronic Distributor		
	B4004-043	\$5.75
	Rotor Replaces: #8126320, 4-91, 4-97, IBR-1017C, IBR-1017D	

Jeep 6 Cylinder with Motorcraft Distributor: 1980-1981 (All), 1982 (258, 2.4L Eng. Cherokee, Pickup J series, Wagoneer), 1983-1990 (All)		
	B4003-073	\$30.00
	Cap Replaces: #3230457	
	B4004-031	\$7.00
	Rotor Replaces: #3230821, F-405	

ELECTRONIC IGNITION CONVERSION KITS

Replaces Points & Condenser





Willys & Jeep 4 Cyl. 1940-1959 All with Autolite Distributor #IAD-4008, 1951 with IGC Distributor		
B9600-195	12 Volt Negative Ground	\$175.45
B9600-195N6	6 Volt Negative Ground	\$185.95

Willys 6 Cyl. 1940.1948 with Autolite Distributor #IGC-4729A		
B9600-070A	12 Volt Negative Ground	\$195.95
B9600-070AP6	6 Volt Positive Ground	\$206.45

CUTOUT RELAYS & VOLTAGE REGULATORS

Note: Due to modern battery design, voltage regulators can't be used to charge low or dead batteries. Doing so will destroy the voltage regulator and void the warranty.

B8001-001	6-Volt Cutout Relay	\$19.50
	15 Amps, 6 Volt Works Positive or Negative Ground Replaces: Autolite - #CB4014, C4012(9-5), C4012(9-4), C4012(9-1), R40061 Delco - #266P, 266N, 265P, 265N, 5015850, 812970, 265J, 820845, 812971, 1116816, 265G, 265H, 1116755, 1116751, 1116809DR, 265B, 1842859, 265C, 1867781, 265F, 265D Fits: Willys - 4, 6, 8 Cyl. 1930-1937	

B8001-002	Electronic Cutout Relay	\$19.50
	25 Amp, Works with 6, 12, or 24 Volts. & Positive or Negative Ground Replaces: Autolite - #CB4014, C4012(9-5), C4012(9-4), C4012(9-1), R40061 Delco - #266P, 266N, 265P, 265N, 5015850, 812970, 265J, 820845, 812971, 1116816, 265G, 265H, 1116755, 1116751, 1116809DR, 265B, 1842859, 265C, 1867781, 265F, 265D Fits: Willys - 4, 6, 8 Cyl. 1930-1937	

B8002-008	12-Volt Autolite Type Voltage Regulator	\$69.75
	12 Volt, 3 Terminal, Flat Mounting (Premium Quality, Made in the USA) Replaces: Prestolite - #8-154, 8-414, 8-58, 8-59, 8-722, 8-85, GRX-722, VBO-4201E, VBO-4202A, VBO-4202B, VBO-4202P, VBO-4202R, VR-6301A, VRX-6010, VRX-6010A Chrysler - #1642333, 1842798, 1889944, 2095341, 2095531 Delco - #1972029, 1972061, A600, A600M, A605, A605M Fits: Jeep - 1953 - 1966 (Except GGW, GDZ Generator)	

B8002-037	6-Volt Autolite Type Voltage Regulator	\$141.75
	6 Volt, 3 Terminal, Flat Mounting (Premium Quality, Made in the USA) Replaces: Prestolite - #8-26, 8-417, VRP4005A Fits: Willys - 1945-1958 All	

IDENTIFICATION TAGS

B9013-001	Small Autolite I.D. Tag (Blank)	\$7.00
	Small Autolite I.D. Tag (Stamped)	\$14.25
	2 5/16" Long, Black I.D. Tag for Distributors, Starters, & Generators with Rivets	

B9013-002	Large Autolite I.D. Tag (Blank)	\$7.00
	Large Autolite I.D. Tag (Stamped)	\$14.25
	2 15/16" Long, Black I.D. Tag for Distributors, Starters, & Generators with Rivets	

ALTERNATORS

B6001-001	12 Volt Alternator (1 Wire)	\$112.75	
63 Amp, Low Cut In, Specially Built For Tractors, Forklifts, & Other Low Engine Speed Applications			
B6001-002	12 Volt Alternator (1 Wire/ 3 Wire)	\$118.75	
63 Amp, With 1 Wire Or 3 Wire For Warning Lamp On Automobiles & Trucks			
B6001-005	6 Volt Alternator (1 Wire, Positive Ground)	\$166.50	
6 Volt, 40 Amp Alternator with Positive Ground, 1 Wire, 3/8" pulley			

STARTER SWITCHES

B5006-001	Starter Switch (Long Shaft)	\$12.75
	6 or 12 Volt Panel Mounted Manual Push Start Switch Replaces: Delco - #192119, D900, 450C Prestolite - #15-121, 15-122, 15-409, 15-45, 15-47, 15-50, 15-51, SW-2916, SW-4001, SW-4002, SW-4005, SW-4010, SW-4013, SW-4015, SW-4017, SW-4101, SWX-47 Fits: Willys - 1933-1936, 1945-1950 WITH MZ4113 Starter, & 4 Cyl. 1953-1957 With MCH6207 Starter	

FLASHERS

B9017-040	6-Volt Thermal Flasher	\$9.75
	6-Volt Thermal Flasher, Three Terminal Replaces: #535 Jeep Fits: 1933-60	

WILLYS KNIGHT

BATTERY CABLES



Our Battery Cables are made from the Proper Gauge Copper, as either **Black Cotton Braided Wire** or **PVC Wire** (whichever is correct for the application), using Soldered & Heat Sealed Brass or Copper Terminals.

Willys Knight 1928 Model 704 Coupe

B2108-001	Positive Battery Cable	\$41.00
B2000-004	Negative Ground Strap	\$10.50
B2108-002	Switch to Starter Cable	\$51.00
with Original Armor Cover		

Tune Up Parts

Willys Knight 6 Cylinder 1930

	B4001-002	\$14.75
	Points Replaces: #IGW-3028S, 1-31	
B4002-002		\$4.75
	Condenser Replaces: #2-23, 2-31, 2-32, 2-34, 2-38, 2-42, IAT-2015L, IAT-2015R, IAT-3076AS, IAT-3076BS, IAT-3076D, IAT-3076DS, IAT-3076L, IAT-3076LA, IAT-3076R, IAT-3076RA, IBB-2015L, IBB-2015R, IBB-2042-SS, IBB-2042SS-1, IBB-2042-SS3, IG-2671F, IGH-3076, IGW-3139, 2098058, 3420600	
	B4003-057	\$19.75
	Cap Replaces: #IG-1323, 3-9	
	B4004-038	\$21.75
	Rotor Replaces: #IG-1320, 4-8	

*For 6-Volt Ignition Coils & Accessories, see p.44

WILLYS OVERLAND

WHIPPET

SPARK PLUG WIRE SETS

Our Spark Plug Wire Sets Come **Fully Assembled with the Proper Type Wire & Terminals.**

They are Custom Tailored to Look & Fit Like Original Factory Equipment.



Varieties include:

Cotton Braid Wire: Copper Core with a Cotton Jacket.

EPDM Wire (E): Hi Performance Premium Conductor with a Tinned Copper Core, EPDM Silicone Insulation, and a Rubber Jacket.

Willys Whippet 1930

6 Cyl. Tailored Spark Plug Wire Set

B1108-002	Original Type Cotton Braid Wire	\$50.75
B1108-002E	EPDM Wire	\$55.50

Willys Overland 1931 Model 97

6 Cyl. Tailored Spark Plug Wire Set

B1108-003	Original Type Cotton Braid Wire	\$65.00
------------------	--	----------------

Willys Overland 1940 L Head



4 Cyl. Tailored Spark Plug Wire Set

B1108-001	Original Type Cotton Braid Wire	\$35.00
B1108-001E	EPDM Wire	\$38.00



Tune Up Parts

Willys Whippet 4 Cylinder All With IGB-4001

Distributor

	B4001-002	\$14.75
	Points Replaces: #IGW-3028S, 1-31	
B4002-002		\$4.75
	Condenser Replaces: #2-23, 2-31, 2-32, 2-34, 2-38, 2-42, IAT-2015L, IAT-2015R, IAT-3076AS, IAT-3076BS, IAT-3076D, IAT-3076DS, IAT-3076L, IAT-3076LA, IAT-3076R, IAT-3076RA, IBB-2015L, IBB-2015R, IBB-2042-SS, IBB-2042SS-1, IBB-2042-SS3, IG-2671F, IGH-3076, IGW-3139, 2098058, 3420600	



MOTORCYCLE & SCOOTER HARLEY-DAVIDSON TUNE UP PARTS



	B4003-062	\$21.50
	Cap Replaces: #IGB-1001, 3-14	
	B4004-016	\$9.50
	Rotor Premium Grade, USA Replaces: #IGB-1002, 4-12	



*For 6-Volt Ignition Coils & Accessories, see p.44



Willys Whippet 6 Cylinder 1928-1932 Model 97, 98, 98A (All With IGB-4020A, IGB-4032 Distributor)		
	B4001-002	\$14.75
	Points Replaces: #IGW-3028S, 1-31	
	B4002-005	\$9.75
	Condenser Replaces: #2-24, 2-35, 2-22, 2-23	
	B4003-027	\$21.75
	Cap Replaces: #ICB-1240, 3-20	
	B4004-004	\$11.50
	Rotor Premium Grade, Made in the USA Replaces: #4-15, IGB-1239	

*For 6-Volt Ignition Coils & Accessories, see p.44

Harley-Davidson 1949-1976 (G, K, KH, KHK, With 750, 900cc), & 1970 XLCH (With 1000cc)		
	B4001-006	\$11.75
	Points Replaces: #1882022	
	B4002-001	\$4.75
	Condenser Replaces: #1928111, D-203, 1869704, D-200	

Harley-Davidson 1970-1979 Model 74 With Dist, 1971-1979 Sportster XL, XLH, XLCH With dist., (900 & 1000cc), 1970-1979 Electra Glide With Dist (1200cc), 1970-1979 Super Glide FX, FXE, (1200cc)		
	B4001-012	\$4.75
	Points Replaces: #D108P	
	B4002-001	\$4.75
	Condenser Replaces: #1928111, D-203, 1869704, D-200	

Harley-Davidson WICO Magneto #XV12922		
	B4011-004	\$17.75
	Points Replaces: #1-5008, 1-5111, FXH-2100B, FXH-2400B, X5996	
	B4012-002	\$13.75
	Condenser Replaces: #2-5007, X5614, X6916	
	B4017-040	\$2.75
	Condenser Clamp Replaces: #94-5167	

	B4014-006	\$8.25
	Rotor Replaces: #4-5018, FXH1008, X5531	
	B4017-007	\$12.50
	Impulse Spring Replaces: #94-5016	

INDIAN

TUNE UP PARTS

Indian Chief All with Autolite Distributor #IGW-4053		
	B4001-002	\$14.75
	Points Replaces: #IGW-3028S, 1-31	
	B4002-005	\$9.75
	Condenser Replaces: #2-24, 2-35, 2-22, 2-23	
	B4004-016	\$9.50
	Rotor Premium Grade, USA Replaces: #IGB-1002, 4-12	
Distributor Cap		
B4003-080	Limited Edition Original Brown	\$27.75
B4003-023	Black	\$18.25
	Available in Original Brown or Black. Premium Quality/ Made in the USA (Brass Contacts) Replaces: #IGB-1065C, 3-15, 3-49 #IGW-4199B, YF6-F	

IDENTIFICATION TAGS

	B9013-001	Small Autolite I.D. Tag (Blank)	\$7.00
		Small Autolite I.D. Tag (Stamped)	\$14.25
		2 5/16" Long, Black I.D. Tag for Distributors, Starters, & Generators with Rivets	

	B9013-002	Large Autolite I.D. Tag (Blank)	\$7.00
		Large Autolite I.D. Tag (Stamped)	\$14.25
		2 15/16" Long, Black I.D. Tag for Distributors, Starters, & Generators with Rivets	

CUTOUT RELAYS & VOLTAGE REGULATORS

Note: Due to modern battery design, voltage regulators can't be used to charge low or dead batteries. Doing so will destroy the voltage regulator and void the warranty.

B8001-001	6-Volt Cutout Relay	\$19.50
	15 Amps, 6 Volt Works Positive or Negative Ground Replaces: Autolite - #CB4014, C4012(9-5), C4012(9-4), C4012(9-1), R40061 Delco - #266P, 266N, 265P, 265N, 5015850, 812970, 265J, 820845, 812971, 1116816, 265G, 265H, 1116755, 1116751, 1116809DR, 265B, 1842859, 265C, 1867781, 265F, 265D Fits: Indian - Various Models	

B8001-002	Electronic Cutout Relay	\$19.50
	25 Amp, Works with 6, 12, or 24 Volts. & Positive or Negative Ground Replaces: Autolite - #CB4014, C4012(9-5), C4012(9-4), C4012(9-1), R40061 Delco - #266P, 266N, 265P, 265N, 5015850, 812970, 265J, 820845, 812971, 1116816, 265G, 265H, 1116755, 1116751, 1116809DR, 265B, 1842859, 265C, 1867781, 265F, 265D Fits: Indian - Various Models	

6-Volt Delco Type Voltage Regulator		
B8002-025	Premium Quality, Made in the USA	\$118.25
B8002-046	Standard Quality	\$34.75
	6 Volt, 3 Terminals, Curved Mounting Bracket Regulator, <i>Generator Mounted</i> Replaces: Delco - #1118786, 1972234, A617M Prestolite - #GRX-406, GRX-407 Fits: Indian - Various Models	

VINCENT

Vincent Model B, C Motorcycle

B3112-001	Complete Wire Harness	\$191.00
------------------	------------------------------	-----------------



MARINE PRODUCTS

TUNE UP PARTS

ELGIN (Chrysler Outboard)

Elgin (Chrysler, West Bend Outboard)

5 HP model 571.5861 with WICO Magneto Type FW2128
 5 HP model 571.5862 with WICO Magneto Type FW2234
 2.0 HP Model 571.58202 & 571.58211 with WICO Magneto Type FW2195

	B4001-018	\$27.99
	Points Replaces: #1-5009, X7046	
	B4012-007	\$13.25
	Condenser *Call for Availability* Replaces: X-5463	

Elgin (Chrysler, West Bend Outboard)



Magneto Type FW1723B, FW1725E, FW2127



	B4001-018	\$27.99
	Points Replaces: #1-5009, X7046	
	B4012-007	\$13.25
	Condenser *Call for Availability* Replaces: X-5463	
	B4015-001	\$41.75
	Coil *Call for Availability* Replaces: #X4943, X5460, X7120, X7345, 5-5009, 5-5015	

FORD (Inboard Engine)

Ford Interceptor 8 Cyl. 351W Marine

Regular Roation with Prestolite Distributor #IBM7019, IBM-7020

	B4001-034	\$9.00
	Points Replaces: #IAZ-2040L, IAZ-2040LS (1-43), IGP-3028YS (1-18), IGW-3028HS (1-24, 1-42), IGW-3028NS, IGW-3028PS (1-30)	
	B4004-041	\$7.75
	Rotor Replaces: #4-95, 4-98, 493070C1	

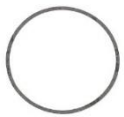
B4002-002	\$4.75
	Condenser Replaces: #2-23, 2-31, 2-32, 2-34, 2-38, 2-42, IAT-2015L, IAT-2015R, IAT-3076AS, IAT-3076BS, IAT-3076D, IAT-3076DS, IAT-3076L, IAT-3076LA, IAT-3076R, IAT-3076RA, IBB-2015L, IBB-2015R, IBB-2042-SS, IBB-2042SS-1, IBB-2042-SS3, IG-2671F, IGH-3076, IGW-3139, 2098058, 3420600
	B4003-069
	Cap Replaces: #IBM-1008
	B4008-021
	Cap Gasket (Used with #B4003-069)

ELECTRONIC IGNITION CONVERSION KIT

8 Cyl. Ford 351W Inboard Motor (Regular Rotation with Prestolite Distributor #IBM-70019, IBM-7020)

B9600-074	12 Volt Negative Ground	\$91.55
------------------	-------------------------	----------------

OUTBOARD MARINE COMPANY (OMC)

OMC 6 Cyl. GM 262 Engine

with Prestolite Distributor #IBM-7021

	B4001-034	\$9.00
	Points Replaces: #IAZ-2040L, IAZ-2040LS (1-43), IGP-3028YS (1-18), IGW-3028HS (1-24, 1-42), IGW-3028NS, IGW-3028PS (1-30)	
B4002-002	\$4.75	
	Condenser Replaces: #2-23, 2-31, 2-32, 2-34, 2-38, 2-42, IAT-2015L, IAT-2015R, IAT-3076AS, IAT-3076BS, IAT-3076D, IAT-3076DS, IAT-3076L, IAT-3076LA, IAT-3076R, IAT-3076RA, IBB-2015L, IBB-2015R, IBB-2042-SS, IBB-2042SS-1, IBB-2042-SS3, IG-2671F, IGH-3076, IGW-3139, 2098058, 3420600	
	B4003-068	\$27.00
	Cap Replaces: #IBM-1009, 3-149	
	B4004-042	\$5.50
	Rotor Replaces: #4-91, 4-92	

MAIL ORDER FORM (CUT OFF & FILL OUT)

THE BRILLMAN COMPANY

Website: www.brillman.com

THE BRILLMAN COMPANY
2328 PEPPER ROAD
MOUNT JACKSON, VA 22842

PHONE 888-274-5562
FAX 540-477-2980

DATE _____

NAME _____

ADDRESS _____

CITY _____

STATE _____ ZIP CODE _____

PHONE NO _____

VISA / MASTERCARD, AM EXPRESS, & DISCOVER
CARD # _____

EXPIRATION DATE (MONTH/YEAR) _____

CVV2 CODE (SECURITY CODE) _____
(3 DIGIT ON BACK OF VISA, MASTERCARD, & DISCOVER,
4 DIGITS ON FRONT OF AM EXPRESS)

ITEMS ORDERED:

QTY.	ITEM	\$	EXT \$
QTY.	ITEM	\$	EXT \$
QTY.	ITEM	\$	EXT \$
QTY.	ITEM	\$	EXT \$
QTY.	ITEM	\$	EXT \$
QTY.	ITEM	\$	EXT \$
QTY.	ITEM	\$	EXT \$
QTY.	ITEM	\$	EXT \$
QTY.	ITEM	\$	EXT \$
QTY.	ITEM	\$	EXT \$
QTY.	ITEM	\$	EXT \$
QTY.	ITEM	\$	EXT \$

SUB TOTAL \$ _____

+ Sales Tax \$ _____

+ Shipping \$11.50

TOTAL \$ _____

www.brillman.com

CALL TOLL FREE
888-274-5562

Keep your project
looking classic, with a
modern flair!







Upgrade your distributor
to an electronic ignition
today with our quality
Low Ohm Suppression
Spark Plug Ignition
Wire!

** Electronic ignition conversion kits available for only select applications

Which Ignition Coils Should I Buy?

Here's a breakdown of our Ignition coils and the application used. The higher the rated output voltage, the hotter spark you'll get. Pertronix Ignitor technology sustains energy at higher RPM's in their coils.

System Voltage	Resistance	Application For Pertronix Products (Number of Engine Cylinders)	30,000 Volts Standard Quality Coils 	40,000 Volts Pertronix Ignitor Coils 	55,000 Volts Brillman Hot Coils 	60,000 Volts Brillman Super Stinger Coils 
12V	3 Ω	1, 2, 4, 6	EB40E*	B40501 B40511 B40611	EB40*	EB40SS*
12V	1.5Ω	8	EB30E**	B40001 B40011 B40111	EB30**	EB30SS**
6V	1.5Ω	1, 2, 4, 6	EB1E	B40001 B40011 B40111	EB1	EB1SS
6V	0.6Ω	8		B45001*** B45011*** B45111***		

* Does Not Require Ballast Resistor. Can Be Wired Directly to 12 Volts.

**Requires Ballast Resistor - Order B4008-006

***45,000 Volts

Electronic Ignition Disclaimer

WARNING: Electronic Ignition Conversion Kits are polarity sensitive. Any attempt to start the tractor or vehicle with the polarity reversed will immediately destroy the unit. Make sure you have verified the proper polarity set-up (Positive Ground or Negative Ground) of your tractor or vehicle before purchasing an Electronic Ignition Conversion Kit. If you are unqualified to carry out this conversion, please have a professional tractor or automotive repair shop make the change. Any negligent destruction of the Electronic Ignition Unit due to improper installation or electrical malfunctions will immediately void the warranty. Please contact Pertronix Performance products for all queries about warranty returns for Pertronix products only.

As per Pertronix Performance Products, all electronic ignition kits should be used with Low Ohm Suppression Spark Pug Ignition wire. Use of copper or any other material will damage the electronic components and void all warranty of the Pertronix ignitor series electronic ignition kits.



We have what you need for:
Allis Chalmers
Ford
IHC/Farmall
John Deere

Massey Ferguson
Minneapolis Moline
Oliver
Wisconsin
... and more!



Phone: 540-477-4112
Toll Free: 888-274-5562
Fax: 540-477-2980
Web: www.Brillman.com
Email: Info@Brillman.com

2328 Pepper Road
Mount Jackson, VA 22842

